

# International IR Rectifier

INSULATED GATE BIPOLAR TRANSISTOR

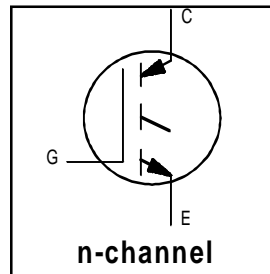
PD - 9.1585B

## IRG4PC40K

Short Circuit Rated  
UltraFast IGBT

### Features

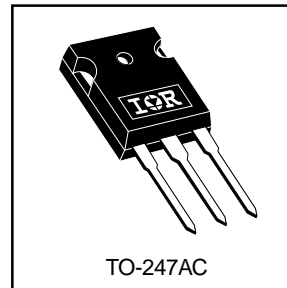
- Short Circuit Rated UltraFast: Optimized for high operating frequencies >5.0 kHz , and Short Circuit Rated to 10 $\mu$ s @ 125°C,  $V_{GE} = 15V$
- Generation 4 IGBT design provides higher efficiency than Generation 3
- Industry standard TO-247AC package



$V_{CES} = 600V$
$V_{CE(on) typ.} = 2.1V$
@ $V_{GE} = 15V, I_C = 25A$

### Benefits

- Generation 4 IGBTs offer highest efficiency available
- IGBTs optimized for specified application conditions



### Absolute Maximum Ratings

	Parameter	Max.	Units
$V_{CES}$	Collector-to-Emitter Voltage	600	V
$I_C @ T_C = 25^\circ C$	Continuous Collector Current	42	A
$I_C @ T_C = 100^\circ C$	Continuous Collector Current	25	
$I_{CM}$	Pulsed Collector Current ①	84	
$I_{LM}$	Clamped Inductive Load Current ②	84	
$t_{sc}$	Short Circuit Withstand Time	10	$\mu$ s
$V_{GE}$	Gate-to-Emitter Voltage	$\pm 20$	V
$E_{ARV}$	Reverse Voltage Avalanche Energy ③	15	mJ
$P_D @ T_C = 25^\circ C$	Maximum Power Dissipation	160	W
$P_D @ T_C = 100^\circ C$	Maximum Power Dissipation	65	
$T_J$	Operating Junction and	-55 to +150	$^\circ C$
$T_{STG}$	Storage Temperature Range		
	Soldering Temperature, for 10 sec.	300 (0.063 in. (1.6mm) from case)	
	Mounting torque, 6-32 or M3 screw.	10 lbf•in (1.1N•m)	

### Thermal Resistance

	Parameter	Typ.	Max.	Units
$R_{\theta JC}$	Junction-to-Case	—	0.77	$^\circ C/W$
$R_{\theta CS}$	Case-to-Sink, Flat, Greased Surface	0.24	—	
$R_{\theta JA}$	Junction-to-Ambient, typical socket mount	—	40	
Wt	Weight	6 (0.21)	—	g (oz)

## Electrical Characteristics @ $T_J = 25^\circ\text{C}$ (unless otherwise specified)

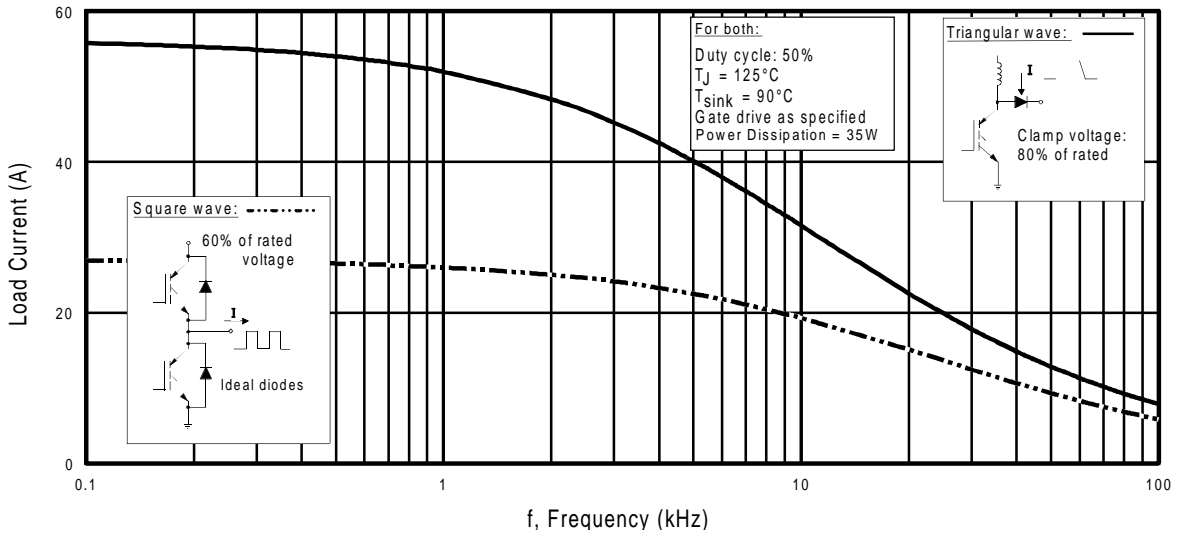
	Parameter	Min.	Typ.	Max.	Units	Conditions
$V_{(BR)CES}$	Collector-to-Emitter Breakdown Voltage	600	—	—	V	$V_{GE} = 0V, I_C = 250\mu A$
$V_{(BR)ECS}$	Emitter-to-Collector Breakdown Voltage ④	18	—	—	V	$V_{GE} = 0V, I_C = 1.0A$
$\Delta V_{(BR)CES}/\Delta T_J$	Temperature Coeff. of Breakdown Voltage	—	0.46	—	V/°C	$V_{GE} = 0V, I_C = 1.0mA$
$V_{CE(ON)}$	Collector-to-Emitter Saturation Voltage	—	2.10	2.6	V	$I_C = 25A$ $I_C = 42A$ $I_C = 25A, T_J = 150^\circ\text{C}$ $V_{GE} = 15V$ See Fig.2, 5
		—	2.70	—		
		—	2.14	—		
$V_{GE(th)}$	Gate Threshold Voltage	3.0	—	6.0		$V_{CE} = V_{GE}, I_C = 250\mu A$
$\Delta V_{GE(th)}/\Delta T_J$	Temperature Coeff. of Threshold Voltage	—	-13	—	mV/°C	$V_{CE} = V_{GE}, I_C = 250\mu A$
$g_{fe}$	Forward Transconductance ⑤	7.0	14	—	S	$V_{CE} = 100V, I_C = 25A$
$I_{CES}$	Zero Gate Voltage Collector Current	—	—	250	$\mu A$	$V_{GE} = 0V, V_{CE} = 600V$ $V_{GE} = 0V, V_{CE} = 10V, T_J = 25^\circ\text{C}$ $V_{GE} = 0V, V_{CE} = 600V, T_J = 150^\circ\text{C}$
		—	—	2.0		
		—	—	2000		
$I_{GES}$	Gate-to-Emitter Leakage Current	—	—	$\pm 100$	nA	$V_{GE} = \pm 20V$

## Switching Characteristics @ $T_J = 25^\circ\text{C}$ (unless otherwise specified)

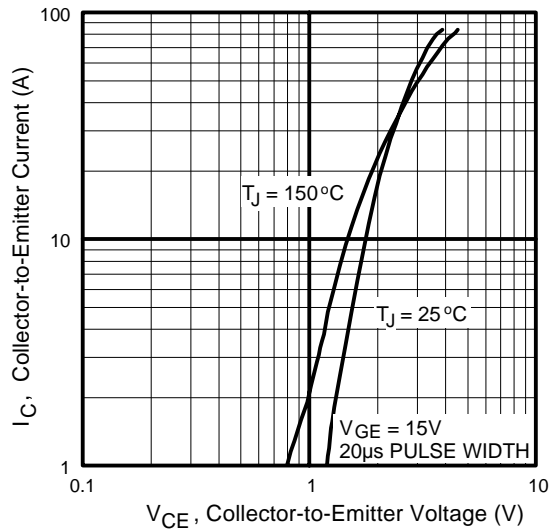
	Parameter	Min.	Typ.	Max.	Units	Conditions
$Q_g$	Total Gate Charge (turn-on)	—	120	180	nC	$I_C = 25A$ $V_{CC} = 400V$ $V_{GE} = 15V$ See Fig.8
$Q_{ge}$	Gate - Emitter Charge (turn-on)	—	16	24		
$Q_{gc}$	Gate - Collector Charge (turn-on)	—	51	77		
$t_{d(on)}$	Turn-On Delay Time	—	30	—	ns	$T_J = 25^\circ\text{C}$ $I_C = 25A, V_{CC} = 480V$ $V_{GE} = 15V, R_G = 10\Omega$ Energy losses include "tail" See Fig. 9,10,14
$t_r$	Rise Time	—	15	—		
$t_{d(off)}$	Turn-Off Delay Time	—	140	210		
$t_f$	Fall Time	—	140	210		
$E_{on}$	Turn-On Switching Loss	—	0.62	—	mJ	See Fig. 9,10,14
$E_{off}$	Turn-Off Switching Loss	—	0.33	—		
$E_{ts}$	Total Switching Loss	—	0.95	1.4		
$t_{sc}$	Short Circuit Withstand Time	10	—	—	$\mu s$	$V_{CC} = 400V, T_J = 125^\circ\text{C}$ $V_{GE} = 15V, R_G = 10\Omega, V_{CPK} < 500V$
$t_{d(on)}$	Turn-On Delay Time	—	30	—	ns	$T_J = 150^\circ\text{C}$ $I_C = 25A, V_{CC} = 480V$ $V_{GE} = 15V, R_G = 10\Omega$ Energy losses include "tail" See Fig. 11,14
$t_r$	Rise Time	—	18	—		
$t_{d(off)}$	Turn-Off Delay Time	—	190	—		
$t_f$	Fall Time	—	150	—		
$E_{ts}$	Total Switching Loss	—	1.9	—	mJ	
$L_E$	Internal Emitter Inductance	—	13	—	nH	Measured 5mm from package
$C_{ies}$	Input Capacitance	—	1600	—	pF	$V_{GE} = 0V$ $V_{CC} = 30V$ $f = 1.0MHz$ See Fig. 7
$C_{oes}$	Output Capacitance	—	130	—		
$C_{res}$	Reverse Transfer Capacitance	—	55	—		

### Notes:

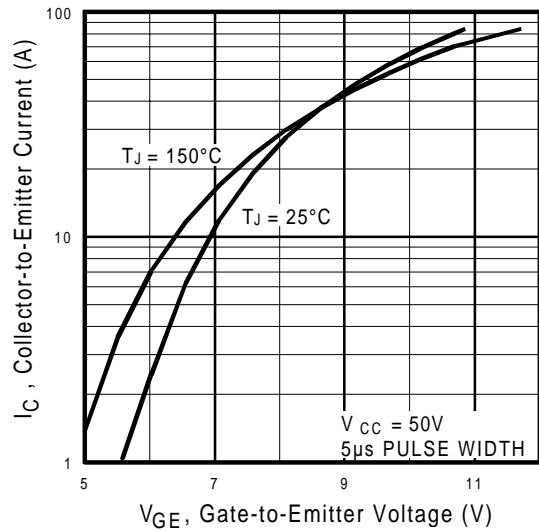
- |  |   |
|--|---|
| ① Repetitive rating; $V_{GE} = 20V$ , pulse width limited by max. junction temperature. ( See fig. 13b ) | ③ Repetitive rating; pulse width limited by maximum junction temperature. |
| ② $V_{CC} = 80\%(V_{CES})$ , $V_{GE} = 20V$ , $L = 10\mu H$ , $R_G = 10\Omega$ , (See fig. 13a)          | ④ Pulse width $\leq 80\mu s$ ; duty factor $\leq 0.1\%$ .                 |
|  | ⑤ Pulse width $5.0\mu s$ , single shot.                                   |



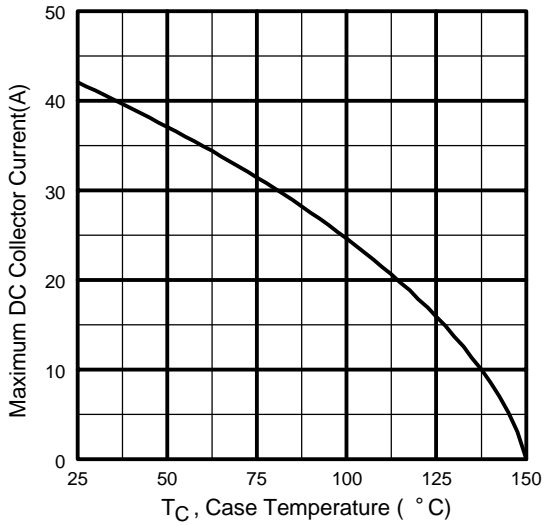
**Fig. 1 - Typical Load Current vs. Frequency**  
(Load Current =  $I_{RMS}$  of fundamental)



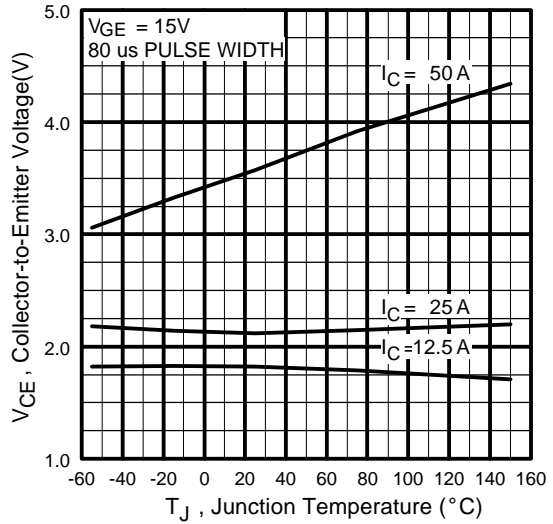
**Fig. 2 - Typical Output Characteristics**



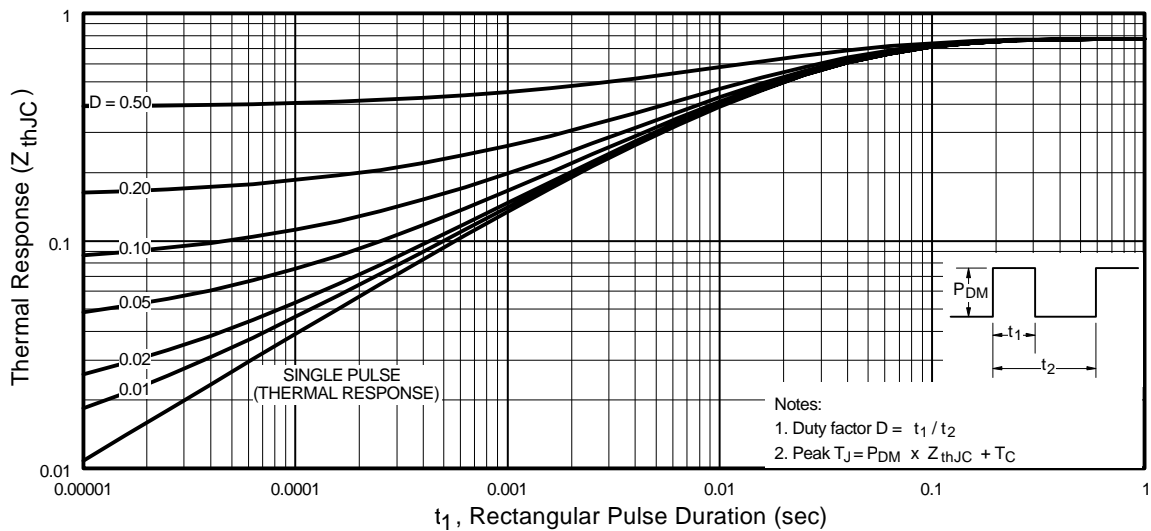
**Fig. 3 - Typical Transfer Characteristics**



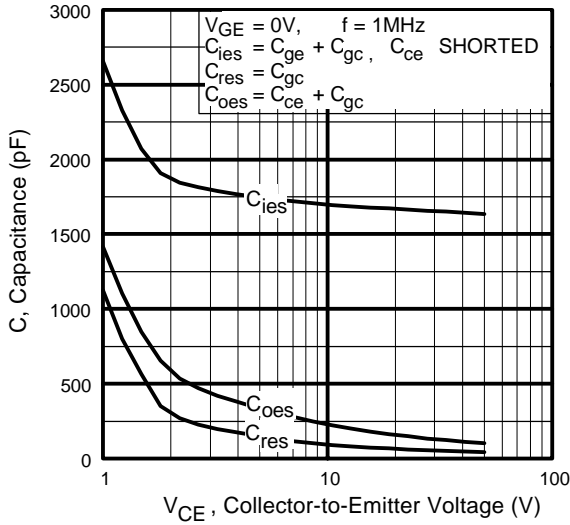
**Fig. 4** - Maximum Collector Current vs. Case Temperature



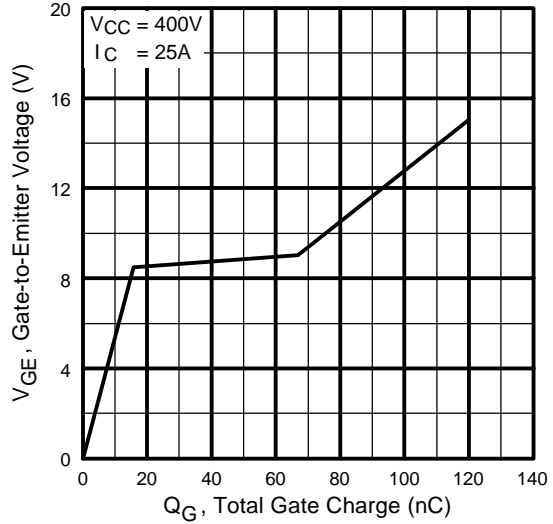
**Fig. 5** - Typical Collector-to-Emitter Voltage vs. Junction Temperature



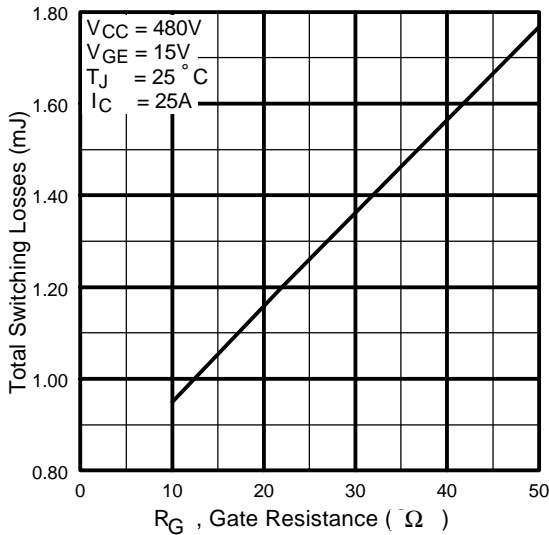
**Fig. 6** - Maximum Effective Transient Thermal Impedance, Junction-to-Case



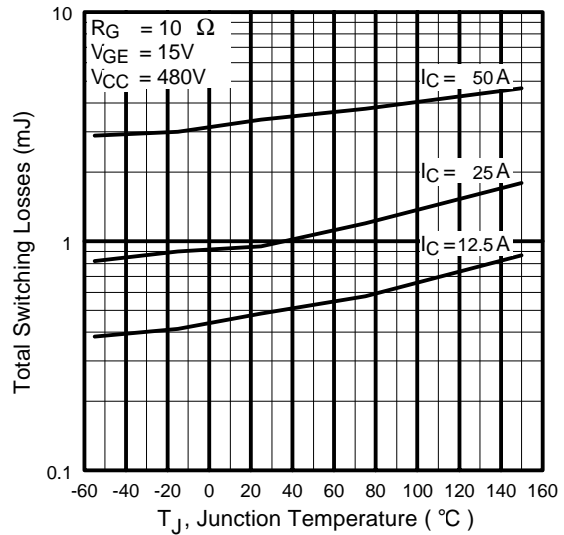
**Fig. 7** - Typical Capacitance vs. Collector-to-Emitter Voltage



**Fig. 8** - Typical Gate Charge vs. Gate-to-Emitter Voltage



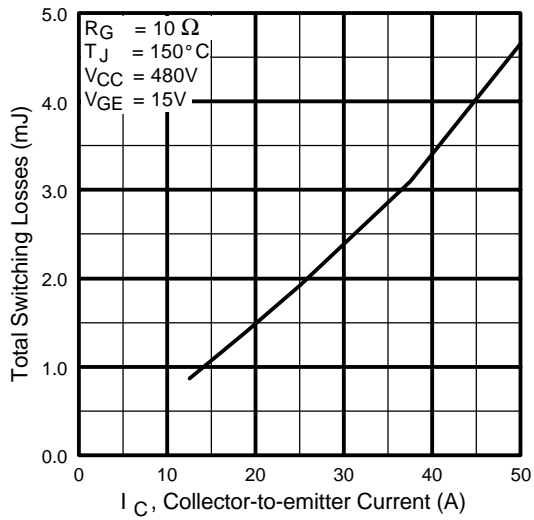
**Fig. 9** - Typical Switching Losses vs. Gate Resistance



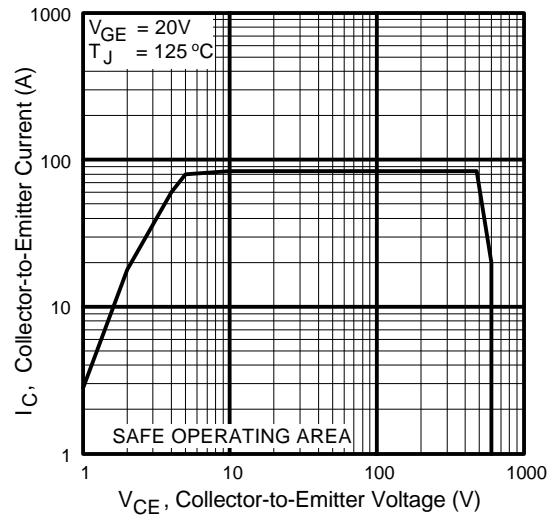
**Fig. 10** - Typical Switching Losses vs. Junction Temperature

# IRG4PC40K

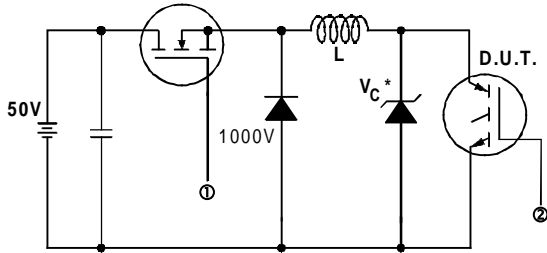
International  
**IR** Rectifier



**Fig. 11** - Typical Switching Losses vs. Collector-to-Emitter Current

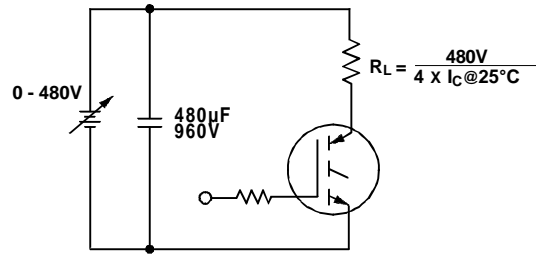


**Fig. 12** - Turn-Off SOA

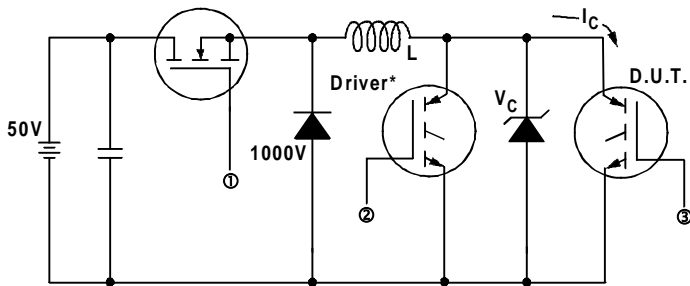


\* Driver same type as D.U.T.;  $V_c = 80\%$  of  $V_{ce(max)}$   
 \* Note: Due to the 50V power supply, pulse width and inductor will increase to obtain rated  $I_d$ .

**Fig. 13a** - Clamped Inductive Load Test Circuit

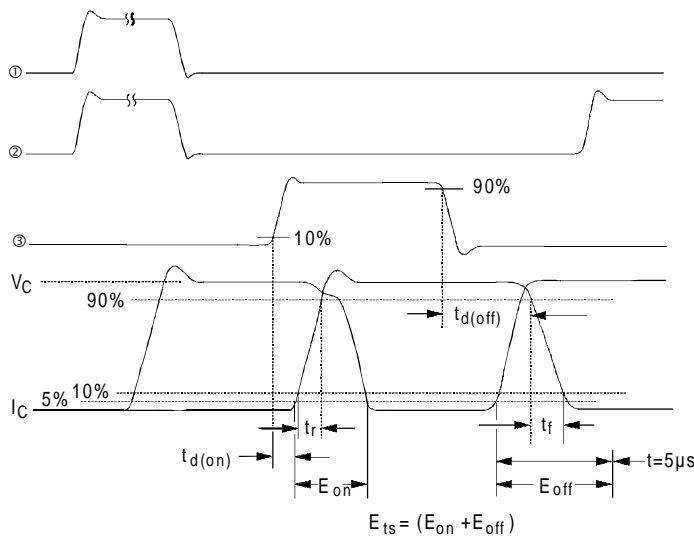


**Fig. 13b** - Pulsed Collector Current Test Circuit



**Fig. 14a** - Switching Loss Test Circuit

\* Driver same type as D.U.T.,  $V_C = 480V$

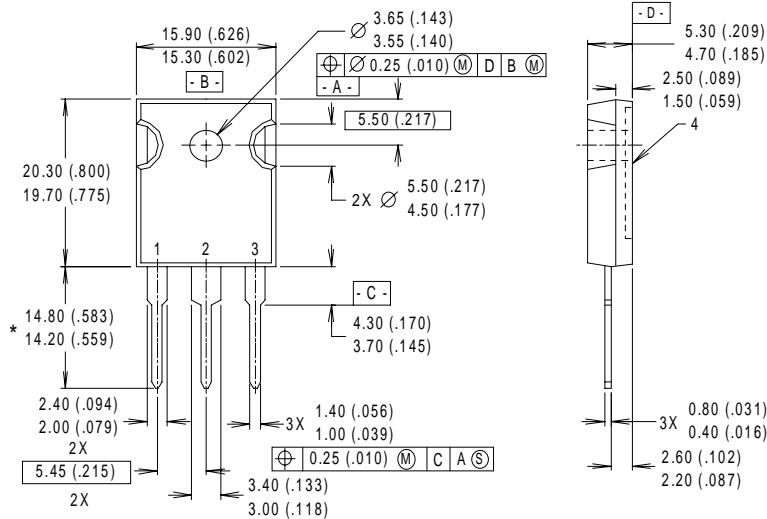


**Fig. 14b** - Switching Loss Waveforms

# IRG4PC40K

International  
**IR** Rectifier

## Case Outline and Dimensions — TO-247AC



- NOTES:
- 1 DIMENSIONS & TOLERANCING PER ANSI Y14.5M, 1982.
  - 2 CONTROLLING DIMENSION : INCH.
  - 3 DIMENSIONS ARE SHOWN MILLIMETERS (INCHES).
  - 4 CONFORMS TO JEDEC OUTLINE TO-247AC.

- LEAD ASSIGNMENTS
- 1 - GATE
  - 2 - COLLECTOR
  - 3 - EMITTER
  - 4 - COLLECTOR

\* LONGER LEADED (20mm) VERSION AVAILABLE (TO-247AD) TO ORDER ADD "E" SUFFIX TO PART NUMBER

**CONFORMS TO JEDEC OUTLINE TO-247AC (TO-3P)**

Dimensions in Millimeters and (Inches)

International  
**IR** Rectifier

**IR WORLD HEADQUARTERS:** 233 Kansas St., El Segundo, California 90245, USA Tel: (310) 252-7105

**IR EUROPEAN REGIONAL CENTRE:** 439/445 Godstone Rd, Whyteleafe, Surrey CR3 0BL, UK Tel: ++ 44 (0)20 8645 8000

**IR CANADA:** 15 Lincoln Court, Brampton, Ontario L6T3Z2, Tel: (905) 453 2200

**IR GERMANY:** Saalburgstrasse 157, 61350 Bad Homburg Tel: ++ 49 (0) 6172 96590

**IR ITALY:** Via Liguria 49, 10071 Borgaro, Torino Tel: ++ 39 011 451 0111

**IR JAPAN:** K&H Bldg., 2F, 30-4 Nishi-Ikebukuro 3-Chome, Toshima-Ku, Tokyo 171 Tel: 81 (0)3 3983 0086

**IR SOUTHEAST ASIA:** 1 Kim Seng Promenade, Great World City West Tower, 13-11, Singapore 237994 Tel: ++ 65 (0)838 4630

**IR TAIWAN:** 16 Fl. Suite D. 207, Sec. 2, Tun Haw South Road, Taipei, 10673 Tel: 886-(0)2 2377 9936

*Data and specifications subject to change without notice. 4/00*



Note: For the most current drawings please refer to the IR website at:  
<http://www.irf.com/package/>