



Cable drag chain systems

MP 3000

MP 3000

OPEN



- LOW-COST VARIANT
- CHAIN BRACKET WITH INTEGRATED STRAIN RELIEF

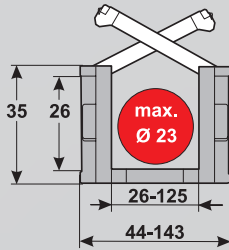

TECHNICAL DATA

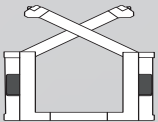

Loading side
Inside bend

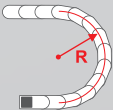

Available radii
50.0 – 300.0 mm

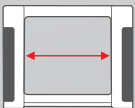

Available interior widths
With plastic frame bridge
26.0 – 125.0 mm

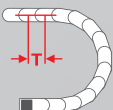

Pitch
T = 45.0 mm

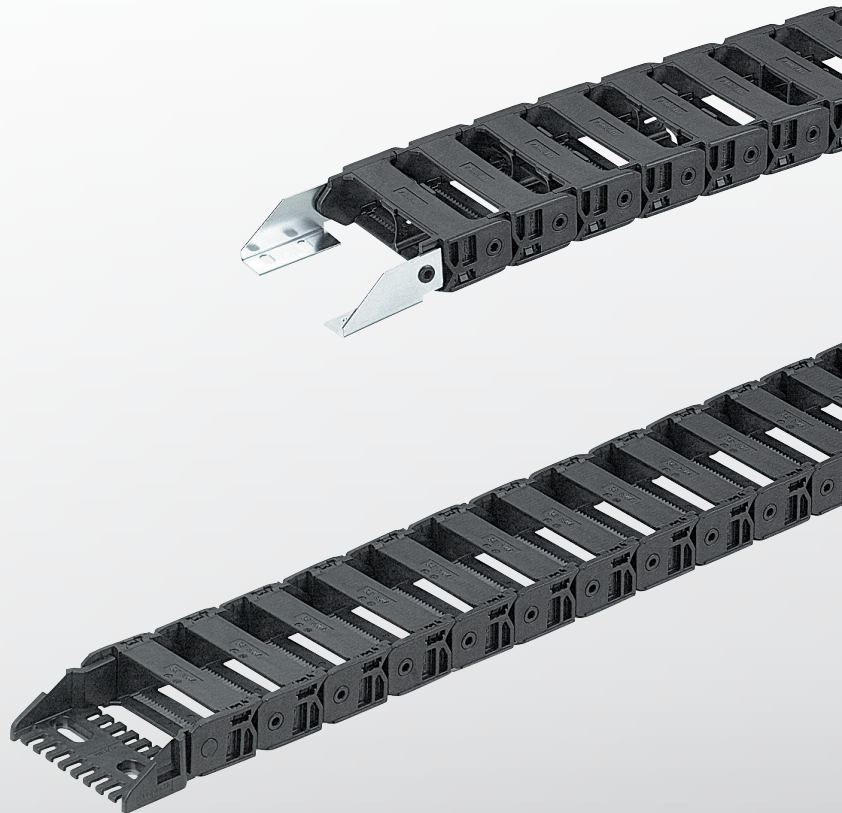

TECHNICAL SPECIFICATIONS

Travel distance gliding L_g max.	60.0 m
Travel distance self-supporting L_s max.	see diagram on page 5
Travel distance vertical, hanging L_{vh} max.	40.0 m
Travel distance vertical, upright L_{vs} max.	3.0 m
Rotated 90°, unsupported L_{90f} max.	0.7 m
Speed, gliding V_g max.	3.0 m/s
Speed, self-supporting V_s max.	6.0 m/s
Acceleration, gliding a_g max.	10.0 m/s ²
Acceleration, self-supporting a_s max.	15.0 m/s ²

Contact our engineering department to meet any higher requirements: efk@murrplastik.de



MATERIAL PROPERTIES

Standard material	Polyamide (PA) black
Service temperature	-30.0 – 120.0 °C
Gliding friction factor	0.3
Static friction factor	0.45
Fire classification	UL 94 HB

Other material properties on request.

SHELVING SYSTEM

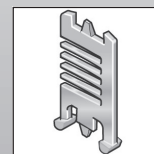

Separator TR

CHAIN BRACKET

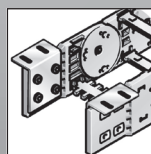

Chain bracket angle

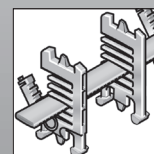

Shelving system RS

GUIDE CHANNELS

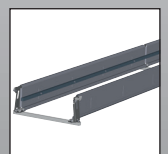

VAW stainless steel

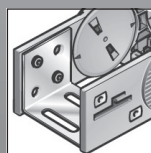

Chain bracket U-part

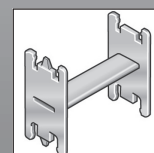

H-shaped shelf unit RE

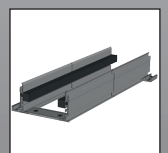

VAW aluminium

ORDERING KEY

Dimensions in mm [US inch]

Type code	Variation	Inside width	Outside width	Inside width	Outside width	Radius	Rail variant	Material	Chain length
0300 02	Frame bridge on outside of radius Frame bridge on inside bend Opens on inside of radius	026 [1.02]	044 [1.73]			050 [1.97]	0 Plastic, full-ridged with bias	0 Polyamide standard (PA/black)	
		037 [1.46]	055 [2.17]						
		056 [2.20]	074 [2.91]			070 [2.76]	1 Plastic, full-ridged without bias	1 UL94 / V0 (PA/oxide red)	
		062 [2.44]	080 [3.15]						
		076 [2.99]	094 [3.70]			095 [3.74]		5 Polypropylene (PP/blue)	
		087 [3.43]	105 [4.13]						
		101 [3.98]	119 [4.69]			120 [4.72]		7 EMC (PA/light grey)	
		125 [4.92]	143 [5.63]						
						150 [5.91]		9 Special version (on request)	
						200 [7.87]			
						300 [11.81]			

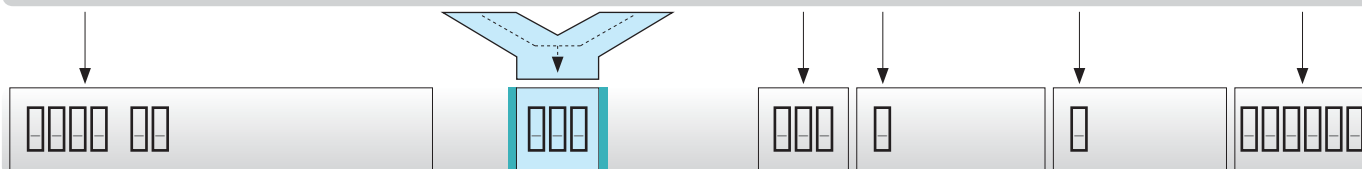

ORDER SAMPLE: 0300 02 026 050 0 0 1215

Frame bridge in outside bend, frame bridge in inside bend, can be opened from inside bend
 Inside width 26 mm; radius 50 mm
 Plastic bridge, full-ridged with bias, material black-coloured polyamide
 Chain length 1215 mm (27 links)

SELF-SUPPORTING LENGTH

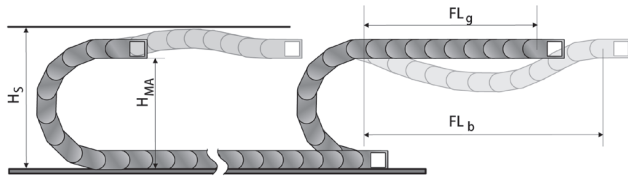

The self-supporting length is the distance between the chain bracket on the moving end and the start of the chain arch. The installation variant FL_g offers the lowest load and wear for the cable drag chain. The maximum travel parameters (speed and acceleration) can be applied for this variant.

- H_s = Installation height plus safety
- H_{MA} = Height of moving end connection
- FL_g = Self-supporting length, upper run straight
- FL_b = Self-supporting length, upper run bent

LOAD DIAGRAM FOR SELF-SUPPORTING APPLICATIONS

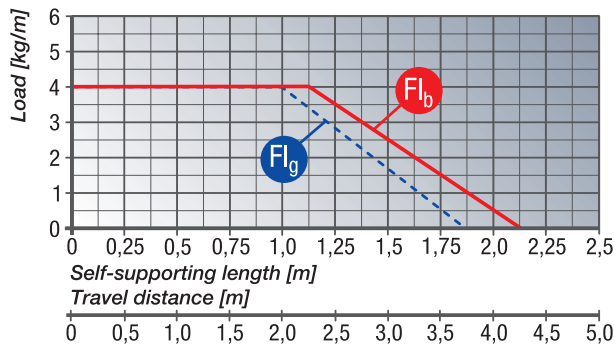

FL_g Self-supporting length, upper run straight
In the FL_g range, the chain upper run still has a bias, is straight or has a maximum sag of 60.0 mm.

FL_b Self-supporting length, upper run bent
In the FL_b range, the chain upper run has a sag of more than 60.0 mm, but this is still less than the maximum sag. Where the sag is greater than that permitted in the FL_b range, the application is critical and should be avoided. The self-supporting length can be optimized by using a support for the upper run or a more stable energy chain.

DETERMINING THE CHAIN LENGTH

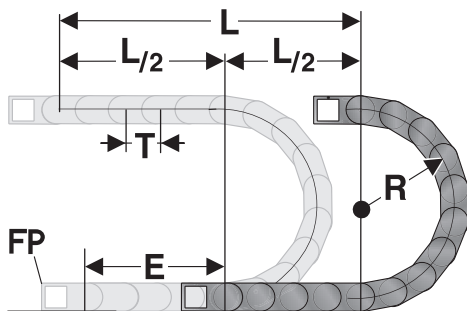

The fixed point of the cable drag chain should be connected in the middle of the travel distance. This arrangement gives the shortest connection between the fixed point and the moving consumer and thus the most efficient chain length.

Chain length calculation = $L/2 + \pi * R + 2 * T + E$
 $\approx 1 \text{ m chain} = 22 \text{ qty.} \times 45.0 \text{ mm links.}$

- E = distance between entry point and middle of travel distance
- L = travel distance
- R = radius
- T = Pitch 45.0 mm

EINBAUMASSE

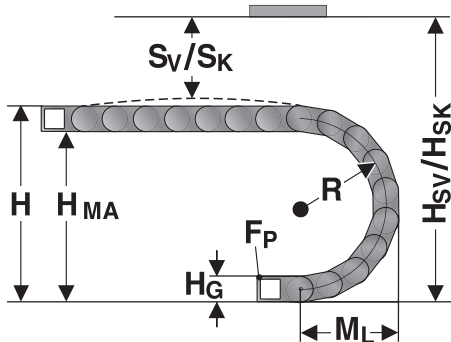

The moving end chain connection is to be screw fixed at height H_{MA} for the respective radius.

Concerning the installed dimensions, you must take into account whether the chain links are equipped with or without bias.

For chain links without bias, the „Installed height without bias H_{SK} “ value has to be taken into account.

If the chain links are equipped with a bias, the value „Installed height with bias H_{SV} “ has to be taken into account.

Radius R	50	70	95	120	150	200	300
Outside height of chain link (H_G)	35	35	35	35	35	35	35
Height of bend (H)	135	175	225	275	335	435	635
Height of moving end bracket (H_{MA})	100	140	190	240	300	400	600
Safety margin with bias (S_V)	45	45	45	45	45	45	45
Installation height with bias (H_{SV})	180	220	270	320	380	480	680
Safety margin without bias (S_K)	10	10	10	10	10	10	10
Installation height without bias (H_{SK})	145	185	235	285	345	445	645
Arc projection (M_L)	113	133	158	183	213	263	363

CHAIN BRACKET ANGLE KA 3000

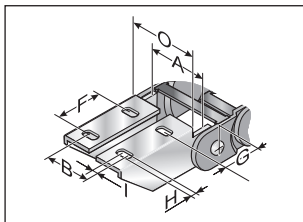

KA 300... (Inside up / down)

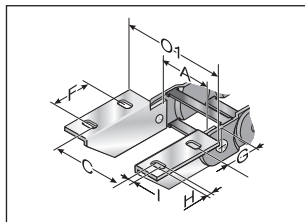

KA 300... (Outside up / down)

The chain bracket can be supplied either in galvanised sheet steel or stainless steel. To secure one cable drag chain, you will need two angle brackets (left and right) with a drilled hole and two angle brackets (left and right) with a bolt. The order numbers given below each comprise a left and right angle bracket.

Type	Order No.	Material	Inside width							Outside width KA	Outside width KA
			A mm	B mm	C mm	F mm	G mm	HØ mm	I mm		
KA 3008 Female end	0300000052	Sheet steel	26.0 – 125.0	A-8.5	A+22.5	25.0	21.0	6.5	45.0	A+18.0	A+40.0
KA 3008 Male end	0300000053	Sheet steel	26.0 – 125.0	A-3.5	A+31.0	25.0	21.0	6.5	45.0	A+9.0	A+40.0
KA 3009 Female end	0300000054	Stainless steel 1.4301	26.0 – 125.0	A-8.5	A+22.5	25.0	21.0	6.5	45.0	A+18.0	A+40.0
KA 3009 Male end	0300000055	Stainless steel 1.4301	26.0 – 125.0	A-3.5	A+31.0	25.0	21.0	6.5	45.0	A+9.0	A+40.0

CHAIN BRACKET U-PART KA 3000

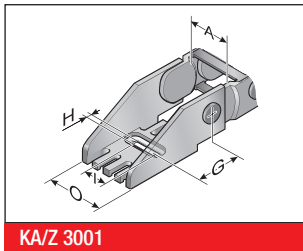

KA/Z 3001

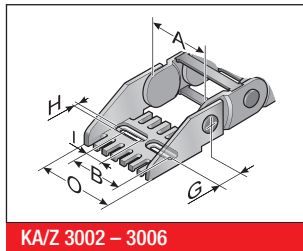

KA/Z 3002 – 3006

The type KA/Z 3001 – 3006 chain bracket is a plastic part with an extrusion-coated metal insert. The bracket is precisely adjusted to the respective chain width and only needs to be snapped in at the chain link. Please order one male and one female end bracket for each chain. The brackets should be fastened with M6 screws. The cables or tubes may be fastened with cable ties at the integrated strain relief of the chain bracket.

Type	Order No.	Material	Inside width					Outside width KA O mm
			A mm	B mm	G mm	HØ mm	I mm	
KA/Z 3001 female end	030000008000	Plastic with metal insert	26.0		31.5	6.5	18.5	A+18.0
KA/Z 3001 male end	030000008100	Plastic with metal insert	26.0		31.5	6.5	18.5	A+18.0
KA/Z 3002 female end	030000008200	Plastic with metal insert	37.0	A-7.0	31.5	6.5	7.5	A+18.0
KA/Z 3002 male end	030000008300	Plastic with metal insert	37.0	A-7.0	31.5	6.5	7.5	A+18.0
KA/Z 3002.5 female end	030000007600	Plastic with metal insert	56.0	A-8.0	31.5	6.5	7.5	A+18.0
KA/Z 3002.5 male end	030000007700	Plastic with metal insert	56.0	A-8.0	31.5	6.5	7.5	A+18.0
KA/Z 3003 female end	030000008400	Plastic with metal insert	62.0	A-7.0	31.5	6.5	18.5	A+18.0
KA/Z 3003 male end	030000008500	Plastic with metal insert	62.0	A-7.0	31.5	6.5	18.5	A+18.0
KA/Z 3003.5 female end	030000007800	Plastic with metal insert	76.0	A-8.0	31.5	6.5	18.5	A+18.0
KA/Z 3003.5 male end	030000007900	Plastic with metal insert	76.0	A-8.0	31.5	6.5	18.5	A+18.0
KA/Z 3004 female end	030000008600	Plastic with metal insert	87.0	A-7.0	31.5	6.5	18.5	A+18.0
KA/Z 3004 male end	030000008700	Plastic with metal insert	87.0	A-7.0	31.5	6.5	18.5	A+18.0
KA/Z 3005 female end	030000008800	Plastic with metal insert	101.0	A-7.0	31.5	6.5	18.5	A+18.0
KA/Z 3005 male end	030000008900	Plastic with metal insert	101.0	A-7.0	31.5	6.5	18.5	A+18.0
KA/Z 3006 female end	030000009300	Plastic with metal insert	125.0	A-6.5	31.5	6.5	18.5	A+18.0
KA/Z 3006 male end	030000009400	Plastic with metal insert	125.0	A-6.5	31.5	6.5	18.5	A+18.0

MP 3000 OPEN

SEPARATOR TR 3000

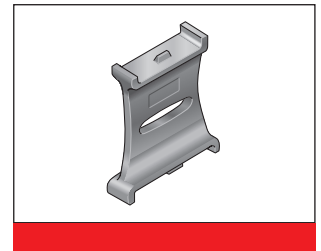
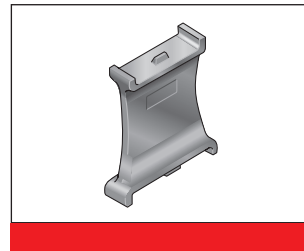
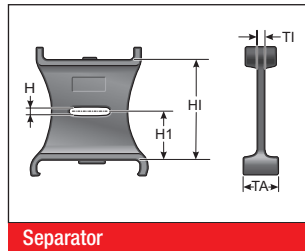
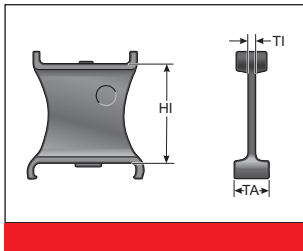

We recommend that separators be used if multiple round cables or conduits with differing diameters are to be installed. For cable

drag chains that need to be side mounted, the lockable (unmovable) separator must be used.

Type	Order No.	Designation	Version	TI mm	TA mm	H mm	H1 mm	H2 mm	HI mm
TR 3000	030000009000	Separator	moveable	1.5	13.0	2.5	12.9	12.9	26.0
TR 3001	030000009200	Separator	lockable	1.5	13.0	2.5	12.9	12.9	26.0
TR 3002	030000009500	Separator, closed	lockable	1.5	13.0				26.0

SHELVING SYSTEM MP 3000

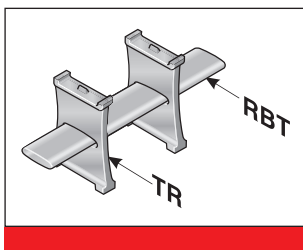

The shelf must be used with a minimum of two separators to create a shelving system. The additional levels prevent cables from criss-crossing and minimise the friction between them. The shelves are matched to the available chain widths.

Type	Order No.	Designation	Width mm	Pitch mm
RBT 037	100000003700	Shelf	37.0	3.03.0
RBT 062	100000006200	Shelf	62.0	3.03.0
RBT 086	100000008600	Shelf	86.0	3.03.0
RBT 101	100000010100	Shelf	101.0	3.03.0
RBT 125	100000012500	Shelf	125.0	3.03.0

RE 26 H-SHAPED SHELF UNIT

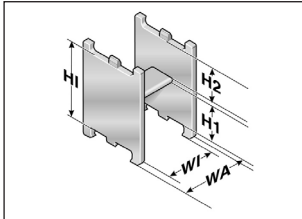

Shelf unit

One-piece shelving system, the shelf cannot be varied in height.

Type	Order No.	Designation	WA mm	WI mm	H1 mm	H2 mm	HI mm
RE 26/15	100000261510	H-shaped shelf unit	17.5	12.5	13.7	9.6	26.0
RE 26/27	100000262710	H-shaped shelf unit	29.5	24.5	13.7	9.6	26.0
RE 26/32	100000263210	H-shaped shelf unit	34.5	29.5	13.7	9.6	26.0
RE 26/51	100000265110	H-shaped shelf unit	53.5	48.5	13.7	9.6	26.0

GUIDE CHANNEL VAW (ALUMINIUM / STAINLESS STEEL)

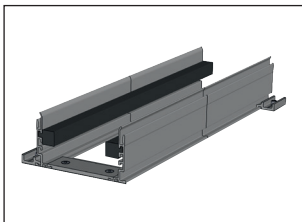

VAW aluminium

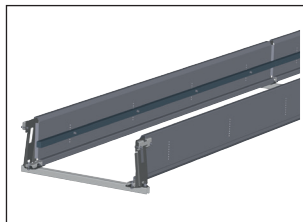

VAW stainless steel

For this cable drag chain, a range of variable guide channel systems are available, constructed from aluminium or stainless steel sections. The variable guide channel ensures that the cable drag chain is supported and guided securely. For help on choosing, please consult the chapter „Variable Guide Channel System“.

ASSEMBLY

DISASSEMBLY

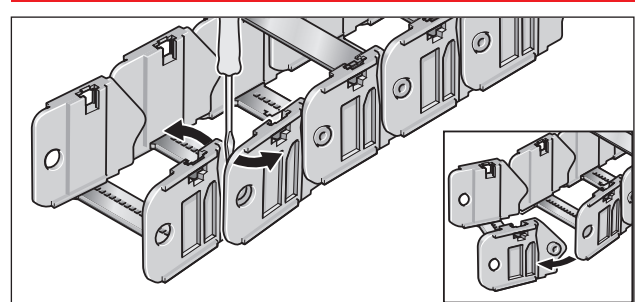
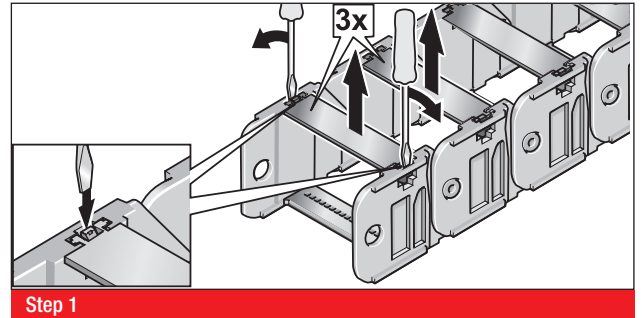
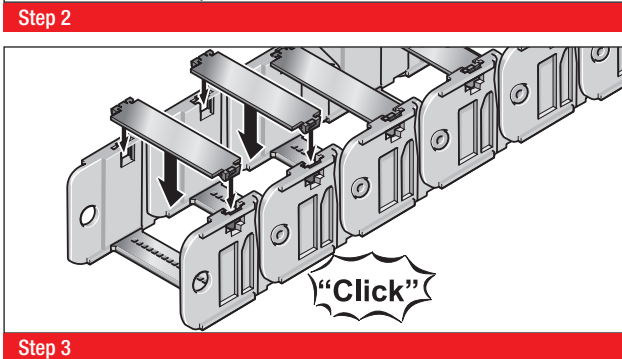
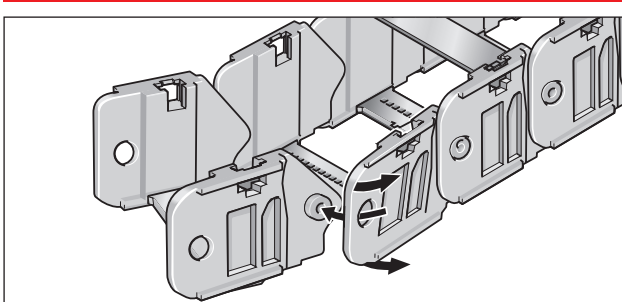
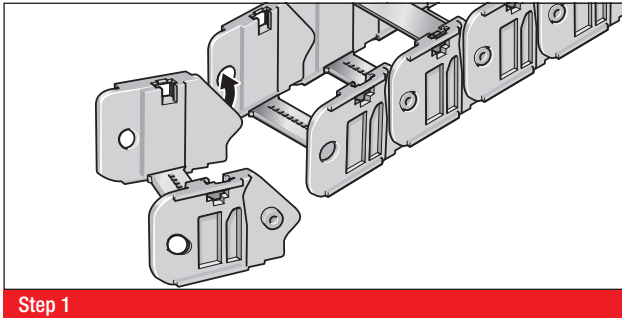

All details given in our sales material prospectuses and catalogues as well as the information available online are based on our current knowledge of the products described.

The electronic data and files made available by Murrplastik, particularly CAD files are based on our current knowledge of the product described.

A legally binding assurance of certain properties or the suitability for a certain purpose can not be determined from this information.

All information with respect to the chemical and physical properties of Murrplastik products as well as application advice given verbally, in writing or by tests, is given to the best of our knowledge.

This does not free the purchaser of carrying out their own inspections and tests in order to determine the suitability of a product for a specific purpose.

Murrplastik accepts no responsibility for the available information being up-to-date, correct or complete. Neither do we accept responsibility for the quality of this information.

Murrplastik accepts no liability for damage caused as a result of using our products.

Murrplastik reserves the right to make technical changes and improvements through constant further development of products and services.

Our General Terms and Conditions apply.