

LC4H Counters

Timers/Time Switches/Counters/Hour Meters



LC4H Counters

**UL File No.: E122222
C-UL File No.: E122222**

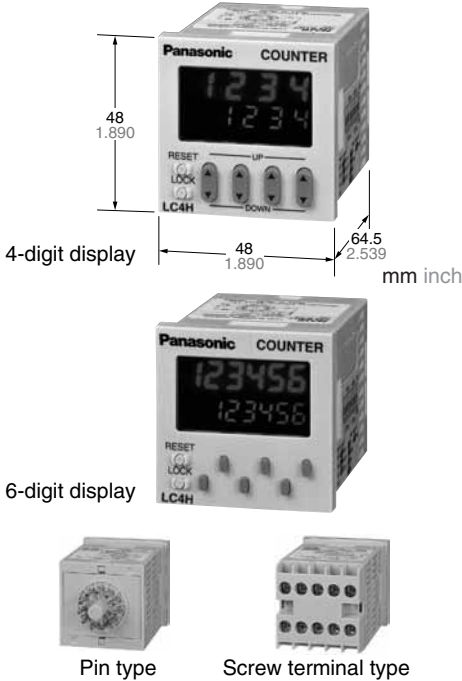

Features

- Bright and Easy-to-Read Display**
A brand new bright 2-color backlight LCD display. The easy-to-read screen in any location makes checking and setting procedures a cinch.
- Simple Operation**
Seesaw buttons make operating the unit even easier than before.
- Short Body of only 64.5 mm 2.539 inch (screw type) or 70.1 mm 2.760 inch (pin type)**
With a short body, it easily installs in even narrow control panels.
- Conforms to IP66's Weather Resistant Standards**
The water-proof panel keeps out water and dirt for reliable operation even in poor environments.

5. Screw terminal and Pin Type are Both Standard Options

The two terminal types are standard options to support either front panel installation or embedded installation.

6. Changeable Panel Cover

Also offers a black panel cover to meet your design considerations.

7. 4-digit or 6-digit display

Two sizes of displays are offered for you to choose the one that suits your needs.

8. Compliant with UL, c-UL and CE.

RoHS Directive compatibility information
<http://www.nais-e.com/>

Product types

Digit	Count speed	Output mode	Output	Operating voltage	Power down insurance	Terminal type	Part number		
4	30 Hz (cps)/ 5 KHz (Kcps) switchable	<ul style="list-style-type: none"> Maintain output/hold count Maintain output/over count I Maintain output/over count II One shot/over count One shot/recount I One shot/recount II One shot/hold count (7 modes) 	Relay (1c)	100 to 240 V AC	Available	8 pins	LC4H-R4-AC240V		
						24 V AC	11 pins	LC4H-R4-AC240V	
						12 to 24 V DC	Screw terminal	LC4H-R4-AC240VS	
				Transistor (1a)			100 to 240 V AC	8 pins	LC4H-R4-AC24V
							24 V AC	11 pins	LC4H-R4-AC24V
							12 to 24 V DC	Screw terminal	LC4H-R4-AC24VS
			Relay (1c)				100 to 240 V AC	8 pins	LC4H-R4-DC24V
							24 V AC	11 pins	LC4H-R4-DC24V
							12 to 24 V DC	Screw terminal	LC4H-R4-DC24VS
				Transistor (1a)			100 to 240 V AC	8 pins	LC4H-T4-AC240V
							24 V AC	11 pins	LC4H-T4-AC240V
							12 to 24 V DC	Screw terminal	LC4H-T4-AC240VS
Relay (1c)		100 to 240 V AC	8 pins		LC4H-T4-AC24V				
		24 V AC	11 pins		LC4H-T4-AC24V				
		12 to 24 V DC	Screw terminal		LC4H-T4-AC24VS				
	Transistor (1a)		100 to 240 V AC	8 pins	LC4H-T4-DC24V				
			24 V AC	11 pins	LC4H-T4-DC24V				
			12 to 24 V DC	Screw terminal	LC4H-T4-DC24VS				
Relay (1c)			100 to 240 V AC	8 pins	LC4H-R6-AC240V				
			24 V AC	11 pins	LC4H-R6-AC240V				
			12 to 24 V DC	Screw terminal	LC4H-R6-AC240VS				
	Transistor (1a)		100 to 240 V AC	8 pins	LC4H-R6-AC24V				
			24 V AC	11 pins	LC4H-R6-AC24V				
			12 to 24 V DC	Screw terminal	LC4H-R6-AC24VS				
Relay (1c)			100 to 240 V AC	8 pins	LC4H-R6-DC24V				
			24 V AC	11 pins	LC4H-R6-DC24V				
			12 to 24 V DC	Screw terminal	LC4H-R6-DC24VS				
	Transistor (1a)		100 to 240 V AC	8 pins	LC4H-T6-AC240V				
			24 V AC	11 pins	LC4H-T6-AC240V				
			12 to 24 V DC	Screw terminal	LC4H-T6-AC240VS				
Relay (1c)			100 to 240 V AC	8 pins	LC4H-T6-AC24V				
			24 V AC	11 pins	LC4H-T6-AC24V				
			12 to 24 V DC	Screw terminal	LC4H-T6-AC24VS				
	Transistor (1a)		100 to 240 V AC	8 pins	LC4H-T6-DC24V				
			24 V AC	11 pins	LC4H-T6-DC24V				
			12 to 24 V DC	Screw terminal	LC4H-T6-DC24VS				

* A rubber gasket (ATC18002) and a mounting frame (AT8-DA4) are included.

LC4H-L Counters

UL File No.: E122222
C-UL File No.: E122222

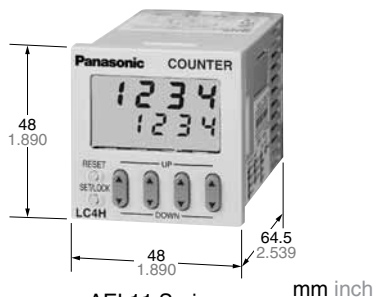

AEL11 Series
(4-digit display)



AEL13 Series
(6-digit display)



Pin type



Screw terminal type

Features

- 1. Low Price**
All this at an affordable price to provide you with unmatched cost performance.
- 2. Display is a bright reflective-type LCD.**
- 3. Inherits all of the characteristics of the LC4H digital timer.**
 - Seesaw switches ensure easy operation.
 - IP66 environmental protection.
 - Shortened body (pin type: 70.1 mm 2.760 inch, screw type: 64.5 mm 2.539 inch underhead).
- 4. Compliant with UL, c-UL and CE.**

Product types

Digit	Count speed	Output mode	Output	Operating voltage	Power down insurance	Terminal type	Part number
4	30 Hz (cps)/ 5 KHz (Kcps) switchable	<ul style="list-style-type: none"> • Maintain output/hold count • Maintain output/over count I • Maintain output/over count II • One shot/over count • One shot/recount I • One shot/recount II • One shot/hold count (7 modes) 	Relay (1c)	100 to 240 V AC	Available	8 pins	LC4HL8-R4-AC240V
				24 V AC/DC		11 pins	LC4HL-R4-AC240V
				12 to 24 V DC		Screw terminal	LC4HL-R4-AC240VS
			6	Relay (1c)		8 pins	LC4HL8-R4-AC24V
						11 pins	LC4HL-R4-AC24V
						Screw terminal	LC4HL-R4-AC24VS
8 pins						LC4HL8-R4-DC24V	
11 pins						LC4HL-R4-DC24V	
Screw terminal						LC4HL-R4-DC24VS	
6			Transistor (1a)	8 pins		LC4HL8-T4-AC240V	
				11 pins		LC4HL-T4-AC240V	
				Screw terminal		LC4HL-T4-AC240VS	
	8 pins	LC4HL8-T4-AC24V					
	11 pins	LC4HL-T4-AC24V					
	Screw terminal	LC4HL-T4-AC24VS					
6	Relay (1c)	8 pins	LC4HL8-R6-AC240V				
		11 pins	LC4HL-R6-AC240V				
		Screw terminal	LC4HL-R6-AC240VS				
		8 pins	LC4HL8-R6-AC24V				
		11 pins	LC4HL-R6-AC24V				
		Screw terminal	LC4HL-R6-AC24VS				
6	Transistor (1a)	8 pins	LC4HL8-R6-DC24V				
		11 pins	LC4HL-R6-DC24V				
		Screw terminal	LC4HL-R6-DC24VS				
		8 pins	LC4HL8-T6-AC240V				
		11 pins	LC4HL-T6-AC240V				
		Screw terminal	LC4HL-T6-AC240VS				
6	Relay (1c)	8 pins	LC4HL8-T6-AC24V				
		11 pins	LC4HL-T6-AC24V				
		Screw terminal	LC4HL-T6-AC24VS				
		8 pins	LC4HL8-T6-DC24V				
		11 pins	LC4HL-T6-DC24V				
		Screw terminal	LC4HL-T6-DC24VS				

* A rubber gasket (ATC18002) and a mounting frame (AT8-DA4) are included.

Part names

• 4-digit display type

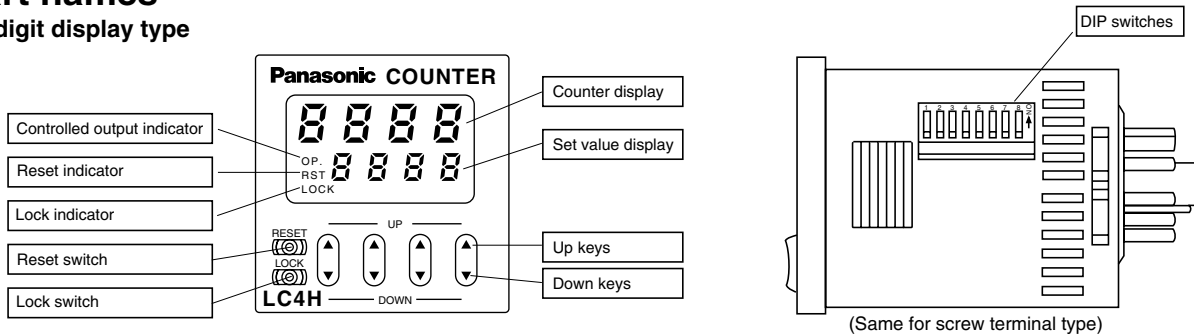

• 6-digit display type

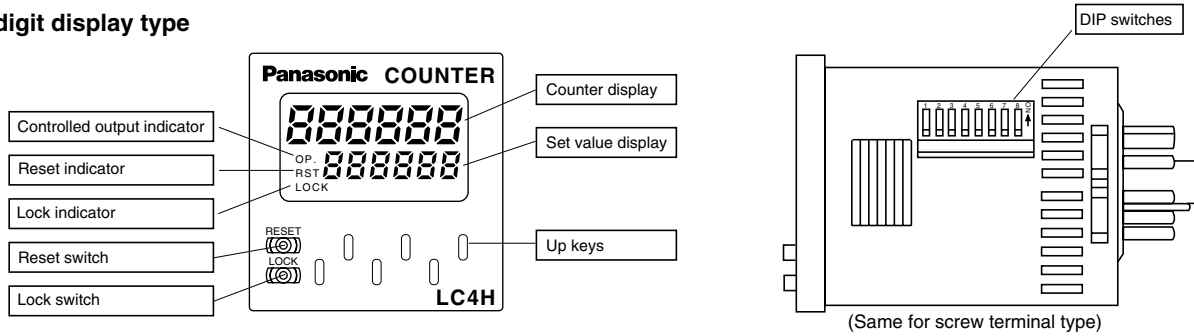

Specifications

Item		Relay output type		Transistor output type	
		AC type	DC type	AC type	DC type
Rating	Rated operating voltage	100 to 240 V AC, 24 V AC	12 to 24 V DC	100 to 240 V AC, 24 V AC	12 to 24 V DC
	Rated frequency	50/60 Hz common		50/60 Hz common	
	Rated power consumption	Max. 10 V A	Max. 3 W	Max. 10 V A	Max. 3 W
	Rated control capacity	5 A 250 V AC (resistive load)		100 mA 30 V DC	
	Input mode	Addition (UP)/Subtraction (DOWN)/Direction (DIR)/Individuality (IND)/Phase (PHASE) 5 modes selectable by DIP switch			
	Max. counting speed	30 Hz/5 kHz (selectable by DIP switch)			
	Counting input (Input 1, 2)	Min. input signal width: 16.7 ms at 30 Hz/0.1 ms at 5 kHz, ON time: OFF time = 1:1			
	Reset input	Min. input signal width: 1 ms, 20 ms (selected by DIP switch)			
	Lock input	Min. input signal width: 20 ms			
	Input signal	Contact or Open collector input/Input impedance: 1 kΩ or less, Input residual voltage: 2 V or less, Open impedance: 100 kΩ or more, Max. energized voltage: 40 V DC			
	Output mode	HOLD-A/HOLD-B/HOLD-C/SHOT-A/SHOT-B/SHOT-C/SHOT-D (7 modes selectable by DIP switch)			
	One shot output time	Approx. 1 s			
	Indication	7-segment LCD, Counter value (backlight red LED), Setting value (backlight yellow LED)			
Digit		4-digit display type -999 to 9999 (-3 digits to +4 digits) (0 to 9999 for setting) 6-digit display type -99999 to 999999 (-5 digits to 6 digits) (0 to 999999 for setting)			
Memory		EEP-ROM (Overwriting times: 10 ⁵ ope. or more)			
Contact	Contact arrangement	1 Form C		1 Form A (Open collector)	
	Initial contact resistance	100 mΩ (at 1 A 6 V DC)		—	
	Contact material	Ag alloy/Au flush		—	
Life	Mechanical (contact)	2 × 10 ⁷ ope. (Except for switch operation parts)		—	
	Electrical (contact)	10 ⁵ ope. (At rated control voltage)		10 ⁷ ope. (At rated control voltage)	
Electrical	Allowable operating voltage range	85 to 110 % of rated operating voltage			
	Break down voltage (Initial value)	Between live and dead metal parts: 2,000 Vrms for 1 min (11-pin type) Between input and output: 2,000 Vrms for 1 min Between open contacts: 1,000 Vrms for 1 min		Between live and dead metal parts: 2,000 Vrms for 1 min (11-pin type) Between input and output: 2,000 V AC for 1 min	
	Insulation resistance (At 500 V DC) (Initial value)	Between live and dead metal parts: Min. 100 MΩ (11-pin type) Between input and output: Min. 100 MΩ Between open contact: Min. 100 MΩ		Between live and dead metal parts: Min. 100 MΩ (11-pin type) Between input and output: Min. 100 MΩ	
	Temperature rise	Max. 65° C (under the flow of nominal operating current at nominal voltage)			
Mechanical	Vibration resistance	Functional	10 to 55 Hz (1 cycle/min), single amplitude: 0.35 mm (10 min on 3 axes)		
		Destructive	10 to 55 Hz (1 cycle/min), single amplitude: 0.75 mm (1 h on 3 axes)		
	Shock resistance	Functional	Min. 98 m 321.522 ft./s ² (4 times on 3 axes)		
		Destructive	Min. 294 m 964.567 ft./s ² (5 times on 3 axes)		
Operating conditions	Ambient temperature	-10° C to 55° C +14° F to +131° F			
	Ambient humidity	Max. 85 % RH (non-condensing)			
	Air pressure	860 to 1,060 h Pa			
	Ripple rate	—	20 % or less	—	20 % or less
Connection	8-pin/11-pin/screw terminal				
Protective construction	IP66 (front panel with a rubber gasket)				

LC4H/-L

Applicable standard

Safety standard	EN61812-1	Pollution Degree 2/Overvoltage Category II
EMC	(EMI)EN61000-6-4 Radiation interference electric field strength Noise terminal voltage (EMS)EN61000-6-2 Static discharge immunity	EN55011 Group1 ClassA EN55011 Group1 ClassA
	RF electromagnetic field immunity EFT/B immunity Surge immunity Conductivity noise immunity Power frequency magnetic field immunity Voltage dip/Instantaneous stop/Voltage fluctuation immunity	EN61000-4-2 4 kV contact 8 kV air EN61000-4-3 10 V/m AM modulation (80 MHz to 1 GHz) 10 V/m pulse modulation (895 MHz to 905 MHz) EN61000-4-4 2 kV (power supply line) 1 kV (signal line) EN61000-4-5 1 kV (power line) EN61000-4-6 10 V/m AM modulation (0.15 MHz to 80 MHz) EN61000-4-8 30 A/m (50 Hz) EN61000-4-11 10 ms, 30% (rated voltage) 100 ms, 60% (rated voltage) 1,000 ms, 60% (rated voltage) 5,000 ms, 95% (rated voltage)

Dimensions

mm inch

General tolerance: ± 1.0 ± 0.039

• 4-digit display type

Screw terminal type: M3.5
(Flush mount)

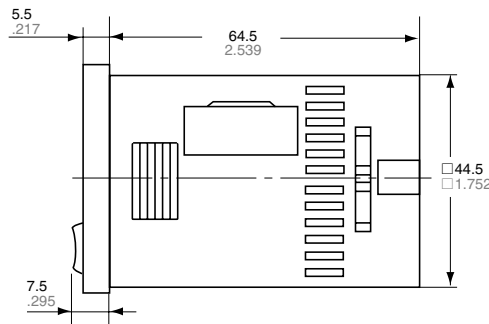
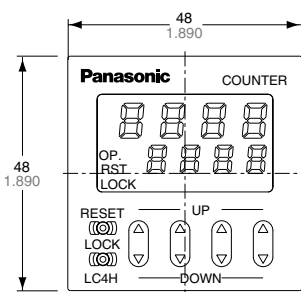

Pin type
(Flush mount/Surface mount)

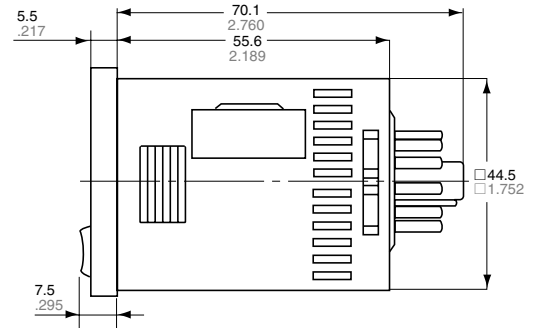

• 6-digit display type

Screw terminal type: M3.5
(Flush mount)

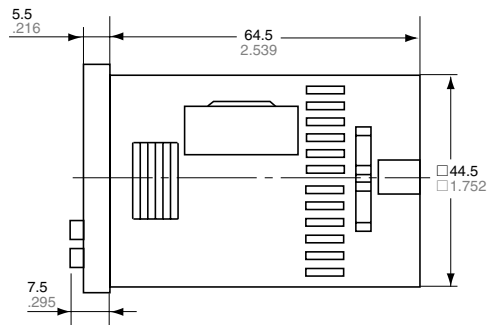
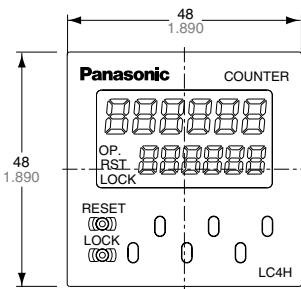

Pin type
(Flush mount/Surface mount)

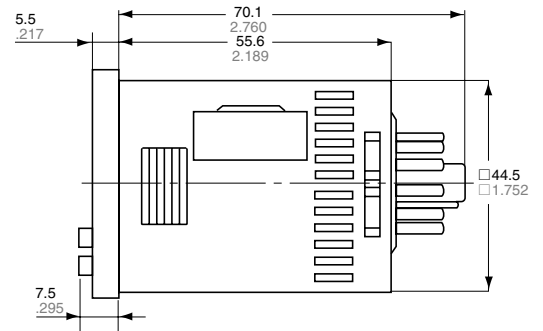

• Dimensions for flush mounting (with adapter installed)

Screw terminal type: M3.5

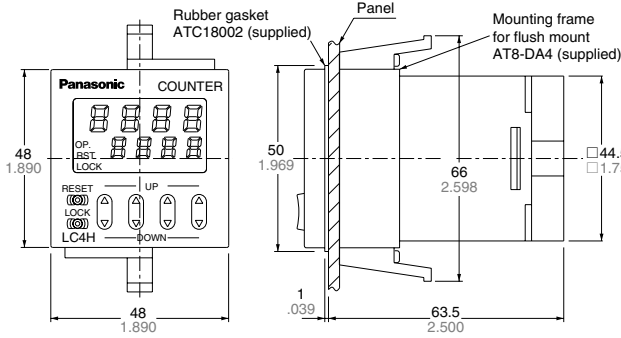

Pin type

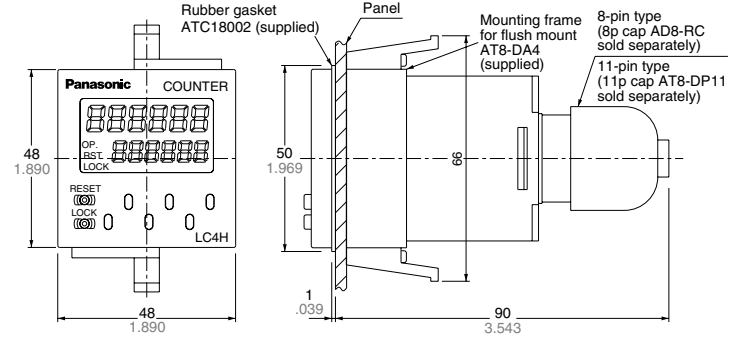

• Dimensions for front panel installations

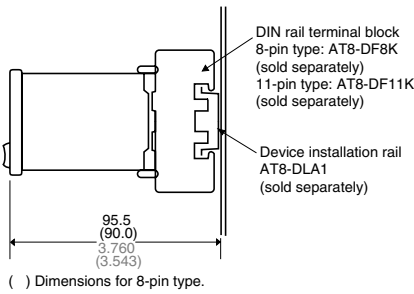

• Installation panel cut-out dimensions

The standard panel cut-out dimensions are shown below. Use the mounting frame (AT8-DA4) and rubber gasket (ATC18002).

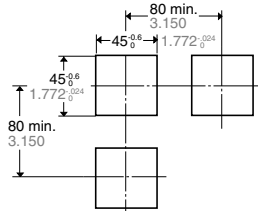

• For connected installations

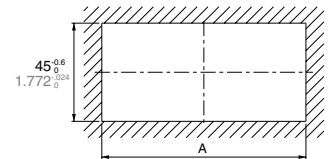

$$A = (48 \times n - 2.5) \text{ } ^{-0.6}$$

Note 1: The installation panel thickness should be between 1 and 5 mm .039 and .197 inch.

Note 2: For connected installations, the waterproofing ability between the unit and installation panel is lost.

Terminal layouts and Wiring diagrams

• 8-pin type

Relay output type

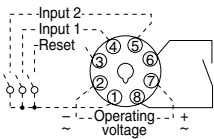

Transistor output type

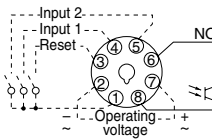

• 11-pin type

Relay output type

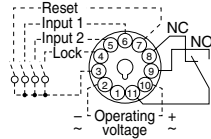

Transistor output type

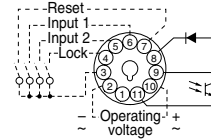

• Screw terminal type

Relay output type

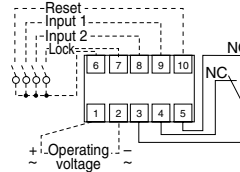

Transistor output type

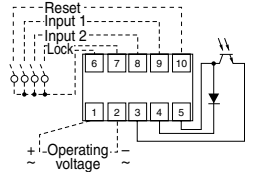

Note) For connecting the output leads of the transistor output type, refer to 5) Transistor output on page 141.

Setting the operation mode and set value

Setting procedure 1) Setting the operation mode (input mode and output mode)

Set the input and output modes with the DIP switches on the side of the counter.

DIP switches

	Item	DIP switch	
		OFF	ON
1	Output mode	Refer to table 1	
2			
3			
4	Minimum reset input signal width	20 ms	1 ms
5	Maximum counter speed	30 Hz	5 kHz
6	Input mode	Refer to table 2	
7			
8			

Table 1: Setting the output mode

DIP switch No.			Output mode
1	2	3	
ON	ON	ON	SHOT-A
OFF	OFF	OFF	SHOT-B
ON	OFF	OFF	SHOT-C
OFF	ON	OFF	SHOT-D
ON	ON	OFF	HOLD-A
OFF	OFF	ON	HOLD-B
ON	OFF	ON	HOLD-C
OFF	ON	ON	— (See note 1)

Table 2: Setting the input mode

DIP switch No.			Input mode
6	7	8	
ON	ON	ON	Addition input
OFF	OFF	OFF	Subtraction input
ON	OFF	OFF	Directive input
OFF	ON	OFF	Independent input
ON	ON	OFF	Phase input
OFF	OFF	ON	— (See note 1)
ON	OFF	ON	— (See note 1)
OFF	ON	ON	— (See note 1)

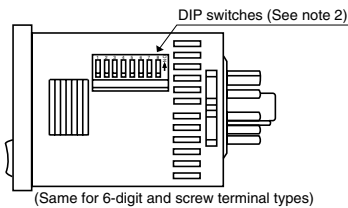

- Notes: 1) The counter and set value displays will display DIP Err.
 2) Set the DIP switches before installing the counter on the panel.
 3) When the DIP SW setting is changed, turn off the power once.
 4) The DIP switches are set as ON before shipping.

Setting procedure 2) Setting the set value

Set the set value with the UP and DOWN keys on the front of the counter.

Front display section

• 4-digit display type

- ① Counter display
 - ② Set value display
 - ③ Controlled output indicator
 - ④ Reset indicator
 - ⑤ Lock indicator
 - ⑥ UP keys
- Changes the corresponding digit of the set value in the addition direction (upwards).

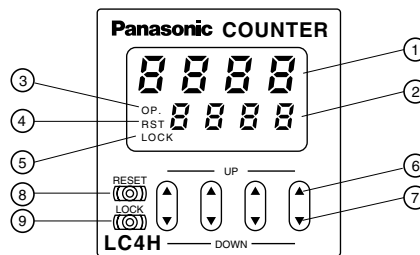

• 6-digit display type

- ① Counter display
- ② Set value display
- ③ Controlled output indicator
- ④ Reset indicator
- ⑤ Lock indicator

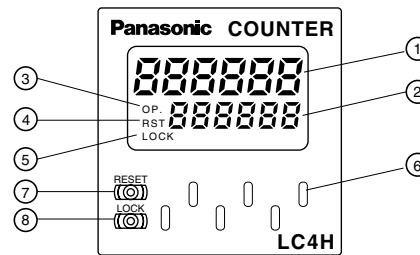

• Changing the set value

1. It is possible to change the set value with the up and down keys (4-digit type only) even during counting. However, be aware of the following points.

1) If the set value is changed to less than the count value with counting set to the addition direction, counting will continue until it reaches full scale (9999 with the 4-digit type and 999999 with the 6-digit type), returns to zero, and then reaches the new set value. If the set value is changed to a value above the count value, counting will continue until the count value reaches the new set value.

2) Suppose that the counter is preset to count down. Whether a preset count-down value is smaller or larger than the count value, the counter counts down to "0(Zero)".

2. If the set value is changed to "0," the unit will not complete count-up. It starts counting up when the counting value comes to "0 (Zero)" again.

1) Up-count (addition) input when counting is set to the addition direction, counting will continue until full scale is reached (9999 with the 4-digit type and 999999 with the 6-digit type), return to zero, and then complete count-up.

- ⑦ DOWN keys
- Changes the corresponding digit of the set value in the subtraction direction (downwards).
- ⑧ RESET switch
- Resets the counting value and the output.
- ⑨ LOCK switch
- Locks the operation of all keys on the counter.
- ⑥ UP keys
- Changes the corresponding digit of the set value in the addition direction (upwards).
- ⑦ RESET switch
- Resets the counting value and the output.
- ⑧ LOCK switch
- Locks the operation of all keys on the counter.

2) Down-count (subtraction) input when counting is set to the subtraction direction, counting will continue until full scale is reached (-999 with the 4-digit type and -999999 with the 6-digit type), and then the display will change to - - - - with the 4-digit type and - - - - - with the 6-digit type. The counting value does not become "0" and so the counter does not count up.

3) For directive, independent, and phase input, when the counting value increases or decreases from the value "0" and then returns back to the value "0," count-up is completed.

2. Output mode

For the output mode, you can choose one of the following seven modes

- Maintain output/hold count HOLD-A
- Maintain output/over count I HOLD-B
- Maintain output/over count II HOLD-C
- One shot/over count SHOT-A
- One shot/recount I SHOT-B
- One shot/recount II SHOT-C
- One shot/hold count SHOT-D

Output mode	Operation	(Example when input mode is either addition or subtraction)
Maintain output Hold count HOLD-A	Output control is maintained after count-up completion and until resetting. During that time, the count display does not change from that at count-up completion.	<p>* n: Set value</p>
Maintain output Over count I HOLD-B	Output control is maintained after count-up completion and until resetting. However, counting is possible despite completion of count-up.	<p>* n: Set value</p>
Maintain output Over count II HOLD-C	Output control is maintained after count-up completion and until the next signal enters. However, counting is possible despite completion of count-up.	<p>* n: Set value</p>
One shot Over count SHOT-A	Output control is maintained after count-up completion for a fixed time (approx. 1 sec). Counting is possible despite completion of count-up.	<p>* n: Set value</p>
One shot Recount I SHOT-B	Output control is maintained after count-up completion for a fixed time (approx. 1 sec). Counting is possible despite completion of count-up. However, reset occurs simultaneous with completion of count-up. While output is being maintained, restarting of the count is not possible	<p>* n: Set value</p>
One shot Recount II SHOT-C	Output control is maintained after count-up completion for a fixed time (approx. 1 sec). Counting is possible despite completion of count-up. However, reset occurs simultaneous with output OFF.	<p>* n: Set value</p>
One shot Hold count SHOT-D	Output control is maintained after count-up completion for a fixed time (approx. 1 sec). During that time, the count display does not change from that at count-up completion. Reset occurs simultaneous with output OFF.	<p>* n: Set value</p>



4-digit type



6-digit type



11 pin type



Screw terminal type

RoHS Directive compatibility information
<http://www.nais-e.com/>

UL File No.: E122222
C-UL File No.: E122222



Features

- Bright and Easy-to-Read Display**
A brand new bright 2-color backlight LCD display. The easy-to-read screen in any location makes checking and setting procedures a cinch.
- Easy to use, simple operation, simple settings**
 - Operation modes (input/output modes) can be set easily, using DIP switches on the side panel.
 - Values can be set easily, using key switches on the front panel.
- Pre-scaling function provided**
A pre-scaling function enables conversion of lengths and volumes to any desired values, and displays the results.
- Built-in power supply for high-capacitance sensor**
An internal power supply drives a 12 VDC, 100 mA high-capacitance sensor. (AC power supply types only)
Photoelectric switches, proximity switches and encoders can be directly connected.
- Dual-path AC sensor can be connected.**

- Basic insulation between the power supply and the input terminal (only for the sensor type model with power supply)**

There is no need for caution when connecting between terminals.

- Conforms to IP66's Weather Resistant Standards**

The water-proof panel keeps out water and dirt for reliable operation even in poor environments.

- 4-digit or 6-digit display**

Two sizes of displays are offered for you to choose the one that suits your needs.

- Screw terminal and Pin Type are Both Standard Options**

The two terminal types are standard options to support either front panel installation or embedded installation.

- Compliant with UL, c-UL and CE.**
- Low Price**

All this at an affordable price to provide you with unmatched cost performance.

Product types

Digit	Count speed	Operation mode	Output	Operation voltage	Power for sensor	Terminal	Part No.
4	30 Hz/5 KHz switchable	<ul style="list-style-type: none"> • Maintain output/hold count • Maintain output/over count I • Maintain output/over count II • One shot/over count • One shot/recount I • One shot/recount II • One shot/hold count (7 modes) 	Relay	100 to 240 V AC	12 V DC 100mA	11 pins	LC4H-PS-R4-AC240V
				12 to 24 V DC /24 V AC	None	Screw terminal	LC4H-PS-R4-AC240VS
			Transistor	12 to 24 V DC /24 V AC	None	11 pins	LC4H-S-R4-24V
				12 to 24 V DC /24 V AC	None	Screw terminal	LC4H-S-R4-24VS
6	30 Hz/5 KHz switchable	<ul style="list-style-type: none"> • Maintain output/hold count • Maintain output/over count I • Maintain output/over count II • One shot/over count • One shot/recount I • One shot/recount II • One shot/hold count (7 modes) 	Relay	100 to 24 V AC	12 V DC 100mA	11 pins	LC4H-PS-R6-AC240V
				12 to 24 V DC /24 V AC	None	Screw terminal	LC4H-PS-R6-AC240VS
			Transistor	12 to 24 V DC /24 V AC	None	11 pins	LC4H-S-R6-24V
				12 to 24 V DC /24 V AC	None	Screw terminal	LC4H-S-R6-24VS

Notes) 1. Rubber packing (ATC18002) and an mounting frame (AT8-DA4) are included.
2. 100 to 240 VAC Tr outputs (11-pin terminal, screw-tightening terminal) types are also supported.

LC4H-S

Part names

• 4-digit display type

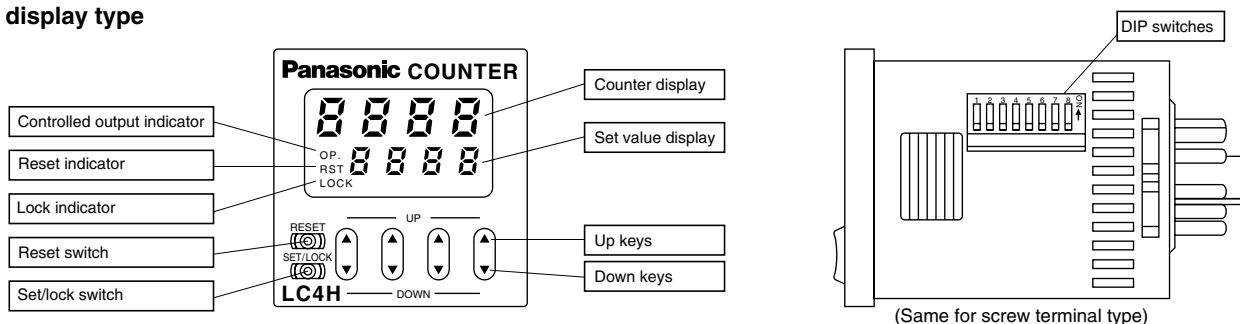

(Same for screw terminal type)

• 6-digit display type

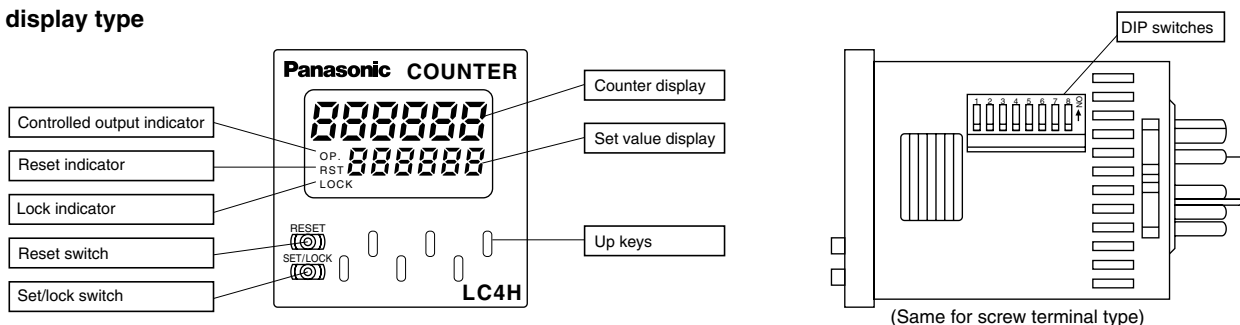

(Same for screw terminal type)

Specifications

Item		Relay output type		Transistor output type
		AC type	DC/AC type	DC/AC type
Rating	Rated operating voltage	100 to 240 V	12 to 24 V DC/24 V AC	12 to 24 V DC/24 V AC
	Rated frequency	50/60 Hz common		
	Rated power consumption	Max. 10 V A	Max. 3 W	
	Rated control capacity	5 A 250 V AC (resistive load)		100 mA, 30 V DC
	Input mode	Addition (UP)/Subtraction (DOWN)/Direction (DIR)/Individuality (IND)/Phase (PHASE) 5 modes selectable by DIP switches		
	Max. counting speed	30 Hz, 5 kHz (selectable by DIP switches)		
	Counting input (input 1, input 2)	16.7 ms at 30 Hz/0.1 ms at 5 kHz ON time: OFF time = 1:1		
	Reset input	Min. input signal width: 1 ms, 20 ms (selected by DIP switches)		
	Lock input	Min. input signal width: 20 ms		
	Input signal	Contact, Open collector input/DC two-wire system sensor Input impedance: 1 kΩ or less, Input residual voltage: 2 V or less, Open impedance: 100 kΩ or less, Max. energized voltage: 40 V DC		
	Output mode	HOLD-A, HOLD-B, HOLD-C, SHOT-A, SHOT-B, SHOT-C, SHOT-D, 7 modes selectable by DIP switches		
	One shot output time	1 s, 0.5s, 0.2s, 0.1s, 0.05, 0.01s		
	Indication	7-segment LCD, Counter value (backlight red LED), Setting value (backlight yellow LED)		
	Digit	4-digit display type -999 to 9999 (0 to 9999 for setting) 6-digit display type -99999 to 999999 (0 to 999999 for setting)		
	Decimal point	Can be set to three digits		
	Pre-scaling	0.001 to 9.999 (4-digit type), 0.001 to 99.999 (6-digit type)		
	Memory	EEP-ROM (Overwriting times: 10 ⁵ ope. or more)		
Power for sensor	12 V DC (±10%) 100 mA Max.	—		
Contact	Contact arrangement	1 Form C		1 Form A (Open collector)
	Initial contact resistance	100 mΩ (at 1 A 6 V DC)		—
	Contact material	Ag alloy/Au flush		—
Life	Mechanical (contact)	2 × 10 ⁷ ope. (Except for switch operation parts)		—
	Electrical (contact)	10 ⁵ ope. (At rated control voltage)		10 ⁷ ope. (At rated control voltage)
Electrical	Operating voltage range	85 to 264 V AC	10.8 to 26.4 V DC, 20.4 to 26.4 V AC	
	Initial withstand voltage	Between live and dead metal parts: 2,000 Vrms for 1 min (pin type) Between input and output: 2,000 Vrms for 1 min		
	Initial insulation resistance (At 500 V DC)	Between live and dead metal parts: Min. 100 MΩ (pin type) Between input and output: Min. 100 MΩ		
	Temperature rise	Max. 65° C (under the flow of nominal operating current at nominal voltage)		
Mechanical	Vibration resistance	Functional	10 to 55 Hz (1 cycle/min), single amplitude: 0.35 mm (10 min on 3 axes)	
		Destructive	10 to 55 Hz (1 cycle/min), single amplitude: 0.75 mm (1 h on 3 axes)	
	Shock resistance	Functional	Min. 98 m/s ² (4 times on 3 axes)	
		Destructive	Min. 294 m/s ² (5 times on 3 axes)	
Operating conditions	Ambient temperature	-10° C to 55° C +14° F to +131° F		
	Ambient humidity	Max. 85 % RH (non-condensing)		
	Air pressure	860 to 1,060 h Pa		
Connection	11-pin/screw terminal			
Protective construction	IP66 (front panel with a rubber gasket)			

Terminal layouts and Wiring diagrams

• Pin type

* With power supply for sensor

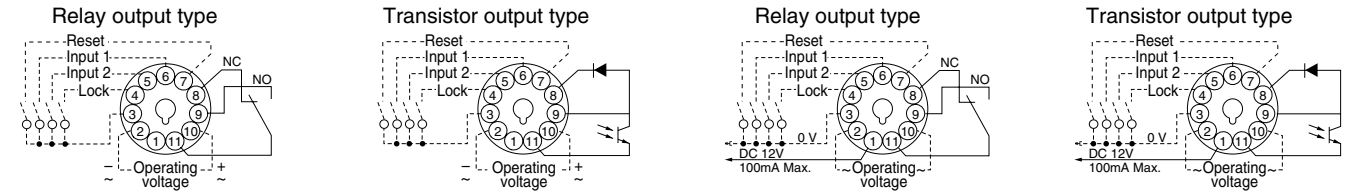

• Screw terminal type

* With power supply for sensor

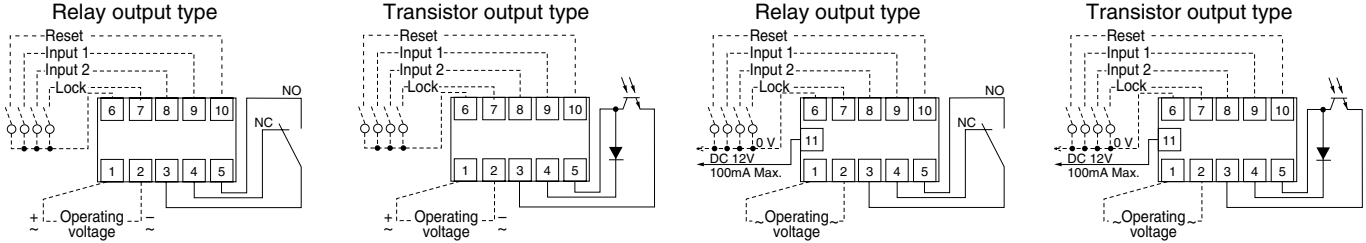

Note) For connecting the output leads of the transistor output type, refer to 5) Transistor output on page 141.

Setting the operation mode and counter

Setting procedure 1) Setting the operation mode (input mode and output mode)

Set the input and output modes with the DIP switches on the side of the counter.

DIP switches

Item	DIP switch		
	OFF	ON	
1	Refer to table 1		
2			
3			
4	Minimum reset input signal width	20 ms	1 ms
5	Maximum counter setting	30 Hz	5 kHz
6	Refer to table 2		
7			
8			

Table 1: Setting the output mode

DIP switch No.			Output mode
1	2	3	
ON	ON	ON	SHOT-A
OFF	OFF	OFF	SHOT-B
ON	OFF	OFF	SHOT-C
OFF	ON	OFF	SHOT-D
ON	ON	OFF	HOLD-A
OFF	OFF	ON	HOLD-B
ON	OFF	ON	HOLD-C
OFF	ON	ON	— (See note 1)

Table 2: Setting the input mode

DIP switch No.			Input mode
6	7	8	
ON	ON	ON	Addition input
OFF	OFF	OFF	Subtraction input
ON	OFF	OFF	Directive input
OFF	ON	OFF	Independent input
ON	ON	OFF	Phase input
OFF	OFF	ON	— (See note 1)
ON	OFF	ON	— (See note 1)
OFF	ON	ON	— (See note 1)

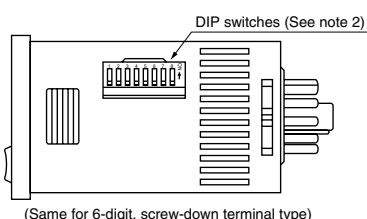

- Notes: 1) The counter and set value displays will display DIP Err.
 2) Set the DIP switches before installing the counter on the panel.
 3) When the DIP SW setting is changed, turn off the power once.
 4) The DIP switches are set as ON before shipping.

Setting procedure 2) Setting the set value

Set the set value with the UP and DOWN keys on the front of the counter.

Front display section

• 4-digit display type

- ① Counter display
 - ② Set value display
 - ③ Controlled output indicator
 - ④ Reset indicator
 - ⑤ Lock indicator
 - ⑥ UP keys
- Changes the corresponding digit of the set value in the addition direction (upwards)

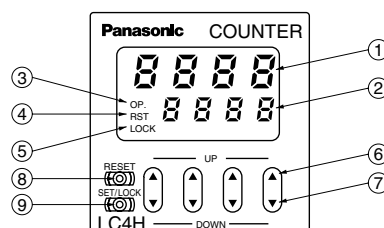

- ⑦ DOWN keys
- Changes the corresponding digit of the set value in the subtraction direction (downwards)
- ⑧ RESET switch
 - ⑨ SET/LOCK switch
- This is used to handle pre-scaling values, one-shot times, decimal point position settings, and key lock operations (to disable Up key, Down key, and Reset key operations).

• 6-digit display type

- ① Counter display
- ② Set value display
- ③ Controlled output indicator
- ④ Reset indicator
- ⑤ Lock indicator

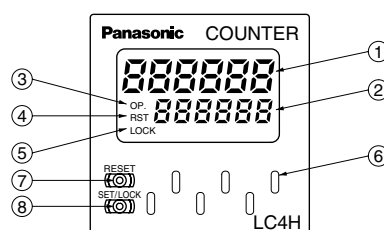

- ⑥ UP keys
- Changes the corresponding digit of the set value in the addition direction (upwards)
- ⑦ RESET switch
 - ⑧ SET/LOCK switch
- This is used to handle pre-scaling values, one-shot times, decimal point position settings, and key lock operations (to disable Up key, Down key, and Reset key operations).

Setting procedure 3) Setting the input mode

The input mode is set using the key switch in the [Display] section on the front of the counter.

• Decimal point position setting mode

- ① Holding down the [SET/LOCK] key, press the key for the second digit to access the decimal point position setting mode.

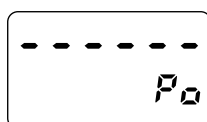

Example) 6-digit type
 Decimal point position setting mode display
 (Example shows default value displayed)

- ② When the setting mode has been accessed, release the [SET/LOCK] key.

- ③ The decimal point is set using the [UP] and [DOWN] keys to specify the 2nd, 3rd, and 4th digits (this applies only to 4-digit models). (The 1st digit is set using the [UP] key or [DOWN] key in settings where there is no decimal point (this applies only to 4-digit models).)

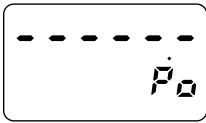

Example) 6-digit type
Example shows 2nd digit displayed using [UP] key

- ④ Press the [RESET] key to set the displayed decimal point position and return to normal operation.

• Setting the pre-scaling value

- ① Holding down the [SET/LOCK] key, press the key for the first digit to access the pre-scaling value setting mode.

Example) 4-digit type



Example) 6-digit type



Pre-scaling value setting mode displayed
(Example shows default values displayed)

- ② When the setting mode has been accessed, release the [SET/LOCK] key.
③ Use the [UP] or [DOWN] key to set the pre-scaling value (this applies only to 4-digit models).
Select either: 0.001 to 9.999 (4-digit) or 0.001 to 99.999 (6-digit)
④ Press the [RESET] key to set the displayed pre-scaling value and return to normal operation.

• Setting the one-shot output time

- ① Holding down the [SET/LOCK] key, press the key for the third digit to access the one-shot output time setting mode.

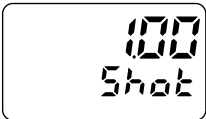

Example) 6-digit type
One-shot output time setting mode displayed
(Example shows default value displayed)

- ② When the setting mode has been accessed, release the [SET/LOCK] key.
③ Each time the 1st-digit [UP] key is pressed, the one-shot output time changes in the following sequence, moving to the right:

→ 1 s → 0.5 s → 0.2 s → 0.1 s → 0.05 s → 0.01 s →

(With a 4-digit type, the [DOWN] key can also be used to move to the left.)

- ④ Press the [RESET] key to set the displayed one-shot output time and return to normal operation.

Changing the set value

1. It is possible to change the set value with the up and down keys (4-digit type only) even during counting. However, be aware of the following points.

1) If the set value is changed to less than the count value with counting set to the addition direction, counting will continue until it reaches full scale (9999 with the 4-digit type and 999999 with the 6-digit type), returns to zero, and then reaches the new set value. If the set value is changed to a value above the count value, counting will continue until the count value reaches the new set value.

2) Suppose that the counter is preset to count down. Whether a preset count-down value is smaller or larger than the count value, the counter counts down to "0 (zero)".

2. If the set value is changed to "0," the unit will not complete count-up. It starts counting up when the counting value comes to "0 (zero)" again.

1) Up-count (addition) input
When counting is set to the addition direction, counting will continue until full scale is reached (9999 with the 4-digit type and 999999 with the 6-digit type), return to zero, and then complete count-up.

2) Down-count (subtraction) input
When counting is set to the subtraction direction, counting will continue until full scale is reached (-999 with the 4-digit type and -99999 with the 6-digit type), and then the display will change to - - - - with the 4-digit type and - - - - - with the 6-digit type.

The counting value does not become "0 (zero)" and so the counter does not count up.

3) Directive, independent, and phase inputs
The counting value is counted up or down to any number other than "0" once. When it comes to "0 (zero)" again, the counter starts counting up.

CAUTIONS FOR USE

For more information regarding the cautions for use of LC4H series counter, refer to page 140 "PRECAUTIONS IN USING THE LC4H SERIES".

LC4H-S

2. Output mode

For the output mode, you can choose one of the following seven modes

- Maintain output/hold count HOLD-A
- Maintain output/over count I HOLD-B
- Maintain output/over count II HOLD-C
- One shot/over count SHOT-A
- One shot/recount I SHOT-B
- One shot/recount II SHOT-C
- One shot/hold count SHOT-D

Output mode	Operation	(Example when input mode is either addition or subtraction)
Maintain output Hold count HOLD-A	Output control is maintained after count-up completion and until resetting. During that time, the count display does not change from that at count-up completion.	<p>* n: Set value</p>
Maintain output Over count I HOLD-B	Output control is maintained after count-up completion and until resetting. However, counting is possible despite completion of count-up.	<p>* n: Set value</p>
Maintain output Over count II HOLD-C	Output control is maintained after count-up completion and until the next signal enters. However, counting is possible despite completion of count-up.	<p>* n: Set value</p>
One shot Over count SHOT-A	Output control is maintained after count-up completion for one shot output time. Counting is possible despite completion of count-up.	<p>* n: Set value</p>
One shot Recount I SHOT-B	Output control is maintained after count-up completion for one shot output time. Counting is possible despite completion of count-up. However, reset occurs simultaneous with completion of count-up. While output is being maintained, restarting of the count is not possible.	<p>* n: Set value</p>
One shot Recount II SHOT-C	Output control is maintained after count-up completion for one shot output time. Counting is possible despite completion of count-up. However, reset occurs simultaneous with output OFF.	<p>* n: Set value</p>
One shot Hold count SHOT-D	Output control is maintained after count-up completion for one shot output time. During that time, the count display does not change from that at count-up completion. Reset occurs simultaneous with output OFF.	<p>* n: Set value</p>

Input connections

• Signal input type

1) Open collector

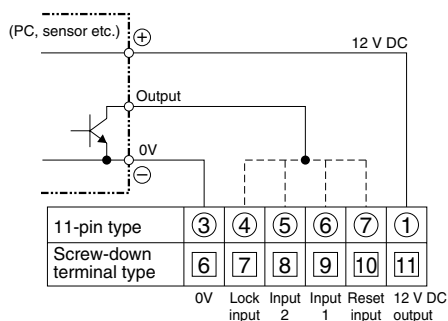

2) For voltage output

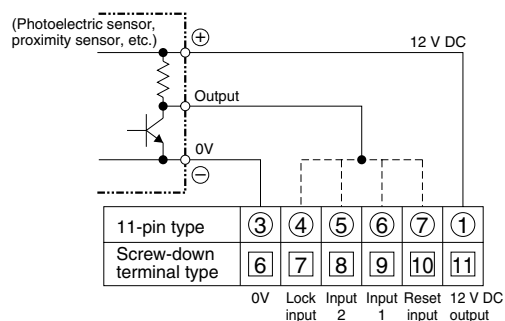

3) Contact input

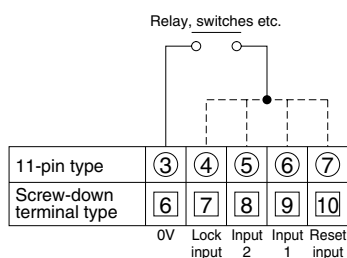

4) For a rotary encoder

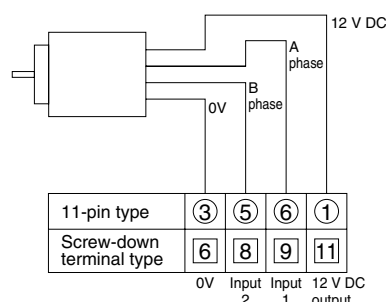

Input 1, input 2, and reset input specifications

- Impedance during short-circuit: 1 kΩ max. (At 0 Ω, the outflow current is approximately 12 mA.)
- Residual voltage during short-circuit: 2 V max.
- Impedance when released: 100 kΩ min.
- Max. applied voltage: 40 VDC max.

Lock input specifications

- Impedance during short-circuit: 1 kΩ max. (At 0 Ω, the outflow current is approximately 1.5 mA.)
- Residual voltage during short-circuit: 2 V max.
- Impedance when released: 100 kΩ min.
- Max. applied voltage: 40 DVC max.
- The contact relay should be one which can open/close 5 V, 1.5 mA.

* There is no 12 V DC with 12 - 24 V DC/24 V AC types.

5) For a dual-line sensor

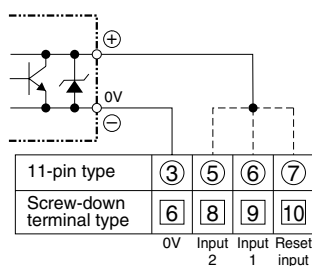

Dual-line sensor specifications

- Leakage current: 1.5 mA max.
- Breaker capacitance: 5 mA min.
- Residual voltage: 3.0 V max.
- Usable voltage: Runs on 10 VDC

* If a dual-line sensor is connected to a 12 - 24 VDC/24 VAC type, 24 VDC (21.6 to 26.4 VDC) and 24 VAC (21.6 to 26.4 VAC) should be applied to the power supply voltage of the counter.

What is the prescale function?

The prescale function converts the count into an actual value (amount) and displays it.

Example

For a device that outputs 500 pulses when 1 m has been fed:

1. Set decimal position to the last 3rd place.
2. Set the prescale value to 0.002 (1/500).

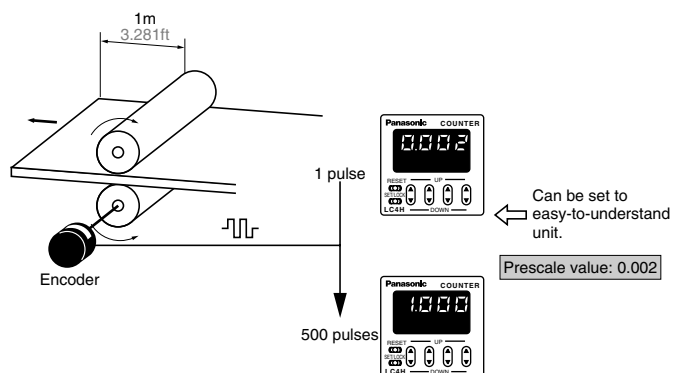

UL File No.: E122222
C-UL File No.: E122222



Features

1. Two-stage presetting (upper and lower limits)

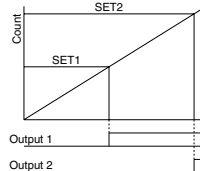

2. Bright and Easy-to-Read Display

A brand new bright 2-color backlight LCD display. The easy-to-read screen in any location makes checking and setting procedures a cinch.

3. Simple Operation

Seesaw buttons make operating the unit even easier than before.

4. Short Body of only 64.5 mm 2.539 inch (screw type) or 70.1 mm 2.760 inch (pin type)

With a short body, it easily installs in even narrow control panels.

5. Conforms to IP66's Weather Resistant Standards

The water-proof panel keeps out water and dirt for reliable operation even in poor environments.

6. Screw terminal and Pin Type are Both Standard Options

The two terminal types are standard options to support either front panel installation or embedded installation.

7. Changeable Panel Cover

Also offers a black panel cover to meet your design considerations.

8. Compliant with UL, c-UL and CE.

9. Low Price

All this at an affordable price to provide you with unmatched cost performance.

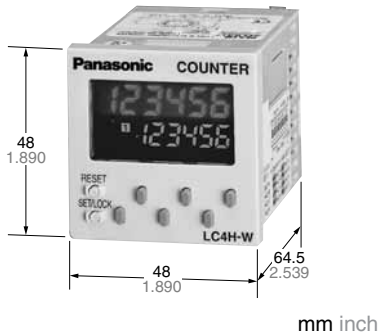

11-pin type



Screw terminal type

RoHS Directive compatibility information
<http://www.nais-e.com/>

Product types

Digit	Count speed	Output mode		Output	Operating voltage	Power down insurance	Terminal type	Part number
		Output 1	Output 2					
6	30 Hz (cps)/ 5 KHz (Kcps) switchable	<ul style="list-style-type: none"> Maintain output/over count I Maintain output/over count II Maintain output/over count III One shot/over count (4 modes) 	<ul style="list-style-type: none"> Maintain output/hold count Maintain output/over count I Maintain output/over count II Maintain output/over count III One shot/over count One shot/recount I One shot/recount II One shot/hold count (8 modes) 	Relay (1a+1a)	100 to 240 V AC	Available	11 pins	LC4H-W-R6-AC240V
					24V AC		Screw terminal	LC4H-W-R6-AC240VS
					12 to 24 V DC		11 pins	LC4H-W-R6-AC24V
							Screw terminal	LC4H-W-R6-AC24VS
					100 to 240 V AC		11 pins	LC4H-W-R6-DC24V
							Screw terminal	LC4H-W-R6-DC24VS
				Transistor (1a+1a)	100 to 240 V AC		11 pins	LC4H-W-T6-AC240V
					24V AC		Screw terminal	LC4H-W-T6-AC240VS
					12 to 24 V DC		11 pins	LC4H-W-T6-AC24V
							Screw terminal	LC4H-W-T6-AC24VS
					12 to 24 V DC		11 pins	LC4H-W-T6-DC24V
							Screw terminal	LC4H-W-T6-DC24VS

* A rubber gasket (ATC18002) and a mounting frame (AT8-DA4) are included.

Part names

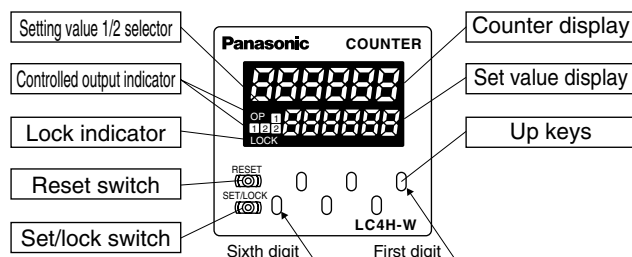

UP keys : Used to set the corresponding digits for the count-up mode.

RESET key : Used to reset counting and its output.

SET/LOCK key : Used to select between the Setting 1 display and Setting 2 display and to lock the keys (UP and RESET keys not responsive to touch). Used also to set and confirm the input mode.

Specifications

Item		Relay output type		Transistor output type	
		AC type	DC type	AC type	DC type
Rating	Rated operating voltage	100 to 240 V AC 24 V AC	12 to 24 V DC	100 to 240 V AC 24 V AC	12 to 24 V DC
	Rated frequency	50/60 Hz common	—	50/60 Hz common	—
	Rated power consumption	Max. 10 V A	Max. 3 W	Max. 10 V A	Max. 3 W
	Rated control capacity	3 A, 250 V AC (resistive load)		100 mA, 30 V DC	
	Input mode	Addition (UP)/Subtraction (DOWN)/Direction (DIR)/Individuality (IND)/Phase (PHASE) (5 modes selectable by DIP switch)			
	Counting speed	30 Hz(cps)/5 KHz(cps) (selectable by DIP switch)			
	Counting input (Input 1, 2)	Min. input signal width: 16.7 ms at 30 Hz(cps)/0.1 ms at 5 KHz(cps) ON time: OFF time = 1:1			
	Reset input	Min. input signal width: 1 ms, 20 ms (selected by DIP switch)			
	Input signal	Contact or Open collector input/Input impedance: 1 kΩ or less, Input residual voltage: 2 V or less, Open impedance: 100 kΩ or more, Max. energized voltage: 40 V DC			
	Output mode	Output 1. HOLD-B, C, D SHOT-A (4 modes) Output 2. HOLD-A, B, C SHOT-A, B, C, D (8 modes) (selectable by DIP switch)			
	One shot output time	Approx. 1 s			
	Indication	7-segment LCD, Counter value (backlight red LED), Setting value (backlight yellow LED)			
	Digit	-99999 to 999999 (-5 digits to 6 digits) (0 to 999999 for setting)			
	Memory	EEP-ROM (Overwriting times: 10 ⁵ ope. or more)			
Contact	Contact arrangement	1 Form A + 1 Form A		1 Form A + 1 Form A (Open collector)	
	Contact resistance (Initial value)	100 mΩ (at 1 A 6 V DC)		—	
	Contact material	Ag alloy/Au flush		—	
Life	Mechanical (contact)	Min. 2 × 10 ⁷ ope.		—	
	Electrical (contact)	Min. 10 ⁵ ope. (At rated control voltage)		Min. 10 ⁷ ope. (At rated control voltage)	
Electrical	Allowable operating voltage range	85 to 110 % of rated operating voltage			
	Break down voltage (Initial value)	Between live and dead metal parts: 2,000 Vrms for 1 min (pin type) Between input and output: 2,000 Vrms for 1 min Between open contacts: 1,000 Vrms for 1 min		Between live and dead metal parts: 2,000 Vrms for 1 min Between input and output: 2,000 V AC for 1 min	
	Insulation resistance (At 500 V DC) (Initial value)	Between live and dead metal parts: Min. 100 MΩ (pin type) Between input and output: Min. 100 MΩ Between open contact: Min. 100 MΩ		Between live and dead metal parts: Min. 100 MΩ (pin type) Between input and output: Min. 100 MΩ	
	Temperature rise	Max. 65°C (under the flow of nominal operating current at nominal voltage)		—	
Mechanical	Vibration resistance	Functional	10 to 55 Hz (1 cycle/min), single amplitude: 0.35 mm (10 min on 3 axes)		
		Destructive	10 to 55 Hz (1 cycle/min), single amplitude: 0.75 mm (1 h on 3 axes)		
	Shock resistance	Functional	Min. 98 m/s ² (4 times on 3 axes)		
		Destructive	Min. 294 m/s ² (5 times on 3 axes)		
Operating conditions	Ambient temperature	-10°C to 55°C +14°F to +131°F			
	Ambient humidity	Max. 85 % RH (non-condensing)			
	Air pressure	860 to 1,060 h Pa			
	Ripple rate	—	20 % or less	—	20 % or less
Connection	11-pin/screw terminal				
Protective construction	IP66 (front panel with a rubber gasket)				

Applicable standard

Safety standard	EN61812-1	Pollution Degree 2/Overvoltage Category II
EMC	(EMI)EN61000-6-4 Radiation interference electric field strength	EN55011 Group1 ClassA EN55011 Group1 ClassA
	Noise terminal voltage (EMS)EN61000-6-2 Static discharge immunity	EN61000-4-2 4 kV contact 8 kV air
	RF electromagnetic field immunity	EN61000-4-3 10 V/m AM modulation (80 MHz to 1 GHz) 10 V/m pulse modulation (895 MHz to 905 MHz)
	EFT/B immunity	EN61000-4-4 2 kV (power supply line) 1 kV (signal line)
	Surge immunity	EN61000-4-5 1 kV (power line)
	Conductivity noise immunity	EN61000-4-6 10 V/m AM modulation (0.15 MHz to 80 MHz)
	Power frequency magnetic field immunity	EN61000-4-8 30 A/m (50 Hz)
	Voltage dip/Instantaneous stop/Voltage fluctuation immunity	EN61000-4-11 10 ms, 30% (rated voltage) 100 ms, 60% (rated voltage) 1,000 ms, 60% (rated voltage) 5,000 ms, 95% (rated voltage)

LC4H-W

Dimensions

• LC4H-W electrical counter

mm inch
General tolerance: $\pm 1.0 \pm .039$

Screw terminal type (Flush mount): M3.5

Pin type (Flush mount/Surface mount)

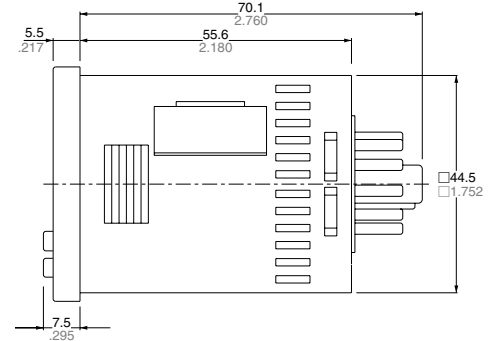
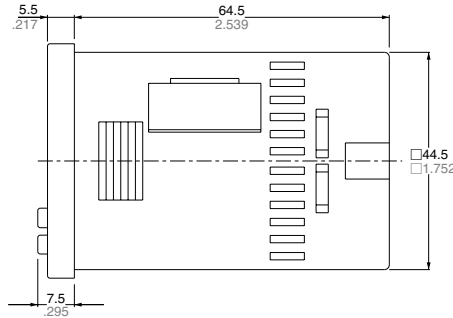
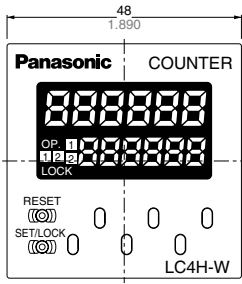

• Dimensions for flush mounting (with adapter installed)

Screw terminal type

Pin type

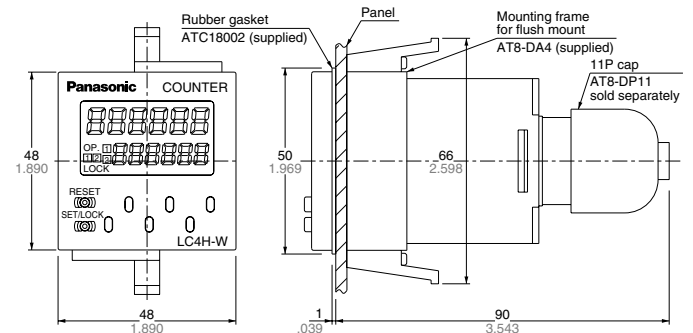
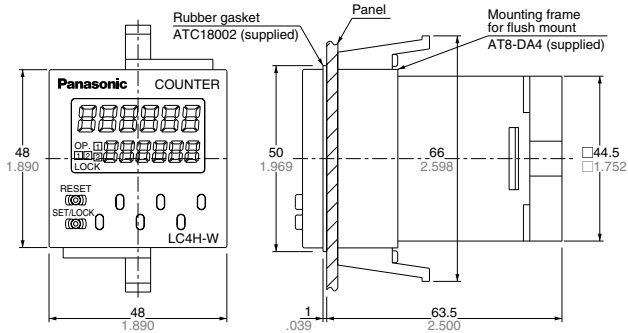

• Dimensions for front panel installations

• Installation panel cut-out dimensions

• For connected installations

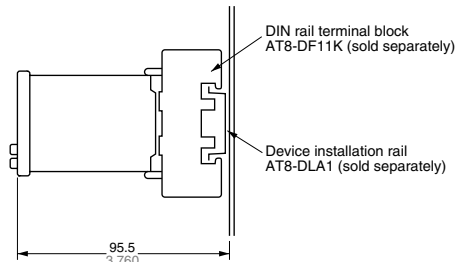

The standard panel cut-out dimensions are shown below. Use the mounting frame (AT8-DA4) and rubber gasket (ATC18002).

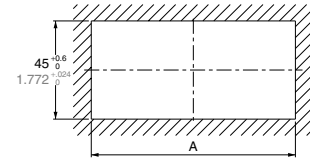
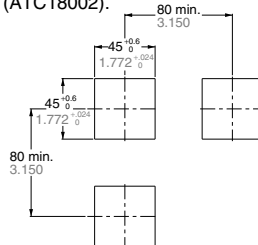

When n units are attached in a continuous series, the dimension of (A) is:

$$A = (48 \times n - 2.5) \text{ mm}$$

Note 1): The installation panel thickness should be between 1 and 5 mm (.039 and .197 inch).

2): For connected installations, the waterproofing ability between the unit and installation panel is lost.

Terminal layouts and Wiring diagrams

• Pin type

Relay output type

Transistor output type

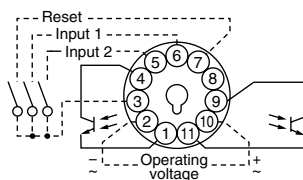
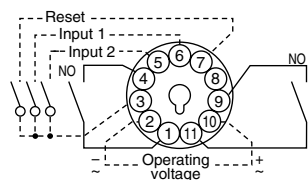

• Screw terminal type

Relay output type

Transistor output type

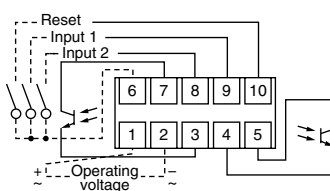
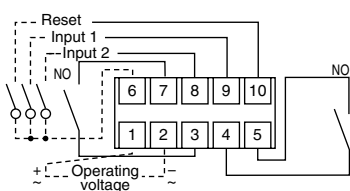

Note) For connecting the output leads of the transistor output type, refer to 5) Transistor output on page 141.

Setting the operation mode and counter

Setting procedure 1) Setting the output mode (output 1, 2)

Set the output 1 and output 2 with the DIP switches on the side of the counter.

The minimum input signal width and maximum counting speed for the reset are set at the same time.

DIP switches

Item	OFF	ON
1	Refer to table 1	
2		
3		
4	20ms	1ms
5	30Hz	5kHz
6	Refer to table 2	
7		
8		

Table 1

DIP switch No.			Output mode (Output 1)
1	2	3	
ON	ON	ON	— (See note 1)
OFF	OFF	OFF	HOLD-B
ON	OFF	OFF	HOLD-C
OFF	ON	OFF	HOLD-D
ON	ON	OFF	SHOT-A
OFF	OFF	ON	— (See note 1)
ON	OFF	ON	— (See note 1)
OFF	ON	ON	— (See note 1)

Table 2

DIP switch No.			Output mode (Output 2)
6	7	8	
ON	ON	ON	HOLD-A
OFF	OFF	OFF	HOLD-B
ON	OFF	OFF	HOLD-C
OFF	ON	OFF	HOLD-D
ON	ON	OFF	SHOT-A
OFF	OFF	ON	SHOT-B
ON	OFF	ON	SHOT-C
OFF	ON	ON	SHOT-D

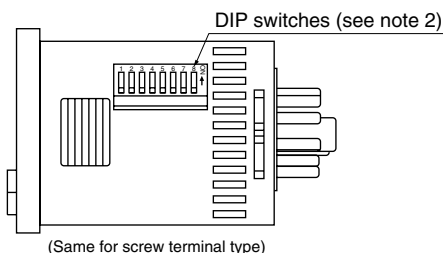

- Notes: 1) The counter and set value displays will display DIP Err.
 2) Set the DIP switches before installing the counter on the panel.
 3) When the DIP SW setting is changed, turn off the power once.
 4) The DIP switches are set as ON before shipping.

Setting procedure 2) Setting the set value

Set the set value with the UP keys on the front of the counter.

Front display section

- ① Counter display
- ② Set value display
- ③ Controlled output indicator
- ④ Setting 1/2 selection display (*Note)
- ⑤ Lock indicator

*Note:
 Pressing the [SET/LOCK] key switches the display between the set value 1 and 2 displays.
 Display either set value [1] or [2], and set the value.

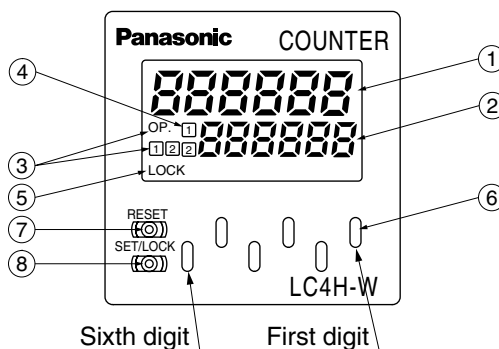

- ⑥ UP keys
 [Changes the corresponding digit of the set value in the addition direction (upwards)]
- ⑦ RESET switch
 Resets the counting value and the output
- ⑧ SET/LOCK switch
 Used to select between the Setting 1 display and Setting 2 display, to set and confirm the input mode, and to lock the keys (UP and RESET keys not responsive to touch).

Procedure 3) Setting the input mode

Set the input mode using the key and switch in the front display section on the counter front.

- (1) Hold down the SET/LOCK key and press the UP key for the first digit. The setting mode is accessed.
- (2) Now release the SET/LOCK key.
- (3) Press the UP key for the first digit and the input position changes counterclockwise.

Example)
 Input mode displayed (UP: addition mode)

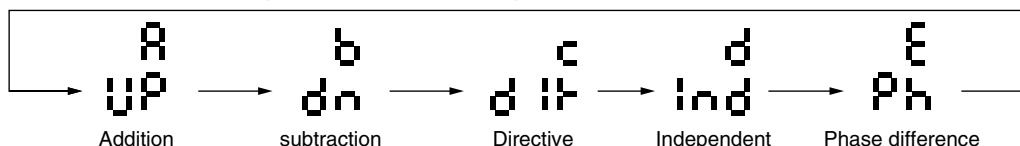

- (4) Press the RESET key and the input mode being displayed is set. The display then goes back to normal.

• Checking the input mode

Hold down the SET/LOCK key and press the UP key for the second digit. The input mode is displayed for about 2 seconds and then the display goes back to normal. (During these 2 seconds, all operations other than the display are being performed.)

• Locking the keys

Hold down the SET/LOCK key and press the UP key for the sixth digit. The keys will lock. This means that the UP and RESET keys do not respond to touch. To unlock the keys, hold down the SET/LOCK key and press the UP key for the sixth digit again.

* The input mode, maximum counting speed and minimum reset signal width cannot be preset independently for Setting 1 and Setting 2.

• Selecting the Setting 1 or Setting 2 display

Press the SET/LOCK key and the display changes between Setting 1 and Setting 2. (This operation does not affect overall operation.)

• Changing the setting

1. While the counter is working, the UP key can be used to change the setting. Keep the following points in mind, however.

- 1) Suppose that a preset count-up value is smaller than the displayed count value. The counter counts up to the full scale mark (999999), goes back to "0", and counts up again to the preset number. When the preset count-up value is larger than the displayed count value, the counter counts up to the preset value.
- 2) Suppose that the counter is preset to count down. Whether a preset count-down value is smaller or larger than the count value, the counter counts down to "0".

2. When the preset value is "0", the counter does not start in the count-up mode. It starts counting up when the count value comes to "0" again.

- 1) Up-count input
 The counter counts up to the full scale mark (999999), goes back to "0" and starts counting up again.
- 2) Down-count input
 The counter counts down to the full scale mark (-99999) and the display reads = = = = = . The count value does not become "0" and so the counter does not count up.
- 3) Direction input, individual input, and phase input
 The preset value is counted up or down to any number other than "0" once. When it comes to "0" again, the counter starts counting up.

Operation modes

1. Input mode

① For the input mode, you can choose one of the following five modes.

- Addition UP
- Subtraction DOWN
- Directive DIR
- Independent IND
- Phase PHASE

② After the counter has been reset, setting 2 is displayed in the count-down mode. "0" appears instead in all other modes.

Input mode	Operation	*Minimum input signal width 30 Hz: 16.7 ms; 5 kHz: 0.1 ms
Addition UP	IN1 or IN2 works as an input block (gate) for the other input.	<p>• Example where IN1 is the counting input and IN2 is the input block (gate).</p> <p>Counting (addition) 0 1 2 3 ---- n-3 n-2 n-1 n</p> <p>Counting (subtraction) n n-1 n-2 n-3 ---- 3 2 1 0</p> <p style="text-align: center;">△ Reset △ Count UP</p>
Subtraction DOWN		<p>• Example where IN2 is the counting input and IN1 is the input block (gate).</p> <p>Counting (addition) 0 1 2 3 4 ---- n-1 n</p> <p>Counting (subtraction) n n-1 n-2 n-3 n-4 ---- 1 0</p> <p style="text-align: center;">△ Reset △ Count UP</p>
Directive DIR	IN1 is the counting input and IN2 is the addition or subtraction directive input. IN2 adds at L level and subtracts at H level.	<p>Counting 0 1 2 3 4 3 2 1 0 1 2 3 4</p> <p style="text-align: center;">△ Reset</p>
Independent IND	IN1 is addition input and IN2 is subtraction input.	<p>Counting 0 1 2 3 4 3 2 1 2 1 2 3</p> <p style="text-align: center;">△ Reset</p>
Phase PHASE	Addition when the IN1 phase advances beyond IN2, and subtraction when the IN2 phase advances beyond IN1.	<p>Counting 0 1 2 3 2 1 0</p> <p style="text-align: center;">△ Reset</p>

* "A" must be more than the minimum input signal width. *n: Set value 2

* "A" must be more than the minimum input signal width. *n: Set value 2

* IN1 and IN2 are completely independent, so there is no restriction on signal timing.

* "B" must be more than the minimum input signal width.

2. Output mode

For the set value 1, you can choose one of the following four modes.

- Maintain output/over count I HOLD-B
- Maintain output/over count II HOLD-C
- Maintain output/over count III HOLD-D
- One shot/over count SHOT-A

For the set value 2, you can choose one of the following eight modes.

- Maintain output/hold count HOLD-A
- Maintain output/over count I HOLD-B
- Maintain output/over count II HOLD-C
- Maintain output/over count III HOLD-D
- One shot/over count SHOT-A
- One shot/recount I SHOT-B
- One shot/recount II SHOT-C
- One shot/hold count SHOT-D

• Output mode for set value 1

Output mode	Operation	(Example when input mode is either addition or subtraction)
Maintain output Over count I HOLD-B	Output control is maintained after count-up completion and until resetting. However, counting is possible despite completion of count-up.	<p>* n: Set value 1</p>
Maintain output Over count II HOLD-C	Output control is maintained after count-up completion and until the next signal enters. However, counting is possible despite completion of count-up.	<p>* n: Set value 1</p>
Maintain output Over count III HOLD-D	If the count value is greater than or equal to the preset value when counting up, the control output is held. The count operation is possible anyway.	<p>* n: Set value 1</p>
One shot Over count SHOT-A	Output control is maintained after count-up completion for a fixed time (approx. 1 sec). Counting is possible despite completion of count-up.	<p>* n: Set value 1</p>

• Output mode for set value 2

Output mode	Operation	(Example when input mode is either addition or subtraction)																		
Maintain output Hold count HOLD-A	Output control is maintained after count-up completion and until resetting. During that time, the count display does not change from that at count-up completion.	<p>Counting (addition) <table border="1"><tr><td>-----</td><td>n-3</td><td>n-2</td><td>n-1</td><td>n</td></tr></table></p> <p>Counting (subtraction) <table border="1"><tr><td>-----</td><td>3</td><td>2</td><td>1</td><td>0</td></tr></table></p> <p>Counting able/unable </p> <p>Output control 2 <table border="1"><tr><td>OFF</td><td>ON</td></tr></table></p> <p>* n: Set value 2</p>	-----	n-3	n-2	n-1	n	-----	3	2	1	0	OFF	ON						
-----	n-3	n-2	n-1	n																
-----	3	2	1	0																
OFF	ON																			
Maintain output Over count I HOLD-B	Output control is maintained after count-up completion and until resetting. However, counting is possible despite completion of count-up.	<p>Counting (addition) <table border="1"><tr><td>-----</td><td>n-2</td><td>n-1</td><td>n</td><td>n+1</td><td>n+2</td><td>-----</td></tr></table></p> <p>Counting (subtraction) <table border="1"><tr><td>-----</td><td>2</td><td>1</td><td>0</td><td>-1</td><td>-2</td><td>-----</td></tr></table></p> <p>Counting able/unable </p> <p>Output control 2 <table border="1"><tr><td>OFF</td><td>ON</td></tr></table></p> <p>* n: Set value 2</p>	-----	n-2	n-1	n	n+1	n+2	-----	-----	2	1	0	-1	-2	-----	OFF	ON		
-----	n-2	n-1	n	n+1	n+2	-----														
-----	2	1	0	-1	-2	-----														
OFF	ON																			
Maintain output Over count II HOLD-C	Output control is maintained after count-up completion and until the next signal enters. However, counting is possible despite completion of count-up.	<p>Counting (addition) <table border="1"><tr><td>-----</td><td>n-2</td><td>n-1</td><td>n</td><td>n+1</td><td>n+2</td><td>-----</td></tr></table></p> <p>Counting (subtraction) <table border="1"><tr><td>-----</td><td>2</td><td>1</td><td>0</td><td>-1</td><td>-2</td><td>-----</td></tr></table></p> <p>Counting able/unable </p> <p>Output control 2 <table border="1"><tr><td>OFF</td><td>ON</td><td>OFF</td></tr></table></p> <p>* n: Set value 2</p>	-----	n-2	n-1	n	n+1	n+2	-----	-----	2	1	0	-1	-2	-----	OFF	ON	OFF	
-----	n-2	n-1	n	n+1	n+2	-----														
-----	2	1	0	-1	-2	-----														
OFF	ON	OFF																		
Maintain output Over count III HOLD-D	If the count value is greater than or equal to the preset value when counting up, the counter starts counting up again. The count operation is possible anyway.	<p>Counting (addition) <table border="1"><tr><td>-----</td><td>n-2</td><td>n-1</td><td>n</td><td>n+1</td><td>n+2</td><td>-----</td></tr></table></p> <p>Counting (subtraction) <table border="1"><tr><td>-----</td><td>2</td><td>1</td><td>0</td><td>-1</td><td>-2</td><td>-----</td></tr></table></p> <p>Counting able/unable </p> <p>Output control 2 (addition) <table border="1"><tr><td>OFF</td><td>ON</td></tr></table></p> <p>Output control 2 (subtraction) <table border="1"><tr><td>OFF</td><td>ON</td></tr></table></p> <p>* n: Set value 2</p>	-----	n-2	n-1	n	n+1	n+2	-----	-----	2	1	0	-1	-2	-----	OFF	ON	OFF	ON
-----	n-2	n-1	n	n+1	n+2	-----														
-----	2	1	0	-1	-2	-----														
OFF	ON																			
OFF	ON																			
One shot Over count SHOT-A	Output control is maintained after count-up completion for a fixed time (approx. 1 sec). Counting is possible despite completion of count-up.	<p>Counting (addition) <table border="1"><tr><td>-----</td><td>n-2</td><td>n-1</td><td>n</td><td>n+1</td><td>n+2</td><td>-----</td></tr></table></p> <p>Counting (subtraction) <table border="1"><tr><td>-----</td><td>2</td><td>1</td><td>0</td><td>-1</td><td>-2</td><td>-----</td></tr></table></p> <p>Counting able/unable </p> <p>Output control 2 <table border="1"><tr><td>OFF</td><td>ON (Approx. 1s)</td><td>OFF</td></tr></table></p> <p>* n: Set value 2</p>	-----	n-2	n-1	n	n+1	n+2	-----	-----	2	1	0	-1	-2	-----	OFF	ON (Approx. 1s)	OFF	
-----	n-2	n-1	n	n+1	n+2	-----														
-----	2	1	0	-1	-2	-----														
OFF	ON (Approx. 1s)	OFF																		
One shot Recount I SHOT-B	Output control is maintained after count-up completion for a fixed time (approx. 1 sec). Counting is possible despite completion of count-up. However, reset occurs simultaneous with completion of count-up. While output is being maintained, restarting of the count is not possible.	<p>Counting (addition) <table border="1"><tr><td>-----</td><td>n-2</td><td>n-1</td><td>0</td><td>1</td><td>2</td><td>-----</td></tr></table></p> <p>Counting (subtraction) <table border="1"><tr><td>-----</td><td>2</td><td>1</td><td>n</td><td>n-1</td><td>n-2</td><td>-----</td></tr></table></p> <p>Counting able/unable </p> <p>Output control 2 <table border="1"><tr><td>OFF</td><td>ON (Approx. 1s)</td><td>OFF</td></tr></table></p> <p>* n: Set value 2</p>	-----	n-2	n-1	0	1	2	-----	-----	2	1	n	n-1	n-2	-----	OFF	ON (Approx. 1s)	OFF	
-----	n-2	n-1	0	1	2	-----														
-----	2	1	n	n-1	n-2	-----														
OFF	ON (Approx. 1s)	OFF																		

Output mode	Operation	(Example when input mode is either addition or subtraction)
One shot Recount II SHOT-C	Output control is maintained after count-up completion for a fixed time (approx. 1 sec). Counting is possible despite completion of count-up. However, reset occurs simultaneous with output OFF.	<p>* n: Set value 2</p>
One shot Hold count SHOT-D	Output control is maintained after count-up completion for a fixed time (approx. 1 sec). During that time, the count display does not change from that at count-up completion. Reset occurs simultaneous with output OFF.	<p>* n: Set value 2</p>

		Output mode for set value 1			
		HOLD-C	HOLD-D	HOLD-B	SHOT-A
Output mode for set value 2	SHOT-A	As usual (this combination unchanged)		As usual (this combination unchanged)	
	SHOT-B				
	SHOT-C SHOT-D				

Note) When control output 1 is on, the output mode of setting 2 (SHOT-A, B, C, D) is also on and output 1 changes as shown in the above table.

3. Count-up

(1) In control output 1, when the count value is equal to the preset value 1, it is counted. (However, if the output mode of the preset value 1 is HOLD-D, it is counted when the count value is greater than or equal to the preset value 1, regardless of the input mode.)

(2) In control output 2, when the count value is equal to 0 in the count-down input mode, it is counted. In the other modes, when the count value is equal to the preset value 2, it is counted. (However, if the output mode of the preset value 2 is HOLD-D, it is counted when the count value is greater than or equal to the preset value 2, regardless of the input mode.)

(3) It is not counted even when the counting conditions are satisfied right after resetting. It can be counted from when the count value changes.

PRECAUTIONS IN USING THE LC4H SERIES

Precautions during usage

1. Terminal wiring

1) When wiring the terminals, refer to the terminal layout and wiring diagrams and be sure to perform the wiring properly without errors.

2) When using the instrument with an flush mounting, the screw-down terminal type is recommended. For the pin type, use either the rear terminal block (AT78041) or the 8P cap (AD8-RC) for the 8-pin type, and the rear terminal block (AT78051) or the 11P cap (AT8-DP11) for the 11-pin type. Avoid soldering directly to the round pins on the unit. When using the instrument with a front panel installation, use the DIN rail terminal block (AT8-DF8K) for the 8-pin type and the DIN rail terminal block (AT8-DF11K) for the 11-pin type.

3) After turning the counter off, make sure that any resulting induced voltage or residual voltage is not applied to power supply terminals ② through ⑦ (8-pin type), ② through ⑩ (11-pin type) or ① and ② (screw terminal type). (If the power supply wire is wired parallel to the high voltage wire or power wire, an induced voltage may be generated between the power supply terminals.)
4) Have the power supply voltage pass through a switch or relay so that it is applied at one time. If the power supply is applied gradually, the counting may malfunction regardless of the settings, the power supply reset may not function, or other such unpredictable occurrence may result.

2. Input connections (except LC4H-S/AC type)

The power circuit has no transformer (power and input terminals are not insulated). When an input signal is fed to two or more counters at once, do not arrange the power circuit in an independent way.

If the counter is powered on and off independently as shown in Fig. A, the counter's internal circuitry may get damaged. Be careful never to allow such circuitry. (Figs. A, B and C show the circuitry for the 11-pin type.)

(Fig. A)

Input contact or transistor

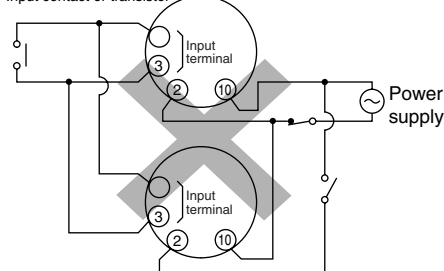

If independent power circuitry must be used, keep the input contacts or transistors separate from each other, as shown in Fig. B.

(Fig. B)

Input contact or transistor

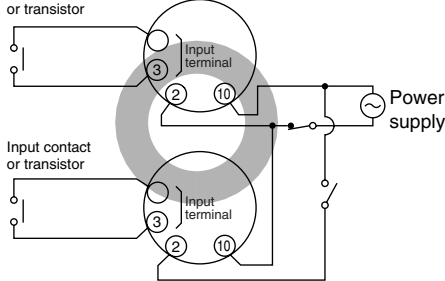

When power circuitry is not independent, one input signal can be fed to two or more counters at once, as shown in Fig. C.

(Fig. C)

Input contact or transistor

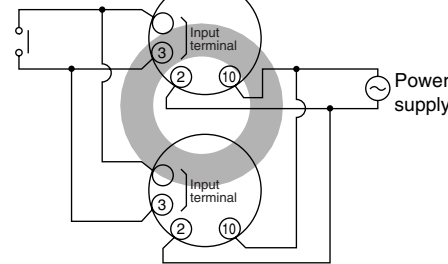

3. Input and output

1) Signal input type

(1) Contact point input

Use highly reliable metal plated contacts. Since the contact point's bounce time leads directly to error in the count value, use contacts with as short a bounce time as possible. In general, select Input 1 and Input 2 to have a maximum counting speed of 30 Hz and to be reset with a minimum input signal width of 20 ms.

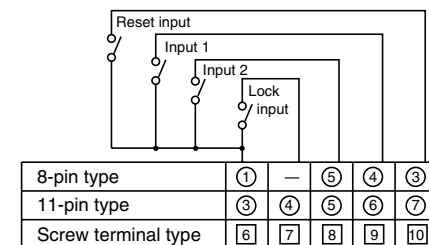

Note: The LC4H-W does not have the lock input ④, ⑦.

(2) Non-contact point input

Connect with an open collector. Use transistors whose characteristics satisfy the criteria given below.

$V_{CE0} = 20 \text{ V min.}$

$I_C = 20 \text{ mA min.}$

$I_{CBO} = 6\mu\text{A max.}$

Also, use transistors with a residual voltage of less than 2 V when the transistor is on.

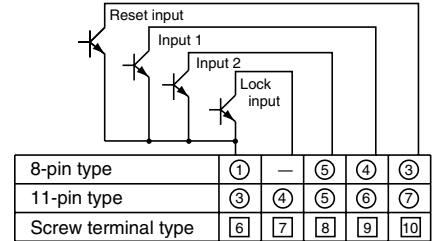

Note: The LC4H-W does not have the lock input ④, ⑦.

* The short-circuit impedance should be less than 1 k Ω .

[When the impedance is 0 Ω , the current coming from the input 1 and input 2 terminals is approximately 12 mA, and from the reset input and lock input terminals is approximately 1.5 mA.]

Also, the open-circuit impedance should be more than 100 k Ω .

* As shown in the diagram below, from a non-contact point circuit (proximity switches, photoelectric switches, etc.) with a power supply voltage of between 12 and 40 V, the signal can be input without using an open collector transistor. In the case of the diagram below, when the non-contact point transistor Q switches from off to on (when the signal voltage goes from high to low), the signal is input.

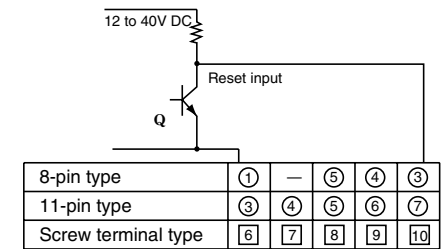

(The above example is for reset input)

2) The input mode and output mode change depending on the DIP switch settings. Therefore, before making any connections, be sure to confirm the operation mode and operation conditions currently set.

PRECAUTIONS IN USING THE LC4H SERIES

3) The LC4H series use power supply without a transformer (power and input terminals are not insulated). In connecting various kinds of input signals, therefore, use a power transformer in which the primary side is separated from the ungrounded secondary side as shown in Fig. A, for the power supply for a sensor and other input devices so that short-circuiting can be prevented.

Once the wiring to be used is completely installed and prior to installing this counter, confirm that there is complete insulation between the wires connected to the power terminals (2 each) and the wires connected to each input terminal. If the power and input lines are not insulated, a short-circuit may occur inside the counter and result in internal damage. In addition, when moving your equipment to a new installation location, confirm that there is no difference in environmental conditions as compared to the previous location.

(except LC4H-S/AC type)

(Fig. A) Good example

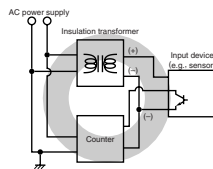

(Fig. B) Bad example

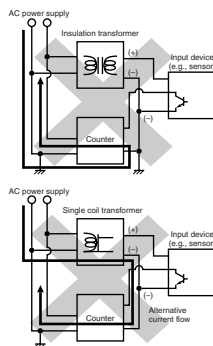

4) The input signal is applied by the shorting of each input terminal with the common terminal (terminal ① for 8-pin type, terminal ③ for 11-pin type and terminal ⑥ for screw terminal types). Never connect other terminals or voltages higher than 40 V DC, because it may destroy the internal circuitry.

5) Transistor output

(1) Since the transistor output is insulated from the internal circuitry by a photocoupler, it can be used as an NPN output or PNP (equal value) output. (The above example is 11-pin type)

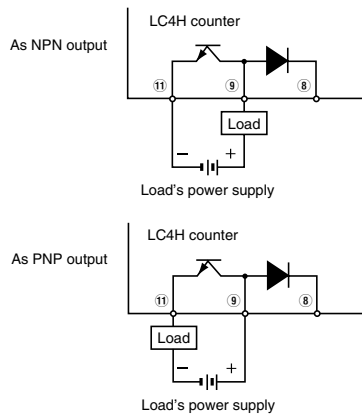

Note: With the LC4H 8-pin type and the LC4H-W, there is no diode between points ⑧ and ⑨.

(2) Use the diode connected to the output transistor's collector for absorbing the reverse voltage from induced loads. (LC4H only)

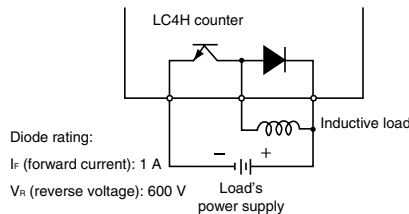

6) When wiring, use shielded wires or metallic wire tubes, and keep the wire lengths as short as possible.

4. Output mode setting

The output mode can be set with the DIP switches on the side of the counter. Make the DIP switch settings before installing the counter on the panel.

5. Conditions of usage

- 1) Avoid locations subject to flammable or corrosive gases, excessive dust, oil, vibrations, or excessive shocks.
- 2) Since the cover of the unit is made of polycarbonate resin, avoid contact with or use in environments containing methyl alcohol, benzene, thinners, and other organic solvents; and ammonia, caustic sodas, and other alkaline substances.
- 3) If power supply surges exceed the values given below, the internal circuits may become damaged. Be sure to use surge absorbing element to prevent this from happening.
- 4) Regarding external noise, the values

Operating voltage	Surge voltage (peak value)
AC type	6,000V
DC type 24V AC type	1,000V

• Surge wave form

[$\pm (1.2 \times 50)$ ms uni-polar full wave voltage]

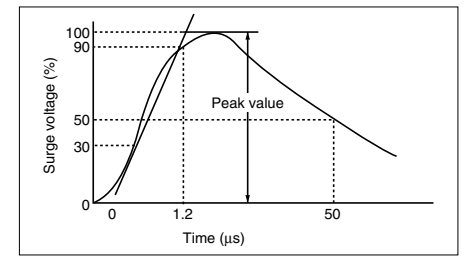

below are considered the noise-resistant voltages. If voltages rise above these values, malfunctions or damage to the internal circuitry may result, so take the necessary precautions.

Noise wave form (noise simulator)

	Power supply terminals		Input terminals
	AC type	DC type 24V AC type	
Noise voltage	1,500V	1,000V	600V

Rise time: 1 ns

Pulse width: 1 μ s, 50 ns

Polarity: \pm

Cycle: 100 cycles/second

5) When connecting the operation power supply, make sure that no leakage current enters the counter. For example, when performing contact protection, if set up like that of diagram A, leaking current will pass through C and R, enter the unit, and cause incorrect operation.

Diagram B shows the correct setup.

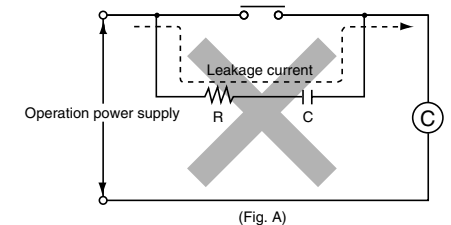

(Fig. A)

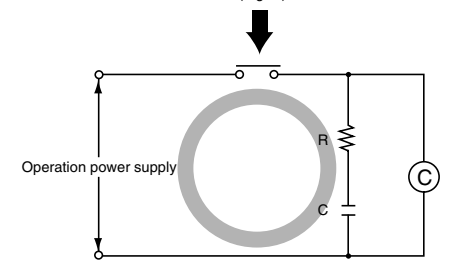

(Fig. B)

6) Long periods of continuous operation in the count-up completed condition (one month or more) will result in the weakening of the internal electrical components from the generated heat and, therefore, should be avoided. If you do plan to use the unit for such continuous operation, use in conjunction with a relay as shown in the circuit in the diagram below.

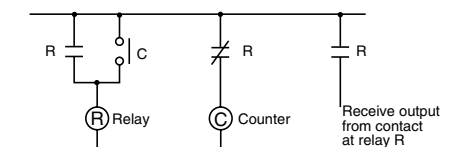

PRECAUTIONS IN USING THE LC4H SERIES

6. Self-diagnosis function

If a malfunction occurs, one of the following displays will appear.

Display	Contents	Output condition	Restoration procedure	Preset values after restoration
- - - - or - - - - -	Minimum value went below -999 or -99999. See note 1.	No change	Enter reset or RESET key.	No change
d IPFFt	Incorrect DIP switch setting.		Restart unit (correct DIP switch settings)	
Err-00	Malfunctioning CPU.	OFF	Enter reset, RESET key, or restart unit.	The values at start-up before the CPU malfunction occurred.
Err-01	Malfunctioning memory. See note 2.			0

Note 1: When the counter value goes below the minimum value during any of the subtraction, directive, independent, or phase input modes.

Note 2: Includes the possibility that the EEPROM's life has expired.

7. Compliance with the CE marking

When using in applications to which EN61812-1 applies, abide by the following conditions.

- Overvoltage category II, pollution level 2 (for sensor type model with power supply)

1. Connections between the power supply and input/output have basic insulation. Use a device with basic insulation to connect to the I/O terminals. (for sensor type model without power supply)

1) This counter employs a power supply without a transformer, so the power and input signal terminals are not insulated.









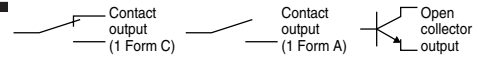









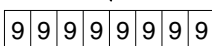

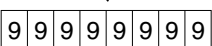





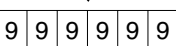

- (1) When a sensor is connected to the input circuit, install double insulation on the sensor side.
- (2) In the case of contact input, use dual-insulated relays, etc.
 - The load connected to the output contact should have basic insulation. This counter is protected with basic insulation and can be double-insulated to meet EN/IEC requirements by using basic insulation on the load.
 - Applied voltage should be protected with an overcurrent protection device (example: 250 V 1A fuse, etc.) that conforms to the EN/IEC standards.

2) You must use a terminal block or socket for installing the pin-type counter. Do not touch the terminal section or other parts of the timer unit while an electric current is applied. Before installation or removal, confirm that there is no voltage being applied to any of the terminals.

3) Do not use this timer with a safety circuit. For example, when using a timer in a heater circuit, etc., provide a protection circuit on the machine side.

COUNTERS SELECTOR CHART



Classification	Electronic counters				
Name of product	LC2H Counter	LC2H Counter	LC4H-L Counter	LC4H-S Counter	LC4H-W Counter
Type	Total counter	Preset counter	Preset counter	Preset counter	Preset counter
Input mode/Input method	UP type	UP, DOWN type	UP, DOWN, and DIR (multi-mode)/DIP switch	UP, DOWN, and DIR (multi-mode)/DIP switch	UP, DOWN, and DIR (multi-mode) 2 modes selectable/DIP switch
Appearance	Flush mounting type  PC board mounting type  AEL3	 AEL3	 4-digit display  6-digit display	 4-digit display  6-digit display	 LC4H-W
Features	8.7 mm tall 8-digit display Bright 2-color back light	8.7 mm tall 8-digit display Preset function equipped in half size Display has backlight for instant recognition	Bright and easy-to-read display Simple operation Short body Conforms to IP66's weather resistant standards	Bright and easy-to-read display Simple operation Pre-scale function Built-in power supply for high-capacity sensor (100 to 240 V AC type) Conforms to IP66's weather resistant standards	Bright and easy-to-read display Simple operation Upper and lower limit settings are available. Conforms to IP66's weather resistant standards
Rated operating voltage	Flush mounting type: Unnecessary (Built-in battery) PC board mounting type: 3 V DC (Battery in externally installed)	24 V DC	100 to 240 V AC 24 V AC, 12 to 24 V DC	100 to 240 V AC	100 to 240 V AC 24 V AC 12 to 24 V DC
Number of digits (counter capacity)	8-digit  } 	8-digit  } 	4-digit 6-digit  }  }  	4-digit 6-digit  }  }  	6-digit  } 
Counter/Indication	Zero-suppress function (LCD)	Zero-suppress function (LCD)	7-segment LCD Counter value (backlight red LED) Setting value (backlight yellow LED)	7-segment LCD Counter value (backlight red LED) Setting value (backlight yellow LED)	7-segment LCD Counter value (backlight red LED) Setting value (backlight yellow LED)
Counting speed	Flush mounting type: 2kHz/30Hz (Changeable by a switch) PC board mounting type: 2kHz/30Hz (Different type)	30Hz/5kHz (switchable)	30Hz/5kHz	30Hz/5kHz	30Hz/5kHz
Input	Counting (signal) input and reset input • Input by short-circuiting or opening contacts • Open collector input • Voltage input	Counting (signal) input and reset input • Input by short-circuiting or opening contacts • Open collector input	2-input (multi-mode) and reset input • Input by short-circuiting or opening contacts. • Open collector input	2-input (multi-mode) and reset input • Input by short-circuiting or opening contacts. • Open collector input	2-input (multi-mode) and reset input • Input by short-circuiting or opening contacts. • Open collector input
Reset (Reset input specifications conform to those of counting input)	• Front reset button and external reset input terminal • External reset dip terminal	• Manual reset with and external terminal and front reset key • Manual reset types inside one-short output models	• Manual reset with and external terminal and front reset key • Manual reset types inside one-short output models	• Manual reset with and external terminal and front reset key • Manual reset types inside one-short output models	• Manual reset with and external terminal and front reset key • Manual reset types inside one-short output models
Preset	—	• Counter number setting with key switches	• Operation mode setting with dip switches • Counter number setting with key switches	• Operation mode setting with dip switches • Counter number setting with key switches	• Output mode setting with dip switches • Counter number setting with key switches
Control output	—		 or 	 or 	 or 
Power supply output	—	—	—	External power supply 12 V DC 100 mA max. (AC type only)	—
Options	Flush mounting type (No need for easy installation type) Mounting frame, rubber gasket	Mounting frame, rubber gasket	11 P plug-in (terminal block, socket) 8 P plug-in (terminal block, socket)	11 P plug-in (terminal block, socket)	11 P plug-in (terminal block, socket)
Available standards	UL, c-UL, CE	UL, c-UL, CE	UL, c-UL, CE	UL, c-UL, CE	UL, c-UL, CE
Page	P. 98	P. 106	P. 115	P. 123	P. 132

TYPICAL COUNTER APPLICATIONS

The highly accurate, reliable counters can be controlled from the front panel and are suitable for a wide range of applications.

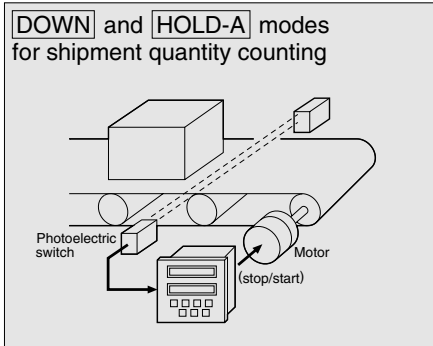

Shipment quantities are counted to control the conveyor line flow.

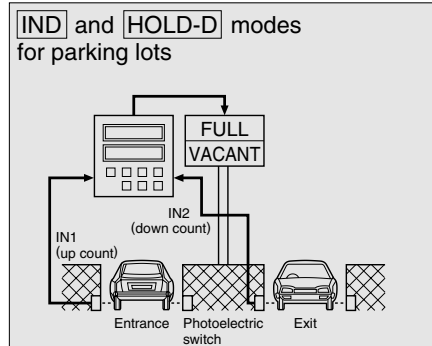

Incoming and outgoing cars are counted to switch the FULL and VACANT signs.

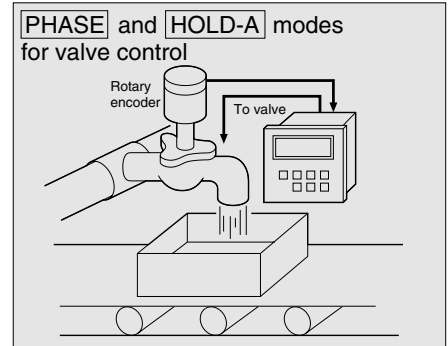

Rotary encoder signals are counted to control a valve aperture.

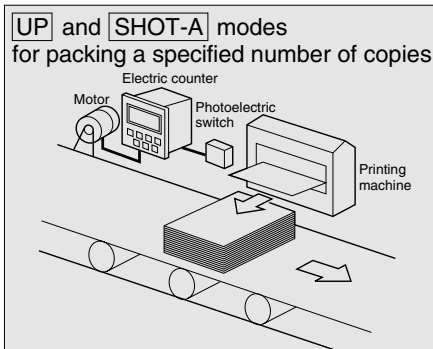

Printed matter is counted to package a specified number of copies.

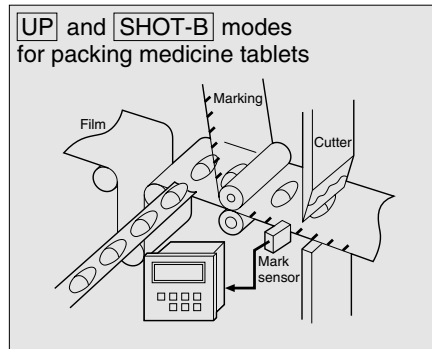

Medicine tablets are packed in specified quantities.

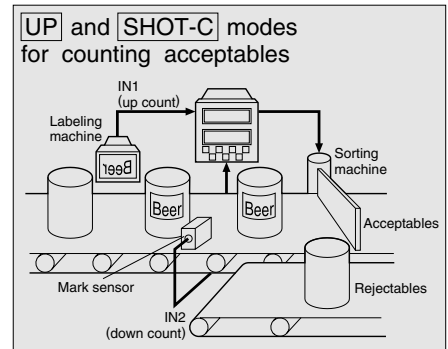

Labeled cans alone are counted up. Rejected cans are not counted.

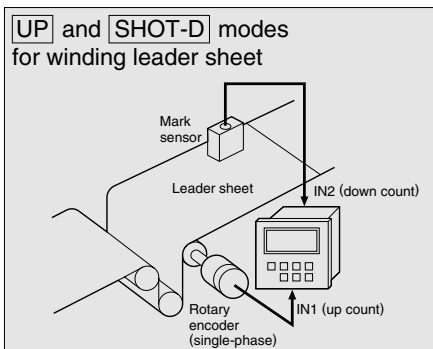

Extra leader sheet that is now wound is counted by a rotary encoder and a color detecting sensor.

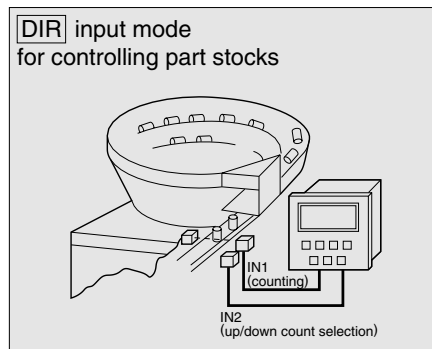

Incoming and outgoing parts are counted to keep parts feeders well-stocked.

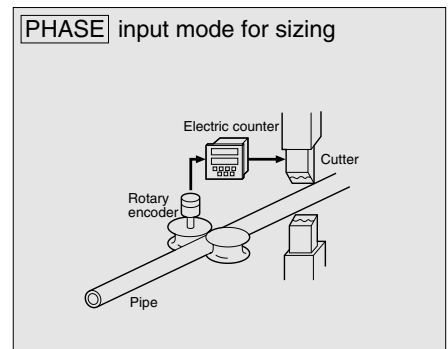

Teamed up with a rotary encoder, the counter is used to control the cutting length of pipes.

COUNTER-RELATED TERMINOLOGY

TYPES OF COUNTERS

1. Electro Preset Counter

The counter is equipped with semiconductor counting circuitry. When the counter counts up to a preset number, its output circuit sends a signal.

2. Electro Magnetic Counter

A magnet is magnetized and demagnetized to drive the dial and count up numbers.

RATING

1. Rated Operating Voltage

The voltage is applied to start the counter.

COUNTINGS

1. Pulse

This is a voltage or current signal sent at intermittent time intervals.

2. Count

Pulses are used to count up and down.

3. Miss-count

This happens if the number of pulses does not correspond to the number of counts.

4. Hertz

This unit of counting speed is used to give the number of counts per one second.

5. Make Ratio

This is the ratio of ON time (T_a) to OFF time (T_b).

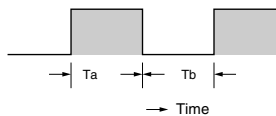

6. Maximum Counting Speed

Suppose that the counter is operated with an input pulse of a make ratio of 1. The highest counting speed is the peak of a range in which the output circuit can send signals without mis-counting. The speed is expressed in units of Hz (cps: counts per a second).

7. Over Count

Counting continues beyond a preset number.

8. Recount

When counting is up, the counter display resets to zero and counting restarts.

9. Down Count

Numbers are counted down one by one from a preset number.

10. Up Count

Numbers are counted up one by one from zero.

11. Up/Down Count

Numbers are counted up or down depending on input conditions.

12. Rejection (gate) Input

This signal is used to keep the counter from counting.

OUTPUTS

1. Count Up

When a preset number is reached, the output circuit sends a signal.

2. Retained Output

The output is held until a reset signal is sent.

3. One Shot Output

This output has a specified width of time.

RESETTINGS

1. Reset

The counting process, display and output sections are all brought back to the initial status.

2. Power off Reset

The operating voltage is turned off to reset the counter.

3. Manual Reset

The counter is manually reset.

4. Remote Reset

A signal is sent from a remote point to the reset terminal so as to reset the counter.

5. Automatic Reset

When counting is up, internal circuitry is activated to automatically reset the counter.

6. Reset Signal Width

This is the time during which the power is off so as to reset the counter or during which an external (manual) reset signal is sent.

7. Reset time

This is the time from the moment a reset signal is sent to the instant the counter is ready to start counting again.

OTHERS

1. Function of Memorizing Condition

Counting data up until the operating voltage is turned off can be stored in memory. When the power is reactivated, the data can be reproduced.

2. Anti-surge

The strength against power voltage surge is determined by applying a single-pole full-wave voltage (several hundred to several thousand volt wave for $\pm(1.2 \times 50) \mu\text{s}$) across the control power terminals.

Surge waveform

[Single-pole full-wave voltage for $\pm(1.2 \times 50) \mu\text{s}$]

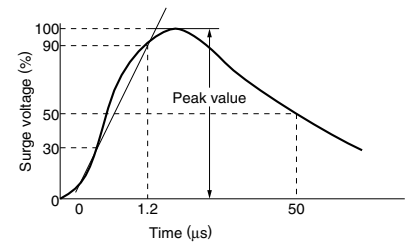

3. Noise Immunity

This is the strength against external noise. Relay noise tests, noise simulator tests, etc. are conducted.

PRECAUTIONS IN USING THE COUNTER

Cautions for circuits

1. Protective circuit for counter contact

In the circuit that switches an inductive load, a contact failure may occur at a contact point due to surge or inrush current resulting from that switching. Therefore, it is recommended that the following protective circuit be used to protect the contact point.

Circuit	CR circuit (r: resistor c: capacitor)		Diode circuit	Varistor circuit
Application	AC DC	(see note.) Available	Available Available	Not available Available
Features/Others	<p>If the load is a relay or solenoid, the release time lengthens. Effective when connected to both contacts if the power supply voltage is 24 or 48 V and the voltage across the load is 100 to 200 V.</p> <p>If the load is a timer, leakage current flows through the CR circuit causing faulty operation. Note: If used with AC voltage, be sure the impedance of the load is sufficiently smaller than that of the CR circuit.</p>		<p>The diode connected in parallel causes the energy stored in the coil to flow to the coil in the form of current and dissipates it as joule heat at the resistance component of the inductive load. This circuit further delays the release time compared to the CR circuit. (2 to 5 times the release time listed in the catalog)</p>	<p>Using the rated voltage characteristics of the varistor, this circuit prevents excessively high voltages from being applied across the contacts. This circuit also slightly delays the release time.</p>
Device Selection	<p>As a guide in selecting r and c, c: 0.5 to 1 μF per 1 A contact current r: 0.5 to 1 Ω per 1 V contact voltage Values vary depending on the properties of the load and variations in counter characteristics. Capacitor c acts to suppress the discharge the moment the contacts open. Resistor r acts to limit the current when the power is turned on the next time. Test to confirm. Use a capacitor with a breakdown voltage of 200 to 300 V. Use AC type capacitors (non-polarized) for AC circuits.</p>		<p>Use a diode with a reverse breakdown voltage at least 10 times the circuit voltage and a forward current at least as large as the load current. In electronic circuits where the circuit voltages reverse breakdown voltage of about 2 to 3 times the power supply voltage.</p>	—

2. Type of Load and Inrush Current

The type of load and its inrush current characteristics, together with the switching frequency, are important factors which cause contact welding. Particularly for loads with inrush currents, measure the steady state current and inrush current and use a relay or magnet switch which provides an ample margin of safety. The table below shows the relationship between typical loads and their inrush currents.

Type of load	Inrush current
Resistive load	Steady state current
Solenoid load	10 to 20 times the steady state current
Motor load	5 to 10 times the steady state current
Incandescent lamp load	10 to 15 times the steady state current
Mercury lamp load	1 to 3 times the steady state current
Sodium vapor lamp load	1 to 3 times the steady state current
Capacitive load	20 to 40 times the steady state current
Transformer load	5 to 15 times the steady state current

When you want large load and long life of the counter, do not control the load direct with a counter. When the counter is designed to use a relay or a magnet switch, you can acquire the longer life of the counter.

3. Connection of input (Except for LC4H-S/AC type)

The LC4H series use power supply without a transformer (power and input terminals are not insulated). In connecting

various kinds of input signals, therefore, use a power transformer in which the primary side is separated from the ungrounded secondary side as shown in Fig. A, for the power supply for a sensor and other input devices so that short-circuiting can be prevented.

(Fig. A) Good

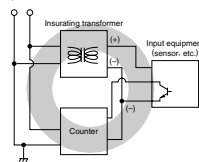

(Fig. B) No good

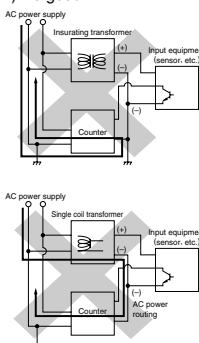

Do not use a single coil transformer (e.g., Sly-Duck). Otherwise, the internal circuit of the counter will be short-circuited as shown in Fig. B resulting in breakdown.

4. Long Continuous Current Flow

Avoid keeping the counter on for a long period of time (over one month). Otherwise heat is generated and accumulated inside the counter, which may deteriorate its electronic parts. If the counter must be kept on for a long period of time, a relay is added. See the circuit diagram below.

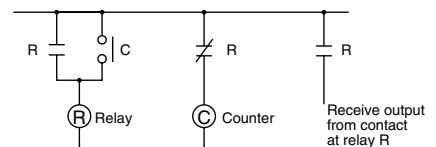

PRECAUTIONS IN USING THE COUNTER

5. Leakage current

1) For connecting operating voltage to the counter, a circuit should be used, which will prevent the flow of leakage current. For example, a circuit for contact protection as shown in Fig. A. will permit leakage current flow through R and C, causing erroneous operation of the counter. Instead, the circuit shown in Fig. B should be used.

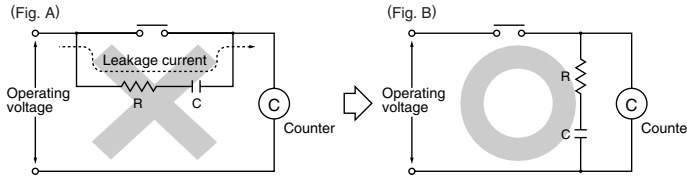

2) If the counter is directly switched with a non-contact element, leakage current may flow into the counter and cause it to malfunction.

Cautions for use (common for all models)

1. Terminal connections

Correctly connect the pins while seeing the terminal layout/wiring diagram. In particular, the DC type, which has polarities, does not operate with the polarities connected reverse. Any incorrect connection can cause abnormal heating or ignition.

2. Connection to operating voltage

1) Apply the entire supply voltage through a switch, relay or other contact.
2) The operating voltage for the DC type must be at the specified ripple percentage or less. The average voltage must fall within the allowable operating voltage range.

Rectification type	Ripple percentage
Single-phase, full-wave	Approx. 48%
Three-phase, full-wave	Approx. 4%
Three-phase, half-wave	Approx. 17%

3) Make sure that no induced voltage and residual voltage are applied between the power terminals on the counter after the power switch is turned OFF. (If the power line is wired in parallel with the high-voltage and motor lines, induced voltage may be produced between the power pins.)

3. Control output

1) Keep the load capacity below the counter's rated control capacity. If used above the rating, the counter's service life may shorten. With the transistor output type counters, transistors may be damaged.

4. Installing the counter

1) To install the counter, use the dedicated pin bracket or socket (cap). Avoid connecting the pins on the counter by directly soldering them.
2) In order to maintain the characteristics, do not remove the counter cover (case).

5. Superimposed surge of power supply

For the superimposed surge of power supply, the standard waveform ($\pm 1.2 \times 50\mu\text{s}$ or $\pm 1 \times 40\mu\text{s}$) is taken as the standard value for surge-proof voltage. (The positive and negative voltages are applied each three or five times between the power pins.)

For the standard values for the LC4H type counters, see the respective items in "Cautions for use."

• Single-pole, full-wave voltage for surge waveform [$\pm(1.2 \times 50) \mu\text{s}$]

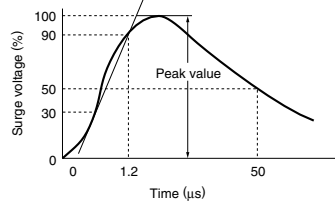

If external surge occurs exceeding the specified value, the internal circuit may break down. In this case, use a surge absorption element. The typical surge absorption elements include a varistor, a capacitor, and a diode. If a surge absorption element is used, use an oscilloscope to see whether or not the foreign surge exceeding the specified value appears.

6. Signal input

The counter's signal input comes in two ways. One is by opening and closing the input terminal. The other is by applying a specified H-level or L-level voltage to the input terminal.

For an input sensor's residual voltage, input impedance, input voltage level and other signal input conditions, see the ratings for each type of product.

7. Operating environment

1) For the ambient operating temperature and humidity, see the ratings for each type of product.
2) Avoid using the counter in a location where inflammable or corrosive gas is generated, the counter is exposed to much dust and other foreign matter; water or oil is splashed on the counter; or vibrations or shocks are given to the counter.

3) The counter cover (case), the knobs, and the dials are made of polycarbonated resin. Therefore, prevent the counter from being exposed to organic solvents such as methyl alcohol, benzene, and thinner, strong acid substances such as caustic soda, and ammonia and avoid using the counter in atmosphere containing any of those substances.

4) If the counter is used where noises are emitted frequently, separate the input signal elements (such as a sensor), the wiring for the input signal line, and the counter as far as possible from the noise source and the high power line containing noises.

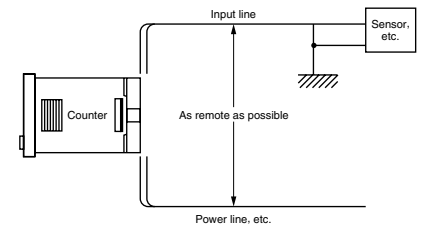

8. Checking the actual load

In order to increase the reliability in the actual use, check the quality of the counter in the actual usage.

9. Others

1) If the counter is used exceeding the ratings (operating voltage and control capacity), the contact life, or any other specified limit, abnormal heat, smoke, or ignition may occur.
2) The LC2H series counter, incorporates a lithium battery. Never disassemble the lithium battery or throw it into fire because this may affect humans and facilities. The lithium battery must be disposed of as an incom-bustible like other used batteries.
3) If any malfunction of the counter is likely to affect human life and properties, give allowance to the rated values and performance values. In addition, take appropriate safety measures such as a duplex circuit from the viewpoint of product liabilities.

DIN SIZE COUNTERS COMMON OPTIONS

Terminal sockets (Unit: mm inch, Tolerance: $\pm 1 \pm .039$)

Type	Appearance	Dimensions	Terminal wiring (Top view)	Mounting hole dimensions
LC4H LC4H-L (8-pin type)	<ul style="list-style-type: none"> • DIN rail socket (8-pin) 		<p>Note: Terminal No. on the main body are identical to those on the terminal socket.</p>	
LC4H LC4H-L LC4H-S LC4H-W (11-pin type)	<ul style="list-style-type: none"> • DIN rail socket (11-pin) 		<p>Note: Terminal No. on the main body are identical to those on the terminal socket.</p>	

Note: The terminal numbers on the counter are identical to those on the terminal socket.

Sockets (Unit: mm inch, Tolerance: $\pm 1 \pm .039$)

Type	Appearance	Dimensions	Terminal wiring (Top view)	Mounting hole dimensions
LC4H LC4H-L (8-pin type)	<ul style="list-style-type: none"> • Rear terminal socket 			—
	<ul style="list-style-type: none"> • 8P cap 			—
LC4H LC4H-L LC4H-S LC4H-W (11-pin type)	<ul style="list-style-type: none"> • Rear terminal socket 			—
	<ul style="list-style-type: none"> • 11P cap 			—

Note: The terminal numbers on the counter are identical to those on the socket.

DIN SIZE COUNTERS COMMON OPTIONS

Mounting parts

• Rubber gasket

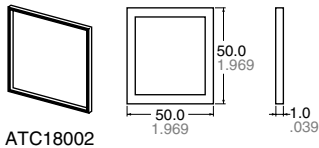

ATC18002

Applicable for LC4H series

The rubber gasket is enclosed in the LC4H series.

• Mounting frame

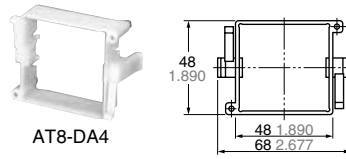

AT8-DA4

Applicable for LC4H series

• Mounting rails (Applicable for DIN and IEC standards)



AT8-DLA1
Length: 1 m
aluminum

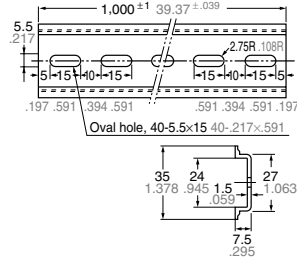

• Fastening plate



ATA4806

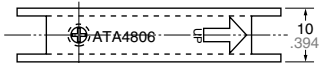
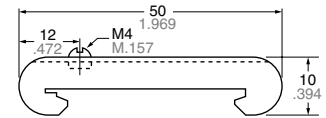

For holding DIN rails

• Protective cover for DIN 48 size

Flexible type

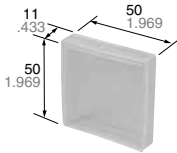

AQM4803

Accessories

• Panel cover (Black)

LC4H Panel cover (4 digits)



AEL58011

LC4H Panel cover (6 digits)

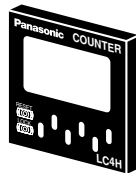

AEL58012

LC4H-S Panel cover (4 digits)



AEL58013

LC4H-S Panel cover (6 digits)



AEL58014

LC4H-W Panel cover

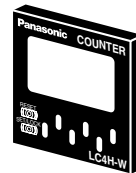

AEL68011

The black panel cover is also available so that you can change the appearance of the panel by changing the panel cover. The color of the standard panel cover is ash gray.

INSTALLING DIN SIZE COUNTER

Installation methods

1. Surface mount

1) For the counters of LC4H series, use the pin type counter.

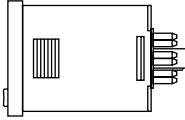

- 2) Put the terminal socket on the board directly or put it on the DIN rail (Fig. 1).
- 3) Insert the counter into the terminal socket and fix it with clip (Fig. 2)
- 4) On DIN rail mounting, mount the counter on the DIN rail tightly to get the proper dimension (Fig. 3).

(Fig. 1)

(Fig. 2)

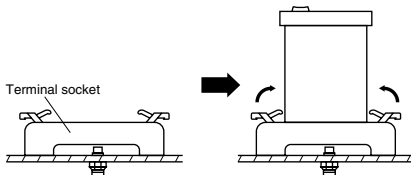

(Fig. 3)

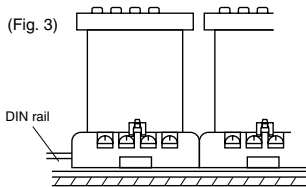

5) 8-pin type should be connected with terminal socket AT8-DF8K. 11-pin type should be connected with terminal socket AT8-DF11K.

6) DIN rail (AT8-DLA1) is also available (1 m).

2. Flush mount

1) For the counters of LC4H series, it is recommended to use the built-in screw terminal type for flush mount. (Mounting frame and rubber gasket are provided when counter is shipped.)

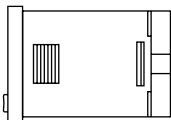

2) How to mount the counter
From the panel front, pass the counter through the square hole. Fit the mounting frame from the rear, and then push it in so that the clearance between the mounting frame and the panel surface is minimized. In addition, lock the mounting frame with a screw.

• LC4H series

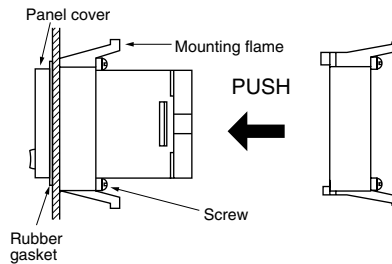

3) Caution in mounting the counter

• LC4H series

Ⓐ If the LC4H series are used as the waterproof types (IEC IP66), tighten the reinforcing screws on the mounting frames so that the counters, the rubber gaskets, and the panel surfaces are tightly contacted with each other. (Tighten the two screws with uniform force and make sure that there is no rattling. If the screws are tightened too excessively, the mounting frame may come off.)

Ⓑ If the counter is installed with the panel cover and the rubber gasket removed, the waterproofing characteristic is lost.

4) Removal

Loosen the screws on the mounting frame, spread the edge of frame and remove it.

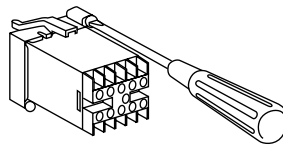

Pull the mounting frame backward while spreading out its hooks with your thumbs and index fingers.

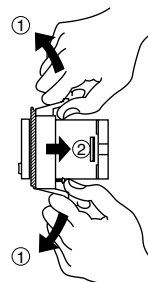

5) Correctly connect the terminals while seeing the terminal layout and wiring diagram.

6) If the pin type is used, the rear pin-bracket (AT8-RR) or the 8P cap (AD8-RC) is necessary to connect the pins. For the 11-pin type, use the 11P cap (AT8-DP11) and avoid directly soldering the round pins on the counter.

7) Panel cutout dimensions

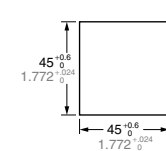

The standard panel cutout dimensions are shown in the left figure. (Panel thickness: 1 to 5 mm .039 to .197 inch)

8) Although the counters can be mounted adjacent to each other in this case, it is recommended to arrange the mounting holes as shown in the figure to facilitate attaching and detaching the mounting frame.

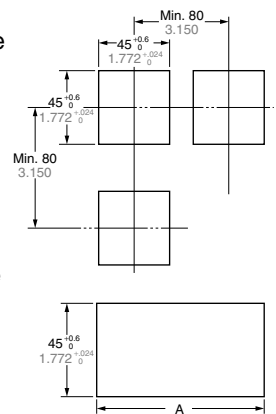

9) Adjacent mounting

Although the counters can be mounted adjacent to each other, remember that the panel surface of LC4H series counter will lose its water-resistant effect. (Panel thickness: 1 to 5 mm .039 to .197 inch)

$$A = (48 \times n - 2.5) +0.6 / -0.0$$





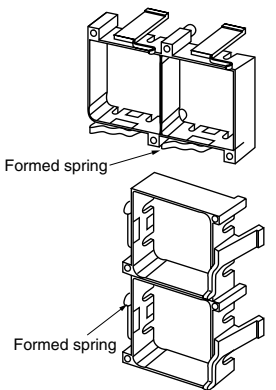





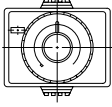



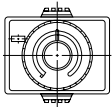













When lining up the counters horizontally, set the frames in such a position so the formed spring areas are at the top and bottom.

When lining up the counters vertically, set the frames in such a position as the formed spring areas are at the right and left.





























DISCONTINUED MODELS AND RECOMMENDED SUBSTITUTES















Timers













Discontinued models	Recommended substitutes	Attachment	Discontinued models	Recommended substitutes	Attachment
MHP-NS (Exposed type Square plug-in/ horizontal type) 	MHP-N (Exposed type Round plug-in/ vertical type) 	Terminal base AT8-RFD should be used.	CHP-NF (Exposed type Round plug-in/ vertical type) 	PM4H-F 	Attachment frame AT7821 should be used. * External dimensions, however, differ. In addition, the reset method changes from voltage input to non-voltage input.
MHP-NS-	MHP-N-		CHP-NF	PM4HF-	
MHP-M (Exposed type Round plug-in/ horizontal type) 	MHP-NM (Exposed type Round plug-in/ vertical type) 	Terminal base AT8-RFD should be used.	CHP-SD 	PM4H-SD 	With exposed attachment, terminal base ATC180041 should be used. * External dimensions and contact capacity, however, differ. In addition, with the PM4H-SD: 1) (1) to (8) have no internal connection, and 2) the input (star) changes to 1a.
MHP-M-	MHP-NM-		CHP-SD-	PM4HSD-	
MHP-YC (Embedded type With attachment frame) 	MHP-N (Exposed type Without attachment frame) 	Attachment frame AT7821 should be used.	PM48A 	PM4H-A 	With exposed attachment, terminal base ATC180041 should be used.
MHP-YC-	MHP-N-		PM48A-	PM4HA-	
MHP-YM (Embedded type With attachment frame) 	MHP-NM (Exposed type Without attachment frame) 	Attachment frame AT7831 should be used.	PM48 	PM4H-S 	With exposed attachment, terminal base ATC180031 should be used.
MHP-YM-	MHP-NM-		PM48	PM4HS-	
CHP-N (Exposed type with attachment frame type) 	PM4H-S PMH 	The external dimension and contact capacity are different.	PM48M 	PM4H-M 	With exposed attachment, terminal base ATC180031 for F8 type and F8R type ATC180041 for F11R type.
CHP-N-	PM4HS- PMH-		PM48M-	PM4HM-	
CHP-N (Exposed type without attachment frame type) 	PM4H-S PMH 	The external dimension and contact capacity are different.	PM48F 	PM4H-F 	With exposed attachment, terminal base ATC180031 for F8 type and F8R type ATC180041 for F11R type.
CHP-N-	PM4HS- PMH-		PM48F-	PM4HF-	
CHP-NF (Exposed type without attachment frame type) 	PM4H-F 	* External dimensions, however, differ. In addition, the reset method changes from voltage input to non-voltage input.	PM48SD 	PM4H-SD 	With exposed attachment, terminal base ATC180031 should be used.
CHP-NF-	PM4HF-		PM48SD	PM4HSD	

Timers

Discontinued models	Recommended substitutes	Attachment	Discontinued models	Recommended substitutes	Attachment
PM48W 	PM4H-W 	With exposed attachment, terminal base ATC180031 should be used.	LT48 (8-pin) 	LT4H (8-pin) 	
PM48W PMH-M 	PM4H-W- PM4H-M/PM4S 	The external dimension and contact capacity are different.	LT48 LT48W (8-pin) 	LT4H LT4H-L LT4H-W (8-pin) 	
PMH-M- CDX Time relay 	PM4HM-/PM4S- S1DXM-A Timer/ S1DX Timer 		LT48W LT48W (8-pin) 	LT4HW LT4H-W (8-pin) 	
CDX PDX Timer 	S1DXM-/S1DX- S1DXM-A Timer/ S1DX Timer 		DIN rail socket (8-pin) 	DIN rail socket (8-pin) 	
PDX VHP digital high-power timer 	S1DXM-/S1DX- QM4H digital timer 	The size is different. Compact size ↓ DIN48	ATC18003 DIN rail socket (11-pin) 	ATC180031 DIN rail socket (11-pin) 	
VHP QM48S (8-pin) 	QM4H QM4H (8-pin) 		ATC18004 QM48S 	ATC180041 QM4H (8-pin) 	
QM48S QM72S (Screw terminal) 	QM4H QM4H (8-pin) 	The size is different. □72 ↓ □48			
QM72S	QM4H				

In some cases, the specifications of the recommended substitutes are not exactly the same as those of the discontinued model. Please confirm the specifications before using the recommended substitutes.

Counters		
Discontinued models	Recommended substitutes	Attachment
MC electromagnetic counters  MC6	LC4H  LC4H LC4H-L	The size and attachment method are different. The input method is different. (Voltage input → non-voltage input)
LC48 (Relay type: 8-pin Tr type: 11-pin)  LC48	LC4H (Relay type: 8-pin Tr type: 11-pin)  LC4H LC4H-L	
LC48W (11-pin)  LC48W	LC4H-W (11-pin)  LC4H-W	
EM48S (8-pin)  EM48S	LC4H (8-pin)  LC4H LC4H-L	
EM72S (Screw terminal)  EM72S	LC4H (Screw terminal)  LC4H LC4H-L	The size is different. <input type="checkbox"/> 72 ↓ <input type="checkbox"/> 48
LC24 Panel-mounting type  <ul style="list-style-type: none"> One-touch installation type LC24 	LC2H Panel-mounting type   <ul style="list-style-type: none"> One-touch installation type Installation frame type LC2H 	The both one-touch installation type and installation frame type are available.
LC24 PC board mounting type  LC24	LC2H PC board mounting type  LC2H	

Hour meters		
Discontinued models	Recommended substitutes	Attachment
 TH11* TH12*	 TH141S TH142S	Body Round type (attachment hole ϕ 45) ↓ Square type (attachment hole \square 45)
 TH21* TH22*	 TH241S TH242S	Body Square type (attachment hole \square 47) ↓ Square type (attachment hole \square 45)
TH30  TH30	LT4H (~999.9 h)  LT4H LT4H-W (~9999 h)  LT4HW	The size and attachment method are different. The input method is different. (Voltage input → non-voltage input)
LH24 Panel-mounting type  <ul style="list-style-type: none"> One-touch installation type LH24 	LH2H Panel-mounting type   <ul style="list-style-type: none"> One-touch installation type Installation frame type LH2H 	The both one-touch installation type and installation frame type are available.
LH24 PC board mounting type  LH24	LH2H PC board mounting type  LH2H	

In some cases, the specifications of the recommended substitutes are not exactly the same as those of the discontinued model. Please confirm the specifications before using the recommended substitutes.

FOREIGN SPECIFICATIONS OVERVIEW

1. International Standards

IEC standard

International Electrotechnical Commission

By promoting international cooperation toward all problems and related issues regarding standardization in the electrical and electronic technology fields, the IEC, a non-governmental organization, was started in October, 1908, for the purpose of realizing mutual understanding on an international level. To this end, the IEC standard was enacted for the purpose of promoting international standardization.

2. North America

UL (Underwriters Laboratories Inc.)

This is a non-profit testing organization formed in 1894 by a coalition of U.S. fire insurance firms, which tests and approves industrial products (finished products). When electrical products are marketed in the U.S., UL approval is mandated in many states, by state law and city ordinances. In order to obtain UL approval, the principal parts contained in industrial products must also be UL-approved parts.

UL approval is divided into two general types. One is called "listing" (Fig. 1), and applies to industrial products (finished products). Under this type of approval, products must be approved unconditionally. The other type is called "recognition" (Fig. 2), and is a conditional approval which applies to parts and materials.

CSA (Canadian Standards Association)

This was established in 1919 as a non-profit, non-governmental organization aimed at promoting standards. It sets standards for industrial products, parts, and materials, and has the authority to judge electrical products to determine whether they conform to those standards. The CSA is the ultimate authority in the eyes of both the government and the people in terms of credibility and respect. Almost all states and provinces in Canada require CSA approval by law, in order to sell electrical products. As a result, electrical products exported from Japan to Canada are not approved under Canadian laws unless they have received CSA approval and display the CSA mark. Approval is called "certification", and products and parts which have been approved are called "certified equipment", and display the mark shown in Fig. 3. The mark shown in Fig. 4 is called the "Component Acceptance" mark, and indicates conditional approval which is applicable to parts. The C-UL mark shown in Fig. 5 (finished products) and Fig. 6 (parts) indicates that the product has been tested and approved in UL laboratories, based on UL and CSA standards, through mutual approval activities.

LISTING MARK



Fig. 1

RECOGNITION MARK



Fig. 2

Certification



Fig. 3

Component Acceptance



Fig. 4



Fig. 5



Fig. 6

3. Europe

EN standard

European Standards/Norme Europeennee (France)/Europaishe Norm (Germany)

Abbreviation for European Standards. A unified standard enacted by CEN/CENELEC (European Standards Committee/European Electrical Standards Committee). EU and EFTA member nations employ the content of the EN standards into their own national standards and are obligated to abolish those national standards that do not agree with the EN standards.

(1) Germany



VDE (Verband Deutscher Elektrotechniker)

The VDE laboratory was established mainly by the German Electric Technology Alliance, which was formed in 1893. It carries out safety experiments and passes approval for electrical devices and parts. Although VDE certification is not enforced under German law, punishment is severe should electrical shock or fire occur; therefore, it is, in fact, like an enforcement.



TÜV (Technischer Überwachungs-Verein)

TÜV is a civilian, non-profit, independent organization that has its roots in the German Boiler Surveillance Association, which was started in 1875 for the purpose of preventing boiler accidents. A major characteristic of TÜV is that it exists as a combination of 14 independent organizations (TÜV Rheinland, TÜV Bayern, etc.) throughout Germany. TÜV carries out inspection on a wide variety of industrial devices and equipment, and has been entrusted to handle electrical products, as well, by the government. TÜV inspection and certification is based mainly on the VDE standard. TÜV certification can be obtained from any of the 14 TÜVs throughout Germany and has the same effectiveness as obtaining VDE certification.

4. Shipping Standards

(1) Lloyd's Register of Shipping



Standards from the Lloyd's Register shipping association based in England. These standards are safety standards for environmental testing of the temperature and vibration tolerances of electrical components used for UMS (unmanned machine rooms in marine vessels) applications. These standards have become international standards for control equipment in all marine vessel applications. No particular action is taken to display the conformation to these standards on the products.

5. Pilot Duty

One of the specifications in the “UL508 Industrial Control Equipment” regulations at UL (Underwriters Laboratories Inc.), has to do with the grade of contact control capacity by NEMA (National Electrical Manufacturers Association) standards. By obtaining both UL and CSA approval for this grade, the product becomes authorized publicly.

Pilot Duty A300

AC applied voltage [V]	Electrification current [A]	Input power [A]	Breaker power [A]	[VA]	
				During input	During breaker
120	10	60	6	7,200	720
240		30	3	7,200	720

Pilot Duty B300

AC applied voltage [V]	Electrification current [A]	Input power [A]	Breaker power [A]	[VA]	
				During input	During breaker
120	5	30	3	3,600	360
240		15	1.5	3,600	360

Pilot Duty C300

AC applied voltage [V]	Electrification current [A]	Input power [A]	Breaker power [A]	[VA]	
				During input	During breaker
120	2.5	15	1.5	1,800	180
240		7.5	0.7	1,800	180

FOREIGN SPECIFICATIONS

TIMER

Products Name	Recognized by UL Standards		Certified by CSA Standards		Lloyd's Register Standards		Remarks	
	File No.	Recognized rating	File No.	Certified rating	File No.	Certified rating		
PM4S	E43149	5A250VAC PILOT DUTY C300	E43149 (C-UL)	5A250VAC PILOT DUTY C300	—	—		
PM4H-A PM4H-S PM4H-M PM4H-SD PM4H-W	E122222	5A250VAC PILOT DUTY C300	LR39291	5A250VAC PILOT DUTY C300	98/10004	5A 250V AC (resistive)		
PM4H-F	E122222	3A250VAC PILOT DUTY C300	LR39291	3A250VAC PILOT DUTY C300	98/10004	3A 250V AC (resistive)		
LT4H LT4H-L LT4H-W	E122222	5A250VAC PILOT DUTY C300 100mA30VDC	E122222 (C-UL)	5A250VAC PILOT DUTY C300 100mA30VDC	—	—		
QM4H	E43149	5A250VAC PILOT DUTY C300	E43149 (C-UL)	5A250VAC PILOT DUTY C300	—	—		
PMH	E59504	7A1/6HP125VAC 7A1/6HP250VAC 3A30VDC PILOT DUTY C300	LR39291	7A1/6HP125VAC 7A1/6HP250VAC 3A30VDC PILOT DUTY C300	88/10123	125V3.5A (COS $\phi \approx 0.4$) 250V2A (COS $\phi \approx 0.4$) 250V7A (COS $\phi \approx 1.0$)	"The standard models conform to the UL/CSA standard. (To place an order, you do not need to specify the tailing character [9] of each item number.)" The standard models conform to the LLOYD standard.	
MHP MHP-M	E59504	5A250VAC	LR39291	5A250VAC	88/10123	250V5A (COS $\phi \approx 1.0$)	"The standard models conform to the UL/CSA standard. (To place an order, you do not need to specify the tailing character [9] of each item number.)"	
S1DXM-A/M (Relay output)	2C	E122222	7A125VAC 6A250VAC 1/6HP125, 250VAC PILOT DUTY C300	LR39291	7A125VAC 6A250VAC 1/6HP125, 250VAC PILOT DUTY C300	98/10004	7A 250V AC (resistive)	
	4C	E122222	5A250VAC 1/10HP125, 250VAC PILOT DUTY C300	LR39291	5A250VAC 1/10HP125, 250VAC PILOT DUTY C300	98/10004	5A 250V AC (resistive)	
S1DX (Relay output)	2C	E122222	7A125VAC 6A250VAC 1/6HP125, 250VAC PILOT DUTY C300	LR39291	7A125VAC 6A250VAC 1/6HP125, 250VAC PILOT DUTY C300	98/10004	7A 250V AC (resistive)	
	4C	E122222	5A250VAC 1/10HP125, 250VAC PILOT DUTY C300	LR39291	5A250VAC 1/10HP125, 250VAC PILOT DUTY C300	98/10004	5A 250V AC (resistive)	
PM5S-A PM5S-S PM5S-M	E59504 (C-UL)	5A250VAC PILOT DUTY C300	E59504 (C-UL)	5A250VAC PILOT DUTY C300	—	—		

Accessories

Products Name	Recognized by UL Standards		Certified by CSA Standards		Lloyd's Register Standards		Remarks
	File No.	Recognized rating	File No.	Certified rating	File No.	Certified rating	
Common mounting tracks for timers	E59504	10A250VAC AT8-RFD (AT78039) 7A250VAC AT8-DF8L (ATA48211) 8P cap was an approved as an option. AD8-RC (AD8013)	LR39291	10A250VAC AT8-RFD (AT78039) 7A250VAC AT8-DF8L (ATA48211) 8P cap was an approved as an option. AD8-RC (AD8013)	—	—	
	E148103	AT8-DF8K (ATC180031) AT8-DF11K (ATC180041) AT8-R8K (AT78041) AT8-R11K (AT78051)	E148103 (C-UL)	AT8-DF8K (ATC180031) AT8-DF11K (ATC180041) AT8-R8K (AT78041) AT8-R11K (AT78051)	—	—	

FOREIGN SPECIFICATIONS

Counters

Product name	UL recognized		CSA certified		Remarks
	File No.	Approved ratings	File No.	Approved ratings	
LC4H LC4H-L LC4H-S	E122222	5A250V AC PILOT DUTY C300 100mA 30V DC	E122222 (C-UL)	5A250V AC PILOT DUTY C300 100mA 30V DC	
LC4H-W	E122222	3A250V AC PILOT DUTY C300 100mA 30V DC	E122222 (C-UL)	3A250V AC PILOT DUTY C300 100mA 30V DC	
LC2H	E122222	24-240 V AC/DC 4.5-30 V DC 3 V DC	E122222 (C-UL)	24-240 V AC/DC 4.5-30 V DC 3 V DC	
LC2H preset	E122222	24-240 V AC/DC 4.5-30 V DC 3 V DC	E122222 (C-UL)	24-240 V AC/DC 4.5-30 V DC 3 V DC	

Hour Meters

Product name	UL recognized		CSA certified		Remarks
	File No.	Approved ratings	File No.	Approved ratings	
TH13 · TH23 series	E42876	115-120, 220, 240V AC	LR39291	115-120, 220, 240V AC	• For UL-recognized and CSA-certified products, specify "U" at the end of the part No.
TH14 · TH24 series	E42876	12, 24, 48, 100, 110, 115-120, 200, 220, 240V AC	LR39291	12, 24, 48, 100, 110, 115-120, 200, 220, 240V AC	• Only black panel-mounting type UL-recognized and CSA-certified. • For UL-recognized and CSA-certified products, specify "U" at the end of the product code. • Panel-mounting silver type not UL-recognized nor CSA-certified.
TH63 · 64 series	E42876	12, 24, 48, 100, 110, 115-120, 200, 220, 240V AC	LR39291	12, 24, 48, 100, 110, 115-120, 200, 220, 240V AC	• Standard products are UL-recognized and CSA-certified.
LH2H	E122222	24-240 V AC/DC 4.5-30 V DC 3 V DC	E122222 (C-UL)	24-240 V AC/DC 4.5-30 V DC 3 V DC	• Standard products are UL-recognized and CSA-certified.
LH2H preset	E122222	24-240 V AC/DC 4.5-30 V DC 3 V DC	E122222 (C-UL)	24-240 V AC/DC 4.5-30 V DC 3 V DC	• Standard products are UL-recognized and CSA-certified.
TH8 series	E42876	12 V DC 24 V DC	E42876 (C-UL)	12 V DC 24 V DC	• Standard products are UL-recognized and CSA-certified.

Accessories

Product name	UL-recognized		CSA certified		Remarks
	File No.	Rating	File No.	Rating	
Common counter fixtures	E59504	10A250V AC AT8-RFD (AT78039) 7A250V AC AT8-DF8L (ATA48211) 8P cap CSA-certified as option. AD8-RC (AD8013)	LR26550	10A250V AC AT8-RFD (AT78039) 7A250V AC AT8-DF8L (ATA48211) 8P cap UL-listed as option. AD8-RC(AD8013)	
	E148103	AT8-DF8K (ATC180031) AT8-DF11K (ATC180041) AT8-R8K (AT78041) AT8- R11K (AT78051)	E148103 (C-UL)	AT8-DF8K (ATC180031) AT8-DF11K (ATC180041) AT8-R8K (AT78041) AT8- R11K (AT78051)	

CE MARKINGS OVERVIEW

Counter, Hour Meter conforming to EN/IEC standards

The Timer, Counter, Hour Meter shown below conform to both EN and IEC standards, and may display the CE markings.

Product classification	Product name	EMC directives	Low-voltage directives
Timers	LT4H	EN 61000-6-4/EN 61000-6-2	EN 61812-1
	LT4H-L	EN 61000-6-4/EN 61000-6-2	EN 61812-1
	LT4H-W	EN 61000-6-4/EN 61000-6-2	EN 61812-1
	PM4H	EN 61000-6-4/EN 61000-6-2	EN 61812-1
	S1DX	EN 61000-6-4/EN 61000-6-2	EN 61812-1
	S1DXM-A/M	EN 61000-6-4/EN 61000-6-2	EN 61812-1
	PM4S	EN 61000-6-4/EN 61000-6-2	EN 61812-1
	PM5S	EN 61000-6-4/EN 61000-6-2	EN 61812-1
	QM4H	EN 61000-6-4/EN 61000-6-2	EN 61010-1
Time Switch	A-TB72	EN 61000-6-4/EN 61000-6-2	EN 61812-1
	A-TB72Q	EN 61000-6-4/EN 61000-6-2	EN 61812-1
Counters	LC4H	EN 61000-6-4/EN 61000-6-2	EN 61812-1
	LC4H-L	EN 61000-6-4/EN 61000-6-2	EN 61812-1
	LC4H-S	EN 61000-6-4/EN 61000-6-2	EN 61812-1
	LC4H-W	EN 61000-6-4/EN 61000-6-2	EN 61812-1
	LC2H	EN 61000-6-4/EN 61000-6-2	EN 61010-1
	LC2H preset	EN 61000-6-4/EN 61000-6-2	—
Hour Meters	TH13	EN 61000-6-4/EN 61000-6-2	EN 61010-1
	TH23	EN 61000-6-4/EN 61000-6-2	EN 61010-1
	TH14	EN 61000-6-4/EN 61000-6-2	EN 61010-1
	TH24	EN 61000-6-4/EN 61000-6-2	EN 61010-1
	TH40	EN 61000-6-4/EN 61000-6-2	EN 61010-1
	TH50	EN 61000-6-4/EN 61000-6-2	EN 61010-1
	TH63	EN 61000-6-4/EN 61000-6-2	EN 61010-1
	TH64	EN 61000-6-4/EN 61000-6-2	EN 61010-1
	LH2H	EN 61000-6-4/EN 61000-6-2	EN 61010-1
	LH2H preset	EN 61000-6-4/EN 61000-6-2	—
	TH8	EN 61000-6-4/EN 61000-6-2	—

What are EN standards?

An abbreviation of Norme Europeenne (in French), and called European Standards in English. Approval is by vote among the CEN/CENELEC member countries, and is a unified standards limited to EU member countries, but the contents conform to the international ISO/IEC standards.

If the relevant EN standard does not exist, it is necessary to obtain approval based on the relevant IEC standard or, if the relevant IEC standard does not exist, the relevant standard from each country, such as VDE, BS, SEMKO, and so forth.

CE markings and EC directives

The world's largest single market, the European Community (EC) was born on 1 January 1993 (changing its name to EU in November 1993. It is now always expressed as EU, apart from EC directives.) EU member country products have always had their quality and safety guaranteed according to the individual standards of each member country. However, the standards of each country being different prevented the free flow of goods within the EU. For this reason, in order to eliminate non-tariff barriers due to these standards, and to maximize the merits of EU unification, the EC directives were issued concomitant to the birth of the EU.

The EN standards were established as universal EU standards in order to facilitate EU directives. These standards were merged with the international IEC standards and henceforth reflect the standards in all countries. Also, the CE markings show that products conform to EC directives, and guarantee the free flow of products within the EC.

Appropriate EC directives for control equipment products

The main EC directives that are to do with machinery and electrical equipment are the machinery directive, the EMC directive, the low voltage directive, and the telecom directive. Although these directives have already been issued, the date of their enactment is different for each one. The machinery directive was 1 January 1995. The EMC directive was 1 January 1996, and the low voltage directive was enacted from 1 January 1997. The telecom directive was established by the separate CTR (Common Technology References.)