

# NCP583

## Ultra-Low Iq 150 mA CMOS LDO Regulator with Enable

The NCP583 series of low dropout regulators are designed for portable battery powered applications which require precise output voltage accuracy and low quiescent current. These devices feature an enable function which lowers current consumption significantly and are offered in two small packages; SC-82AB and the SOT-563.

A 1.0  $\mu$ F ceramic capacitor is the recommended value to be used with these devices on the output pin.

### Features

- Ultra-Low Dropout Voltage of 250 mV at 150 mA
- Excellent Line Regulation of 0.05%/V
- Excellent Load Regulation of 20 mV
- High Output Voltage Accuracy of  $\pm 2\%$
- Ultra-Low Iq Current of 1.0  $\mu$ A
- Very Low Shutdown Current of 0.1  $\mu$ A
- Wide Output Voltage Range of 1.5 V to 3.3 V
- Low Temperature Drift Coefficient on the Output Voltage of  $\pm 100$  ppm/ $^{\circ}$ C
- Fold Back Protection Circuit
- Input Voltage up to 6.5 V
- These are Pb-Free Devices

### Typical Applications

- Portable Equipment
- Hand-Held Instrumentation
- Camcorders and Cameras

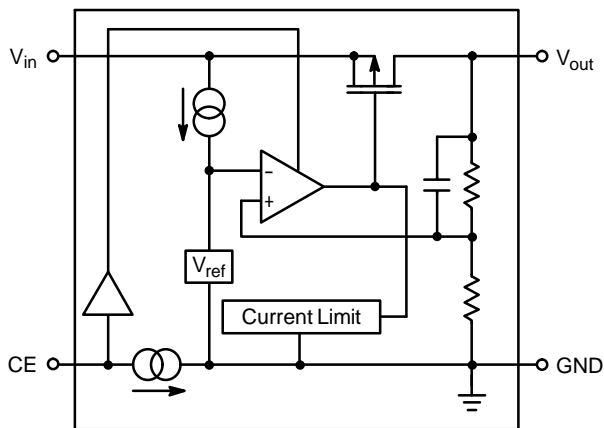

Figure 1. Simplified Block Diagram



ON Semiconductor®

[www.onsemi.com](http://www.onsemi.com)

### MARKING DIAGRAMS

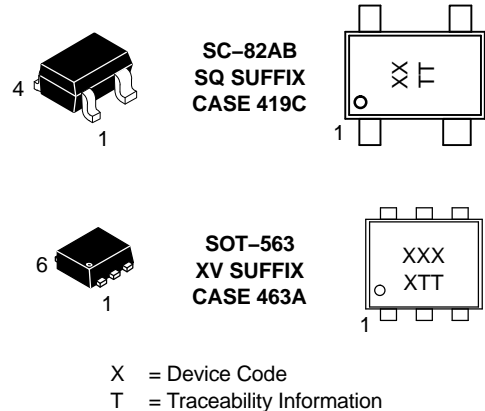

### ORDERING INFORMATION

See detailed ordering and shipping information in the package dimensions section on page 8 of this data sheet.

# NCP583

## PIN FUNCTION DESCRIPTION

SOT-563 Pin	SC-82AB Pin	Symbol	Description
1	4	$V_{in}$	Power supply input voltage.
2	2	GND	Power supply ground.
3	3	$V_{out}$	Regulated output voltage.
4	–	NC	No connect.
5	–	GND	Power supply ground.
6	1	CE	Chip enable pin.

## MAXIMUM RATINGS

Rating	Symbol	Value	Unit
Input Voltage	$V_{in}$	6.5	V
Input Voltage (CE Pin)	$V_{CE}$	6.5	V
Output Voltage	$V_{out}$	-0.3 to $V_{in} + 0.3$	V
Output Current	$I_{out}$	180	mA
Thermal Junction Resistance SC-82AB SOT-563	$R_{\theta JA}$	263 200	°C/W
ESD Capability, Human Body Model, C = 100 pF, R = 1.5 k $\Omega$	$ESD_{HBM}$	2000	V
ESD Capability, Machine Model, C = 200 pF, R = 0 $\Omega$	$ESD_{MM}$	200	V
Operating Ambient Temperature Range	$T_A$	-40 to +85	°C
Maximum Junction Temperature	$T_{J(max)}$	125	°C
Storage Temperature Range	$T_{stg}$	-55 to +150	°C

Stresses exceeding those listed in the Maximum Ratings table may damage the device. If any of these limits are exceeded, device functionality should not be assumed, damage may occur and reliability may be affected.

## ELECTRICAL CHARACTERISTICS ( $V_{in} = V_{out} + 1.0$ V, $T_A = -40^{\circ}\text{C}$ to $+85^{\circ}\text{C}$ , unless otherwise noted.)

Characteristic	Symbol	Min	Typ	Max	Unit
Input Voltage	$V_{in}$	1.7	–	6.0	V
Output Voltage ( $1.0 \mu\text{A} \leq I_{out} \leq 30$ mA)	$V_{out}$	$V_{out} \times 0.98$	–	$V_{out} \times 1.02$	V
Line Regulation ( $I_{out} = 30$ mA) ( $V_{out} + 0.5$ V $\leq V_{in} \leq 6.0$ V)	$Reg_{line}$	–	0.05	0.20	%/V
Load Regulation ( $1.0 \mu\text{A} \leq I_{out} \leq 150$ mA)	$Reg_{load}$	–	20	40	mV
Dropout Voltage ( $I_{out} = 150$ mA) $V_{out} = 1.5$ V $1.7$ V $\leq V_{out} \leq 1.9$ V $2.1$ V $\leq V_{out} \leq 2.7$ V $2.8$ V $\leq V_{out} \leq 3.3$ V	$V_{DO}$	–	0.60 0.50 0.35 0.25	0.90 0.75 0.55 0.40	V
Quiescent Current ( $I_{out} = 0$ mA)	$I_q$	–	1.0	1.5	$\mu\text{A}$
Output Current	$I_{out}$	150	–	–	mA
Shutdown Current ( $V_{CE} = \text{Gnd}$ )	$I_{SD}$	–	0.1	1.0	$\mu\text{A}$
Output Short Circuit Current ( $V_{out} = 0$ )	$I_{lim}$	–	40	–	mA
Enable Input Threshold Voltage – High – Low	$V_{th_{enh}}$ $V_{th_{enl}}$	1.2 0	– –	6.0 0.3	V
Output Voltage Temperature Coefficient ( $I_{out} = 30$ mA, $-40^{\circ}\text{C} \leq T_A \leq 85^{\circ}\text{C}$ )	$\Delta V_{out}/\Delta T$	–	$\pm 100$	–	ppm/°C

TYPICAL CHARACTERISTICS

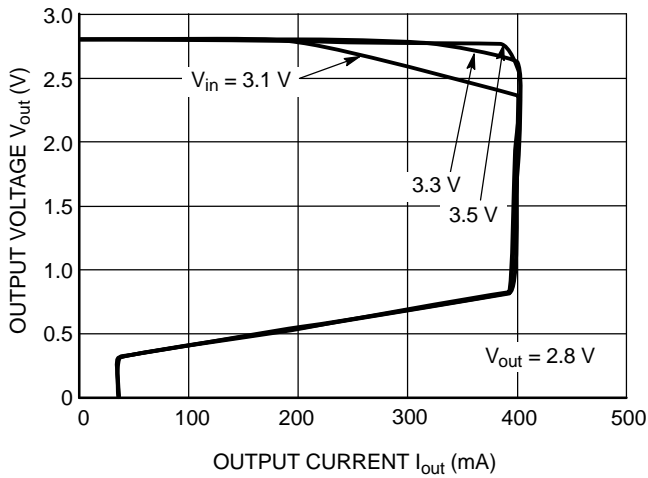

Figure 2. Output Voltage vs. Output Current

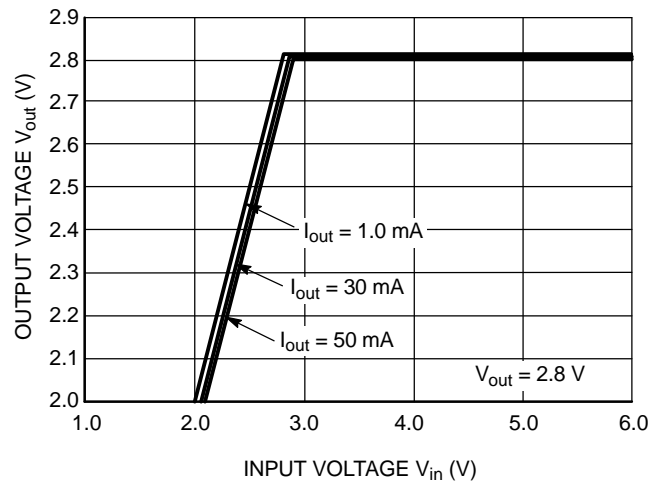

Figure 3. Output Voltage vs. Input Voltage

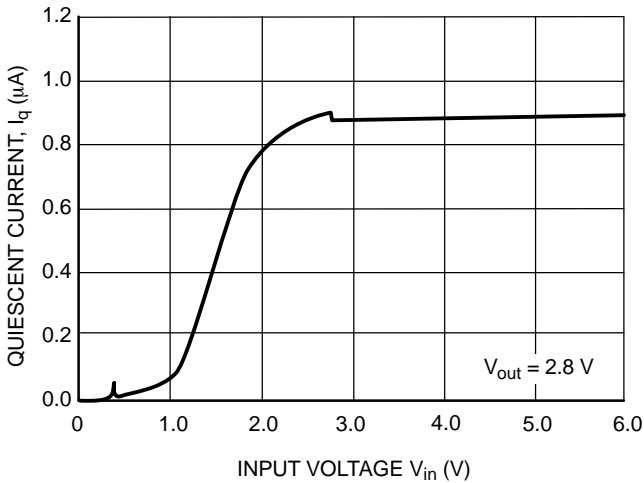

Figure 4. Quiescent Current vs. Input Voltage

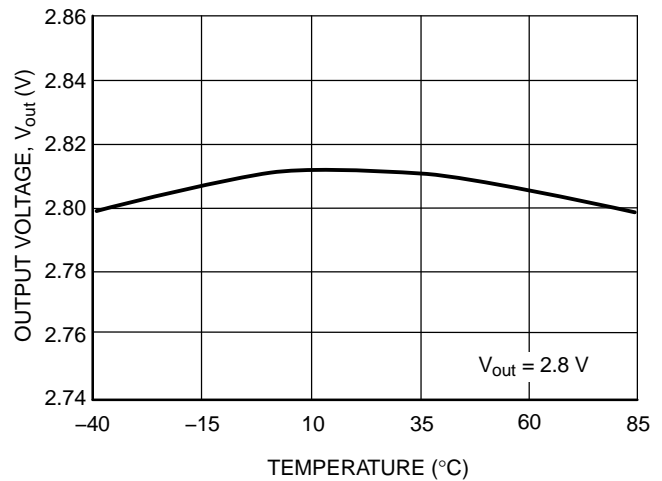

Figure 5. Output Voltage vs. Temperature

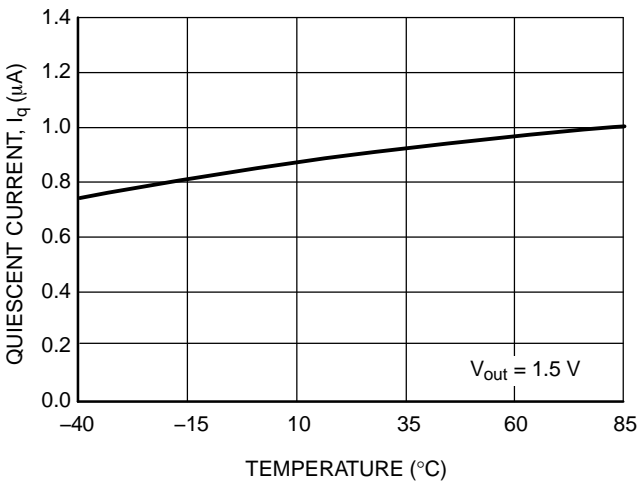

Figure 6. Quiescent Current vs. Temperature

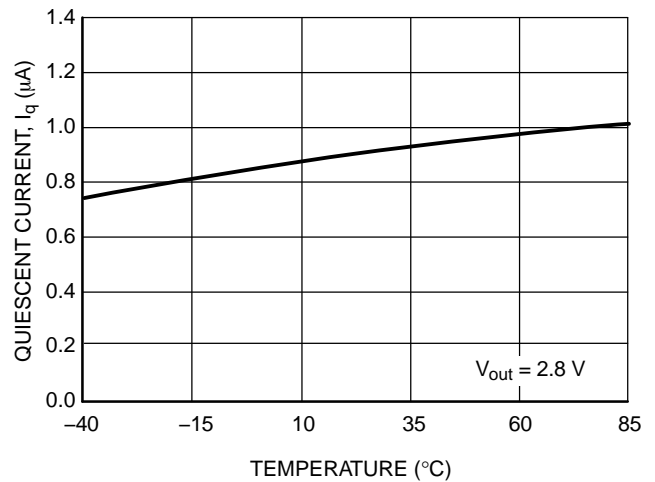

Figure 7. Quiescent Current vs. Temperature

# NCP583

## TYPICAL CHARACTERISTICS

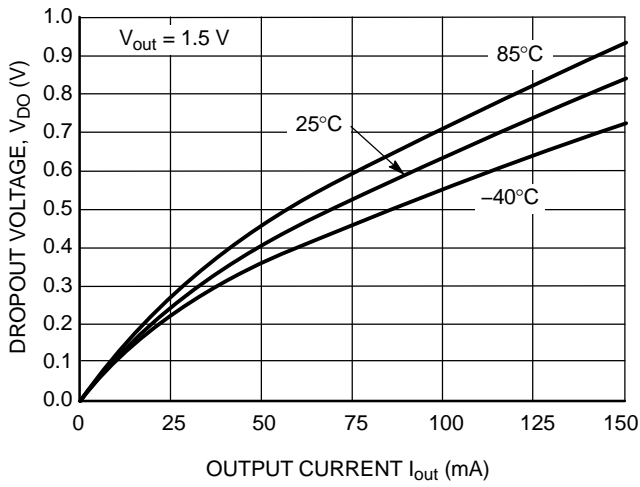

Figure 8. Dropout Voltage vs. Output Current

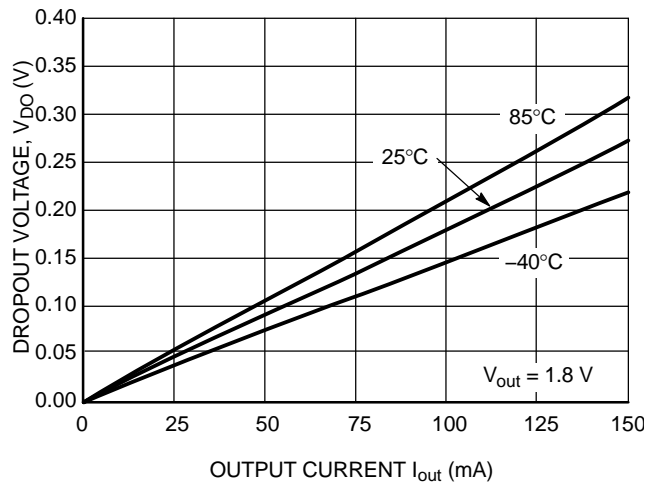

Figure 9. Dropout Voltage vs. Output Current

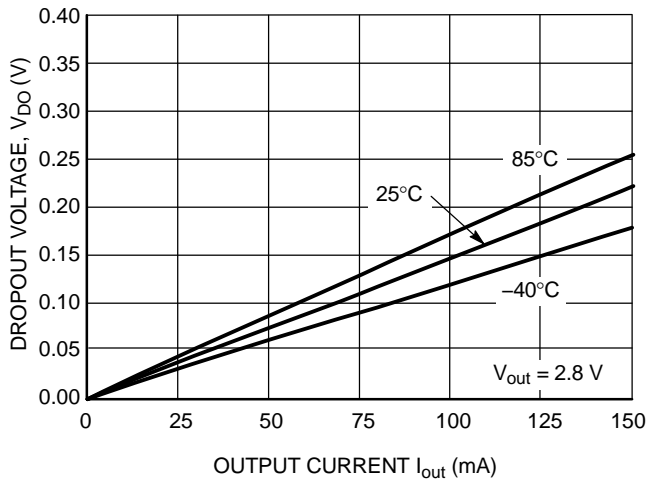

Figure 10. Dropout Voltage vs. Output Current

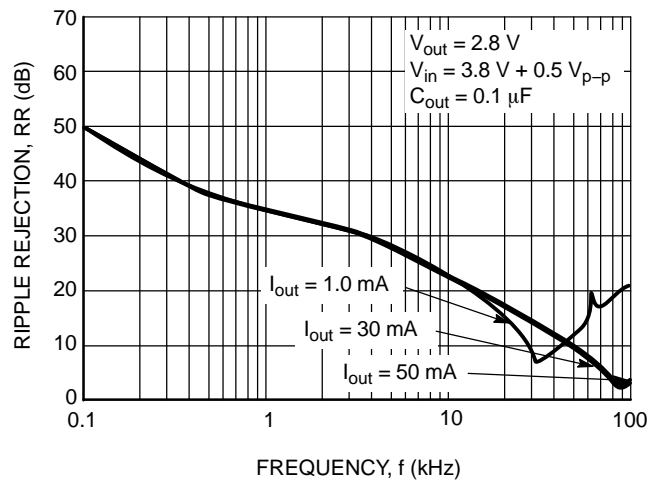

Figure 11. Ripple Rejection vs. Frequency

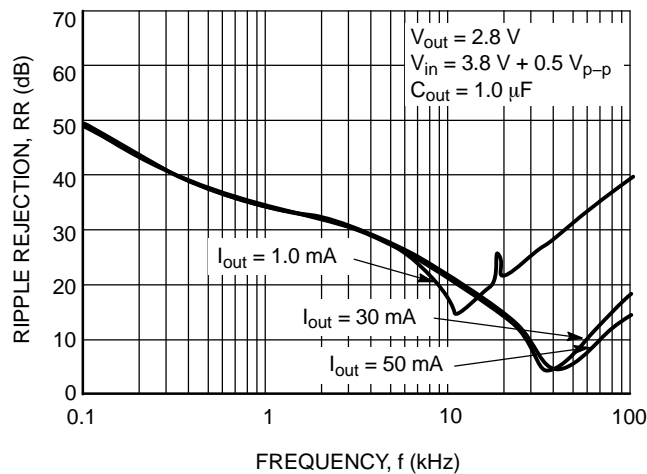
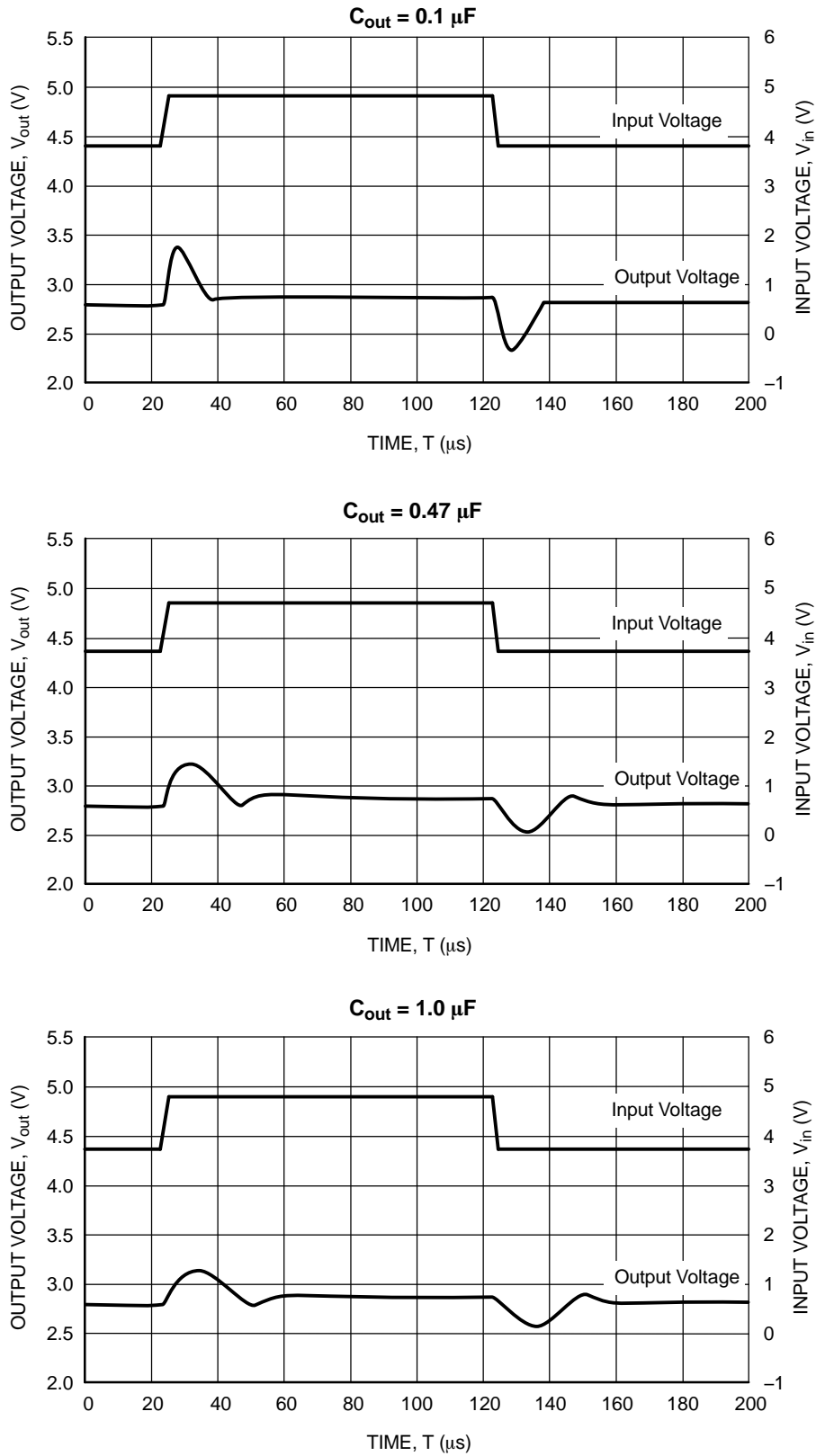

Figure 12. Ripple Rejection vs. Frequency

# NCP583

## TYPICAL CHARACTERISTICS



**Figure 13. Input Transient Response**  
( $V_{out} = 2.8 V$ ,  $I_{out} = 30 mA$ ,  $t_r = t_f = 5.0 \mu s$ ,  $C_{in} = 0$ )

# NCP583

## TYPICAL CHARACTERISTICS

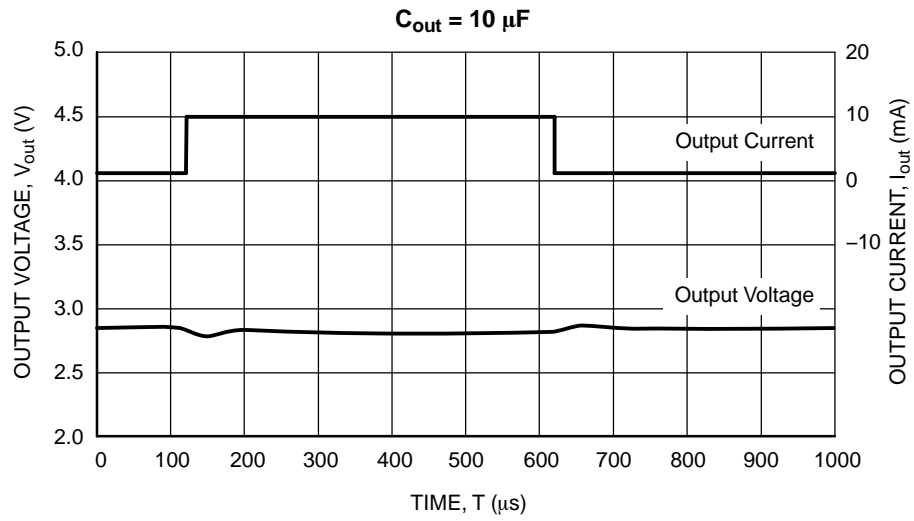
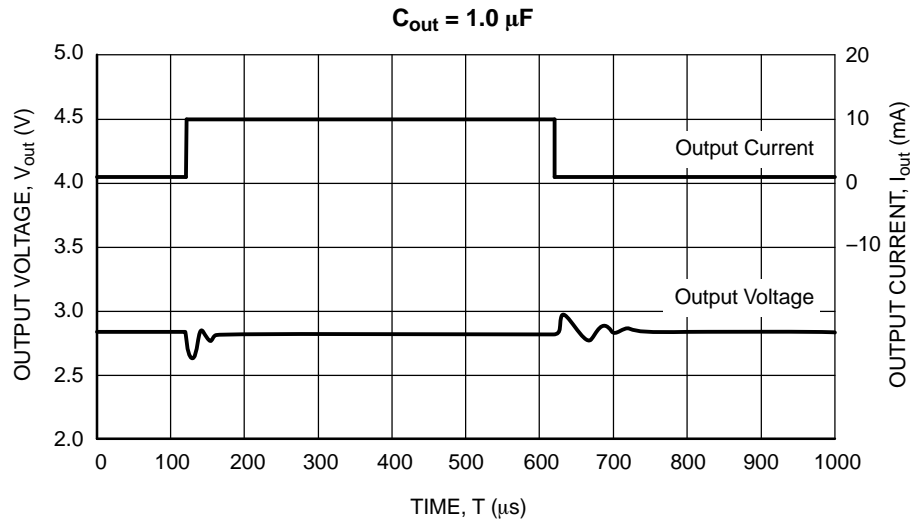

**Figure 14. Load Transient Response**  
( $V_{out} = 2.8$  V,  $t_r = t_f = 5.0 \mu s$ ,  $V_{in} = 3.8$  V)

# NCP583

## TYPICAL CHARACTERISTICS

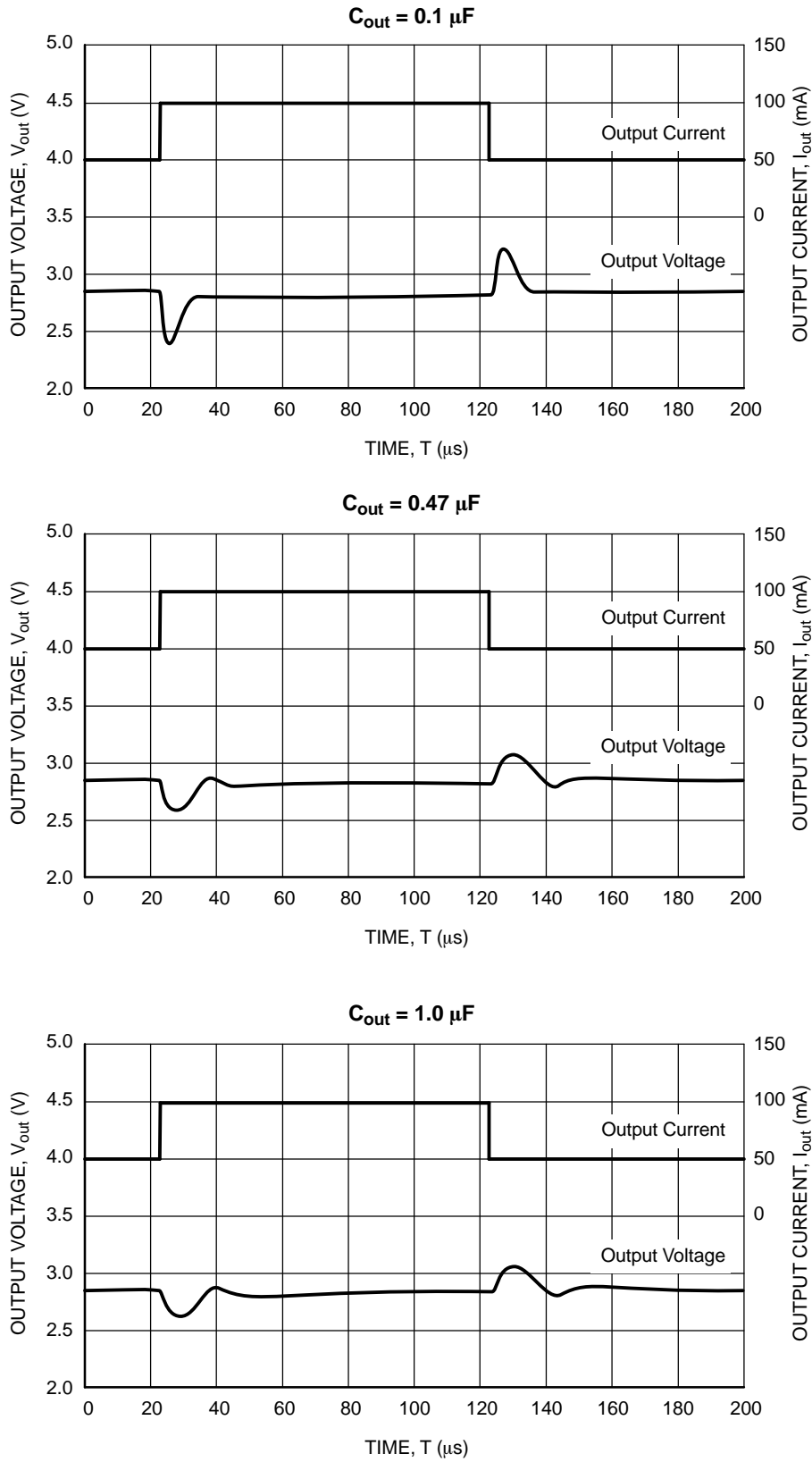

**Figure 15. Load Transient Response**  
( $V_{out} = 2.8 V$ ,  $t_r = t_f = 5.0 \mu s$ ,  $V_{in} = 3.8 V$ )

# NCP583

## APPLICATION INFORMATION

### Input Decoupling

A 1.0  $\mu\text{F}$  ceramic capacitor is the recommended value to be connected between  $V_{\text{in}}$  and GND. For PCB layout considerations, the traces of  $V_{\text{in}}$  and GND should be sufficiently wide in order to minimize noise and prevent unstable operation.

### Output Decoupling

It is recommended to use a 0.1  $\mu\text{F}$  ceramic capacitor on the  $V_{\text{out}}$  pin. For better performance, select a capacitor with low Equivalent Series Resistance (ESR). For PCB layout considerations, place the output capacitor close to the output pin and keep the leads short as possible.

## ORDERING INFORMATION

Device	Output Type / Features	Nominal Output Voltage	Marking	Package	Shipping†
NCP583SQ15T1G	Active High w/Enable	1.5	A5	SC-82AB (Pb-Free)	3000 / Tape & Reel
NCP583SQ18T1G	Active High w/Enable	1.8	A8	SC-82AB (Pb-Free)	3000 / Tape & Reel
NCP583SQ25T1G	Active High w/Enable	2.5	B5	SC-82AB (Pb-Free)	3000 / Tape & Reel
NCP583SQ27T1G	Active High w/Enable	2.7	B7	SC-82AB (Pb-Free)	3000 / Tape & Reel
NCP583SQ28T1G	Active High w/Enable	2.8	B8	SC-82AB (Pb-Free)	3000 / Tape & Reel
NCP583SQ30T1G	Active High w/Enable	3.0	C0	SC-82AB (Pb-Free)	3000 / Tape & Reel
NCP583SQ33T1G	Active High w/Enable	3.3	C3	SC-82AB (Pb-Free)	3000 / Tape & Reel
NCP583XV15T2G	Active High w/Enable	1.5	G15B	SOT-563 (Pb-Free)	4000 / Tape & Reel
NCP583XV18T2G	Active High w/Enable	1.8	G18B	SOT-563 (Pb-Free)	4000 / Tape & Reel
NCP583XV25T2G	Active High w/Enable	2.5	G25B	SOT-563 (Pb-Free)	4000 / Tape & Reel
NCP583XV26T2G	Active High w/Enable	2.6	G26B	SOT-563 (Pb-Free)	4000 / Tape & Reel
NCP583XV28T2G	Active High w/Enable	2.8	G28B	SOT-563 (Pb-Free)	4000 / Tape & Reel
NCP583XV29T2G	Active High w/Enable	2.9	G29B	SOT-563 (Pb-Free)	4000 / Tape & Reel
NCP583XV30T2G	Active High w/Enable	3.0	G30B	SOT-563 (Pb-Free)	4000 / Tape & Reel
NCP583XV31T2G	Active High w/Enable	3.1	G31B	SOT-563 (Pb-Free)	4000 / Tape & Reel
NCP583XV33T2G	Active High w/Enable	3.3	G33B	SOT-563 (Pb-Free)	4000 / Tape & Reel

†For information on tape and reel specifications, including part orientation and tape sizes, please refer to our Tape and Reel Packaging Specification Brochure, BRD8011/D.

Other voltages are available. Consult your ON Semiconductor representative.



# MECHANICAL CASE OUTLINE

## PACKAGE DIMENSIONS

ON Semiconductor®



**SC-82AB**  
CASE 419C-02  
ISSUE F

DATE 22 JUN 2012

SCALE 4:1

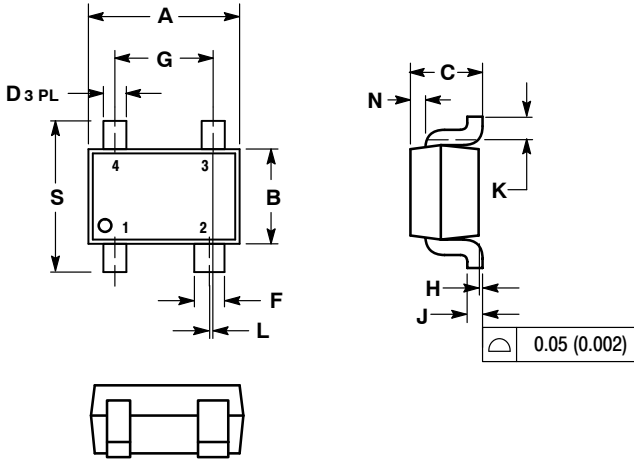

**NOTES:**

1. DIMENSIONING AND TOLERANCING PER ANSI Y14.5M, 1982.
2. CONTROLLING DIMENSION: MILLIMETER.
3. 419C-01 OBSOLETE. NEW STANDARD IS 419C-02.
4. DIMENSIONS A AND B DO NOT INCLUDE MOLD FLASH, PROTRUSIONS, OR GATE BURRS.

DIM	MILLIMETERS		INCHES	
	MIN	MAX	MIN	MAX
A	1.80	2.20	0.071	0.087
B	1.15	1.35	0.045	0.053
C	0.80	1.10	0.031	0.043
D	0.20	0.40	0.008	0.016
F	0.30	0.50	0.012	0.020
G	1.10	1.50	0.043	0.059
H	0.00	0.10	0.000	0.004
J	0.10	0.26	0.004	0.010
K	0.10	---	0.004	---
L	0.05 BSC		0.002 BSC	
N	0.20 REF		0.008 REF	
S	1.80	2.40	0.07	0.09

**SOLDERING FOOTPRINT\***



**GENERIC MARKING DIAGRAM\***



- XXX = Specific Device Code
- M = Month Code
- = Pb-Free Package

\*This information is generic. Please refer to device data sheet for actual part marking. Pb-Free indicator, "G" or microdot "▪", may or may not be present.

\*For additional information on our Pb-Free strategy and soldering details, please download the ON Semiconductor Soldering and Mounting Techniques Reference Manual, SOLDERRM/D.

<b>DOCUMENT NUMBER:</b>	<b>98ARB18939C</b>	Electronic versions are uncontrolled except when accessed directly from the Document Repository. Printed versions are uncontrolled except when stamped "CONTROLLED COPY" in red.
<b>DESCRIPTION:</b>	<b>SC-82AB</b>	<b>PAGE 1 OF 1</b>

ON Semiconductor and are trademarks of Semiconductor Components Industries, LLC dba ON Semiconductor or its subsidiaries in the United States and/or other countries. ON Semiconductor reserves the right to make changes without further notice to any products herein. ON Semiconductor makes no warranty, representation or guarantee regarding the suitability of its products for any particular purpose, nor does ON Semiconductor assume any liability arising out of the application or use of any product or circuit, and specifically disclaims any and all liability, including without limitation special, consequential or incidental damages. ON Semiconductor does not convey any license under its patent rights nor the rights of others.

# MECHANICAL CASE OUTLINE

## PACKAGE DIMENSIONS

ON Semiconductor®



SCALE 4:1

**SOT-563, 6 LEAD**  
CASE 463A  
ISSUE H

DATE 26 JAN 2021

**NOTES:**

1. DIMENSIONING AND TOLERANCING PER ASME Y14.5M, 2009.
2. CONTROLLING DIMENSION: MILLIMETERS
3. MAXIMUM LEAD THICKNESS INCLUDES LEAD FINISH THICKNESS. MINIMUM LEAD THICKNESS IS THE MINIMUM THICKNESS OF BASE MATERIAL.

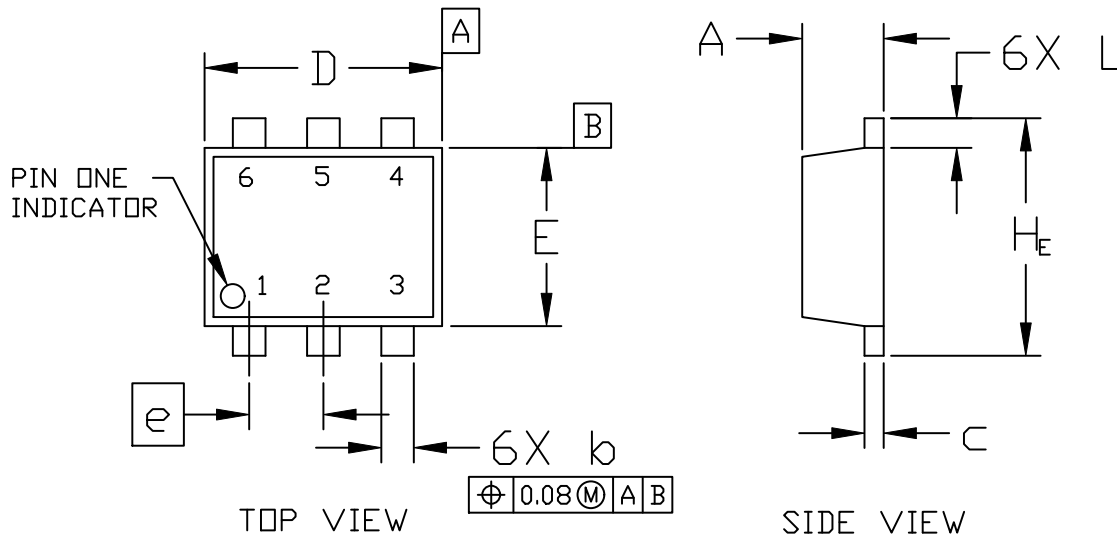

DIM	MILLIMETERS		
	MIN.	NOM.	MAX.
A	0.50	0.55	0.60
b	0.17	0.22	0.27
c	0.08	0.13	0.18
D	1.50	1.60	1.70
E	1.10	1.20	1.30
e	0.50 BSC		
L	0.10	0.20	0.30
H <sub>E</sub>	1.50	1.60	1.70

**RECOMMENDED MOUNTING FOOTPRINT\***

\* For additional information on our Pb-Free strategy and soldering details, please download the ON Semiconductor Soldering and Mounting Techniques Reference Manual, SOLDERRM/D.

<b>DOCUMENT NUMBER:</b>	<b>98AON11126D</b>	Electronic versions are uncontrolled except when accessed directly from the Document Repository. Printed versions are uncontrolled except when stamped "CONTROLLED COPY" in red.
<b>DESCRIPTION:</b>	<b>SOT-563, 6 LEAD</b>	<b>PAGE 1 OF 2</b>

ON Semiconductor and are trademarks of Semiconductor Components Industries, LLC dba ON Semiconductor or its subsidiaries in the United States and/or other countries. ON Semiconductor reserves the right to make changes without further notice to any products herein. ON Semiconductor makes no warranty, representation or guarantee regarding the suitability of its products for any particular purpose, nor does ON Semiconductor assume any liability arising out of the application or use of any product or circuit, and specifically disclaims any and all liability, including without limitation special, consequential or incidental damages. ON Semiconductor does not convey any license under its patent rights nor the rights of others.

**SOT-563, 6 LEAD**  
CASE 463A  
ISSUE H

DATE 26 JAN 2021

STYLE 1:  
PIN 1. EMITTER 1  
2. BASE 1  
3. COLLECTOR 2  
4. EMITTER 2  
5. BASE 2  
6. COLLECTOR 1

STYLE 2:  
PIN 1. EMITTER 1  
2. EMITTER 2  
3. BASE 2  
4. COLLECTOR 2  
5. BASE 1  
6. COLLECTOR 1

STYLE 3:  
PIN 1. CATHODE 1  
2. CATHODE 1  
3. ANODE/ANODE 2  
4. CATHODE 2  
5. CATHODE 2  
6. ANODE/ANODE 1

STYLE 4:  
PIN 1. COLLECTOR  
2. COLLECTOR  
3. BASE  
4. EMITTER  
5. COLLECTOR  
6. COLLECTOR

STYLE 5:  
PIN 1. CATHODE  
2. CATHODE  
3. ANODE  
4. ANODE  
5. CATHODE  
6. CATHODE

STYLE 6:  
PIN 1. CATHODE  
2. ANODE  
3. CATHODE  
4. CATHODE  
5. CATHODE  
6. CATHODE

STYLE 7:  
PIN 1. CATHODE  
2. ANODE  
3. CATHODE  
4. CATHODE  
5. ANODE  
6. CATHODE

STYLE 8:  
PIN 1. DRAIN  
2. DRAIN  
3. GATE  
4. SOURCE  
5. DRAIN  
6. DRAIN

STYLE 9:  
PIN 1. SOURCE 1  
2. GATE 1  
3. DRAIN 2  
4. SOURCE 2  
5. GATE 2  
6. DRAIN 1

STYLE 10:  
PIN 1. CATHODE 1  
2. N/C  
3. CATHODE 2  
4. ANODE 2  
5. N/C  
6. ANODE 1

STYLE 11:  
PIN 1. EMITTER 2  
2. BASE 2  
3. COLLECTOR 1  
4. EMITTER 1  
5. BASE 1  
6. COLLECTOR 2

**GENERIC  
MARKING DIAGRAM\***



XX = Specific Device Code  
M = Month Code  
■ = Pb-Free Package

\*This information is generic. Please refer to device data sheet for actual part marking. Pb-Free indicator, "G" or microdot "■", may or may not be present. Some products may not follow the Generic Marking.

<b>DOCUMENT NUMBER:</b>	<b>98AON11126D</b>	Electronic versions are uncontrolled except when accessed directly from the Document Repository. Printed versions are uncontrolled except when stamped "CONTROLLED COPY" in red.
<b>DESCRIPTION:</b>	<b>SOT-563, 6 LEAD</b>	<b>PAGE 2 OF 2</b>

ON Semiconductor and are trademarks of Semiconductor Components Industries, LLC dba ON Semiconductor or its subsidiaries in the United States and/or other countries. ON Semiconductor reserves the right to make changes without further notice to any products herein. ON Semiconductor makes no warranty, representation or guarantee regarding the suitability of its products for any particular purpose, nor does ON Semiconductor assume any liability arising out of the application or use of any product or circuit, and specifically disclaims any and all liability, including without limitation special, consequential or incidental damages. ON Semiconductor does not convey any license under its patent rights nor the rights of others.

**onsemi**, **Onsemi**, and other names, marks, and brands are registered and/or common law trademarks of Semiconductor Components Industries, LLC dba "**onsemi**" or its affiliates and/or subsidiaries in the United States and/or other countries. **onsemi** owns the rights to a number of patents, trademarks, copyrights, trade secrets, and other intellectual property. A listing of **onsemi**'s product/patent coverage may be accessed at [www.onsemi.com/site/pdf/Patent-Marking.pdf](http://www.onsemi.com/site/pdf/Patent-Marking.pdf). **onsemi** reserves the right to make changes at any time to any products or information herein, without notice. The information herein is provided "as-is" and **onsemi** makes no warranty, representation or guarantee regarding the accuracy of the information, product features, availability, functionality, or suitability of its products for any particular purpose, nor does **onsemi** assume any liability arising out of the application or use of any product or circuit, and specifically disclaims any and all liability, including without limitation special, consequential or incidental damages. Buyer is responsible for its products and applications using **onsemi** products, including compliance with all laws, regulations and safety requirements or standards, regardless of any support or applications information provided by **onsemi**. "Typical" parameters which may be provided in **onsemi** data sheets and/or specifications can and do vary in different applications and actual performance may vary over time. All operating parameters, including "Typicals" must be validated for each customer application by customer's technical experts. **onsemi** does not convey any license under any of its intellectual property rights nor the rights of others. **onsemi** products are not designed, intended, or authorized for use as a critical component in life support systems or any FDA Class 3 medical devices or medical devices with a same or similar classification in a foreign jurisdiction or any devices intended for implantation in the human body. Should Buyer purchase or use **onsemi** products for any such unintended or unauthorized application, Buyer shall indemnify and hold **onsemi** and its officers, employees, subsidiaries, affiliates, and distributors harmless against all claims, costs, damages, and expenses, and reasonable attorney fees arising out of, directly or indirectly, any claim of personal injury or death associated with such unintended or unauthorized use, even if such claim alleges that **onsemi** was negligent regarding the design or manufacture of the part. **onsemi** is an Equal Opportunity/Affirmative Action Employer. This literature is subject to all applicable copyright laws and is not for resale in any manner.

## PUBLICATION ORDERING INFORMATION

### LITERATURE FULFILLMENT:

Email Requests to: [orderlit@onsemi.com](mailto:orderlit@onsemi.com)

**onsemi Website:** [www.onsemi.com](http://www.onsemi.com)

### TECHNICAL SUPPORT

**North American Technical Support:**

Voice Mail: 1 800-282-9855 Toll Free USA/Canada

Phone: 011 421 33 790 2910

**Europe, Middle East and Africa Technical Support:**

Phone: 00421 33 790 2910

For additional information, please contact your local Sales Representative