

MFBW1V1005

Multilayer chip ferrite bead

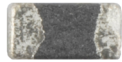

Product features

- 0402 (1005 metric) package
- High impedance values
- Multilayer monolithic construction yields high reliability
- Impedance range from 0 Ω to 1000 Ω

Applications

- Industrial connectivity (IoT)
- Wireless communications
- Bluetooth
- WiFi
- Antenna
- Machine-to-machine (M2M)
- Mobile phones
- Wearable devices
- Wireless LAN
- Computing/gaming consoles
- Broadband components
- RF transceiver modules

Environmental compliance and general specifications

- Operating temperature range: -55 °C to +125 °C (ambient plus self-temperature rise)



Product specifications

Part number ³	Impedance tolerance	Impedance (Ω)	DCR (Ω) maximum @ +25 °C	Test frequency ¹ (MHz)	Test voltage ¹ (mV)	Rated current ² (mA) maximum
MFBW1V1005-000-R	0~15 Ω	0	0.04	100	50	800
MFBW1V1005-050-R	0~15 Ω	5	0.04	100	50	800
MFBW1V1005-070-R	0~11 Ω	7	0.04	100	50	800
MFBW1V1005-090-R	5~13 Ω	9	0.04	100	50	800
MFBW1V1005-110-R	7~15 Ω	11	0.04	100	50	800
MFBW1V1005-150-R	9~21 Ω	15	0.04	100	50	800
MFBW1V1005-190-R	12~25 Ω	19	0.06	100	50	700
MFBW1V1005-260-R	±25%	26	0.06	100	50	700
MFBW1V1005-310-R	±25%	31	0.08	100	50	700
MFBW1V1005-360-R	±25%	36	0.15	100	50	600
MFBW1V1005-500-R	±25%	50	0.15	100	50	600
MFBW1V1005-600-R	±25%	60	0.15	100	50	600
MFBW1V1005-700-R	±25%	70	0.20	100	50	450
MFBW1V1005-750-R	±25%	75	0.20	100	50	450
MFBW1V1005-800-R	±25%	80	0.20	100	50	450
MFBW1V1005-101-R	±25%	100	0.20	100	50	450
MFBW1V1005-121-R	±25%	120	0.25	100	50	450
MFBW1V1005-151-R	±25%	150	0.25	100	50	450
MFBW1V1005-181-R	±25%	180	0.40	100	50	450
MFBW1V1005-201-R	±25%	200	0.40	100	50	300
MFBW1V1005-221-R	±25%	220	0.40	100	50	300
MFBW1V1005-301-R	±25%	300	0.50	100	50	300
MFBW1V1005-501-R	±25%	500	0.65	100	50	200
MFBW1V1005-601-R	±25%	600	0.70	100	50	200
MFBW1V1005-801-R	±25%	800	0.90	100	50	200
MFBW1V1005-102-R	±25%	1000	1.00	100	50	200

1. Impedance test frequency and voltage.

2. Rated current: Current rating for an approximate self-temperature rise of 40 °C or less.

3. Part number definition: MFBW1V1005-xxx-R

MFBW1V1005 = Product code and size

xxx = Impedance value in Ω, last character equals number of zeros

-R suffix = RoHS compliant

Mechanical parameters, schematic, pad layout (mm)

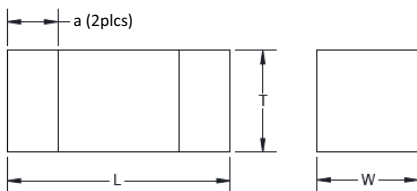
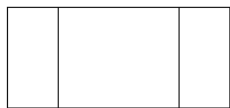

Recommended pad layout

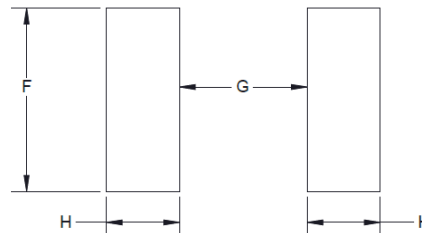

Schematic

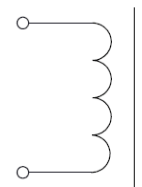

Part number	L	W	T	a	F	G	H
MFBW1V1005-xxx-R	1.0 ±0.15	0.50 ±0.15	0.50 ±0.15	0.25 ±0.1	0.90 ref	0.20 ref	0.80 ref

Part marking: No marking

All soldering surfaces to be coplanar within 0.1 millimeters

Tolerances are ±0.1 millimeters unless stated otherwise

Pad layout dimensions are reference only

Traces or vias underneath the inductor is not recommended

Packaging information (mm)

Drawing not to scale

Supplied in tape and reel packaging, 10000 parts per 7" diameter reel

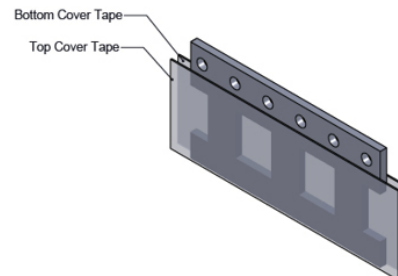
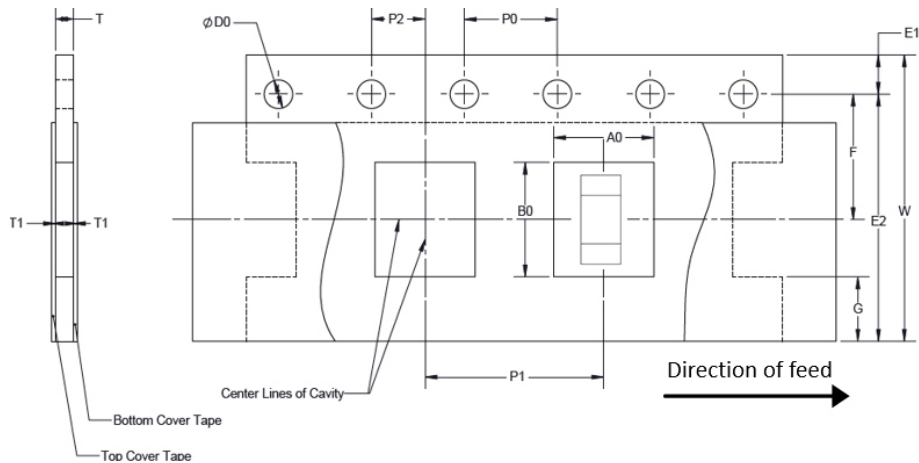

$W \pm 0.2$	8.00
$F \pm 0.1$	3.50
$E1 \pm 0.2$	1.75
$E2$ Min	na
$P0 \pm 0.2$	4.00
$P1 \pm 0.2$	2.00
$P2 \pm 0.1$	2.00
$D0 \pm 0.1$	1.55
A0	0.65 ± 0.1
B0	1.15 ± 0.1
T	0.6 ± 0.1
T1 Max	na

Qualification testing

No.	Test item	Sample size (pcs)	Test condition	Acceptable value/range
1	External visual	72	Specification	No physical damage
2	Physical dimension	72	Specification	Specification
3	Initial electrical test	72	Specification	User specification
4	Solderability	6	+245 °C ±5 °C, dipping 5 ±1s	>95% solder coverage
5	Resistance to soldering heat	6	+260 ±5 °C for 10 ±1 s	1. $\Delta Z/Z < \pm 30\%$ 2. No physical damage
6	Terminal strength (SMD)	6	Force of 5 N for 10 ±1 s	No physical damage No electrical performance test
7	Low temperature exposure	6	-55 °C for 1000 hours	1. $\Delta Z/Z < \pm 30\%$ 2. No physical damage
8	Bending strength	6	Appendix 2 note: 2 mm, hold time 30 s (minimum)	No physical damage No electrical performance test
9	Drop	6	Drop 10 times to a concrete floor from a height of 1 m	1. $\Delta Z/Z < \pm 30\%$ 2. No physical damage
10	Vibration	6	Amplitude modulation: 1.5 mm Test time: A period of 2 hours in each of 3 mutually perpendicular directions Test from 10 Hz to 55 Hz to 10 Hz for 1 minute	1. $\Delta Z/Z < \pm 30\%$ 2. No physical damage
11	High temperature exposure	6	+125 °C for 1000 hours	1. $\Delta Z/Z < \pm 30\%$ 2. No physical damage
12	Biased humidity	6	1000 hours +60 °C/90% to 95% RH unpowered	1. $\Delta Z/Z < \pm 30\%$ 2. No physical damage
13	Operational life	12	+85 °C at rated current for 1000 hours	1. $\Delta Z/Z < \pm 30\%$ 2. No physical damage
14	Temperature cycling	6	32 cycles (-55 °C to +125 °C), dwell time 30 minutes	1. $\Delta Z/Z < \pm 30\%$ 2. No physical damage

Impedance vs frequency

MFBW1V1005-000-R

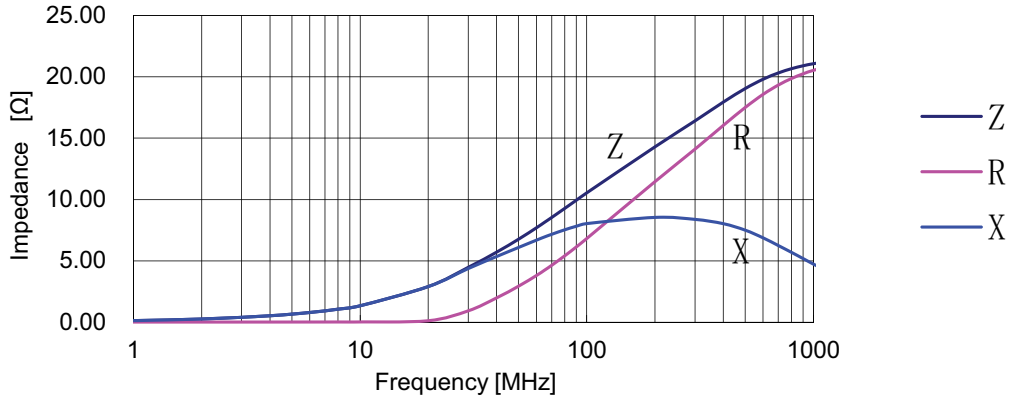

MFBW1V1005-700-R

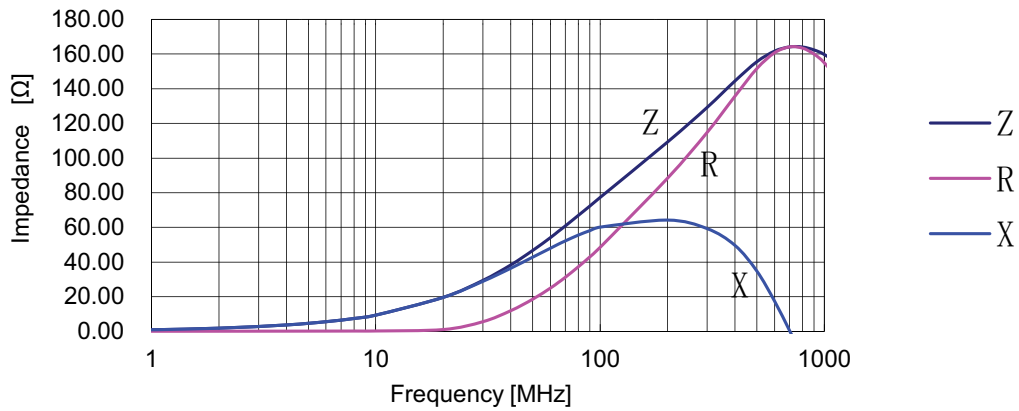

MFBW1V1005-102-R

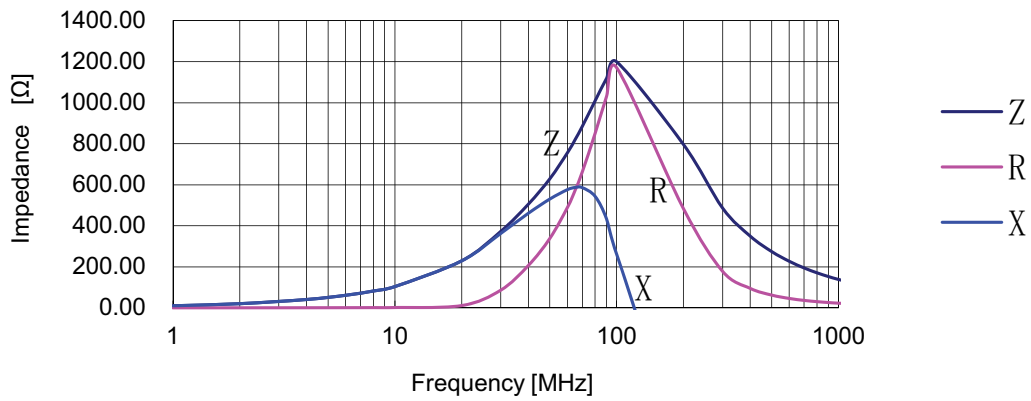

Z= impedance, R= resistance, X= reactance

Solder reflow profile

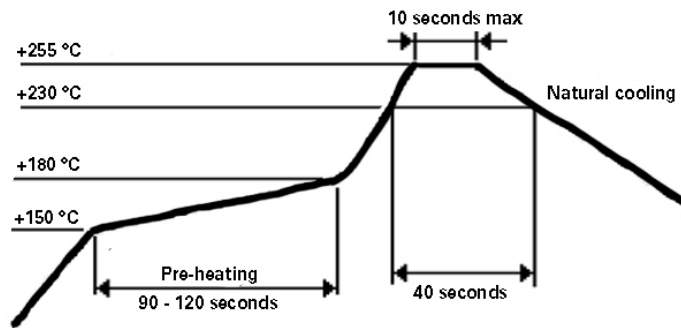

Life Support Policy: Eaton does not authorize the use of any of its products for use in life support devices or systems without the express written approval of an officer of the Company. Life support systems are devices which support or sustain life, and whose failure to perform, when properly used in accordance with instructions for use provided in the labeling, can be reasonably expected to result in significant injury to the user.

Eaton reserves the right, without notice, to change design or construction of any products and to discontinue or limit distribution of any products. Eaton also reserves the right to change or update, without notice, any technical information contained in this bulletin.

Eaton
Electronics Division
1000 Eaton Boulevard
Cleveland, OH 44122
United States
Eaton.com/electronics

© 2021 Eaton
All Rights Reserved
Printed in USA
Publication No. 11106
November 2021

Eaton is a registered trademark.

All other trademarks are property
of their respective owners.

Follow us on social media to get the
latest product and support information.

