

## N-channel 600 V, 37 mΩ typ., 66 A MDmesh™ DM2 Power MOSFET in a TO-247 package

**TO-247**

AM01475V1

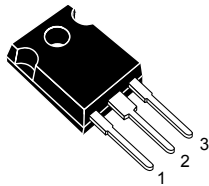
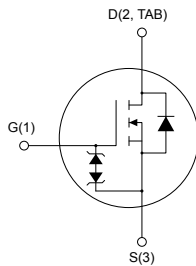

### Features

Order code	V <sub>DS</sub>	R <sub>DS(on)</sub> max.	I <sub>D</sub>	P <sub>TOT</sub>
STW70N60DM2	600 V	42 mΩ	66 A	446 W

- Fast-recovery body diode
- Extremely low gate charge and input capacitance
- Low on-resistance
- 100% avalanche tested
- Extremely high dv/dt ruggedness
- Zener-protected

### Applications

- Switching applications

### Description

This high-voltage N-channel Power MOSFET is part of the MDmesh™ DM2 fast-recovery diode series. It offers very low recovery charge (Q<sub>rr</sub>) and time (t<sub>rr</sub>) combined with low R<sub>DS(on)</sub>, rendering it suitable for the most demanding high-efficiency converters and ideal for bridge topologies and ZVS phase-shift converters.

#### Product status link

[STW70N60DM2](#)

#### Product summary

<b>Order code</b>	STW70N60DM2
<b>Marking</b>	70N60DM2
<b>Package</b>	TO-247
<b>Packing</b>	Tube

# 1 Electrical ratings

**Table 1. Absolute maximum ratings**

Symbol	Parameter	Value	Unit
$V_{GS}$	Gate-source voltage	$\pm 25$	V
$I_D$	Drain current (continuous) at $T_{case} = 25\text{ }^\circ\text{C}$	66	A
	Drain current (continuous) at $T_{case} = 100\text{ }^\circ\text{C}$	42	
$I_{DM}^{(1)}$	Drain current (pulsed)	264	A
$P_{TOT}$	Total power dissipation at $T_{case} = 25\text{ }^\circ\text{C}$	446	W
$dv/dt^{(2)}$	Peak diode recovery voltage slope	50	V/ns
$dv/dt^{(3)}$	MOSFET $dv/dt$ ruggedness	50	
$T_{stg}$	Storage temperature range	-55 to 150	$^\circ\text{C}$
$T_j$	Operating junction temperature range		

1. Pulse width is limited by safe operating area.
2.  $I_{SD} \leq 66\text{ A}$ ,  $di/dt=900\text{ A}/\mu\text{s}$ ;  $V_{DS\text{ peak}} < V_{(BR)DSS}$ .  $V_{DD} = 400\text{ V}$ .
3.  $V_{DS} \leq 480\text{ V}$ .

**Table 2. Thermal data**

Symbol	Parameter	Value	Unit
$R_{thj-case}$	Thermal resistance junction-case	0.28	$^\circ\text{C}/\text{W}$
$R_{thj-amb}$	Thermal resistance junction-ambient	50	

**Table 3. Avalanche characteristics**

Symbol	Parameter	Value	Unit
$I_{AR}$	Avalanche current, repetitive or not repetitive <sup>(1)</sup>	10	A
$E_{AS}$	Single pulse avalanche energy <sup>(2)</sup>	1500	mJ

1. Pulse width limited by  $T_{JMAX}$ .
2. Starting  $T_j = 25\text{ }^\circ\text{C}$ ,  $I_D = I_{AR}$ ,  $V_{DD} = 50\text{ V}$

## 2 Electrical characteristics

( $T_{case} = 25\text{ °C}$  unless otherwise specified).

**Table 4. Static**

Symbol	Parameter	Test conditions	Min.	Typ.	Max.	Unit
$V_{(BR)DSS}$	Drain-source breakdown voltage	$V_{GS} = 0\text{ V}$ , $I_D = 1\text{ mA}$	600			V
$I_{DSS}$	Zero gate voltage drain current	$V_{GS} = 0\text{ V}$ , $V_{DS} = 600\text{ V}$			10	$\mu\text{A}$
		$V_{GS} = 0\text{ V}$ , $V_{DS} = 600\text{ V}$ , $T_{case} = 125\text{ °C}^{(1)}$			100	
$I_{GSS}$	Gate-body leakage current	$V_{DS} = 0\text{ V}$ , $V_{GS} = \pm 25\text{ V}$			$\pm 5$	$\mu\text{A}$
$V_{GS(th)}$	Gate threshold voltage	$V_{DS} = V_{GS}$ , $I_D = 250\text{ }\mu\text{A}$	3	4	5	V
$R_{DS(on)}$	Static drain-source on-resistance	$V_{GS} = 10\text{ V}$ , $I_D = 33\text{ A}$		37	42	$\text{m}\Omega$

1. Defined by design, not subject to production test.

**Table 5. Dynamic**

Symbol	Parameter	Test conditions	Min.	Typ.	Max.	Unit
$C_{iss}$	Input capacitance	$V_{DS} = 100\text{ V}$ , $f = 1\text{ MHz}$ , $V_{GS} = 0\text{ V}$	-	5508	-	$\text{pF}$
$C_{oss}$	Output capacitance		-	241	-	
$C_{riss}$	Reverse transfer capacitance		-	2.8	-	
$C_{oss\text{ eq.}}^{(1)}$	Equivalent output capacitance	$V_{DS} = 0\text{ to }480\text{ V}$ , $V_{GS} = 0\text{ V}$	-	470	-	$\text{pF}$
$R_G$	Intrinsic gate resistance	$f = 1\text{ MHz}$ , $I_D = 0\text{ A}$	-	2	-	$\Omega$
$Q_g$	Total gate charge	$V_{DD} = 480\text{ V}$ , $I_D = 66\text{ A}$ , $V_{GS} = 0\text{ to }10\text{ V}$ (see Figure 14. Test circuit for gate charge behavior)	-	121	-	$\text{nC}$
$Q_{gs}$	Gate-source charge		-	26	-	
$Q_{gd}$	Gate-drain charge		-	61	-	

1.  $C_{oss\text{ eq.}}$  is defined as a constant equivalent capacitance giving the same charging time as  $C_{oss}$  when  $V_{DS}$  increases from 0 to 80%  $V_{DSS}$ .

**Table 6. Switching times**

Symbol	Parameter	Test conditions	Min.	Typ.	Max.	Unit
$t_{d(on)}$	Turn-on delay time	$V_{DD} = 300\text{ V}$ , $I_D = 33\text{ A}$ , $R_G = 4.7\text{ }\Omega$ , $V_{GS} = 10\text{ V}$ (see Figure 13. Test circuit for resistive load switching times and Figure 18. Switching time waveform)	-	32	-	$\text{ns}$
$t_r$	Rise time		-	67	-	
$t_{d(off)}$	Turn-off delay time		-	112	-	
$t_f$	Fall time		-	10.4	-	

**Table 7. Source-drain diode**

Symbol	Parameter	Test conditions	Min.	Typ.	Max.	Unit
$I_{SD}$	Source-drain current		-		66	A
$I_{SDM}^{(1)}$	Source-drain current (pulsed)		-		264	A
$V_{SD}^{(2)}$	Forward on voltage	$V_{GS} = 0\text{ V}$ , $I_{SD} = 66\text{ A}$	-		1.6	V
$t_{rr}$	Reverse recovery time	$I_{SD} = 66\text{ A}$ , $di/dt = 100\text{ A}/\mu\text{s}$ , $V_{DD} = 60\text{ V}$ (see )Figure 15. Test circuit for inductive load switching and diode recovery times	-	150		ns
$Q_{rr}$	Reverse recovery charge		-	0.75		$\mu\text{C}$
$I_{RRM}$	Reverse recovery current		-	10.5		A
$t_{rr}$	Reverse recovery time	$I_{SD} = 66\text{ A}$ , $di/dt = 100\text{ A}/\mu\text{s}$ , $V_{DD} = 60\text{ V}$ , $T_j = 150\text{ }^\circ\text{C}$ (see )Figure 15. Test circuit for inductive load switching and diode recovery times	-	250		ns
$Q_{rr}$	Reverse recovery charge		-	2.5		$\mu\text{C}$
$I_{RRM}$	Reverse recovery current		-	20.7		A

1. Pulse width is limited by safe operating area.
2. Pulse test: pulse duration = 300  $\mu\text{s}$ , duty cycle 1.5%.

## 2.1 Electrical characteristics (curves)

Figure 1. Safe operating area

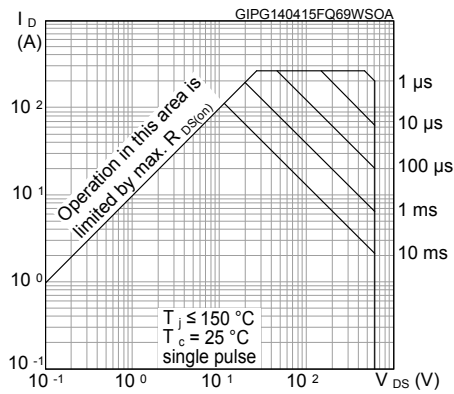

Figure 2. Thermal impedance

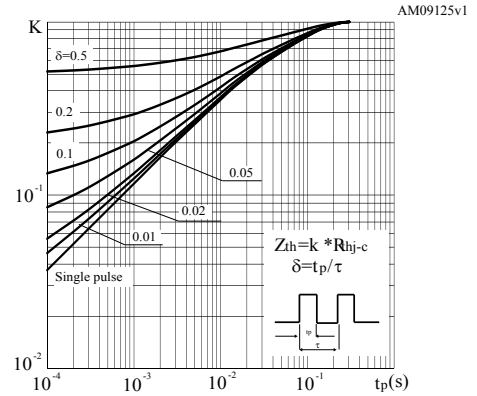

Figure 3. Output characteristics

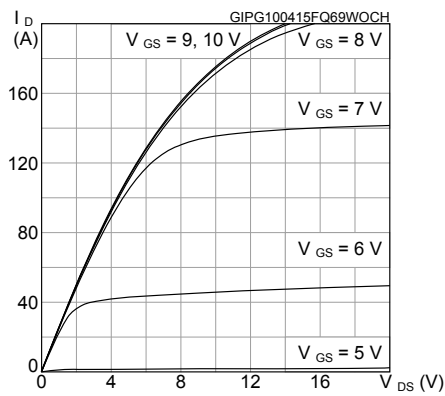

Figure 4. Transfer characteristics

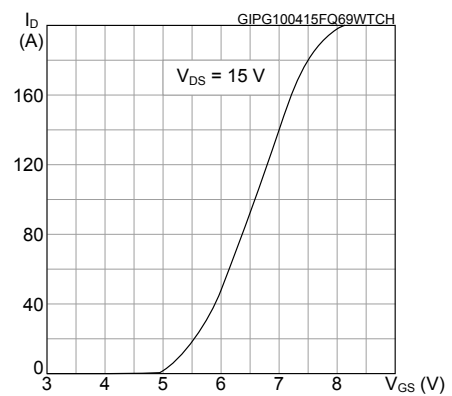

Figure 5. Gate charge vs gate-source voltage

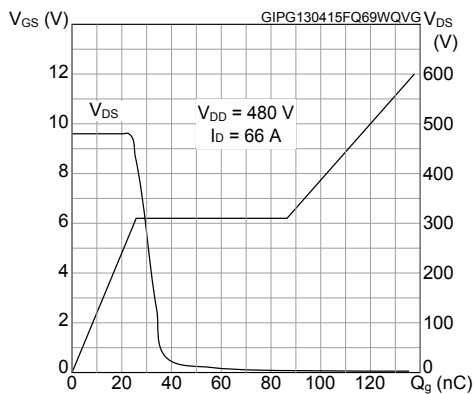

Figure 6. Static drain-source on-resistance

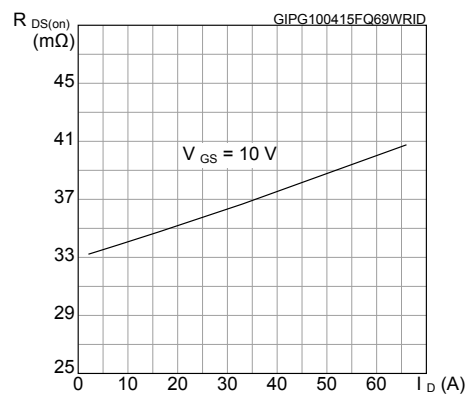

Figure 7. Capacitance variations

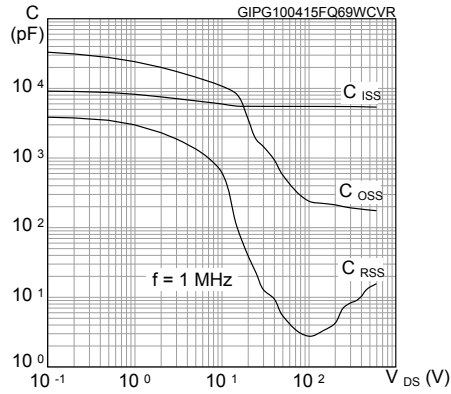

Figure 8. Normalized gate threshold voltage vs temperature

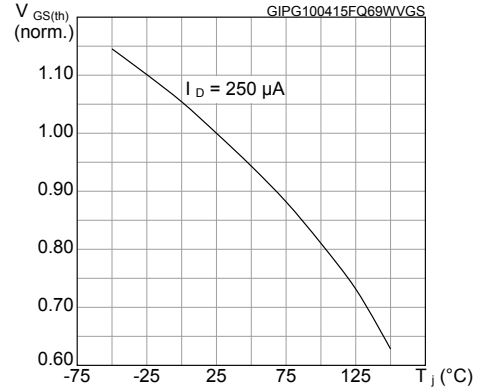

Figure 9. Normalized on-resistance vs temperature

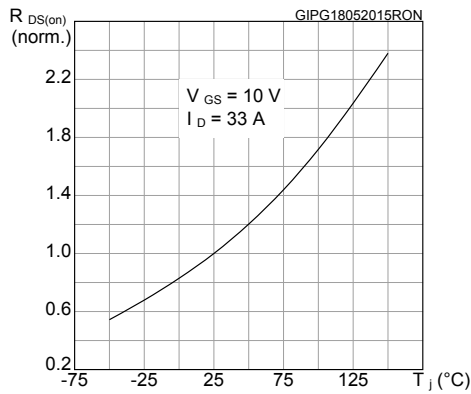

Figure 10. Normalized  $V_{(BR)DSS}$  vs temperature

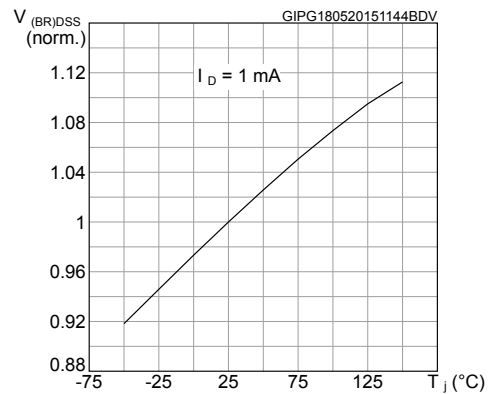

Figure 11. Output capacitance stored energy

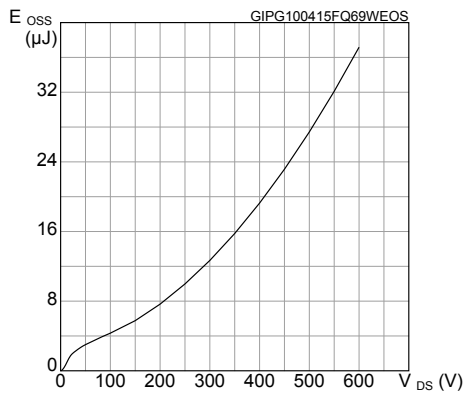
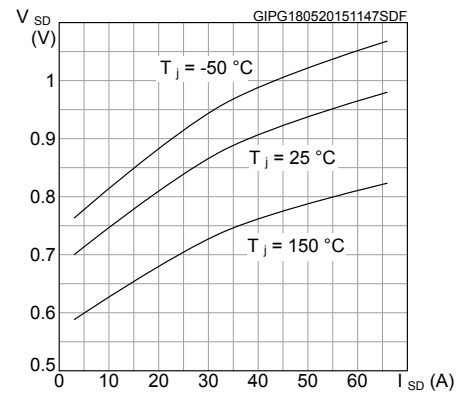

Figure 12. Source-drain diode forward characteristics



### 3 Test circuits

**Figure 13. Test circuit for resistive load switching times**

AM01468v1

**Figure 14. Test circuit for gate charge behavior**

AM01469v1

**Figure 15. Test circuit for inductive load switching and diode recovery times**

AM01470v1

**Figure 16. Unclamped inductive load test circuit**

AM01471v1

**Figure 17. Unclamped inductive waveform**

AM01472v1

**Figure 18. Switching time waveform**

AM01473v1

## 4 Package information

---

In order to meet environmental requirements, ST offers these devices in different grades of **ECOPACK®** packages, depending on their level of environmental compliance. ECOPACK® specifications, grade definitions and product status are available at: [www.st.com](http://www.st.com). ECOPACK® is an ST trademark.



### 4.1 TO-247 package information

Figure 19. TO-247 package outline

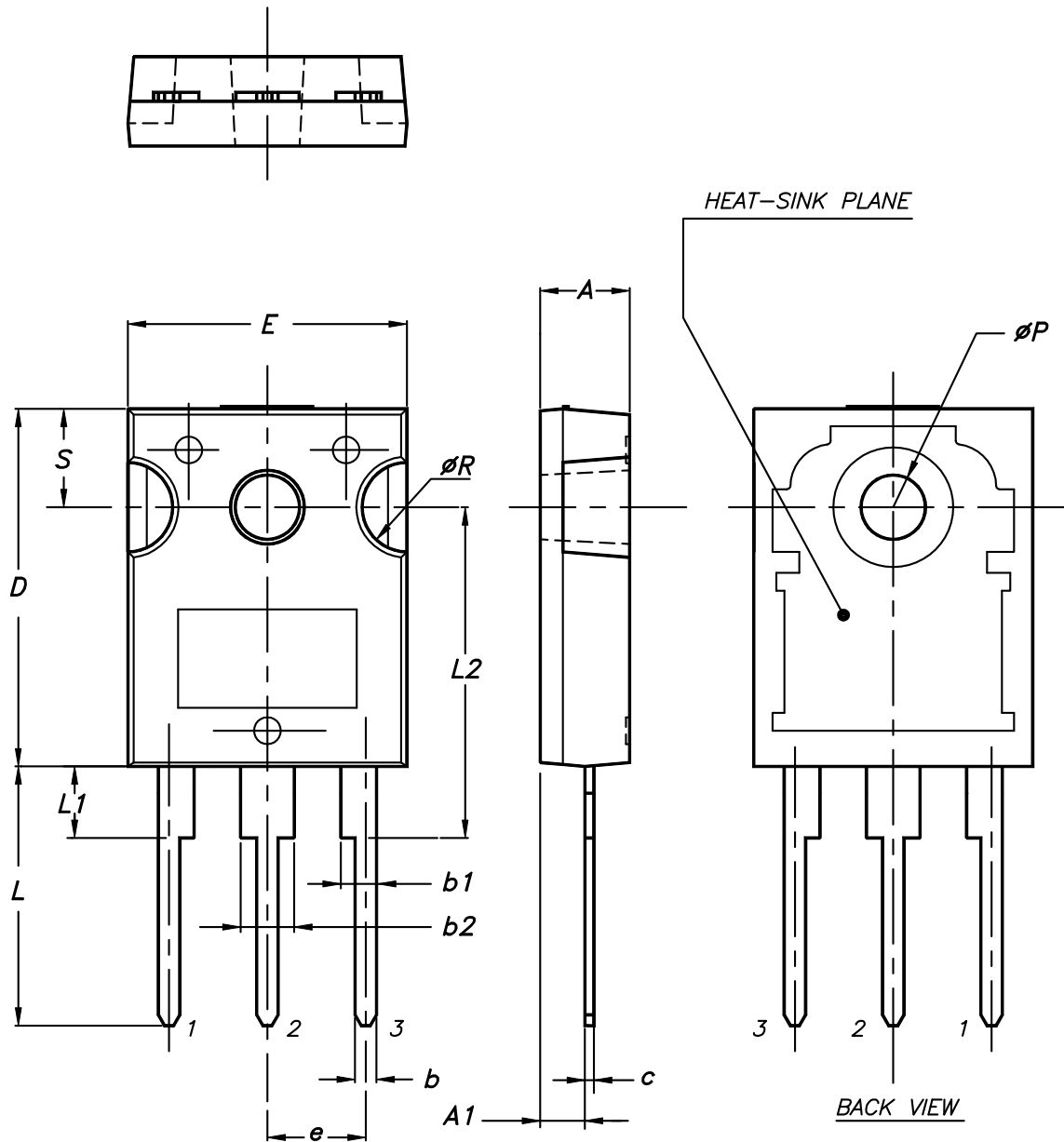

0075325\_9

**Table 8. TO-247 package mechanical data**

Dim.	mm		
	Min.	Typ.	Max.
A	4.85		5.15
A1	2.20		2.60
b	1.0		1.40
b1	2.0		2.40
b2	3.0		3.40
c	0.40		0.80
D	19.85		20.15
E	15.45		15.75
e	5.30	5.45	5.60
L	14.20		14.80
L1	3.70		4.30
L2		18.50	
ØP	3.55		3.65
ØR	4.50		5.50
S	5.30	5.50	5.70

## Revision history

**Table 9. Document revision history**

Date	Revision	Changes
04-Sep-2014	1	First release.
18-May-2015	2	Document status promoted from preliminary to production data. Added Section 2.1 Electrical characteristics (curves).
08-Jul-2015	3	Text and formatting changes throughout document in Section Electrical characteristics: - updated Tables Dynamic and Source-drain diode
09-Dec-2015	4	Updated <i>Table 4: "Avalanche characteristics"</i> .
12-Nov-2018	5	Updated <a href="#">Section 4.1 TO-247 package information</a> . Minor text changes.

## Contents

<b>1</b>	<b>Electrical ratings</b> .....	<b>2</b>
<b>2</b>	<b>Electrical characteristics</b> .....	<b>3</b>
<b>2.1</b>	<b>Electrical characteristics (curves)</b> .....	<b>5</b>
<b>3</b>	<b>Test circuits</b> .....	<b>7</b>
<b>4</b>	<b>Package information</b> .....	<b>8</b>
<b>4.1</b>	<b>TO-247 package information</b> .....	<b>9</b>
	<b>Revision history</b> .....	<b>11</b>

**IMPORTANT NOTICE – PLEASE READ CAREFULLY**

STMicroelectronics NV and its subsidiaries (“ST”) reserve the right to make changes, corrections, enhancements, modifications, and improvements to ST products and/or to this document at any time without notice. Purchasers should obtain the latest relevant information on ST products before placing orders. ST products are sold pursuant to ST’s terms and conditions of sale in place at the time of order acknowledgement.

Purchasers are solely responsible for the choice, selection, and use of ST products and ST assumes no liability for application assistance or the design of Purchasers’ products.

No license, express or implied, to any intellectual property right is granted by ST herein.

Resale of ST products with provisions different from the information set forth herein shall void any warranty granted by ST for such product.

ST and the ST logo are trademarks of ST. All other product or service names are the property of their respective owners.

Information in this document supersedes and replaces information previously supplied in any prior versions of this document.

© 2018 STMicroelectronics – All rights reserved