

# PolarHV™ Power MOSFET

**IXTQ 22N60P**  
**IXTV 22N60P**  
**IXTV 22N60PS**

$V_{DSS} = 600 \text{ V}$   
 $I_{D25} = 22 \text{ A}$   
 $R_{DS(on)} \leq 350 \text{ m}\Omega$

N-Channel Enhancement Mode  
Avalanche Rated

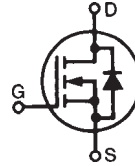

Symbol	Test Conditions	Maximum Ratings	
$V_{DSS}$	$T_J = 25^\circ\text{C to } 150^\circ\text{C}$	600	V
$V_{DGR}$	$T_J = 25^\circ\text{C to } 150^\circ\text{C}; R_{GS} = 1 \text{ M}\Omega$	600	V
$V_{GS}$	Continuous	$\pm 30$	V
$V_{GSM}$	Transient	$\pm 40$	V
$I_{D25}$	$T_C = 25^\circ\text{C}$	22	A
$I_{DM}$	$T_C = 25^\circ\text{C}$ , pulse width limited by $T_{JM}$	66	A
$I_{AR}$	$T_C = 25^\circ\text{C}$	22	A
$E_{AR}$	$T_C = 25^\circ\text{C}$	40	mJ
$E_{AS}$	$T_C = 25^\circ\text{C}$	1.0	J
$dv/dt$	$I_S \leq I_{DM}$ , $di/dt \leq 100 \text{ A}/\mu\text{s}$ , $V_{DD} \leq V_{DSS}$ , $T_J \leq 150^\circ\text{C}$ , $R_G = 4 \Omega$	10	V/ns
$P_D$	$T_C = 25^\circ\text{C}$	400	W
$T_J$		-55 ... +150	$^\circ\text{C}$
$T_{JM}$		150	$^\circ\text{C}$
$T_{stg}$		-55 ... +150	$^\circ\text{C}$
$T_L$	1.6 mm (0.062 in.) from case for 10 s	300	$^\circ\text{C}$
$T_{SOLD}$	Plastic body for 10 s	260	$^\circ\text{C}$
$M_d$	Mounting torque (TO-3P)	1.13/10	Nm/lb.in.
$F_c$	Mounting force (PLUS 220)	11...65/2.5...15	N/lb
<b>Weight</b>	TO-3P	6	g
	PLUS220 & PLUS220SMD	5.0	g

TO-3P (IXTQ)

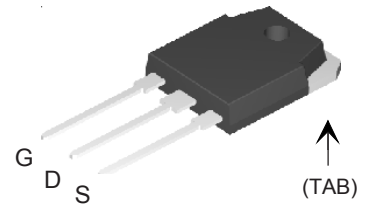

PLUS220 (IXTV)

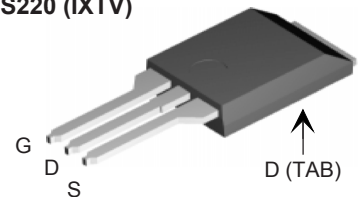

PLUS220SMD (IXTV\_S)

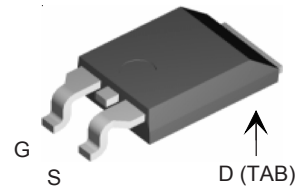

G = Gate      D = Drain  
S = Source    TAB = Drain

Symbol	Test Conditions ( $T_J = 25^\circ\text{C}$ , unless otherwise specified)	Characteristic Values		
		Min.	Typ.	Max.
$BV_{DSS}$	$V_{GS} = 0 \text{ V}$ , $I_D = 250 \mu\text{A}$	600		V
$V_{GS(th)}$	$V_{DS} = V_{GS}$ , $I_D = 250 \mu\text{A}$	3.0		5.5 V
$I_{GSS}$	$V_{GS} = \pm 30 \text{ V}_{DC}$ , $V_{DS} = 0$			$\pm 100 \text{ nA}$
$I_{DSS}$	$V_{DS} = V_{DSS}$ , $V_{GS} = 0 \text{ V}$ , $T_J = 125^\circ\text{C}$			25 $\mu\text{A}$ 250 $\mu\text{A}$
$R_{DS(on)}$	$V_{GS} = 10 \text{ V}$ , $I_D = 0.5 I_{D25}$ Pulse test, $t \leq 300 \mu\text{s}$ , duty cycle $d \leq 2\%$			350 $\text{m}\Omega$

## Features

- † International standard packages
- † Unclamped Inductive Switching (UIS) rated
- † Low package inductance
- easy to drive and to protect

## Advantages

- † Easy to mount
- † Space savings
- † High power density

Symbol	Test Conditions	Characteristic Values		
		Min.	Typ.	Max.
$g_{fs}$	$V_{DS} = 20\text{ V}; I_D = 0.5 I_{D25}$ , pulse test	15	21	S
$C_{iss}$	$V_{GS} = 0\text{ V}, V_{DS} = 25\text{ V}, f = 1\text{ MHz}$		3600	pF
$C_{oss}$			305	pF
$C_{rss}$			38	pF
$t_{d(on)}$	$V_{GS} = 10\text{ V}, V_{DS} = 0.5 V_{DSS}, I_D = I_{D25}$ $R_G = 4\ \Omega$ (External)		20	ns
$t_r$			20	ns
$t_{d(off)}$			60	ns
$t_f$			23	ns
$Q_{g(on)}$	$V_{GS} = 10\text{ V}, V_{DS} = 0.5 V_{DSS}, I_D = 0.5 I_{D25}$		62	nC
$Q_{gs}$			20	nC
$Q_{gd}$			25	nC
$R_{thJC}$	(TO-3P)			0.31 °C/W
$R_{thCS}$			0.21	°C/W

**TO-3P (IXTQ) Outline**

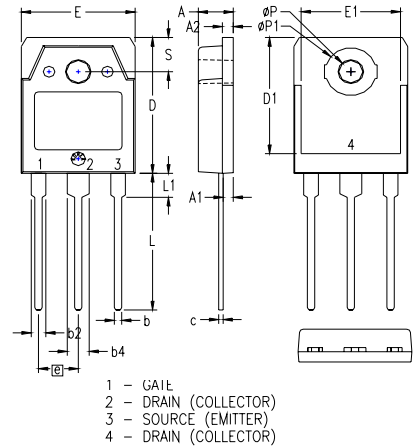

SYM	INCHES		MILLIMETERS	
	MIN	MAX	MIN	MAX
A	.185	.193	4.70	4.90
A1	.051	.059	1.30	1.50
A2	.057	.065	1.45	1.65
b	.035	.045	0.90	1.15
b2	.075	.087	1.90	2.20
b4	.114	.126	2.90	3.20
c	.022	.031	0.55	0.80
D	.780	.799	19.80	20.30
D1	.665	.677	16.90	17.20
E	.610	.622	15.50	15.80
E1	.531	.539	13.50	13.70
e	.215 BSC		5.45 BSC	
L	.779	.795	19.80	20.20
L1	.134	.142	3.40	3.60
ØP1	.126	.134	3.20	3.40
S	.272	.280	6.90	7.10
S	.193	.201	4.90	5.10

**Source-Drain Diode**

Symbol	Test Conditions	Characteristic Values		
		Min.	Typ.	Max.
$I_S$	$V_{GS} = 0\text{ V}$			22 A
$I_{SM}$	Repetitive			66 A
$V_{SD}$	$I_F = I_S, V_{GS} = 0\text{ V}$ , Pulse test, $t \leq 300\ \mu\text{s}$ , duty cycle $d \leq 2\%$			1.5 V
$t_{rr}$	$I_F = 22\text{ A}, -di/dt = 100\text{ A}/\mu\text{s}$ $V_R = 100\text{ V}, V_{GS} = 0\text{ V}$		500	ns
$Q_{RM}$			4.0	$\mu\text{C}$

**PLUS220 (IXTV) Outline**

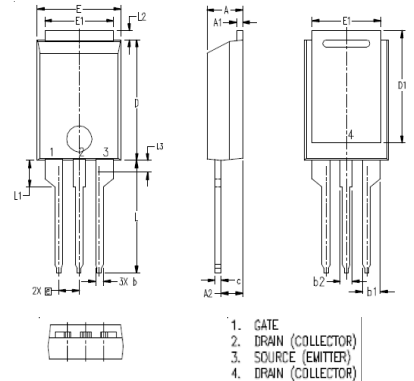

SYM	INCHES		MILLIMETER	
	MIN	MAX	MIN	MAX
A	.169	.185	4.30	4.70
A1	.028	.035	0.70	0.90
A2	.098	.118	2.50	3.00
b	.035	.047	0.90	1.20
b1	.080	.095	2.03	2.41
b2	.054	.064	1.37	1.63
c	.028	.035	0.70	0.90
D	.551	.591	14.00	15.00
D1	.512	.539	13.00	13.70
E	.394	.433	10.00	11.00
E1	.331	.346	8.40	8.80
e	.100 BSC		2.54 BSC	
L	.512	.551	13.00	14.00
L1	.118	.138	3.00	3.50
L2	.035	.051	0.90	1.30
L3	.047	.059	1.20	1.50

**PLUS220SMD (IXTV\_S) Outline**

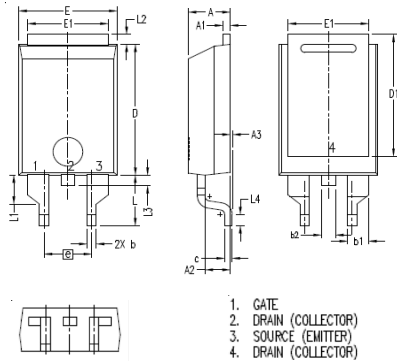

SYM	INCHES		MILLIMETER	
	MIN	MAX	MIN	MAX
A	.169	.185	4.30	4.70
A1	.028	.035	0.70	0.90
A2	.098	.118	2.50	3.00
A3	.000	.010	0.00	0.25
b	.035	.047	0.90	1.20
b1	.080	.095	2.03	2.41
b2	.054	.064	1.37	1.63
c	.028	.035	0.70	0.90
D	.551	.591	14.00	15.00
D1	.512	.539	13.00	13.70
E	.394	.433	10.00	11.00
E1	.331	.346	8.40	8.80
e	.200 BSC		5.08 BSC	
L	.209	.228	5.30	5.80
L1	.118	.138	3.00	3.50
L2	.035	.051	0.90	1.30
L3	.047	.059	1.20	1.50
L4	.039	.059	1.00	1.50

IXYS reserves the right to change limits, test conditions, and dimensions.

IXYS MOSFETs and IGBTs are covered by 4,835,592 4,931,844 5,049,961 5,237,481 6,162,665 6,404,065 B1 6,683,344 6,727,585  
one or more of the following U.S. patents: 4,850,072 5,017,508 5,063,307 5,381,025 6,259,123 B1 6,534,343 6,710,405 B2 6,759,692  
4,881,106 5,034,796 5,187,117 5,486,715 6,306,728 B1 6,583,505 6,710,463 6,771,478 B2

**Fig. 1. Output Characteristics**  
**@ 25°C**

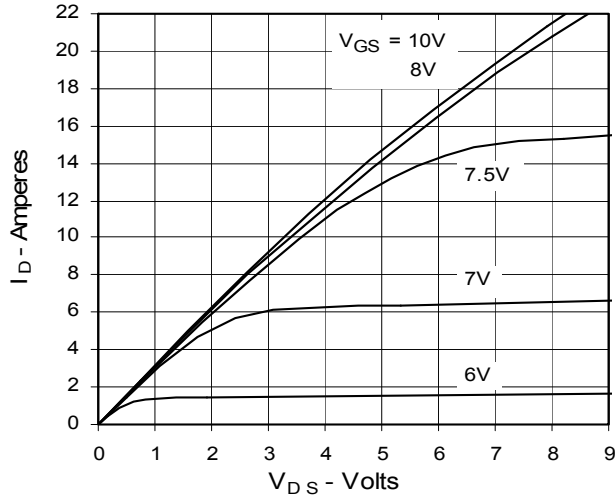

**Fig. 2. Extended Output Characteristics**  
**@ 25°C**

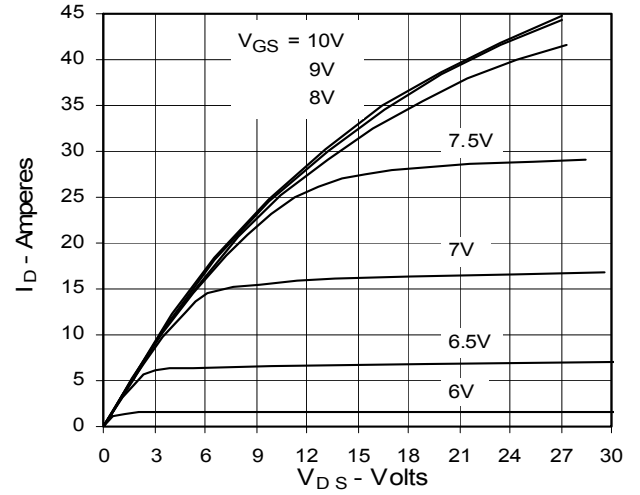

**Fig. 3. Output Characteristics**  
**@ 125°C**

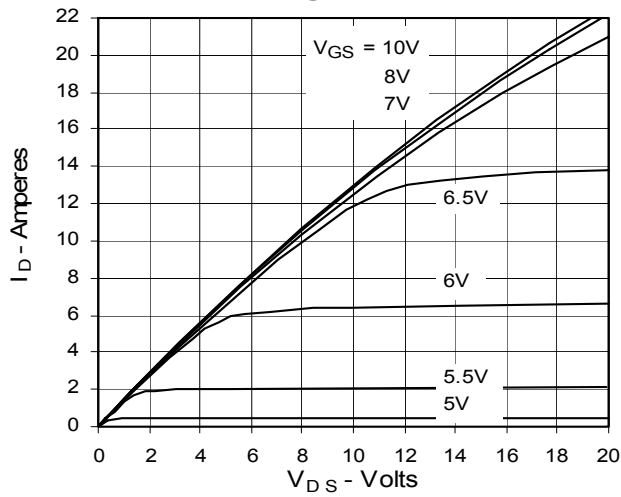

**Fig. 4.  $R_{DS(on)}$  Normalized to 0.5  $I_{D25}$  Value vs. Junction Temperature**

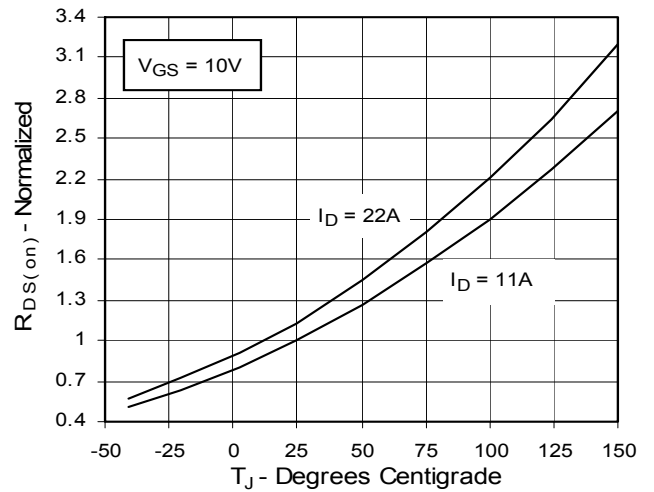

**Fig. 5.  $R_{DS(on)}$  Normalized to 0.5  $I_{D25}$  Value vs.  $I_D$**

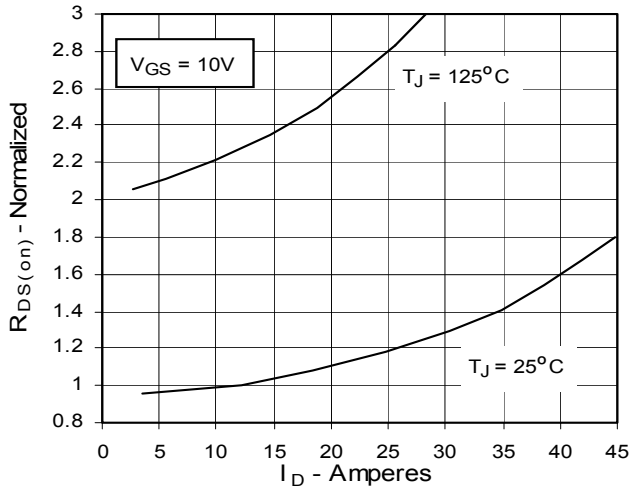

**Fig. 6. Drain Current vs. Case Temperature**

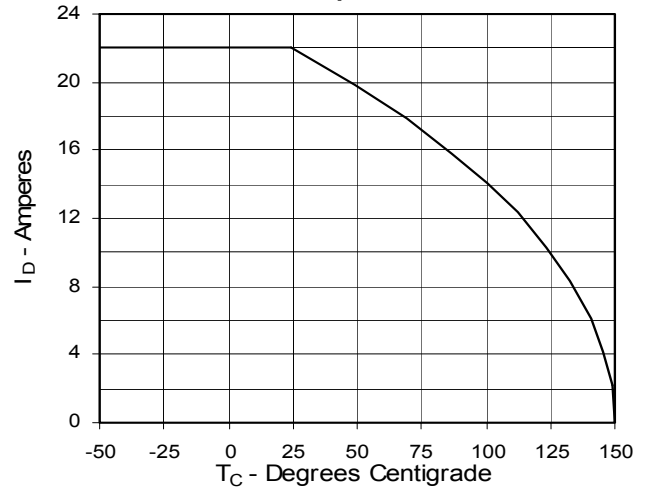

**Fig. 7. Input Admittance**

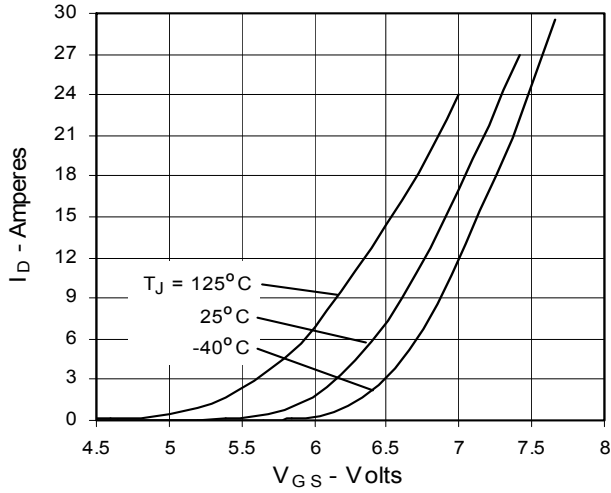

**Fig. 8. Transconductance**

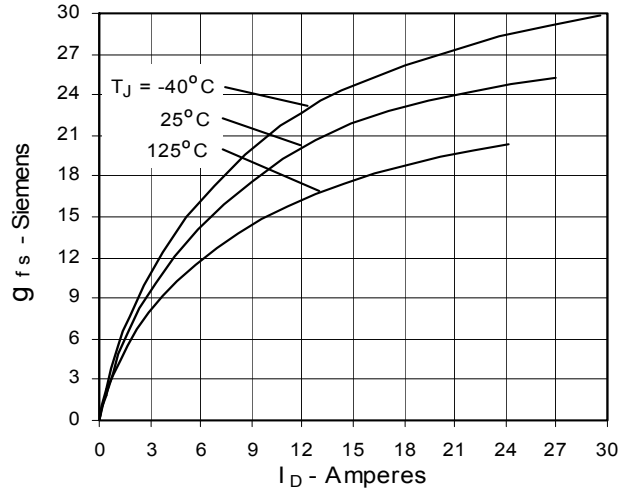

**Fig. 9. Source Current vs. Source-To-Drain Voltage**

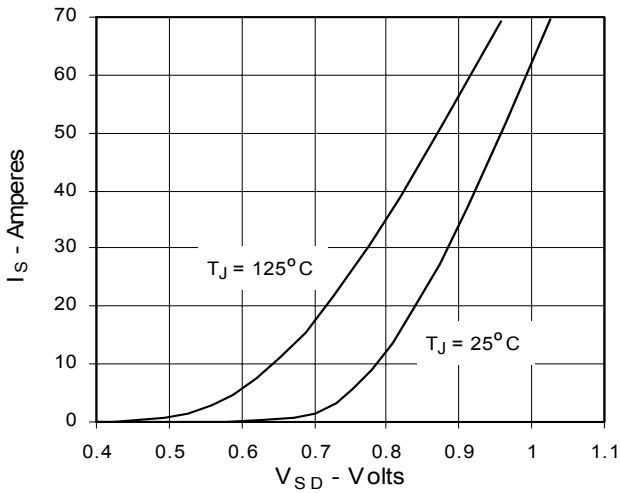

**Fig. 10. Gate Charge**

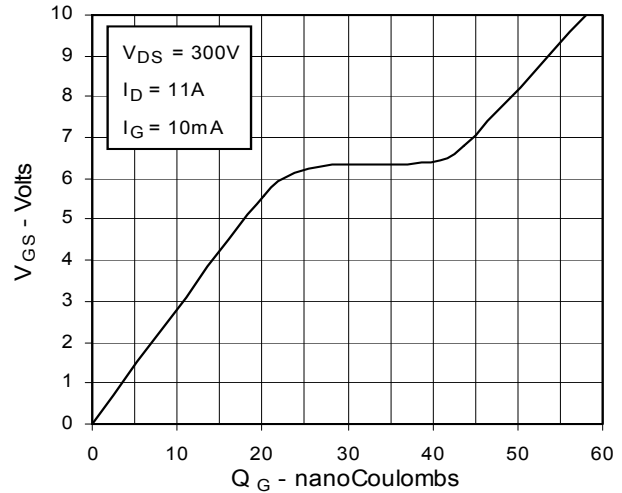

**Fig. 11. Capacitance**

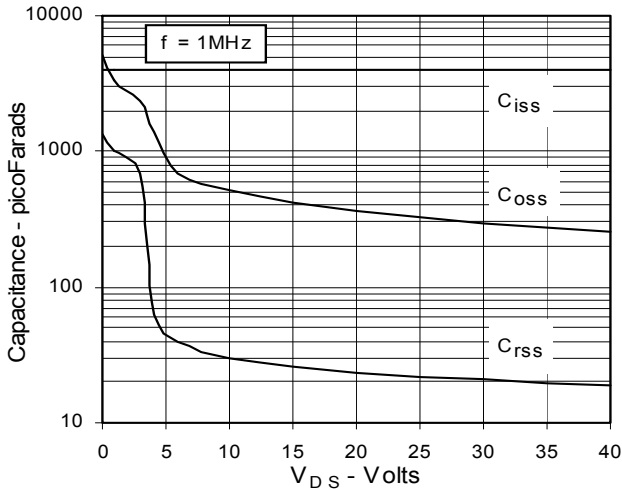

**Fig. 12. Forward-Bias Safe Operating Area**

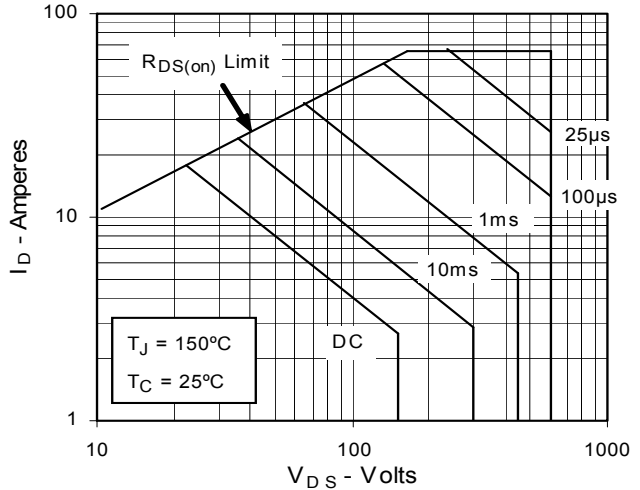
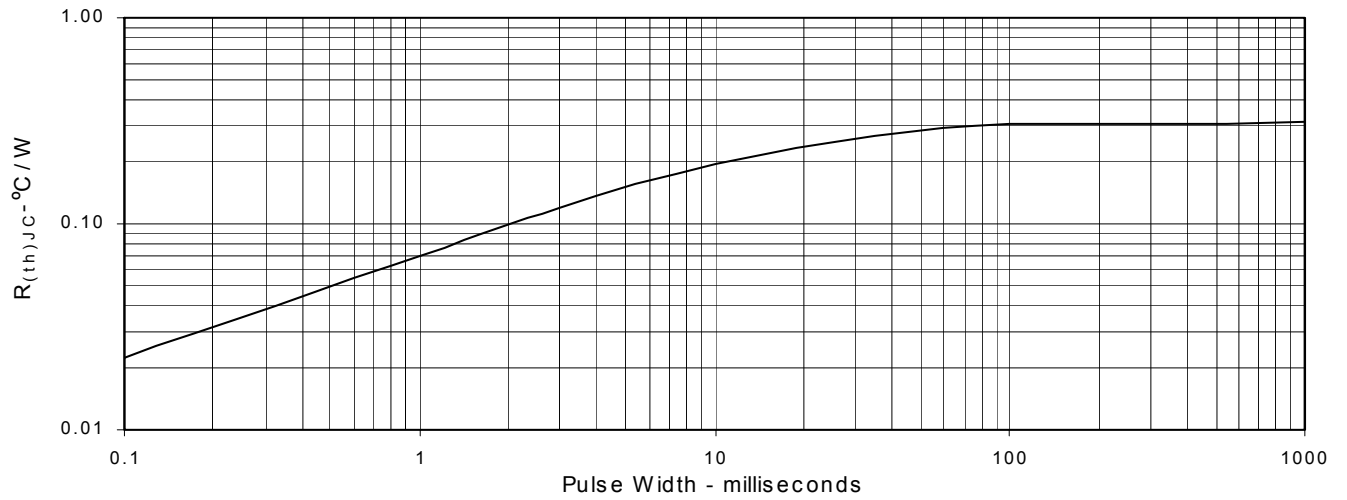

Fig. 13. Maximum Transient Thermal Resistance





---

Disclaimer Notice - Information furnished is believed to be accurate and reliable. However, users should independently evaluate the suitability of and test each product selected for their own applications. Littelfuse products are not designed for, and may not be used in, all applications. Read complete Disclaimer Notice at [www.littelfuse.com/disclaimer-electronics](http://www.littelfuse.com/disclaimer-electronics).