

# Surface Mount 1672.50MHz SAW Filter

AFS20A05-1672.50-T2

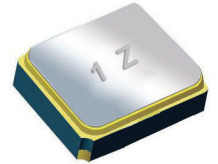

RoHS  
Compliant



2.0 x 1.6 x 0.9 mm

## FEATURES:

- 2.0 x 1.6 x 0.9 mm low profile SMT package
- Low Insertion loss
- Excellent selectivity with high out-of-band rejection

## APPLICATIONS:

- Wireless Communication
- Remote Control
- Cellular Phones

## ELECTRICAL SPECIFICATIONS:

### Maximum Ratings

Item	Value
Input Power Level	+10 dBm max.
DC Permissive Voltage	3.0V DC max.
Operating Temperature Range	-30°C to + 105°C
Storage Temperature Range	-40°C to + 105°C

Parameters	Minimum	Typical	Maximum	Units	Notes
Center Frequency ( $f_c$ )		1672.50		MHz	
Insertion Loss (IL)		1.60	2.20	dB	(1670 ~ 1675MHz)
3-dB Bandwidth		2.00		MHz	
Amplitude Ripple		0.20	0.50	dB	(1670 ~ 1675MHz)
Worst-Case Input / Output Return Loss		17.70	10.88	dB	(1670 ~ 1675MHz)
Stop-band Attenuation (Referenced to 0.0 dB)	33	35.5		dB	(824 ~ 849MHz)
	30	35.5			(849 ~ 1500MHz)
	36	40			(1850 ~ 1910MHz)
	25	41			(1930 ~ 1990MHz)
	25	33			(2180 ~ 4000MHz)
Source Impedance ( $Z_s$ )		50		$\Omega$	See note # 1
Load Impedance ( $Z_L$ )		50		$\Omega$	See note # 1

**Note #1:** No matching network required for operation into 50 $\Omega$ 's

## TEST CIRCUIT:

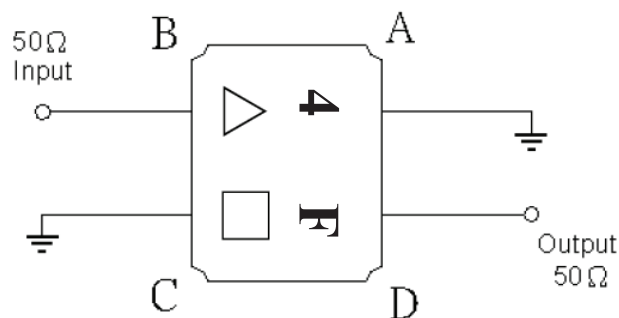

# Surface Mount 1672.50MHz SAW Filter

AFS20A05-1672.50-T2



RoHS  
Compliant

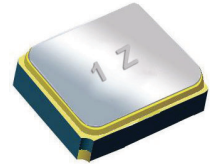

2.0 x 1.6 x 0.9 mm

## OUTLINE DIMENSIONS:

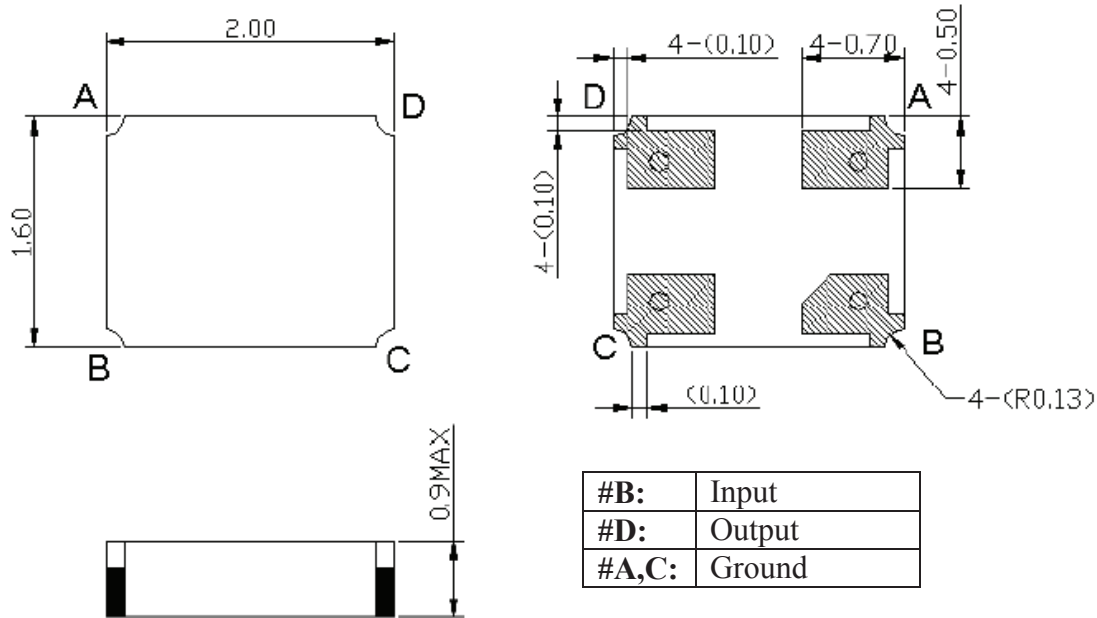

\*All Dimensions are in mm

## Recommended Land Pattern:

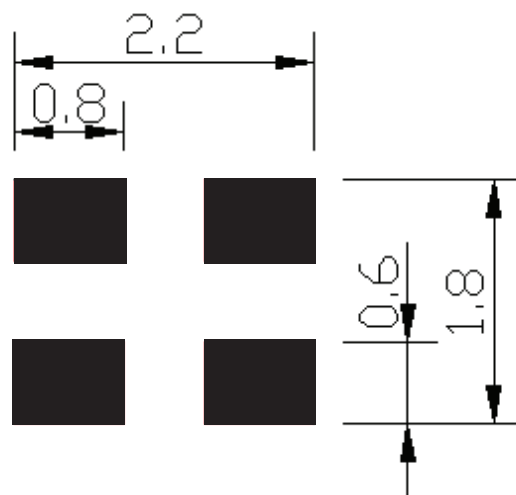

# Surface Mount 1672.50MHz SAW Filter

AFS20A05-1672.50-T2

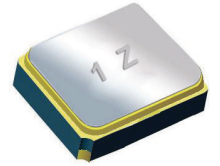

2.0 x 1.6 x 0.9 mm

## FREQUENCY CHARACTERISTICS:

### Filter Frequency Response (Narrowband)

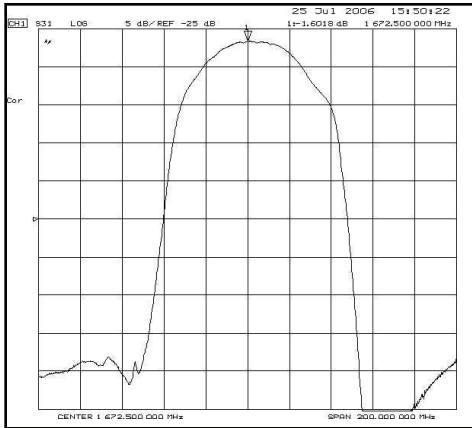

### Filter Frequency Response (Wideband)

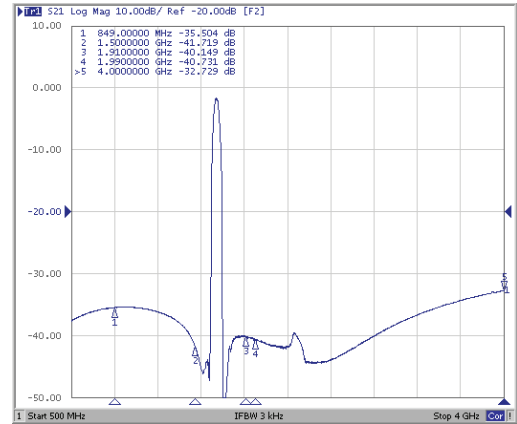

## REFLECTION FUNCTIONS:

### S11

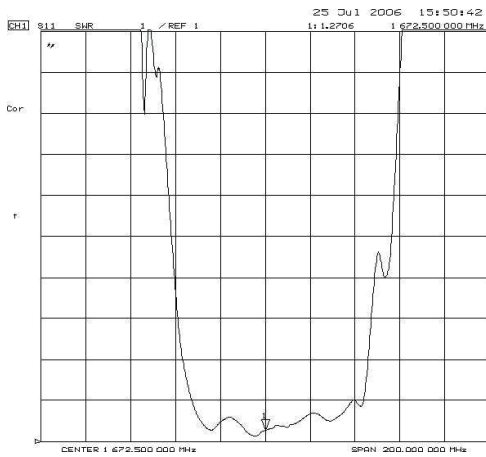

### S22

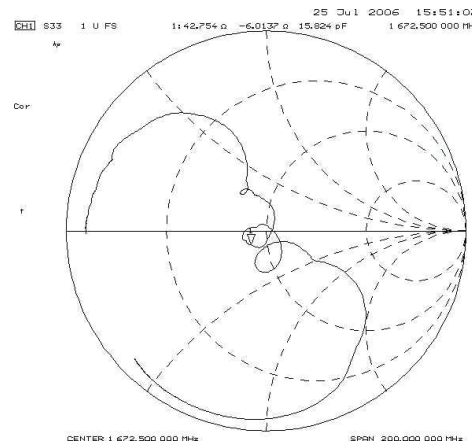
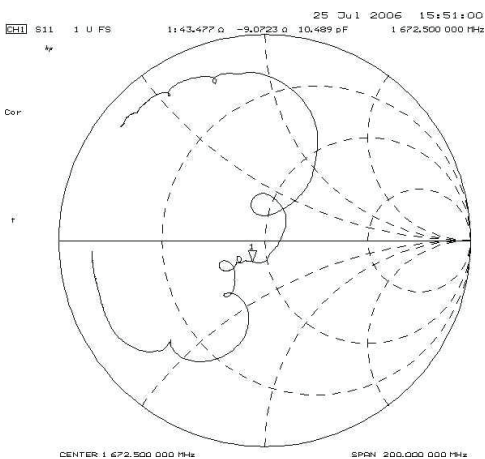
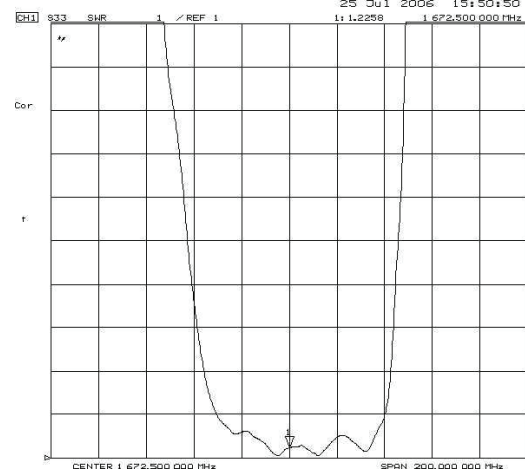

Detail S-parameter information (.s2p file) available upon request

ABRACON IS  
ISO 9001:2008  
CERTIFIED



Visit [www.abracon.com](http://www.abracon.com) for Terms & Conditions of Sale  
30332 Esperanza, Rancho Santa Margarita, California 92688  
tel 949-546-8000 | fax 949-546-8001 | [www.abracon.com](http://www.abracon.com)

Revised: 07.24.12

# Surface Mount 1672.50MHz SAW Filter

AFS20A05-1672.50-T2



RoHS  
Compliant

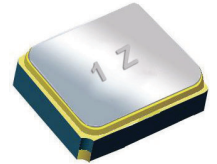

2.0 x 1.6 x 0.9 mm

## REFLOW PROFILE:

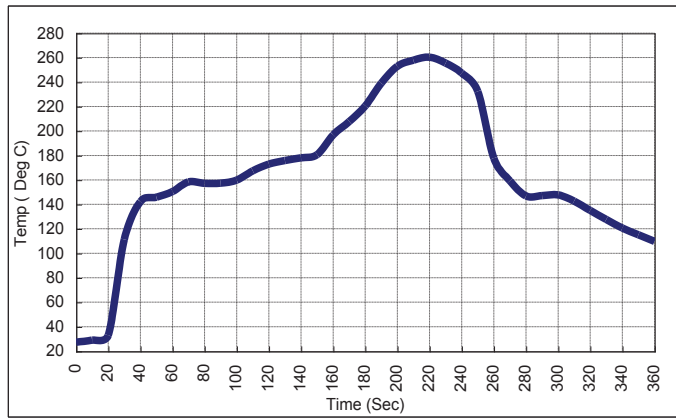

## PACKAGING: 2000 Units/Reel

Reel Count : 7" = 2k units

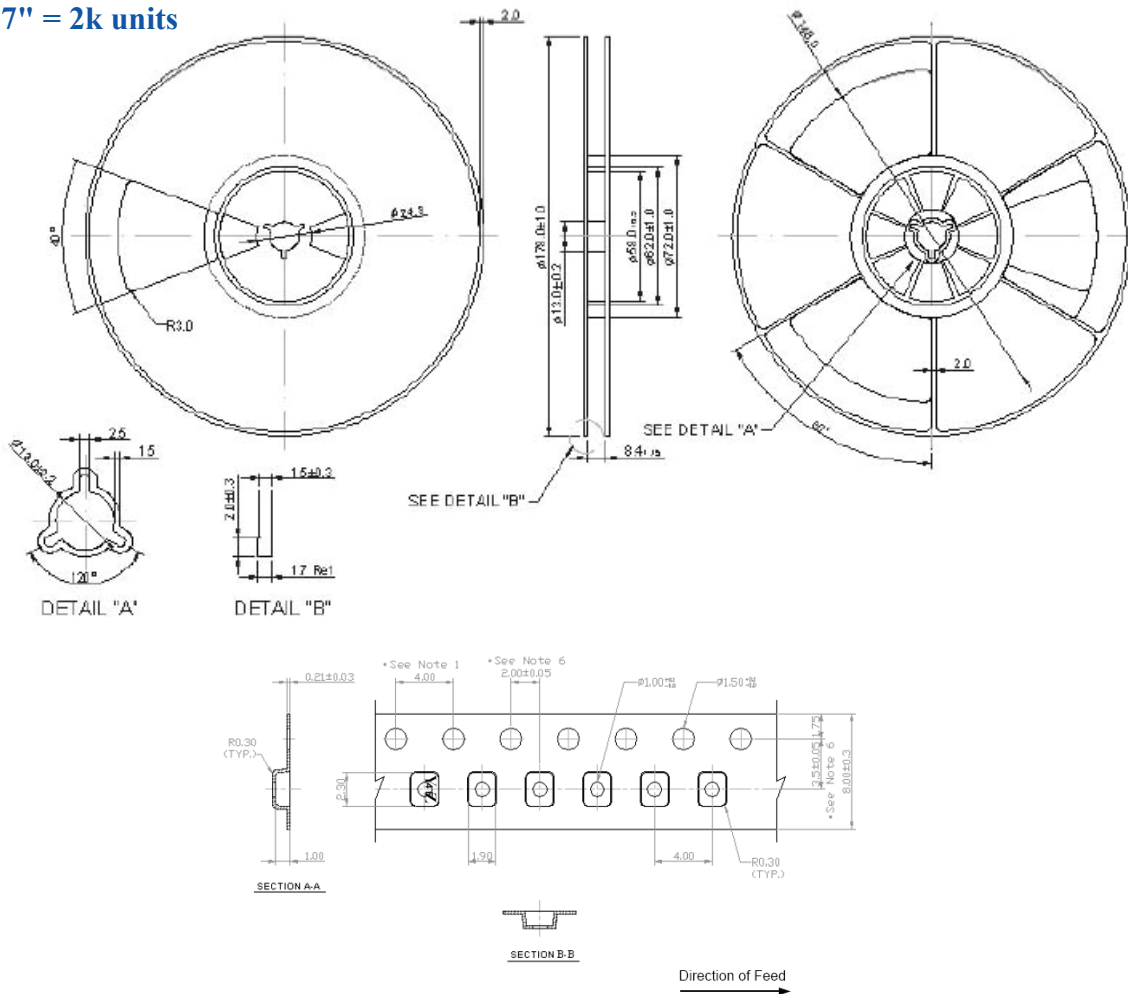

**ATTENTION:** Abracon Corporation's products are COTS – Commercial-Off-The-Shelf products; suitable for Commercial, Industrial and, where designated, Automotive Applications. Abracon's products are not specifically designed for Military, Aviation, Aerospace, Life-dependant Medical applications or any application requiring high reliability where component failure could result in loss of life and/or property. For applications requiring high reliability and/or presenting an extreme operating environment, written consent and authorization from Abracon Corporation is required. Please contact Abracon Corporation for more information.

ABRACON IS  
ISO 9001:2008  
CERTIFIED



Visit [www.abracon.com](http://www.abracon.com) for Terms & Conditions of Sale  
30332 Esperanza, Rancho Santa Margarita, California 92688  
tel 949-546-8000 | fax 949-546-8001 | [www.abracon.com](http://www.abracon.com)

Revised: 07.24.12