

(0.45)
(CARD POSHED POSITION)
(1.25)
(CARD LOCKED POSITION)
(5.25)
(CARD EJECTED POSITION)

- NOTES:
1. MATERIALS: HOUSING, CAM, DUMMY CARD: HIGH TEMP THERMOPLASTIC, UL94V-0, BLACK
TERMINAL, DETECT PIN: COPPER ALLOY
METAL SHELL, COIL SPRING, CAM PIN: STAINLESS STEEL
 2. FINISHES: 0.76µm MIN GOLD ON CONTACT AREA OVER 1.27µm NICKEL UNDERPLATE.
2.54µm MIN MATTE TIN ON SOLDER TAIL AREA OVER 1.27µm NICKEL UNDERPLATE.
GOLD FLASH ON SHELL SOLDER TAB OVER 1.27µm NICKEL UNDERPLATE.
 3. PRODUCT SPECIFICATION: PS-78526-001
 4. PACKAGING SPECIFICATION: PK-78526-001
 5. MOLEX LOGO LOCATED APPROXIMATELY AS SHOWN.
- △ MINIMUM KEEP OUT ZONE FROM TOP SURFACE OF SHELL DURING INSERTION AND WITHDRAWAL OF SIM CARD
▽ DATE CODE PRINTING: XX XX X
DAY
WEEK
YEAR

HALOGEN FREE

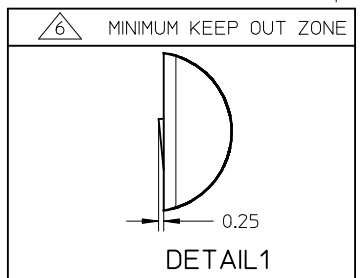

785260011	W/O DUMMY CARD
785260001	WIHT DUMMY CARD
ASSEMBLY P/N.	DESCRIPTION

ADD NEW P/N	2012/07/31
EC NO: S2012-0960	2012/08/27
DRWN: JZENG	2012/08/27
CHKD: JTAN02	2012/09/05
APPR: KHL JM	
A8	

QUALITY SYMBOLS	DESCRIPTION
▽ _A =0	
▽ _B =0	
▽ _C =0	

GENERAL TOLERANCES (UNLESS SPECIFIED)	
	mm INCH
4 PLACES	± --- ± ---
3 PLACES	± --- ± ---
2 PLACES	± 0.25 ± ---
1 PLACE	± --- ± ---
ANGULAR ± 3 °	
DRAFT WHERE APPLICABLE MUST REMAIN WITHIN DIMENSIONS	

DIMENSION STYLE	
MM ONLY	
DRAWN BY	DATE
CGOH	2009/07/17
CHECKED BY	DATE
JTAN02	2009/08/17
APPROVED BY	DATE
BOKOK	2010/11/11
MATERIAL NO.	
SEE TABLE	
SIZE	
A3	

SCALE	DESIGN UNITS	THIRD ANGLE PROJECTION
NTS	METRIC	
TITLE		
SIM CARD CONNECTOR PUSH PUSH TYPE HEIGHT 1.5MM		
MOLEX INCORPORATED		
MATERIAL NO.	DOCUMENT NO.	SHEET NO.
	SD-78526-001	1 OF 3
THIS DRAWING CONTAINS INFORMATION THAT IS PROPRIETARY TO MOLEX INCORPORATED AND SHOULD NOT BE USED WITHOUT WRITTEN PERMISSION		

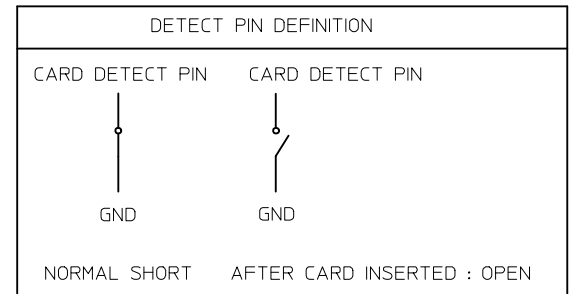
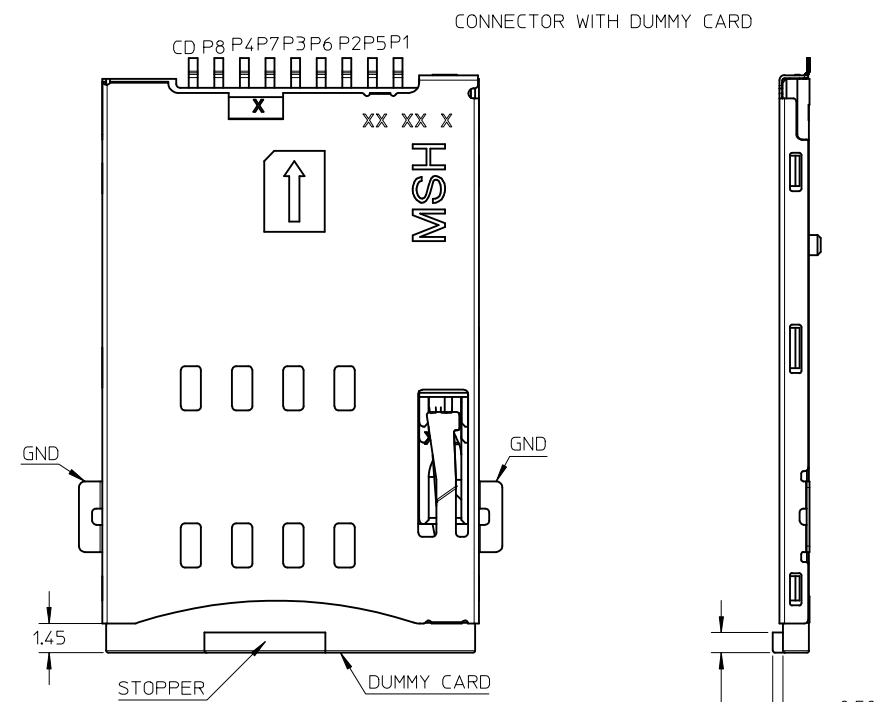
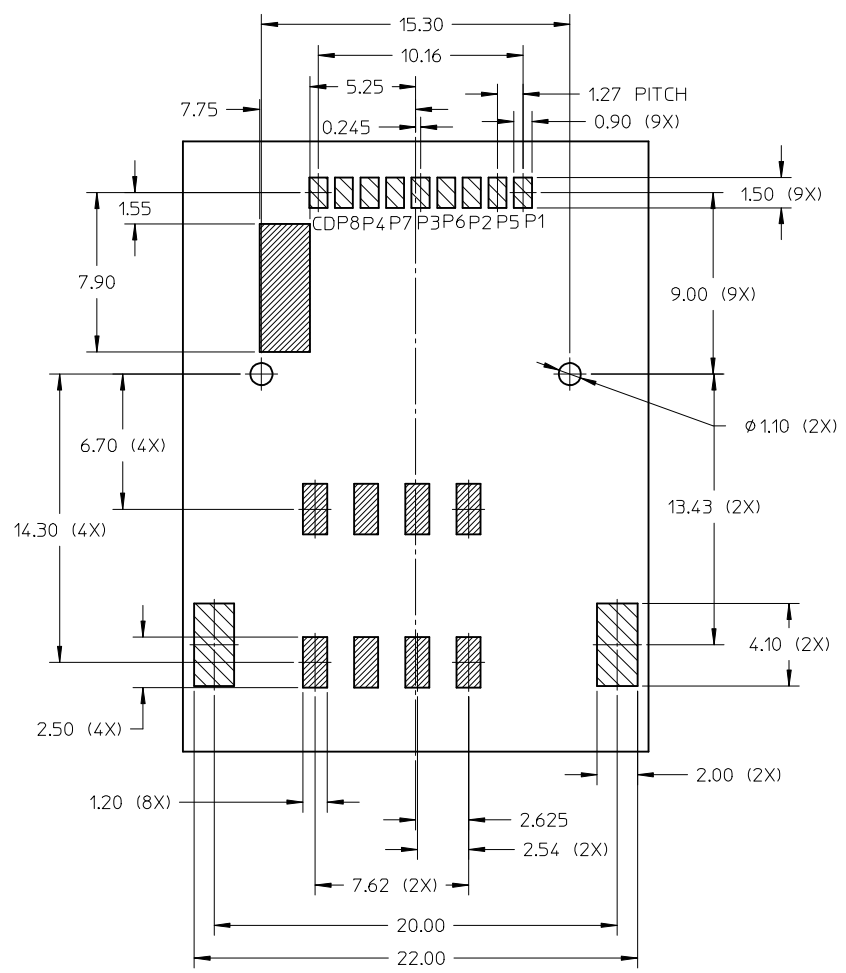

CIRCUIT TRACE KEEP OUT AREA

SOLDERING PAD AREA

SEE SHEET 1 EC NO: S2012-0960 DRWN: JZENG CHKD: JTAN02 APPR: KHL JM	2012/07/31 2012/08/27 2012/09/05	QUALITY SYMBOLS $F_A=0$ $F_G=0$ $F_P=0$	GENERAL TOLERANCES (UNLESS SPECIFIED) mm INCH 4 PLACES ± --- ± --- 3 PLACES ± --- ± --- 2 PLACES ± 0.25 ± --- 1 PLACE ± --- ± --- ANGULAR ± 3 °	DIMENSION STYLE MM ONLY DRAWN BY: CGOH DATE: 2009/07/17 CHECKED BY: JTAN02 DATE: 2009/08/17 APPROVED BY: BOKOK DATE: 2010/11/11	SCALE: NTS DESIGN UNITS: METRIC THIRD ANGLE PROJECTION	TITLE: SIM CARD CONNECTOR PUSH PUSH TYPE HEIGHT 1.5MM MOLEX INCORPORATED
	DRAFT WHERE APPLICABLE MUST REMAIN WITHIN DIMENSIONS	SEE SHEET 1	MATERIAL NO. DOCUMENT NO.	SHEET NO.		
	SIZE: A3	THIS DRAWING CONTAINS INFORMATION THAT IS PROPRIETARY TO MOLEX INCORPORATED AND SHOULD NOT BE USED WITHOUT WRITTEN PERMISSION				
	A8	SD-78526-001	2 OF 3			

10 9 8 7 6 5 4 3 2 1

TAPE AND REEL PACKING

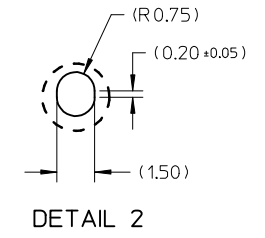
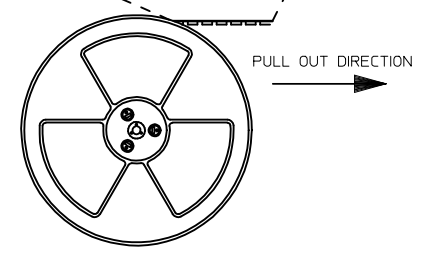
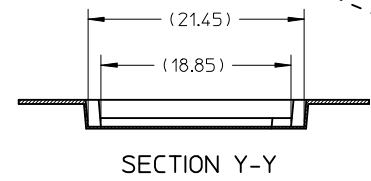
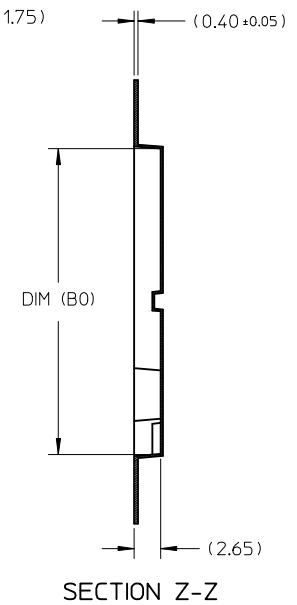
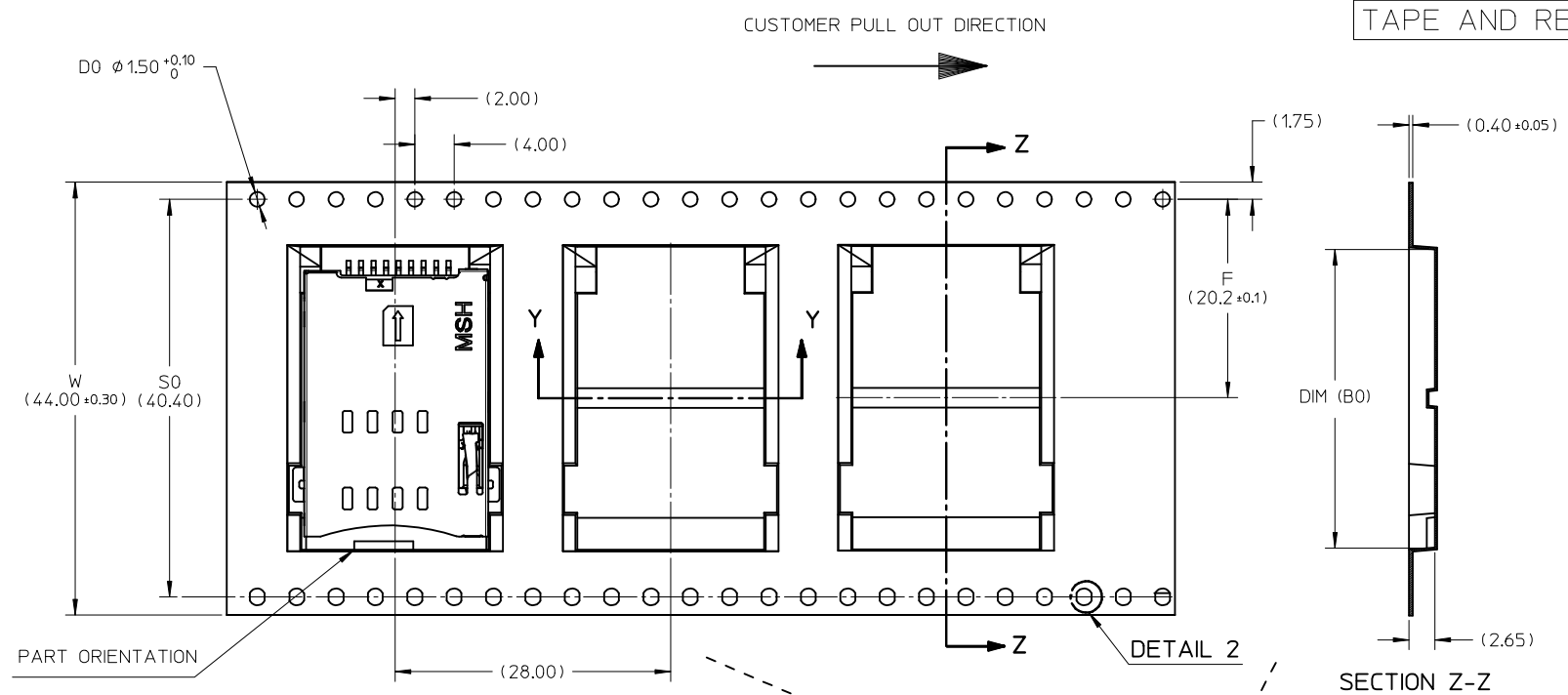

NOTES:

1. LEADER AND TRAILER TAPE

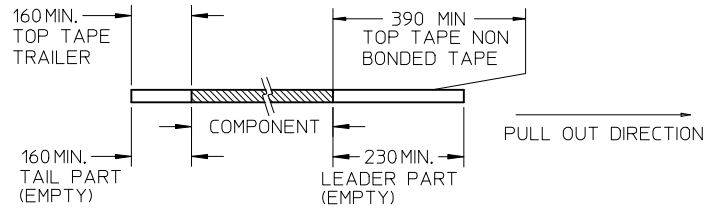

2. PEELING OFF FORCE OF THE TOP TAPE: 10 - 130gf. (PEELING DIRECTION AS SHOWN IN FOLLOWING FIGURE)

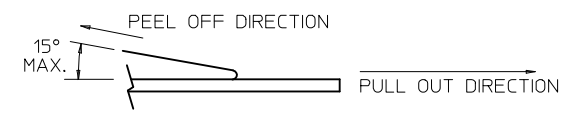

- 3. TAPE AND REEL SPECIFICATION IS AS PER EIA-481.
- 4. TAPE AND REEL QUANTITY : 600 PCS/ REEL.
- 5. THE TAPE IS TREATED FOR ANTI-STATIC.

785260011	28.50	477995127
785260001	30.70	887962916
ASSEMBLY P/N	DIM (B0)	PACKAGING P/N

SEE SHEET 1 EC NO: S2012-0960 DRWN: JZENG CHKD: JTAN02 APPR: KHLIM	DESCRIPTION A8	QUALITY SYMBOLS	GENERAL TOLERANCES (UNLESS SPECIFIED)		DIMENSION STYLE MM ONLY		SCALE NTS	DESIGN UNITS METRIC	THIRD ANGLE PROJECTION		
		$\nabla_A = 0$	mm	INCH	DRAWN BY CGOH	DATE 2009/07/17	TITLE SIM CARD CONNECTOR PUSH PUSH TYPE HEIGHT 1.5MM MOLEX INCORPORATED DOCUMENT NO. SD-78526-001 SHEET NO. 3 OF 3				
		$\nabla_C = 0$	4 PLACES ± ---	± ---	CHECKED BY JTAN02	DATE 2009/08/17					
		$\nabla_B = 0$	3 PLACES ± ---	± ---	APPROVED BY BOKOK	DATE 2010/11/11					
	2 PLACES ± 0.25	± ---	MATERIAL NO.								
		1 PLACE ± ---	± ---	ANGULAR ± 3 °		DRAFT WHERE APPLICABLE MUST REMAIN WITHIN DIMENSIONS					
		SIZE A3		THIS DRAWING CONTAINS INFORMATION THAT IS PROPRIETARY TO MOLEX INCORPORATED AND SHOULD NOT BE USED WITHOUT WRITTEN PERMISSION							

9 8 7 6 5 4 3 2 1

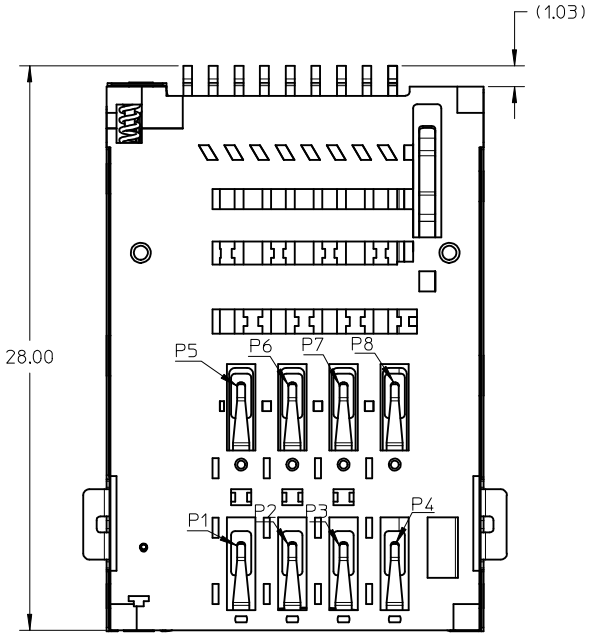
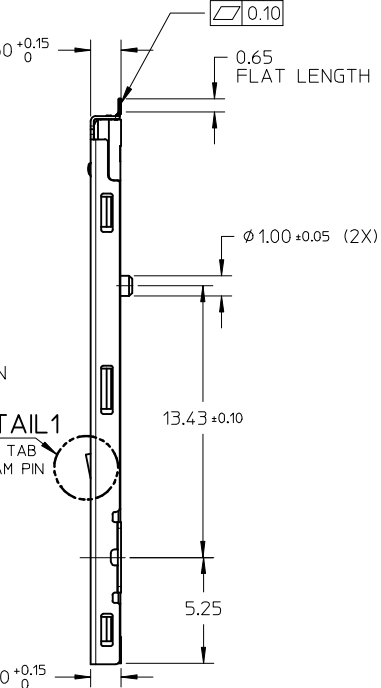
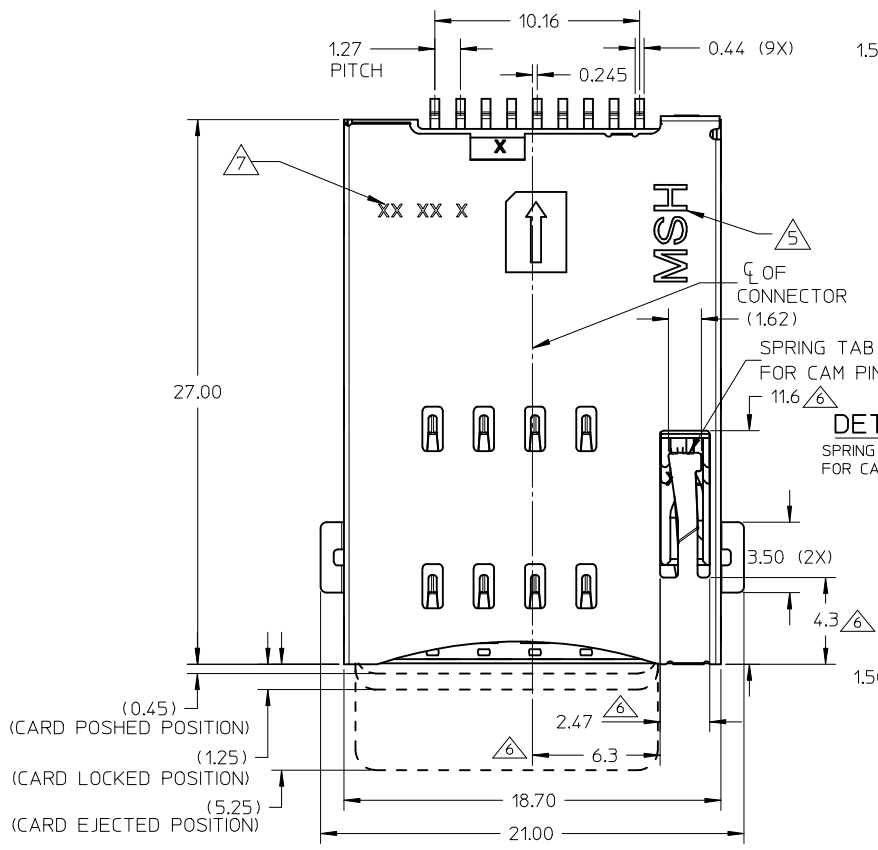

- NOTES:
- MATERIALS: HOUSING, CAM, DUMMY CARD: HIGH TEMP THERMOPLASTIC, UL94V-0, BLACK
 TERMINAL, DETECT PIN: COPPER ALLOY
 METAL SHELL, COIL SPRING, CAM PIN: STAINLESS STEEL
 - FINISHES: 0.76µm MIN GOLD ON CONTACT AREA OVER 1.27µm NICKEL UNDERPLATE.
 2.54µm MIN MATTE TIN ON SOLDER TAIL AREA OVER 1.27µm NICKEL UNDERPLATE.
 GOLD FLASH ON SHELL SOLDER TAB OVER 1.27µm NICKEL UNDERPLATE.
 - PRODUCT SPECIFICATION: PS-78526-001
 - PACKAGING SPECIFICATION: PK-78526-001
 - MOLEX LOGO LOCATED APPROXIMATELY AS SHOWN.
- △ MINIMUM KEEP OUT ZONE FROM TOP SURFACE OF SHELL DURING INSERTION AND WITHDRAWAL OF SIM CARD
 ▽ DATE CODE PRINTING: XX XX X
 DAY
 WEEK
 YEAR

HALOGEN FREE

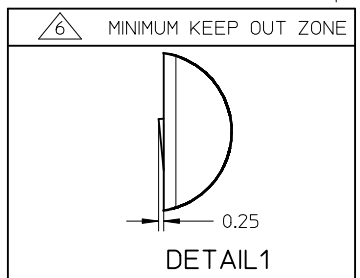
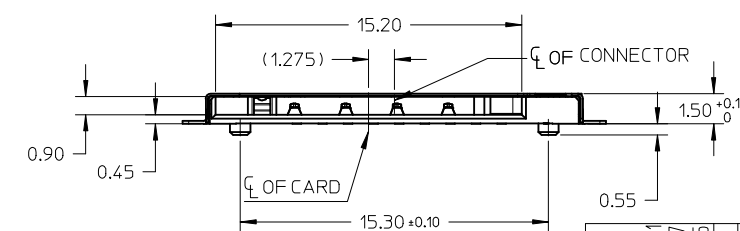

785260011	W/O DUMMY CARD
785260001	WIHT DUMMY CARD
ASSEMBLY P/N.	DESCRIPTION

ADD NEW P/N	DESCRIPTION
EC NO: S2012-0960	2012/07/31
DRWN: JZENG	2012/08/27
CHKD: JTAN02	2012/09/05
APPR: KHL JM	
A8	

QUALITY SYMBOLS	GENERAL TOLERANCES (UNLESS SPECIFIED)	
	mm	INCH
$F_A=0$	4 PLACES ± ---	± ---
$F_B=0$	3 PLACES ± ---	± ---
$F_C=0$	2 PLACES ± 0.25	± ---
$F_D=0$	1 PLACE ± ---	± ---
	ANGULAR ± 3 °	
DRAFT WHERE APPLICABLE MUST REMAIN WITHIN DIMENSIONS		

DIMENSION STYLE	
MM ONLY	
DRAWN BY	DATE
CGOH	2009/07/17
CHECKED BY	DATE
JTAN02	2009/08/17
APPROVED BY	DATE
BOKOK	2010/11/11

SCALE	DESIGN UNITS	THIRD ANGLE PROJECTION
NTS	METRIC	
TITLE		
SIM CARD CONNECTOR PUSH PUSH TYPE HEIGHT 1.5MM		
MOLEX INCORPORATED		
MATERIAL NO.	DOCUMENT NO.	SHEET NO.
SEE TABLE	SD-78526-001	1 OF 3
THIS DRAWING CONTAINS INFORMATION THAT IS PROPRIETARY TO MOLEX INCORPORATED AND SHOULD NOT BE USED WITHOUT WRITTEN PERMISSION		

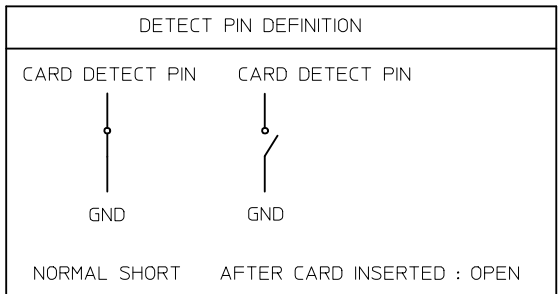
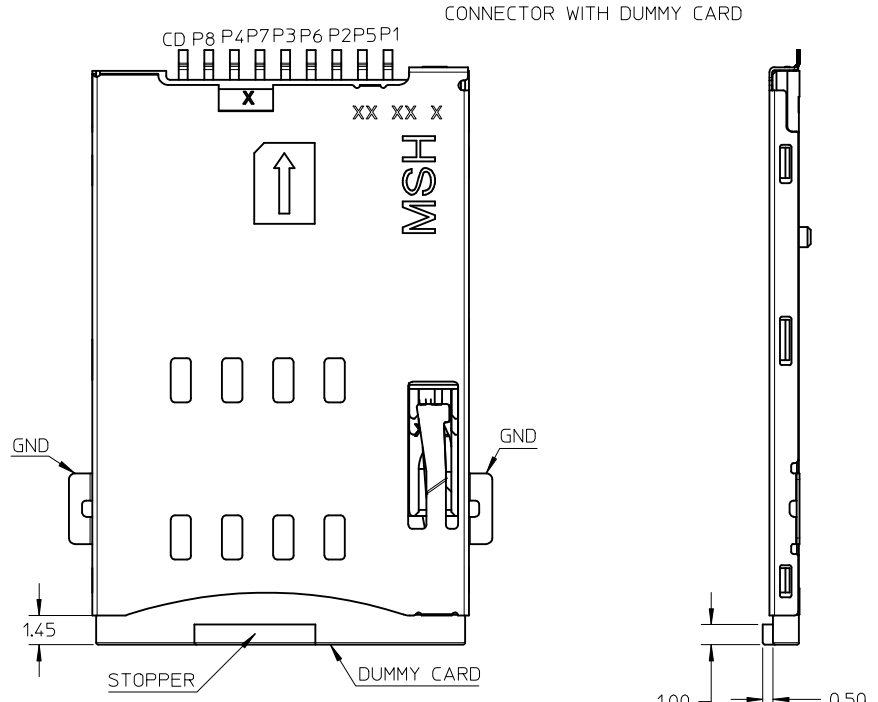
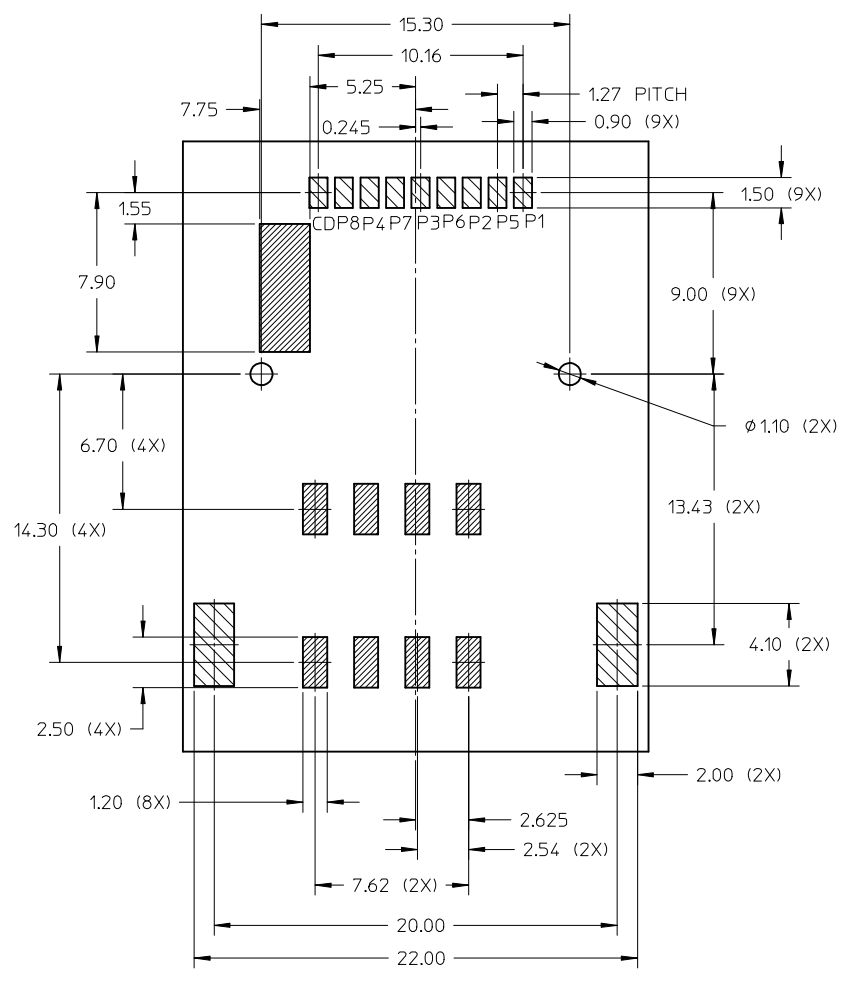

CIRCUIT TRACE KEEP OUT AREA

SOLDERING PAD AREA

SEE SHEET 1 EC NO: S2012-0960 DRWN: JZENG CHKD: JTAN02 APPR: KHL JM	2012/07/31 2012/08/27 2012/09/05	QUALITY SYMBOLS $F_A=0$ $F_G=0$ $F_P=0$	GENERAL TOLERANCES (UNLESS SPECIFIED) mm INCH	DIMENSION STYLE MM ONLY	SCALE NTS	DESIGN UNITS METRIC	THIRD ANGLE PROJECTION	
	4 PLACES ± --- ± --- 3 PLACES ± --- ± --- 2 PLACES ± 0.25 ± --- 1 PLACE ± --- ± ---	DRAWN BY: CGOH CHECKED BY: JTAN02 APPROVED BY: BOKOK	DATE: 2009/07/17 DATE: 2009/08/17 DATE: 2010/11/11	ANGULAR ± 3 °	TITLE: SIM CARD CONNECTOR PUSH PUSH TYPE HEIGHT 1.5MM	MATERIAL NO.	DOCUMENT NO.	SHEET NO.
	DRAFT WHERE APPLICABLE MUST REMAIN WITHIN DIMENSIONS	SEE SHEET 1	MOLEX INCORPORATED	SD-78526-001	2 OF 3	THIS DRAWING CONTAINS INFORMATION THAT IS PROPRIETARY TO MOLEX INCORPORATED AND SHOULD NOT BE USED WITHOUT WRITTEN PERMISSION		
	A8	A3						

10 9 8 7 6 5 4 3 2 1

TAPE AND REEL PACKING

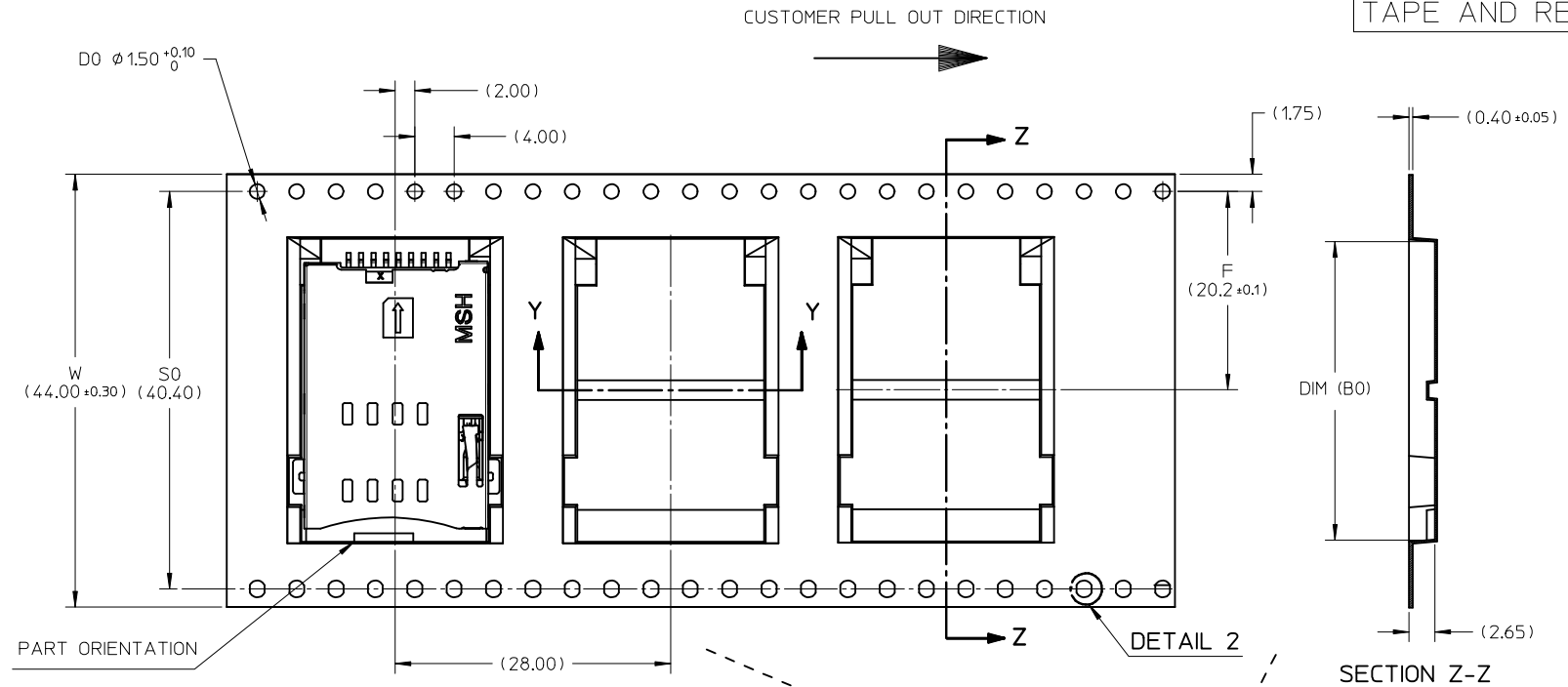

PART ORIENTATION

DETAIL 2

SECTION Z-Z

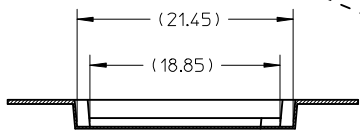

SECTION Y-Y

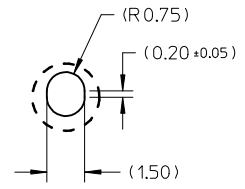
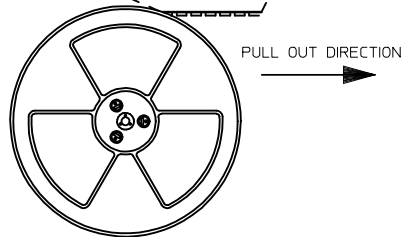

DETAIL 2

NOTES:

1. LEADER AND TRAILER TAPE

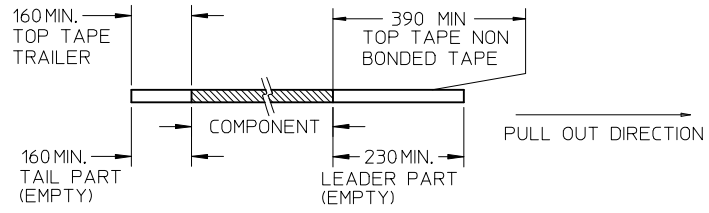

2. PEELING OFF FORCE OF THE TOP TAPE: 10 - 130gf. (PEELING DIRECTION AS SHOWN IN FOLLOWING FIGURE)

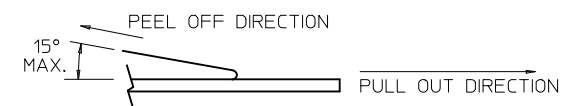

- 3. TAPE AND REEL SPECIFICATION IS AS PER EIA-481.
- 4. TAPE AND REEL QUANTITY : 600 PCS/ REEL.
- 5. THE TAPE IS TREATED FOR ANTI-STATIC.

785260011	28.50	477995127
785260001	30.70	887962916
ASSEMBLY P/N	DIM (B0)	PACKAGING P/N

SEE SHEET 1 EC NO: S2012-0960 DRWN: JZENG CHKD: JTAN02 APPR: KHLIM	DESCRIPTION A8	QUALITY SYMBOLS	GENERAL TOLERANCES (UNLESS SPECIFIED)		DIMENSION STYLE MM ONLY		SCALE NTS	DESIGN UNITS METRIC	THIRD ANGLE PROJECTION		
		$F_A=0$	mm	INCH	DRAWN BY CGOH	DATE 2009/07/17	TITLE SIM CARD CONNECTOR PUSH PUSH TYPE HEIGHT 1.5MM				
		$F_C=0$	4 PLACES ± --- ± ---	3 PLACES ± --- ± ---	CHECKED BY JTAN02	DATE 2009/08/17	MOLEX INCORPORATED				
		$F_P=0$	2 PLACES ± 0.25 ± ---	1 PLACE ± --- ± ---	APPROVED BY BOKOK	DATE 2010/11/11	DOCUMENT NO. SD-78526-001				
ANGULAR ± 3 °			DRAFT WHERE APPLICABLE MUST REMAIN WITHIN DIMENSIONS		SEE TABLE		SHEET NO. 3 OF 3		THIS DRAWING CONTAINS INFORMATION THAT IS PROPRIETARY TO MOLEX INCORPORATED AND SHOULD NOT BE USED WITHOUT WRITTEN PERMISSION		

9 8 7 6 5 4 3 2 1