

FEATURES

Qualified for automotive applications

High performance

Temperature accuracy

$\pm 0.5^{\circ}\text{C}$ from -40°C to $+105^{\circ}\text{C}$ (2.7 V to 3.6 V)

$\pm 0.4^{\circ}\text{C}$ from -40°C to $+105^{\circ}\text{C}$ (3.0 V)

16-bit temperature resolution: 0.0078 $^{\circ}\text{C}$

Fast first conversion on power-up of 6 ms

Easy implementation

No temperature calibration/correction required by user

No linearity correction required

Low power

Power saving 1 sample per second (SPS) mode

700 μW typical at 3.3 V in normal mode

7 μW typical at 3.3 V in shutdown mode

Wide operating ranges

Temperature range: -40°C to $+150^{\circ}\text{C}$

Voltage range: 2.7 V to 5.5 V

Programmable interrupts

Critical overtemperature interrupt

Overtemperature/undertemperature interrupt

SPI-compatible interface

8-lead narrow SOIC RoHS-compliant package

APPLICATIONS

Battery management

Climate control and infotainment

Lighting

Powertrain

Thermocouple cold junction compensation

GPS

GENERAL DESCRIPTION

The ADT7311 is a high accuracy digital temperature sensor in a narrow 8-lead SOIC package. It contains a band gap temperature reference and a 16-bit ADC to monitor and digitize the temperature to a 0.0078 $^{\circ}\text{C}$ resolution. The ADC resolution, by default, is set to 13 bits (0.0625 $^{\circ}\text{C}$). The ADC resolution is a user programmable mode that can be changed through the serial interface.

The ADT7311 is guaranteed to operate over supply voltages from 2.7 V to 5.5 V. Operating at 3.3 V, the average supply current is typically 210 μA . The ADT7311 has a shutdown mode that powers down the device and offers a shutdown current of typically 2 μA . The ADT7311 is rated for operation over the -40°C to $+150^{\circ}\text{C}$ temperature range.

The CT pin is an open-drain output that becomes active when the temperature exceeds a programmable critical temperature limit. The default critical temperature limit is 147 $^{\circ}\text{C}$. The INT pin is also an open-drain output that becomes active when the temperature exceeds a programmable limit. The INT and CT pins can operate in either comparator or interrupt mode.

PRODUCT HIGHLIGHTS

1. Ease of use, no calibration or correction required by the user.
2. Low power consumption.
3. Excellent long-term stability and reliability.
4. Packaged in an 8-lead SOIC, RoHS-compliant package.

FUNCTIONAL BLOCK DIAGRAM

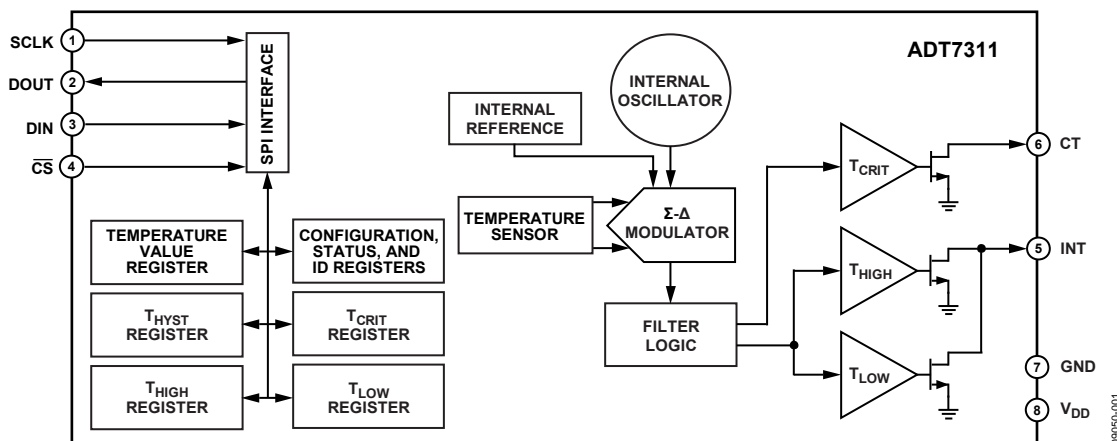

Figure 1.

Rev. 0

Information furnished by Analog Devices is believed to be accurate and reliable. However, no responsibility is assumed by Analog Devices for its use, nor for any infringements of patents or other rights of third parties that may result from its use. Specifications subject to change without notice. No license is granted by implication or otherwise under any patent or patent rights of Analog Devices. Trademarks and registered trademarks are the property of their respective owners.

One Technology Way, P.O. Box 9106, Norwood, MA 02062-9106, U.S.A.

Tel: 781.329.4700

Fax: 781.461.3113

www.analog.com

©2011 Analog Devices, Inc. All rights reserved.

TABLE OF CONTENTS

Features	1	Configuration Register	14
Applications.....	1	Temperature Value Register.....	15
General Description.....	1	ID Register.....	15
Product Highlights	1	T _{CRIT} Setpoint Register	15
Functional Block Diagram	1	T _{HYST} Setpoint Register.....	16
Revision History	2	T _{HIGH} Setpoint Register	16
Specifications.....	3	T _{LOW} Setpoint Register	16
SPI Timing Specifications	4	Serial Peripheral Interface	17
Absolute Maximum Ratings.....	5	SPI Command Byte.....	17
ESD Caution.....	5	Writing Data	18
Pin Configuration and Function Descriptions.....	6	Reading Data.....	19
Typical Performance Characteristics	7	Interfacing to DSPs or Microcontrollers	19
Theory of Operation	9	Serial Interface Reset.....	19
Circuit Information.....	9	INT and CT Outputs.....	20
Converter Details.....	9	Undertemperature and Overtemperature Detection	20
Temperature Measurement	9	Applications Information	22
One-Shot Mode	10	Thermal Response Time	22
1 SPS Mode.....	10	Supply Decoupling	22
Shutdown.....	11	Powering from a Switching Regulator.....	22
Fault Queue	11	Temperature Monitoring.....	22
Temperature Data Format	12	Quick Guide to Measuring Temperature	22
Temperature Conversion Formulas	12	Outline Dimensions	23
Registers.....	13	Ordering Guide	23
Status Register	13	Automotive Products.....	23

REVISION HISTORY

9/11—Revision 0: Initial Version

SPECIFICATIONS

$T_A = -40^{\circ}\text{C}$ to $+150^{\circ}\text{C}$; $V_{DD} = 2.7\text{ V}$ to 5.5 V ; unless otherwise noted.

Table 1.

Parameter	Min	Typ	Max	Unit	Test Conditions/Comments
TEMPERATURE SENSOR AND ADC					
Accuracy ¹		-0.05	± 0.4 ± 0.44 ± 0.5 ± 0.5 ± 0.7 ± 0.8 ± 1.0	$^{\circ}\text{C}$ $^{\circ}\text{C}$ $^{\circ}\text{C}$ $^{\circ}\text{C}$ $^{\circ}\text{C}$ $^{\circ}\text{C}$ $^{\circ}\text{C}$	$T_A = -40^{\circ}\text{C}$ to $+105^{\circ}\text{C}$, $V_{DD} = 3.0\text{ V}$ $T_A = -40^{\circ}\text{C}$ to $+105^{\circ}\text{C}$, $V_{DD} = 2.7\text{ V}$ to 3.3 V $T_A = -40^{\circ}\text{C}$ to $+125^{\circ}\text{C}$, $V_{DD} = 3.0\text{ V}$ $T_A = -40^{\circ}\text{C}$ to $+105^{\circ}\text{C}$, $V_{DD} = 2.7\text{ V}$ to 3.6 V $T_A = -40^{\circ}\text{C}$ to $+150^{\circ}\text{C}$, $V_{DD} = 2.7\text{ V}$ to 3.6 V $T_A = -40^{\circ}\text{C}$ to $+105^{\circ}\text{C}$, $V_{DD} = 4.5\text{ V}$ to 5.5 V $T_A = -40^{\circ}\text{C}$ to $+150^{\circ}\text{C}$, $V_{DD} = 2.7\text{ V}$ to 5.5 V
ADC Resolution		13		Bits	Twos complement temperature value of sign bit plus 12 ADC bits (power-up default resolution)
		16		Bits	Twos complement temperature value of sign bit plus 15 ADC bits (Bit 7 = 1 in the configuration register)
Temperature Resolution					
13-Bit		0.0625		$^{\circ}\text{C}$	13-bit resolution (sign + 12 bits)
16-Bit		0.0078		$^{\circ}\text{C}$	16-bit resolution (sign + 15 bits)
Temperature Conversion Time		240		ms	Continuous conversion and one-shot conversion mode
Fast Temperature Conversion Time		6		ms	First conversion on power-up only
1 SPS Conversion Time		60		ms	Conversion time for 1 SPS mode
Temperature Hysteresis		± 0.002		$^{\circ}\text{C}$	Temperature cycle = 25°C to 125°C and back to 25°C
Repeatability		± 0.015		$^{\circ}\text{C}$	$T_A = 25^{\circ}\text{C}$
DC PSRR		0.1		$^{\circ}\text{C}/\text{V}$	$T_A = 25^{\circ}\text{C}$
DIGITAL OUTPUTS (CT, INT), OPEN DRAIN					
High Output Leakage Current, I_{OH}		0.1	5	μA	CT and INT pins pulled up to 5.5 V
Output Low Voltage, V_{OL}			0.4	V	$I_{OL} = 2\text{ mA}$ at 5.5 V, $I_{OL} = 1\text{ mA}$ at 3.3 V
Output High Voltage, V_{OH}	$0.7 \times V_{DD}$			V	
Output Capacitance, C_{OUT}		2		pF	
DIGITAL INPUTS (DIN, SCLK, CS)					
Input Current			± 1	μA	$V_{IN} = 0\text{ V}$ to V_{DD}
Input Low Voltage, V_{IL}			0.4	V	
Input High Voltage, V_{IH}	$0.7 \times V_{DD}$			V	
Pin Capacitance		5	10	pF	
DIGITAL OUTPUT (DOUT)					
Output High Voltage, V_{OH}	$V_{OH} - 0.3$			V	$I_{SOURCE} = I_{SINK} = 200\ \mu\text{A}$
Output Low Voltage, V_{OL}			0.4	V	$I_{OL} = 200\ \mu\text{A}$
Output Capacitance, C_{OUT}			50	pF	
POWER REQUIREMENTS					
Supply Voltage	2.7		5.5	V	
Supply Current					
At 3.3 V		210	265	μA	Peak current while converting, SPI interface inactive
At 5.5 V		250	300	μA	Peak current while converting, SPI interface inactive
1 SPS Current					
At 3.3 V		46		μA	$V_{DD} = 3.3\text{ V}$, 1 SPS mode, $T_A = 25^{\circ}\text{C}$
At 5.5 V		65		μA	$V_{DD} = 5.5\text{ V}$, 1 SPS mode, $T_A = 25^{\circ}\text{C}$

Parameter	Min	Typ	Max	Unit	Test Conditions/Comments
Shutdown Current					
At 3.3 V		2.0	15	μA	Supply current in shutdown mode
At 5.5 V		5.2	25	μA	Supply current in shutdown mode
Power Dissipation Normal Mode		700		μW	V _{DD} = 3.3 V, normal mode at 25°C
Power Dissipation 1 SPS		150		μW	Power dissipated for V _{DD} = 3.3 V, T _A = 25°C

¹ Accuracy includes lifetime drift.

SPI TIMING SPECIFICATIONS

T_A = -40°C to +150°C, V_{DD} = 2.7 V to 5.5 V, unless otherwise noted. All input signals are specified with rise time (t_R) = fall time (t_F) = 5 ns (10% to 90% of V_{DD}) and timed from a voltage level of 1.6 V.

Table 2.

Parameter ^{1,2}	Limit at T _{MIN} , T _{MAX}	Unit	Conditions/Comments
t ₁	0	ns min	\overline{CS} falling edge to SCLK active edge setup time
t ₂	100	ns min	SCLK high pulse width
t ₃	100	ns min	SCLK low pulse width
t ₄	30	ns min	Data setup time prior to SCLK rising edge
t ₅	25	ns min	Data hold time after SCLK rising edge
t ₆	5	ns min	Data access time after SCLK falling edge
	60	ns max	V _{DD} = 4.5 V to 5.5 V
	80	ns max	V _{DD} = 2.7 V to 3.6 V
t ₇ ³	10	ns min	Bus relinquish time after \overline{CS} inactive edge
	80	ns max	
t ₈	0	ns min	SCLK inactive edge to \overline{CS} rising edge hold time
t ₉	0	ns min	\overline{CS} falling edge to DOUT active time
	60	ns max	V _{DD} = 4.5 V to 5.5 V
	80	ns max	V _{DD} = 2.7 V to 3.6 V
t ₁₀	10	ns min	SCLK inactive edge to DOUT low

¹ Sample tested during initial release to ensure compliance. All input signals are specified with t_R = t_F = 5 ns (10% to 90% of V_{DD}) and timed from a voltage level of 1.6 V.

² See Figure 2.

³ This means that the times quoted in the timing characteristics in Table 2 are the true bus relinquish times of the part and, as such, are independent of external bus loading capacitances.

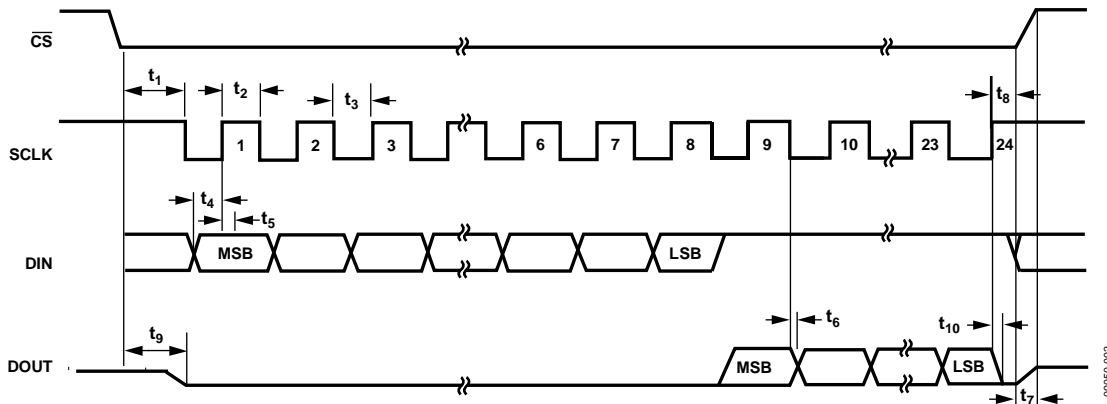

Figure 2. Detailed SPI Timing Diagram

ABSOLUTE MAXIMUM RATINGS

Table 3.

Parameter	Rating
V _{DD} to GND	−0.3 V to +7 V
DIN Input Voltage to GND	−0.3 V to V _{DD} + 0.3 V
DOOUT Voltage to GND	−0.3 V to V _{DD} + 0.3 V
SCLK Input Voltage to GND	−0.3 V to V _{DD} + 0.3 V
CS Input Voltage to GND	−0.3 V to V _{DD} + 0.3 V
CT and INT Output Voltage to GND	−0.3 V to V _{DD} + 0.3 V
ESD Rating (Human Body Model)	2.0 kV
Operating Temperature Range ¹	−40°C to +150°C
Storage Temperature Range	−65°C to +160°C
Maximum Junction Temperature, T _{JMAX}	150°C
8-Lead SOIC_N (R-8)	
Power Dissipation ²	$W_{MAX} = (T_{JMAX} - T_A^3)/\theta_{JA}$
Thermal Impedance ⁴	
θ _{JA} , Junction-to-Ambient (Still Air)	121°C/W
θ _{JC} , Junction-to-Case	56°C/W
IR Reflow Soldering	220°C
Peak Temperature (RoHS-Compliant Package)	260°C (0°C)
Time at Peak Temperature	20 sec to 40 sec
Ramp-Up Rate	3°C/sec maximum
Ramp-Down Rate	−6°C/sec maximum
Time from 25°C to Peak Temperature	8 minutes maximum

¹ Operating at extended temperatures over prolonged periods depends on the lifetime performance of the part. Consult your local Analog Devices, Inc., account representative for more details.

² Value relates to package being used on a standard 2-layer PCB. This gives a worst-case θ_{JA} and θ_{JC}.

³ T_A = ambient temperature.

⁴ Junction-to-case resistance is applicable to components featuring a preferential flow direction, for example, components mounted on a heat sink. Junction-to-ambient is more useful for air-cooled, PCB-mounted components.

Stresses above those listed under Absolute Maximum Ratings may cause permanent damage to the device. This is a stress rating only; functional operation of the device at these or any other conditions above those indicated in the operational section of this specification is not implied. Exposure to absolute maximum rating conditions for extended periods may affect device reliability.

ESD CAUTION



ESD (electrostatic discharge) sensitive device.

Charged devices and circuit boards can discharge without detection. Although this product features patented or proprietary protection circuitry, damage may occur on devices subjected to high energy ESD. Therefore, proper ESD precautions should be taken to avoid performance degradation or loss of functionality.

PIN CONFIGURATION AND FUNCTION DESCRIPTIONS



Figure 3. Pin Configuration

Table 4. Pin Function Descriptions

Pin No.	Mnemonic	Description
1	SCLK	Serial Clock Input. The serial clock is used to clock in and clock out data to and from any register of the ADT7311 .
2	DOUT	Serial Data Output. Data is clocked out on the SCLK falling edge and is valid on the SCLK rising edge.
3	DIN	Serial Data Input. Serial data to be loaded to the part's control registers is provided on this input. Data is clocked into the registers on the rising edge of SCLK.
4	$\overline{\text{CS}}$	Chip Select Input. The device is selected when this input is low. The device is disabled when this pin is high.
5	INT	Overtemperature and Undertemperature Indicator. Logic output. The power-up default setting is as an active low comparator interrupt. Open-drain configuration. A pull-up resistor is required, typically 10 k Ω .
6	CT	Critical Overtemperature Indicator. Logic output. Power-up default polarity is active low. Open-drain configuration. A pull-up resistor is required, typically 10 k Ω .
7	GND	Analog and Digital Ground.
8	V _{DD}	Positive Supply Voltage (2.7 V to 5.5 V). The supply should be decoupled with a 0.1 μF ceramic capacitor to GND.

TYPICAL PERFORMANCE CHARACTERISTICS

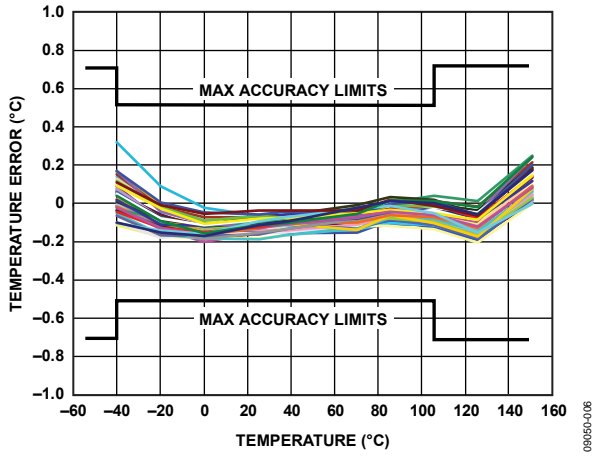

Figure 4. Temperature Accuracy at 3 V

09050-006

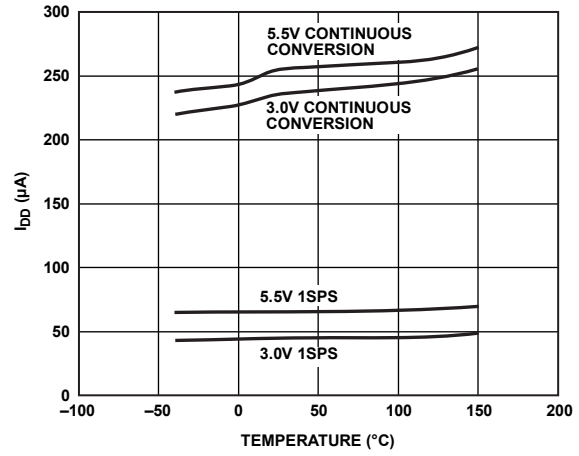

Figure 6. Operating Supply Current vs. Temperature

09050-007

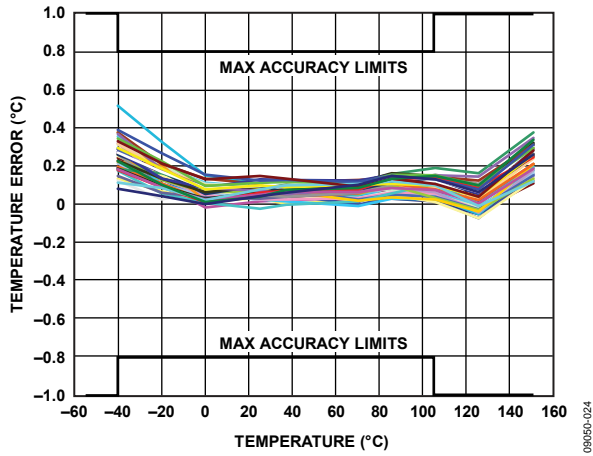

Figure 5. Temperature Accuracy at 5 V

09050-024

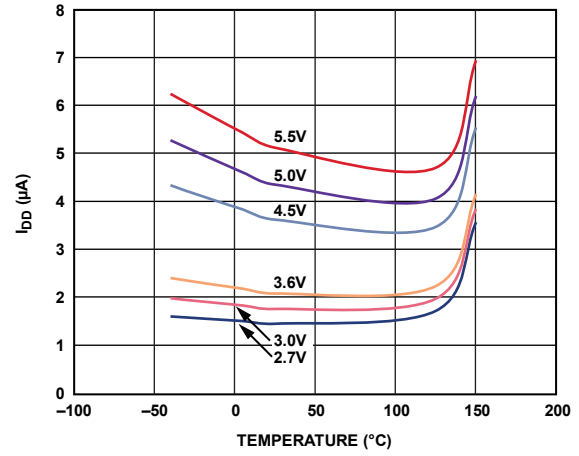

Figure 7. Shutdown Current vs. Temperature

09050-025

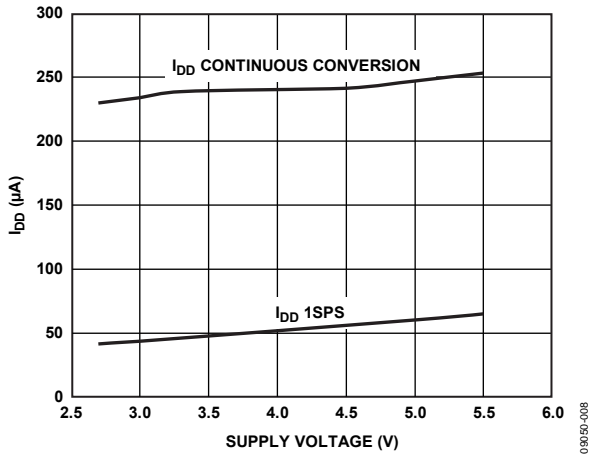

Figure 8. Average Operating Supply Current vs. Supply Voltage at 25°C

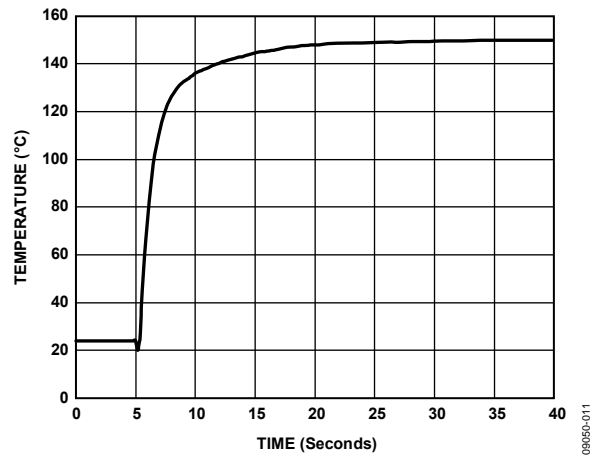

Figure 10. Response to Thermal Shock

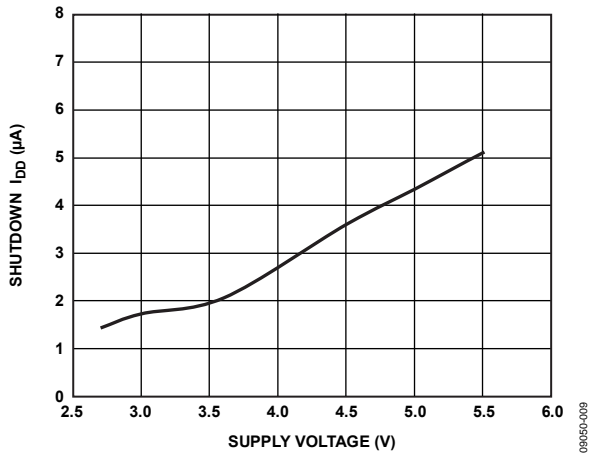

Figure 9. Shutdown Current vs. Supply Voltage at 25°C

THEORY OF OPERATION

CIRCUIT INFORMATION

The ADT7311 is a high accuracy digital temperature sensor that uses a 16-bit ADC to monitor and digitize the temperature to 0.0078°C of resolution. The ADC resolution, by default, is set to 13 bits (0.0625°C). An internal temperature sensor generates a voltage proportional to absolute temperature, which is compared to an internal voltage reference and input into a precision digital modulator.

The internal temperature sensor has high accuracy and linearity over the entire rated temperature range without needing correction or calibration by the user.

The sensor output is digitized by a sigma-delta (Σ - Δ) modulator, also known as the charge balance type analog-to-digital converter. This type of converter utilizes time-domain oversampling and a high accuracy comparator to deliver 16 bits of resolution in an extremely compact circuit.

CONVERTER DETAILS

The Σ - Δ modulator consists of an input sampler, a summing network, an integrator, a comparator, and a 1-bit DAC. This architecture creates a negative feedback loop and minimizes the integrator output by changing the duty cycle of the comparator output in response to input voltage changes. The comparator samples the output of the integrator at a much higher rate than the input sampling frequency. This oversampling spreads the quantization noise over a much wider band than that of the input signal, improving overall noise performance and increasing accuracy.

The modulated output of the comparator is encoded using a circuit technique that results in SPI temperature data.

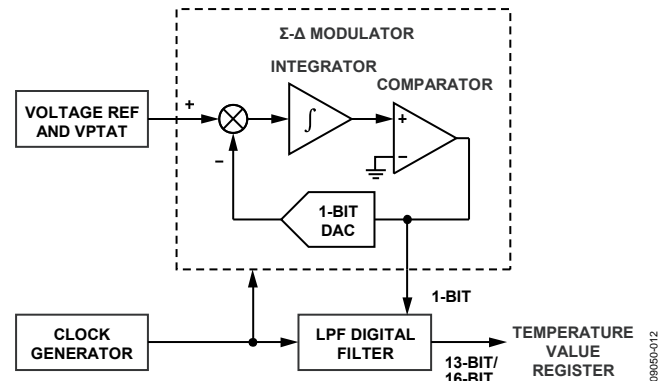

Figure 11. Σ - Δ Modulator

TEMPERATURE MEASUREMENT

In normal mode (default power-up mode), the ADT7311 runs an automatic conversion sequence. During this automatic conversion sequence, a conversion typically takes 240 ms to complete and the ADT7311 is continuously converting. This means that as soon as one temperature conversion is completed, another temperature conversion begins. Each temperature conversion result is stored in the temperature value register and is available through the SPI interface. In continuous conversion mode, the read operation provides the most recent converted result.

On power-up, the first conversion is a fast conversion, taking typically 6 ms. If the temperature exceeds 147°C, the CT pin asserts low. If the temperature exceeds 64°C, the INT pin asserts low. Fast conversion temperature accuracy is typically within $\pm 5^\circ\text{C}$.

The conversion clock for the part is generated internally. No external clock is required except when reading from and writing to the serial port.

The measured temperature value is compared with a critical temperature limit (stored in the 16-bit T_{CRIT} setpoint read/write register), a high temperature limit (stored in the 16-bit T_{HIGH} setpoint read/write register), and a low temperature limit (stored in the 16-bit T_{LOW} setpoint read/write register). If the measured value exceeds these limits, the INT pin is activated; and if it exceeds the T_{CRIT} limit, the CT pin is activated. The INT and CT pins are programmable for polarity via the configuration register, and the INT and CT pins are also programmable for interrupt mode via the configuration register.

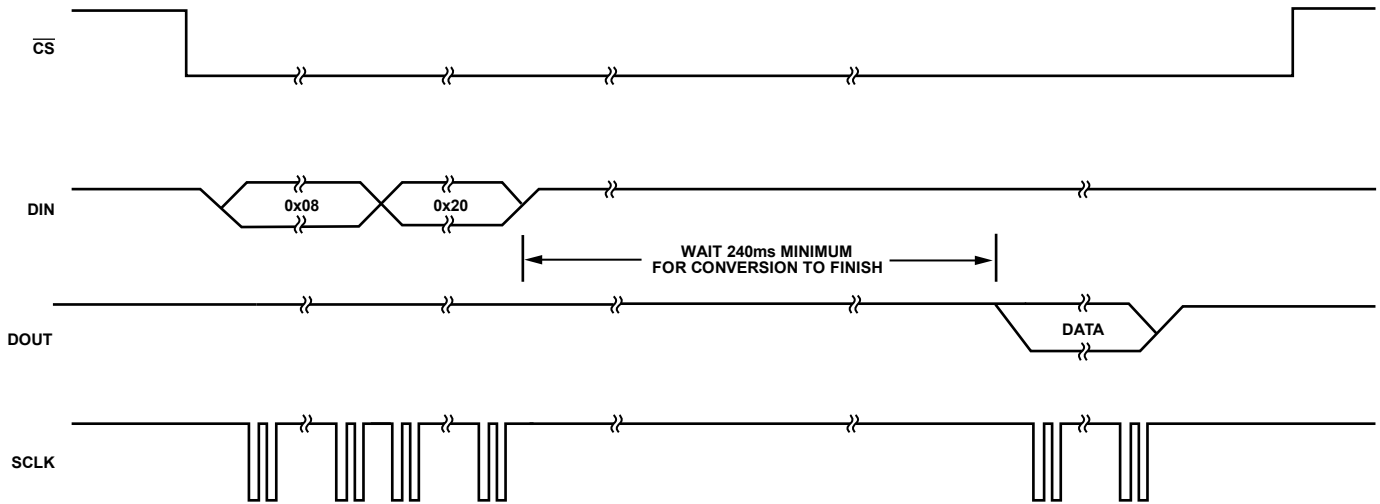

Figure 12. Typical SPI One-Shot Write to Configuration Register Followed by a Read from the Temperature Value Register

09050-1026

ONE-SHOT MODE

Setting Bit 6 to 0 and Bit 5 to 1 of the configuration register (Register Address 0x01) enables the one-shot mode. When this mode is enabled, the ADT7311 immediately completes a conversion and then goes into shutdown mode.

Wait for a minimum of 240 ms after writing to the operation mode bits before reading back the temperature from the temperature value register. This time ensures that the ADT7311 has time to power up and complete a conversion.

To obtain an updated temperature conversion, reset the Bit 6 to 0 and Bit 5 to 1 in the configuration register (0x01).

The one-shot mode is useful when one of the circuit design priorities is to reduce power consumption.

1 SPS MODE

In this mode, the part performs one measurement per second. A conversion takes only 60 ms, and it remains in the idle state for the remaining 940 ms period. This mode is enabled by writing 1 to Bit 6 and 0 to Bit 5 of the configuration register (Register Address 0x01).

CT and INT Operation in One-Shot Mode

See Figure 13 for more information on one-shot CT pin operation for T_{CRIT} overtemperature events when one of the limits is exceeded. Note that, in interrupt mode, a read from any register resets the INT and CT pins.

For the INT pin in comparator mode, if the temperature drops below the $T_{HIGH} - T_{HYST}$ value or goes above the $T_{LOW} + T_{HYST}$ value, a write to the operation mode bits (Bit 5 and Bit 6 of the configuration register, Register Address 0x01) resets the INT pin.

For the CT pin in comparator mode, if the temperature drops below the $T_{CRIT} - T_{HYST}$ value, a write to the operation mode bits (Bit 5 and Bit 6 of the configuration register, Register Address 0x01) resets the CT pin (see Figure 13).

When using one-shot mode, ensure that the refresh rate is appropriate to the application being used.

SHUTDOWN

The ADT7311 can be placed in shutdown mode by writing 1 to Bit 6 and 1 to Bit 5 of the configuration register (Register Address 0x01). The ADT7311 can be taken out of shutdown

mode by writing 0 to Bit 6 and 0 to Bit 5 of the configuration register (Register Address 0x01). The ADT7311 typically takes 1 ms (with a 0.1 μ F decoupling capacitor) to come out of shutdown mode. The conversion result from the last conversion prior to shutdown can still be read from the ADT7311 even when it is in shutdown mode. When the part is taken out of shutdown mode, the internal clock is started and a conversion is initiated.

FAULT QUEUE

Bit 0 and Bit 1 of the configuration register (Register Address 0x01) are used to set up a fault queue. Up to four faults are provided to prevent false tripping of the INT and CT pins when the ADT7311 is used in a noisy temperature environment. The number of faults set in the queue must occur consecutively to set the INT and CT outputs. For example, if the number of faults set in the queue is four, then four consecutive temperature conversions must occur, with each result exceeding a temperature limit in any of the limit registers, before the INT and CT pins are activated. If two consecutive temperature conversions exceed a temperature limit and the third conversion does not, the fault count is reset to 0.

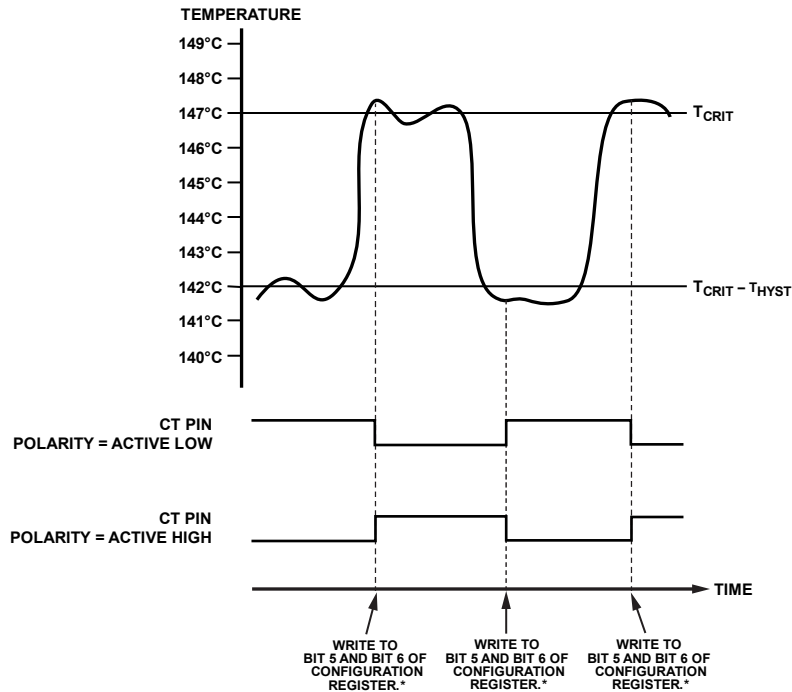

*THERE IS A 240ms DELAY BETWEEN WRITING TO THE CONFIGURATION REGISTER TO START A STANDARD ONE-SHOT CONVERSION AND THE CT PIN GOING ACTIVE. THIS IS DUE TO THE CONVERSION TIME. THE DELAY IS 60ms IN THE CASE OF A ONE-SHOT CONVERSION.

Figure 13. One-Shot CT Pin

0906-013

TEMPERATURE DATA FORMAT

One LSB of the ADC corresponds to 0.0625°C in 13-bit mode. The ADC can theoretically measure a temperature range of 255°C, but the ADT7311 is guaranteed to measure a low value temperature limit of –40°C to a high value temperature limit of +150°C. The temperature measurement result is stored in the 16-bit temperature value register and is compared with the high temperature limits stored in the T_{CRIT} setpoint register and the T_{HIGH} setpoint register. It is also compared with the low temperature limit stored in the T_{LOW} setpoint register.

Temperature data in the temperature value register, the T_{CRIT} setpoint register, the T_{HIGH} setpoint register, and the T_{LOW} setpoint register is represented by a 13-bit twos complement word. The MSB is the temperature sign bit. The three LSBs, Bit 0 to Bit 2, on power-up, are not part of the temperature conversion result and are flag bits for T_{CRIT}, T_{HIGH}, and T_{LOW}. Table 5 shows the 13-bit temperature data format without Bit 0 to Bit 2.

The number of bits in the temperature data-word can be extended to 16 bits, twos complement, by setting Bit 7 to 1 in the configuration register (Register Address 0x01). When using a 16-bit temperature data value, Bit 0 to Bit 2 are not used as flag bits and are instead the LSB bits of the temperature value. The power-on default setting has a 13-bit temperature data value.

Reading back the temperature from the temperature value register requires a 2-byte read. Designers that use a 9-bit temperature data format can still use the ADT7311 by ignoring the last four LSBs of the 13-bit temperature value. These four LSBs are Bit 3 to Bit 6 in Table 5.

Table 5. 13-Bit Temperature Data Format

Temperature	Digital Output (Binary) Bits[15:3]	Digital Output (Hex)
–40°C	1 1100 1110 0000	0x1CE0
–25°C	1 1110 0111 0000	0x1E70
–0.0625°C	1 1111 1111 1111	0x1FFF
0°C	0 0000 0000 0000	0x000
+0.0625°C	0 0000 0000 0001	0x001
+25°C	0 0001 1001 0000	0x190
+50°C	0 0011 0010 0000	0x320
+125°C	0 0111 1101 0000	0x7D0
+150°C	0 1001 0110 0000	0x960

TEMPERATURE CONVERSION FORMULAS

16-Bit Temperature Data Format

$$\text{Positive Temperature} = \text{ADC Code}(\text{dec})/128$$

$$\text{Negative Temperature} = (\text{ADC Code}(\text{dec}) - 65,536)/128$$

where ADC Code uses all 16 bits of the data byte, including the sign bit.

$$\text{Negative Temperature} = (\text{ADC Code}(\text{dec}) - 32,768)/128$$

where the MSB is removed from the ADC code.

13-Bit Temperature Data Format

$$\text{Positive Temperature} = \text{ADC Code}(\text{dec})/16$$

$$\text{Negative Temperature} = (\text{ADC Code}(\text{dec}) - 8192)/16$$

where ADC Code uses all 13 bits of the data byte, including the sign bit.

$$\text{Negative Temperature} = (\text{ADC Code}(\text{dec}) - 4096)/16$$

where the MSB is removed from the ADC code.

10-Bit Temperature Data Format

$$\text{Positive Temperature} = \text{ADC Code}(\text{dec})/2$$

$$\text{Negative Temperature} = (\text{ADC Code}(\text{dec}) - 1024)/2$$

where ADC Code uses all 10 bits of the data byte, including the sign bit.

$$\text{Negative Temperature} = (\text{ADC Code}(\text{dec}) - 512)/2$$

where the MSB is removed from the ADC code.

9-Bit Temperature Data Format

$$\text{Positive Temperature} = \text{ADC Code}(\text{dec})$$

$$\text{Negative Temperature} = \text{ADC Code}(\text{dec}) - 512$$

where ADC Code uses all nine bits of the data byte, including the sign bit.

$$\text{Negative Temperature} = \text{ADC Code}(\text{dec}) - 256$$

where the MSB is removed from the ADC code.

REGISTERS

The ADT7311 contains eight registers:

- A status register
- A configuration register
- Five temperature registers
- An ID register

The status register, temperature value register, and the ID register are read-only.

Table 6. ADT7311 Registers

Register Address	Description	Power-On Default
0x00	Status	0x80
0x01	Configuration	0x00
0x02	Temperature value	0x0000
0x03	ID	0xC3
0x04	T _{CRIT} setpoint	0x4980 (147°C)
0x05	T _{HYST} setpoint	0x05 (5°C)
0x06	T _{HIGH} setpoint	0x2000 (64°C)
0x07	T _{LOW} setpoint	0x0500 (10°C)

STATUS REGISTER

This 8-bit read-only register (Register Address 0x00) reflects the status of the overtemperature and undertemperature interrupts that can cause the CT and INT pins to go active. It also reflects the status of a temperature conversion operation. The interrupt flags in this register are reset by a read operation to the status register and/or when the temperature value returns within the temperature limits including hysteresis. The RDY bit is reset after a read from the temperature value register. In one-shot and 1 SPS modes, the RDY bit is reset after a write to the operation mode bits.

Table 7. Status Register (Register Address 0x00)

Bit	Default Value	Type	Name	Description
[3:0]	0000	R	Unused	Reads back 0.
4	0	R	T _{LOW}	This bit is set to 1 when the temperature goes below the T _{LOW} temperature limit. The bit clears to 0 when the status register is read and/or when the temperature measured goes back above the limit set in the T _{LOW} + T _{HYST} setpoint registers.
5	0	R	T _{HIGH}	This bit is set to 1 when the temperature rises above the T _{HIGH} temperature limit. The bit clears to 0 when the status register is read and/or when the temperature measured drops below the limit set in the T _{HIGH} – T _{HYST} setpoint registers.
6	0	R	T _{CRIT}	This bit is set to 1 when the temperature rises above the T _{CRIT} temperature limit. This bit clears to 0 when the status register is read and/or when the temperature measured drops below the limit set in the T _{CRIT} – T _{HYST} setpoint registers.
7	1	R	RDY	This bit goes low when the temperature conversion result is written into the temperature value register. It is reset to 1 when the temperature value register is read. In one-shot and 1 SPS modes, this bit is reset after a write to the operation mode bits.

CONFIGURATION REGISTER

This 8-bit read/write register (Register Address 0x01) stores various configuration modes for the [ADT7311](#), including shutdown, overtemperature and undertemperature interrupts, one-shot,

continuous conversion, interrupt pins polarity, and overtemperature fault queues.

Table 8. Configuration Register (Register Address 0x01)

Bit	Default Value	Type	Name	Description
[1:0]	00	R/W	Fault queue	These two bits set the number of undertemperature/overtemperature faults that can occur before setting the INT and CT pins. This helps to avoid false triggering due to temperature noise. 00 = 1 fault (default). 01 = 2 faults. 10 = 3 faults. 11 = 4 faults.
2	0	R/W	CT pin polarity	This bit selects the output polarity of the CT pin. 0 = active low. 1 = active high.
3	0	R/W	INT pin polarity	This bit selects the output polarity of the INT pin. 0 = active low. 1 = active high.
4	0	R/W	INT/CT mode	This bit selects between comparator mode and interrupt mode. 0 = interrupt mode. 1 = comparator mode.
[6:5]	00	R/W	Operation mode	These two bits set the operational mode for the ADT7311 . 00 = continuous conversion (default). When one conversion is finished, the ADT7311 starts another. 01 = one shot. Conversion time is typically 240 ms. 10 = 1 SPS mode. Conversion time is typically 60 ms. This operational mode reduces the average current consumption. 11 = shutdown. All circuitry except interface circuitry is powered down.
7	0	R/W	Resolution	This bit sets up the resolution of the ADC when converting. 0 = 13-bit resolution. Sign bit + 12 bits gives a temperature resolution of 0.0625°C. 1 = 16-bit resolution. Sign bit + 15 bits gives a temperature resolution of 0.0078°C.

TEMPERATURE VALUE REGISTER

The temperature value register stores the temperature measured by the internal temperature sensor. The temperature is stored as a 16-bit twos complement format. The temperature is read back from the temperature value register (Register Address 0x02) as a 16-bit value.

Bit 2, Bit 1, and Bit 0 are event alarm flags for T_{CRIT} , T_{HIGH} , and T_{LOW} . When the ADC is configured to convert the temperature to a 16-bit digital value, Bit 2, Bit 1, and Bit 0 are no longer used as flag bits and are, instead, used as the LSB bits for the extended digital value.

ID REGISTER

This 8-bit read-only register (Register Address 0x03) stores the manufacturer ID in Bit 7 to Bit 3 and the silicon revision in Bit 2 to Bit 0.

T_{CRIT} SETPOINT REGISTER

The 16-bit T_{CRIT} setpoint register (Register Address 0x04) stores the critical overtemperature limit value. A critical overtemperature event occurs when the temperature value stored in the temperature value register exceeds the value stored in this register. The CT pin is activated if a critical overtemperature event occurs. The temperature is stored in twos complement format with the MSB being the temperature sign bit.

The default setting for the T_{CRIT} setpoint is 147°C.

Table 9. Temperature Value Register (Register Address 0x02)

Bit	Default Value	Type	Name	Description
0	0	R	T_{LOW} flag/LSB0	Flags a T_{LOW} event if the configuration register, Register Address 0x01[7] = 0 (13-bit resolution). When the temperature value is below T_{LOW} , this bit is set to 1. Contains the Least Significant Bit 0 of the 15-bit temperature value if the configuration register, Register Address 0x01[7] = 1 (16-bit resolution).
1	0	R	T_{HIGH} flag/LSB1	Flags a T_{HIGH} event if the configuration register, Register Address 0x01[7] = 0 (13-bit resolution). When the temperature value is above T_{HIGH} , this bit is set to 1. Contains the Least Significant Bit 1 of the 15-bit temperature value if the configuration register, Register Address 0x01[7] = 1 (16-bit resolution).
2	0	R	T_{CRIT} flag/LSB2	Flags a T_{CRIT} event if the configuration register, Register Address 0x01[7] = 0 (13-bit resolution). When the temperature value exceeds T_{CRIT} , this bit is set to 1. Contains the Least Significant Bit 2 of the 15-bit temperature value if the configuration register, Register Address 0x01[7] = 1 (16-bit resolution).
[7:3]	00000	R	Temp	Temperature value in twos complement format.
[14:8]	0000000	R	Temp	Temperature value in twos complement format.
15	0	R	Sign	Sign bit, indicates if the temperature value is negative or positive.

Table 10. ID Register (Register Address 0x03)

Bit	Default Value	Type	Name	Description
[2:0]	011	R	Revision ID	Contains the silicon revision identification number.
[7:3]	11000	R	Manufacturer ID	Contains the manufacturer identification number.

Table 11. T_{CRIT} Setpoint Register (Register Address 0x04)

Bit	Default Value	Type	Name	Description
[15:0]	0x4980	R/W	T_{CRIT}	16-bit critical overtemperature limit, stored in twos complement format.

T_{HYST} SETPOINT REGISTER

The T_{HYST} setpoint 8-bit register (Register Address 0x05) stores the temperature hysteresis value for the T_{HIGH}, T_{LOW}, and T_{CRIT} temperature limits. The temperature hysteresis value is stored in straight binary format using four LSBs. Increments are possible in steps of 1°C from 0°C to 15°C. The value in this register is subtracted from the T_{HIGH} and T_{CRIT} values and added to the T_{LOW} value to implement hysteresis.

The default setting for the T_{HYST} setpoint is 5°C.

T_{HIGH} SETPOINT REGISTER

The 16-bit T_{HIGH} setpoint register (Register Address 0x06) stores the overtemperature limit value. An overtemperature event occurs when the temperature value stored in the temperature value register exceeds the value stored in this register. The INT pin

is activated if an overtemperature event occurs. The temperature is stored in twos complement format with the most significant bit being the temperature sign bit.

The default setting for the T_{HIGH} setpoint is 64°C.

T_{LOW} SETPOINT REGISTER

The 16-bit T_{LOW} setpoint register (Register Address 0x07) stores the undertemperature limit value. An undertemperature event occurs when the temperature value stored in the temperature value register is less than the value stored in this register. The INT pin is activated if an undertemperature event occurs. The temperature is stored in twos complement format with the MSB being the temperature sign bit.

The default setting for the T_{LOW} setpoint is 10°C.

Table 12. T_{HYST} Setpoint Register (Register Address 0x05)

Bit	Default Value	Type	Name	Description
[3:0]	0101	R/ \overline{W}	T _{HYST}	Hysteresis value, from 0°C to 15°C. Stored in straight binary format. The default setting is 5°C.
[7:4]	0000	R/ \overline{W}	N/A	Not used.

Table 13. T_{HIGH} Setpoint Register (Register Address 0x06)

Bit	Default Value	Type	Name	Description
[15:0]	0x2000	R/ \overline{W}	T _{HIGH}	16-bit overtemperature limit, stored in twos complement format.

Table 14. T_{LOW} Setpoint Register (Register Address 0x07)

Bit	Default Value	Type	Name	Description
[15:0]	0x0500	R/ \overline{W}	T _{LOW}	16-bit undertemperature limit, stored in twos complement format.

SERIAL PERIPHERAL INTERFACE

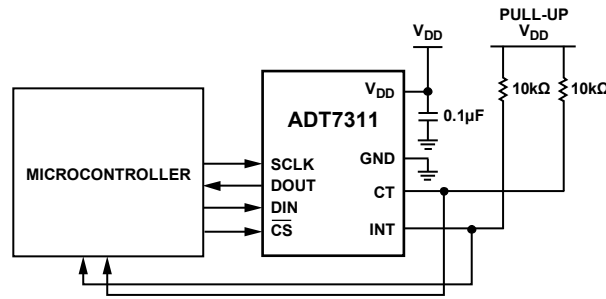

Figure 14. Typical SPI Interface Connection

The ADT7311 has a 4-wire serial peripheral interface (SPI). The interface has a data input pin (DIN) for inputting data to the device, a data output pin (DOUT) for reading data back from the device, and a data clock pin (SCLK) for clocking data into and out of the device. A chip select pin (\overline{CS}) enables or disables the serial interface. \overline{CS} is required for correct operation of the interface. Data is clocked out of the ADT7311 on the negative edge of SCLK, and data is clocked into the device on the positive edge of SCLK.

SPI COMMAND BYTE

All data transactions on the bus begin with the master taking \overline{CS} from high to low and sending out the command byte. This indicates to the ADT7311 whether the transaction is a read or a write and provides the address of the register for the data transfer. Table 15 shows the format of the command byte.

Table 15. Command Byte

C7	C6	C5	C4	C3	C2	C1	C0
0	R/W	Register address			0	0	0

Bit C7, Bit C2, Bit C1, and Bit C0 of the command byte must all be set to 0 to successfully begin a bus transaction. The SPI interface does not work correctly if a 1 is written into any of these bits.

Bit C6 is the read/write bit; 1 indicates a read, and 0 indicates a write.

Bits[C5:C3] contain the target register address. One register can be read from or written to per bus transaction.

WRITING DATA

Data is written to the ADT7311 in eight bits or 16 bits, depending on the addressed register. The first byte written to the device is the command byte, with the read/write bit set to 0. The master then supplies the 8-bit or 16-bit input data on the DIN line. The ADT7311 clocks the data into the register addressed in the command byte on the positive edge of SCLK. The master finishes the write by pulling CS high.

Figure 15 shows a write to an 8-bit register, and Figure 16 shows a write to a 16-bit register.

The master must begin a new write transaction on the bus for every register write. Only one register is written to per bus transaction.

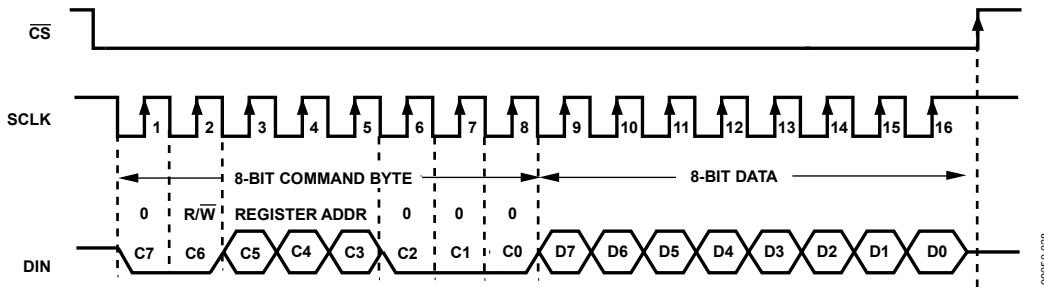

Figure 15. Writing to an 8-Bit Register

09650-028

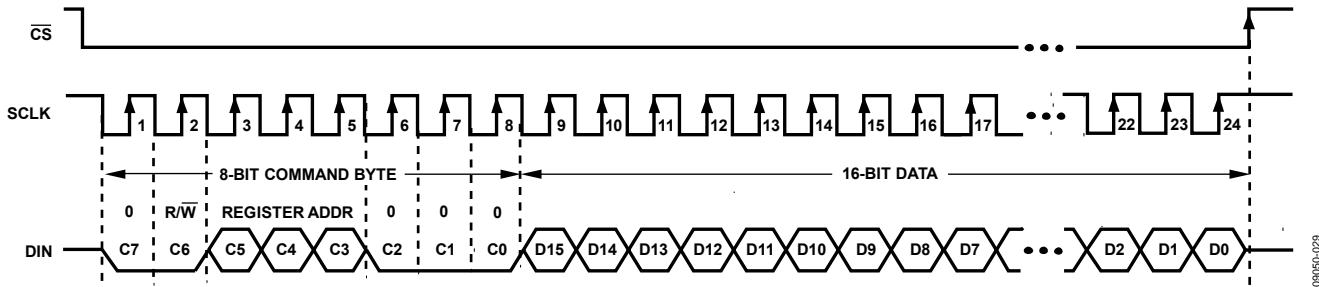

Figure 16. Writing to a 16-Bit Register

09650-029

READING DATA

A read transaction begins when the master writes the command byte to the ADT7311 with the read/write bit set to 1. The master then supplies eight or 16 clock pulses, depending on the addressed register, and the ADT7311 clocks out data from the addressed register on the DOUT line. Data is clocked out on the first falling edge of SCLK following the command byte.

The read transaction finishes when the master takes CS high.

INTERFACING TO DSPs OR MICROCONTROLLERS

The ADT7311 can be operated with CS used as a frame synchronization signal. This scheme is useful for DSP interfaces. In this case, the first bit (MSB) is effectively clocked out by CS because CS normally occurs after the falling edge of SCLK in DSPs. SCLK can continue to run between data transfers, provided that the timing specifications in Table 2 are obeyed.

CS can be tied to ground, and the serial interface can be operated in a 3-wire mode. DIN, DOUT, and SCLK are used to communicate with the ADT7311 in this mode.

For microcontroller interfaces, it is recommended that SCLK idle high between data transfers.

SERIAL INTERFACE RESET

The serial interface can be reset by writing a series of 1s on the DIN input. If a Logic 1 is written to the ADT7311 line for at least 32 serial clock cycles, the serial interface is reset. This ensures that the interface can be reset to a known state if the interface gets lost due to a software error or some glitch in the system. Reset returns the interface to the state in which it is expecting a write to the communications register. This operation resets the contents of all registers to their power-on values. Following a reset, the user should allow a period of 500 μs before addressing the serial interface.

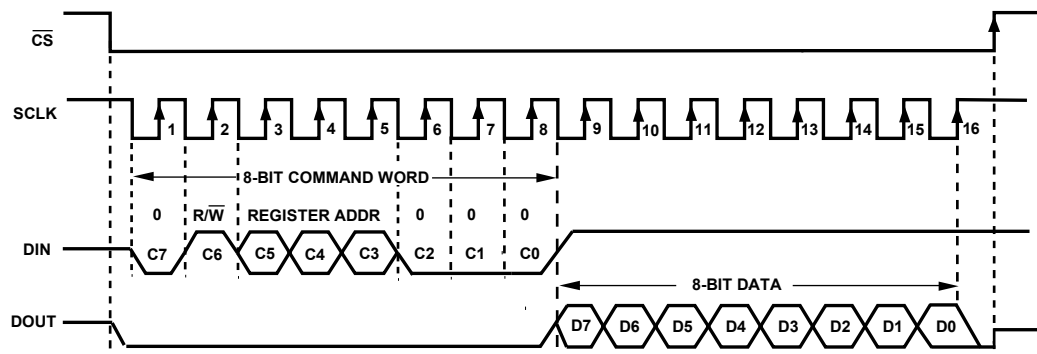

Figure 17. Reading from an 8-Bit Register

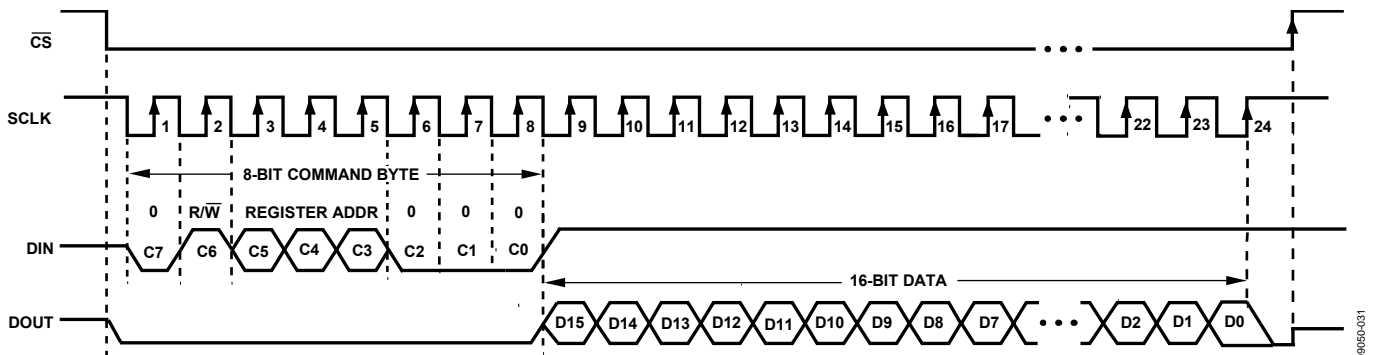

Figure 18. Reading from a 16-Bit Register

INT AND CT OUTPUTS

The INT and CT pins are open-drain outputs, and both pins require a 10 k Ω pull-up resistor to V_{DD}. The ADT7311 must be fully powered up to V_{DD} before reading INT and CT data.

UNDERTEMPERATURE AND OVERTEMPERATURE DETECTION

The INT and CT pins have two undertemperature/over-temperature modes: comparator mode and interrupt mode. The interrupt mode is the default power-up overtemperature mode. The INT output pin becomes active when the temperature is greater than the temperature stored in the T_{HIGH} setpoint register or less than the temperature stored in the T_{LOW} setpoint register. How this pin reacts after this event depends on the overtemperature mode selected.

Figure 19 illustrates the comparator and interrupt modes for events exceeding the T_{HIGH} limit with both pin polarity settings. Figure 20 illustrates the comparator and interrupt modes for events exceeding the T_{LOW} limit with both pin polarity settings.

Comparator Mode

In comparator mode, the INT pin returns to its inactive status when the temperature drops below the T_{HIGH} - T_{HYST} limit or rises above the T_{LOW} + T_{HYST} limit.

Putting the ADT7311 into shutdown mode does not reset the INT state in comparator mode.

Interrupt Mode

In interrupt mode, the INT pin goes inactive when any ADT7311 register is read. When the INT pin is reset, it goes active again only when the temperature is greater than the temperature stored in the T_{HIGH} setpoint register or less than the temperature stored in the T_{LOW} setpoint register.

Placing the ADT7311 into shutdown mode resets the INT pin in the interrupt mode.

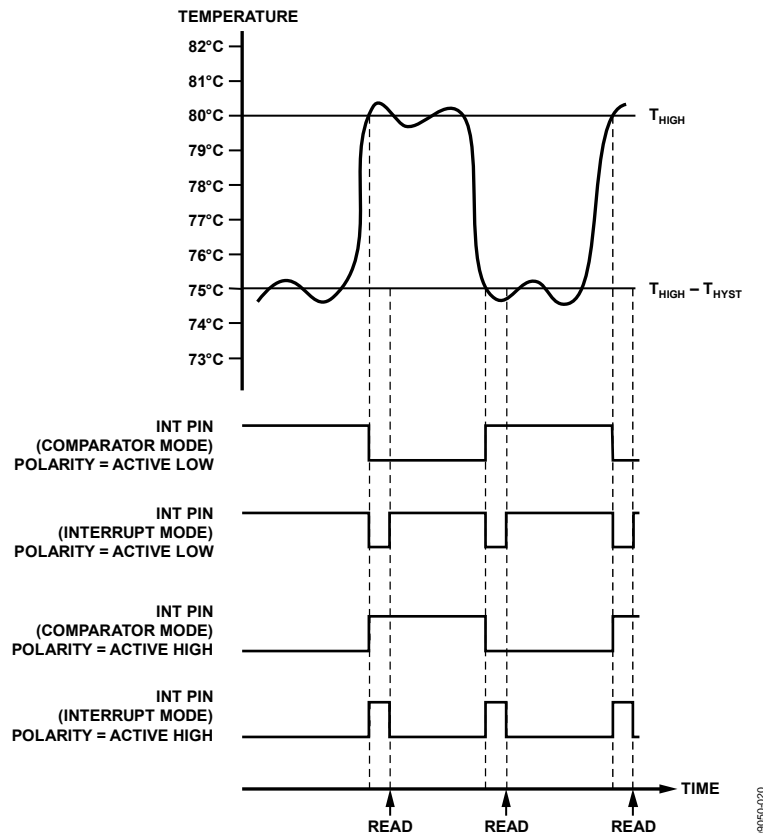

Figure 19. INT Output Temperature Response Diagram for T_{HIGH} Overtemperature Events

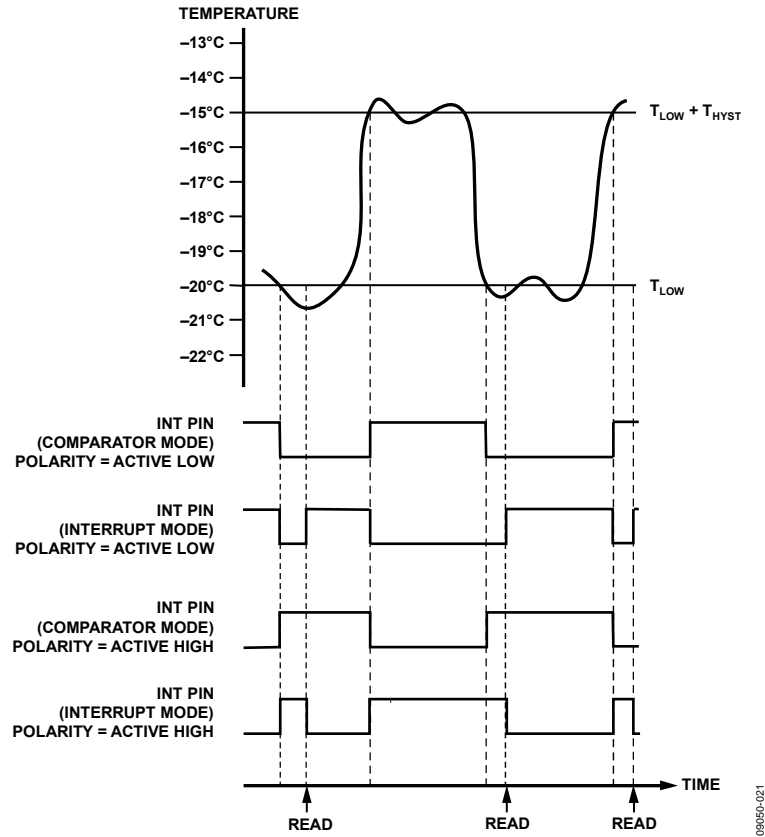

Figure 20. INT Output Temperature Response Diagram for T_{Low} Undertemperature Events

APPLICATIONS INFORMATION

THERMAL RESPONSE TIME

Thermal response is a function of the thermal mass of the temperature sensor, but it is also heavily influenced by the mass of the object the IC is mounted to. For example, a large PCB containing large amounts of copper tracking can act as a large heat sink and slow the thermal response. For a faster thermal response, it is recommended to mount the sensor on as small a PCB as possible.

SUPPLY DECOUPLING

The [ADT7311](#) must have a decoupling capacitor connected between V_{DD} and GND; otherwise, incorrect temperature readings will be obtained. A 0.1 μF decoupling capacitor, such as a high frequency ceramic type, must be used and mounted as close as possible to the V_{DD} pin of the [ADT7311](#).

If possible, the [ADT7311](#) should be powered directly from the system power supply. This arrangement, shown in Figure 21, isolates the analog section from the logic-switching transients. Even if a separate power supply trace is not available, generous supply bypassing reduces supply line induced errors. Local supply bypassing consisting of a 0.1 μF ceramic capacitor is critical for the temperature accuracy specifications to be achieved.

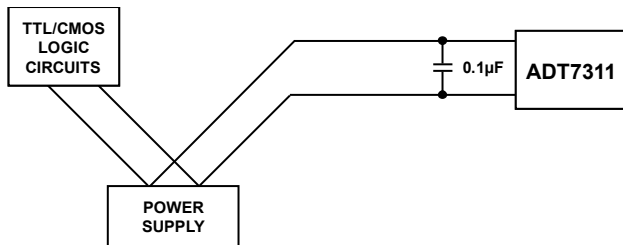

Figure 21. Use of Separate Traces to Reduce Power Supply Noise

POWERING FROM A SWITCHING REGULATOR

Precision analog devices such as the [ADT7311](#) require a well-filtered power source. If the [ADT7311](#) is powered from a switching regulator, noise may be generated in the 50 kHz to 3 MHz range that may affect the temperature accuracy specification. To prevent this, it is recommended to connect an RC filter between the power supply and V_{DD} . The value of components used should be carefully considered to ensure that the

[ADT7311](#) operates within specification. The RC filter should be mounted as far away as possible from the [ADT7311](#) to ensure that the thermal mass is kept as low as possible. For additional information, contact Analog Devices.

TEMPERATURE MONITORING

The [ADT7311](#) is ideal for monitoring the thermal environment within hazardous automotive applications. The die accurately reflects the thermal conditions that affect nearby integrated circuits.

The [ADT7311](#) measures and converts the temperature at the surface of its own semiconductor chip. When the [ADT7311](#) is used to measure the temperature of a nearby heat source, the thermal impedance between the heat source and the [ADT7311](#) must be considered.

When the thermal impedance is determined, the temperature of the heat source can be inferred from the [ADT7311](#) output. As much as 60% of the heat transferred from the heat source to the thermal sensor on the [ADT7311](#) die is discharged via the copper tracks and the bond pads. Of the pads on the [ADT7311](#), the GND pad transfers most of the heat. Therefore, to measure the temperature of a heat source, it is recommended that the thermal resistance between the [ADT7311](#) GND pad and the GND of the heat source be reduced as much as possible.

QUICK GUIDE TO MEASURING TEMPERATURE

1. After power-up, reset the serial interface (load 32 consecutive 1s on DIN). This ensures all internal circuitry is properly initialized.
2. Verify the setup by reading the device ID (Register Address 0x03). It should read 0xC3.
3. After consistent consecutive readings are obtained from Step 2, proceed to read the configuration register (0x01), T_{CRIT} (0x04), T_{HIGH} (0x06), and T_{LOW} (0x07). Compare to the specified defaults in Table 6. If all the readings match, the interface is operational.
4. Write to the configuration register to set the [ADT7311](#) to the desired configuration. Read the temperature value register. It should produce a valid temperature measurement.

OUTLINE DIMENSIONS

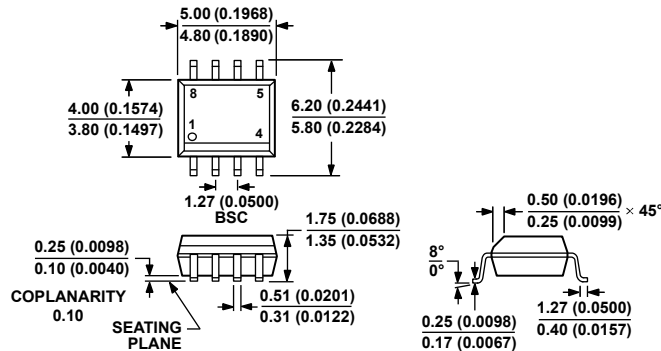

COMPLIANT TO JEDEC STANDARDS MS-012-AA
 CONTROLLING DIMENSIONS ARE IN MILLIMETERS; INCH DIMENSIONS
 (IN PARENTHESES) ARE ROUNDED-OFF MILLIMETER EQUIVALENTS FOR
 REFERENCE ONLY AND ARE NOT APPROPRIATE FOR USE IN DESIGN.

Figure 22. 8-Lead Standard Small Outline Package [SOIC_N]
 Narrow Body
 (R-8)

Dimensions shown in millimeters and (inches)

012407-A

ORDERING GUIDE

Model ^{1, 2}	Temperature Range ³	Temperature Accuracy ⁴	Package Description	Package Option
ADT7311WTRZ	-40°C to +150°C	±0.5°C	8-Lead SOIC_N	R-8
ADT7311WTRZ-RL	-40°C to +150°C	±0.5°C	8-Lead SOIC_N	R-8
ADT7311WTRZ-RL7	-40°C to +150°C	±0.5°C	8-Lead SOIC_N	R-8
EVAL-ADT7X10EBZ			Evaluation Board	

¹ Z = RoHS Compliant Part.

² W = Qualified for Automotive Applications.

³ Operating at extended temperatures over prolonged periods depends on the lifetime performance of the part.

⁴ Maximum accuracy over the -40°C to +105°C temperature range (V_{DD} = 2.7 V to 3.6 V)

AUTOMOTIVE PRODUCTS

The [ADT7311W](#) models are available with controlled manufacturing to support the quality and reliability requirements of automotive applications. Note that these automotive models may have specifications that differ from the commercial models; therefore, designers should review the Specifications section of this data sheet carefully. Only the automotive grade products shown are available for use in automotive applications. Contact your local Analog Devices account representative for specific product ordering information and to obtain the specific Automotive Reliability reports for these models.

NOTES