

System Power Supply for TV Series

Built-in 1ch FET Light Load Type DC / DC converters



BD8622EFV

No.09034EAT04

●Description

BD8622EFV has realized the high performance and reliability required as a power supply for thin-screen TV. Due to the high-speed load response, it is most suitable for TV-purpose processors with increasingly high performance, and due to the wide phase margin it leaves a good margin for board pattern & constant setting and so facilitates its application design.

As a high-reliability design, it has various built-in protection circuits (overcurrent protection, output voltage abnormal protection, thermal protection, and off-latch function at the time of abnormality etc.), therefore as an advantage it does not easily damage in every possible abnormal condition such as all-pin short circuit test etc. and hence most suitable for thin-screen TV which requires the high reliability.

●Features

- 1) High efficiency in all load area
- 2) 3.0A output current
- 3) PWM mode/PFM mode switch (automatic operation)
- 4) Low current mode/Ripple mode switch with terminal MODE
- 5) Low RDS(ON) internal switches: 75mΩ (typ.)
- 6) ±1% reference voltage accuracy
- 7) Programmable frequency : 250kHz-1MHz
(Can the adjustment by an external synchronization and the terminal RT resistance.)
- 8) Terminal RT OPEN/SHORT detecting function
- 9) Over current protection function
- 10) Output over voltage/low voltage protection function (over : $FB > VREF + 60mV$, low : $FB < VREF - 60mV$)
- 11) Timer off latch function in abnormal circumstances
- 12) Thermal shutdown function
- 13) Under voltage protection
- 14) Soft start/start delay circuit
- 15) Soft start time out function
- 16) Protecting BUS function with terminal PDET
- 17) HTSSOP-B20 package

●Electrical characteristics

(Unless otherwise noted Ta=25°C, VIN=3.3V, GND=0V)

Parameter	Symbol	Specification value			UNIT	Condition
		MIN	TYP	MAX		
VIN supply current (operating)	I_{Q_active}	-	210	350	μA	$V_{FB} = 0.83V, V_{FC} = 1V$
VIN supply current (standby)	I_{Q_stby}	-	0	1	μA	$V_{EN} = 0V$
Reference voltage (VREF)	V_{REF}	0.792	0.8	0.808	V	
Output rise detection voltage	V_{OVP}	30	60	90	mV	Monitoring FB terminal
Output decrease detection voltage	V_{LVP}	-90	-60	-30	mV	Monitoring FB terminal
Terminal PDET output current	I_{PDET}	0.4	-	-	mA	$V_{PDET} < 0.3V$
Oscillation frequency	f_{OSC}	500	550	600	kHz	$R_{RT} = 220k\Omega$
Pch FET ON resistance	R_{PFET}	-	75	110	mΩ	$I_{SW} = 1A$
UVLO voltage	V_{UVLO}	2.35	2.50	2.65	V	
SW leak current	I_{LSW}	-	0	1	μA	$V_{EN} = 0V, V_{IN} = 5.5V$
EN terminal H threshold voltage	V_{ENH}	1.1	-	-	V	
EN terminal L threshold voltage	V_{ENL}	-	-	0.4	V	
FC sink current	I_{FCSI}	10	20	-	μA	
FC source current	I_{FCSSO}	-	-20	-10	μA	
SS/DELAY terminal source current	I_{SSSO}	2	4	6	μA	
Terminal PDET pull-up resistor	R_{PDET}	100	170	250	kΩ	

V_{FB} :FB terminal voltage, V_{EN} :EN terminal voltage, V_{FC} :FC terminal voltage, V_{PDET} : PDET terminal voltage
Current capability should not exceed Pd.

●Block diagram

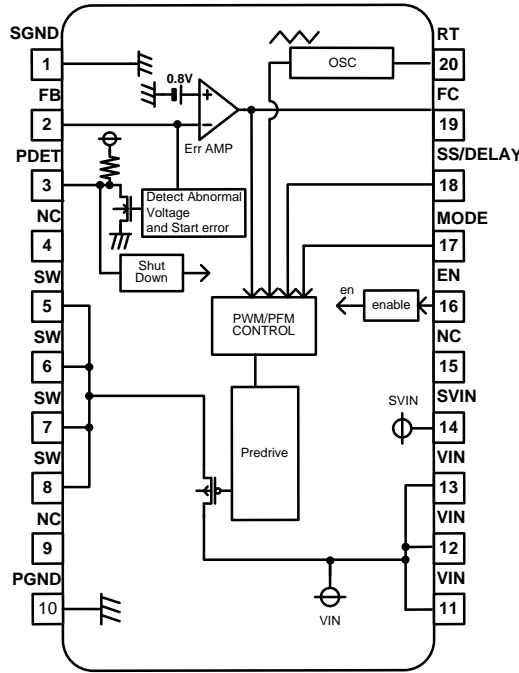

Fig1 Block diagram

●Pin Description

No.	Symbol	Description	Explanation
1	SGND	Signal GND terminal	Small signal system GND
2	FB	Feed back terminal	Output voltage detection
3	PDET	Abnormal state notification and external IC abnormality detection terminal	Protecting BUS communication terminal
4	NC		
5	SW	Switching output terminal	
6	SW		
7	SW		
8	SW		
9	NC		
10	PGND	Power GND terminal	GND for power MOSFET
11	VIN	Power supply input terminal	Power supply input. The decoupling is done to PGND
12	VIN		
13	VIN		
14	VIN		
15	NC		
16	EN	Enable input	ON/OFF control for device operation
17	MODE	MODE selection terminal	The operation mode is switched according to the input voltage at a light load.
18	SS/DELAY	Soft start adjustment capacity connection terminal	The soft start time is adjusted with the connected capacitor
19	FC	Error amplifier output	Error amplifier phase compensation point
20	RT	Frequency adjustment resistance connection terminal	The switching frequency is set by the connected resistance

●Pin equivalence circuit diagram

No.	Symbol	Explanation	Terminal equivalent circuit diagram
1	SGND	GND (connected 0V)	
2	FB	Output voltage detection terminal	
3	PDET	Protecting BUS I/O terminal	
5,6,7,8	SW	Output terminal	
10	PGND	Power GND (Same voltage as SGND)	
11,12,13	PVIN	Power supply input terminal	
14	SVIN	Power supply input terminal	

No.	Symbol	Explanation	Terminal equivalent circuit diagram
16	EN	Enable terminal	
17	MODE	Operation mode switch terminal at light load	

No.	Symbol	Explanation	Terminal equivalent circuit diagram
18	SS /DELAY	Soft start time adjustment terminal	
19	FC	Error amplifier compensation terminal	
20	RT	Oscillator frequency adjustment terminal	

● Operation description

Enable control

The device can be controlled ON/OFF by EN terminal (16 pin) voltage.

An internal circuit starts when VEN reaches 1.1V.

When standing up of VIN is too steep (1msec or less), a defective start might be caused according to the state of Pascon between GND substrate pattern and power supply-when the terminal EN is short-circuited to the terminal VIN and it is used.

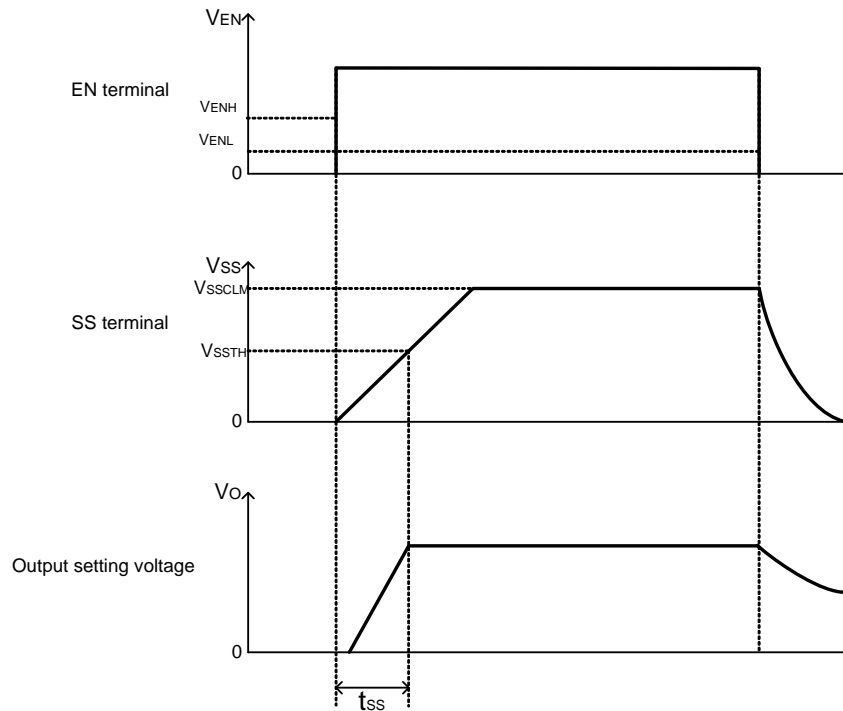

Fig.2 ON/OFF transition wave form in EN controlling

Soft start time set function

As for BD8622EFV, output can do soft start without overshoot by charging soft start capacity (CSS) connected between SS and SGND terminal.

Also, soft start time (tss) can be set by setting soft start capacity (CSS) arbitrarily.

OSC oscillation frequency setting function

The output oscillation frequency can be set by connecting resistance between terminal RT (20 pins) and SGND (range = 250kHz - 1MHz)

The relation between RT terminal resistance and the oscillation frequency follows Fig.4.

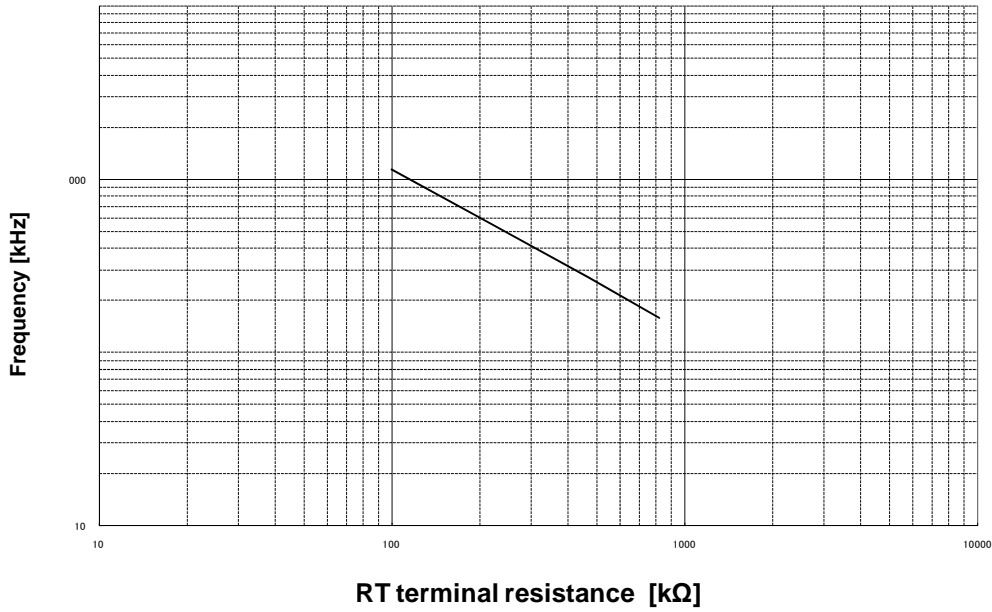

Fig.4 RT resistance-oscillation frequency

Light load mode operation

- Low current mode

When the terminal MODE (17 pins) is made "H", low current mode operation becomes effective. The characteristic of the efficiency valuing is obtained in low current mode operation at a light load.

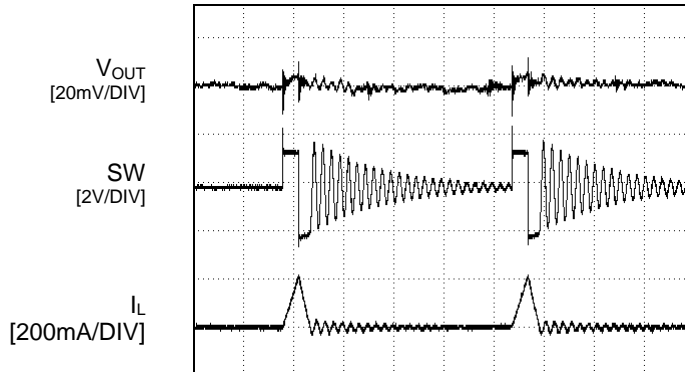

Fig.5 Low current mode operation

- Low ripple mode

When the terminal MODE is made "L", the Low ripple mode operation becomes effective. It becomes operation of valuing a low ripple in the Low ripple mode operation at a light load.

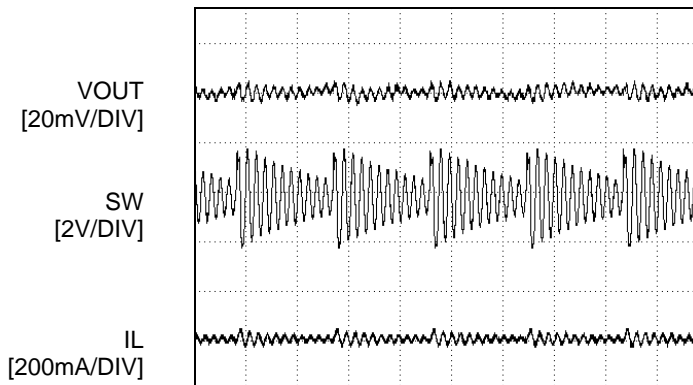

Fig.6 Low ripple mode operation

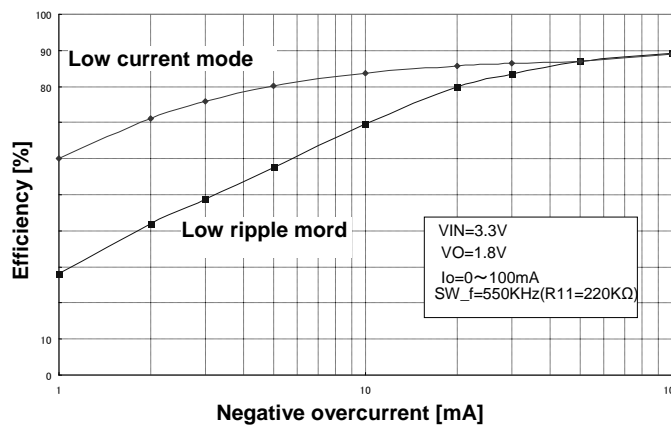

Fig7 Light load mode efficiency comparison

● Protection function

Protection circuit is effective for destruction prevention due to accident so that avoid using under continuous protection operation.

Low voltage protection function (LVP)

The voltage of the terminal FB (2 pins) is compared with internal reference voltage VREF. If FB terminal voltage falls below $V_{LVP}(= VREF - 60mV)$ and the state continues for 500us, output changes to low voltage and the state is fixed. In that case , PDET (3pin) output changes to L.

Table 1 output low voltage protection function

EN terminal	SS terminal	FB terminal	Low voltage protection function	Low voltage protection operation
$>V_{ENH}$	$>1.4V(typ)$	$<V_{LVP}$	Effective	ON
		$>V_{LVP}$		OFF
	$<1.4V(typ)$	-	Invalidity	OFF
$<V_{ENL}$	-	-	Invalidity	OFF

* Low voltage protection function is available when SS terminal voltage becomes more than 1.4V (typ) in the transition to ON control (during soft start).

Over voltage protection function(OVP)

The voltage of the terminal FB is compared with internal reference voltage VREF. If FB terminal voltage is over $V_{ovp}(=VREF + 60mV)$ and the state is continues for 500usec, output changes to low voltage and the state is fixed.

Table 2 output overvoltage protection function

EN terminal	SS terminal	FB terminal	Over voltage protection function	Over voltage protection operation
$>V_{ENH}$	$>1.4V(typ)$	$>V_{OVP}$	Effective	ON
		$<V_{OVP}$		OFF
	$<1.4V(typ)$	-	Invalidity	OFF
$<V_{ENL}$	-	-	Invalidity	OFF

* Over voltage protection function is available when SS terminal voltage becomes more than 1.4V (typ) in the transition to ON control (during soft start).

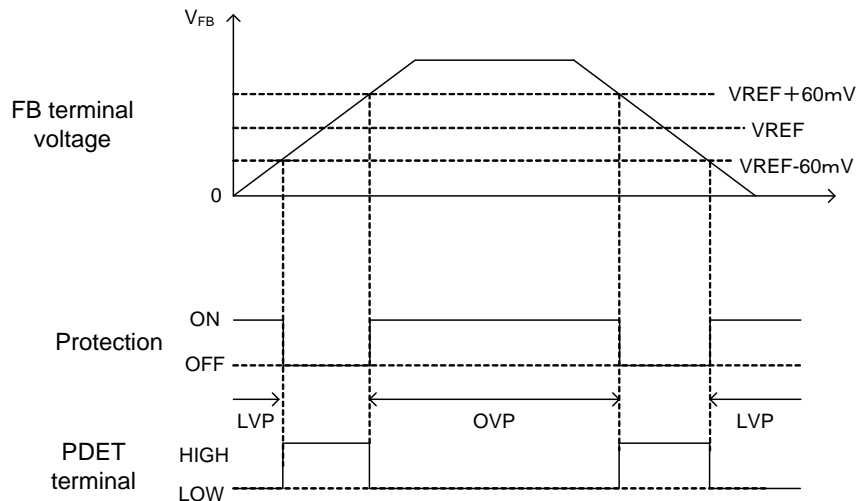

Fig.8 Output voltage error detection range

Under voltage lock out protection (UVLO)

As for BD8622EFV, the power-supply voltage decrease detection protection circuit is built in.

If the input voltage decrease below the UVLO voltage (2.5V typ), the device state changes to the standby mode (Moreover, to prevent the chattering of the output) hysteresis width of 100mV(typ) has been installed in the UVLO cancel voltage.

RT terminal open/short protection function (RTO/RTS)

RT terminal opening/short protection function prevent the clock from abnormal oscillation.

If RT terminal open/short protection function is detected, output voltage changes to low level and is fixed.

Terminal RT opening/short protection function is available if the state continue for 500usec, abnormal detection operates when the state continues about 500µsec(typ).

Soft start time-out function

If VSS doesn't exceed VSSTH within 64msec (typ) since a soft start began, BD8622EFV controls an off latch.

Vo is fixed in a low level.

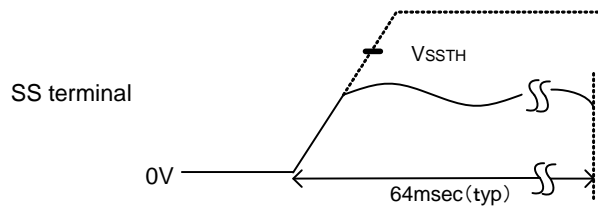

Fig.9 Soft start time-out

Thermal shut down function

Thermal shut down circuit (TSD circuit) is built into BD8622EFV. When the temperature of the chip exceeds $T_{jmax}=175$, the DC/DC converter is fixed in a low voltage.

TSD function is aimed to shut down IC from thermal reckless driving under an abnormal state to exceed $T_{jmax}=175$.

It aims at neither protection nor the guarantee of the set. Therefore, please do not use this function to protect the set.

Over current protection function

The over current protection function has been achieved by limiting the current that flows on high side MOSFET.

The current is controlled in every one cycle of the switching frequency. When an abnormal state continues for about 500µsec(typ), the output is fixed in a low level.

Protecting BUS function with terminal PDET

The terminal PDET (3 pins) monitors whether IC is normal or not. When IC becomes abnormal, the PDET output is reduced at "L" level with the output voltage fixed "L" level at the same time. Moreover, it is possible to make the output fix in a low level by compulsorily reducing the terminal PDET at "L" level from the outside.

When two or more BD8622EFV is used in the application, this function prevents the IC from destroying, because one IC error transmits all other ICs by PDET line in the condition that PDET terminals are connected each other.

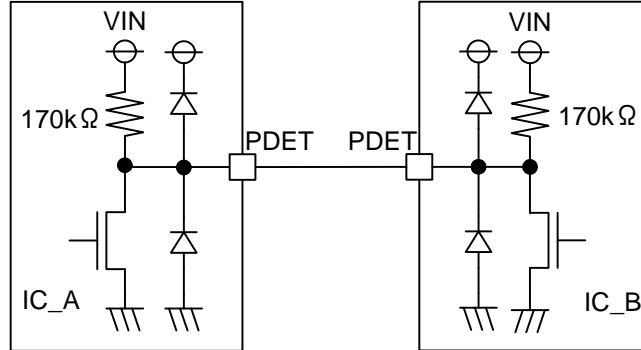

Fig.10 Protecting BUS communication

※Please give the terminal PDET as OPEN when you do not use protecting BUS function.

Error detection (off latch) release method

BD8622EFV enters the state of an off latch when the protection function operates.

To release the off latch state, EN terminal voltage should be changed to low level once time.

● Each characteristic reference data

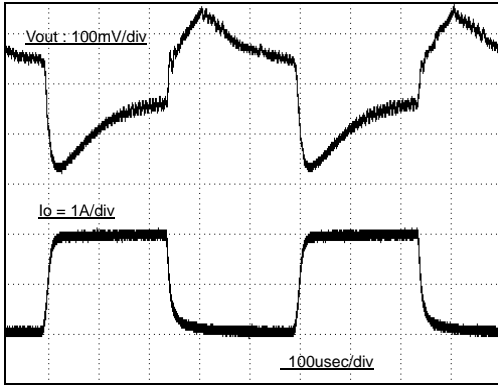

Fig.11 Output load response

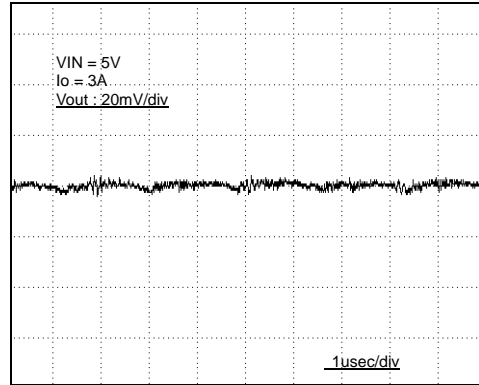

Fig.12 Output ripple

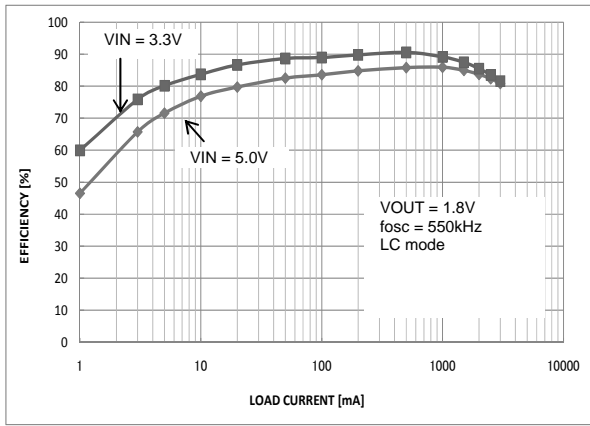

Fig.13 Efficiency

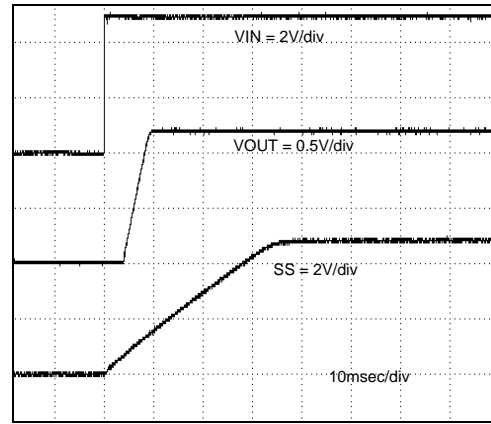

Fig.14 Soft start

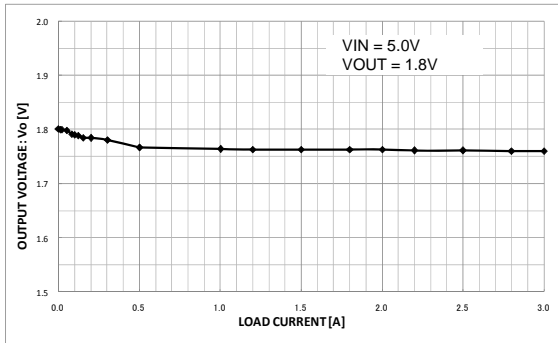

Fig.15 Regulation

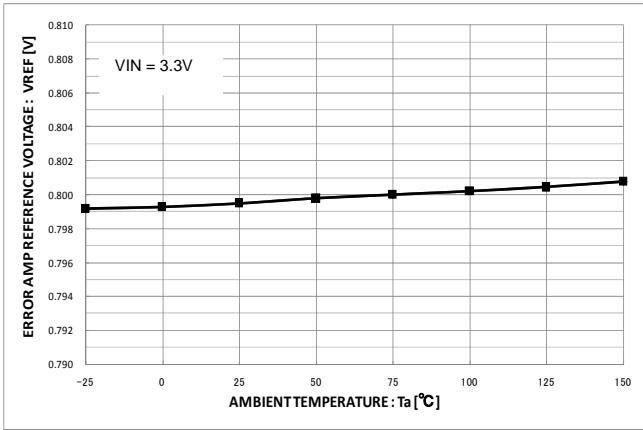

Fig.16 Reference voltage - Temperature characteristic

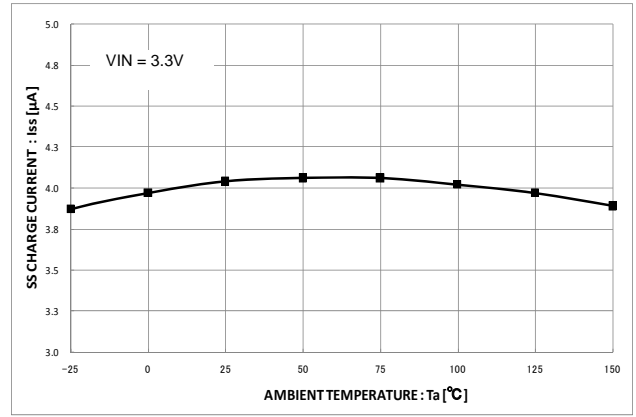

Fig.17 SS Charging current - Temperature characteristic

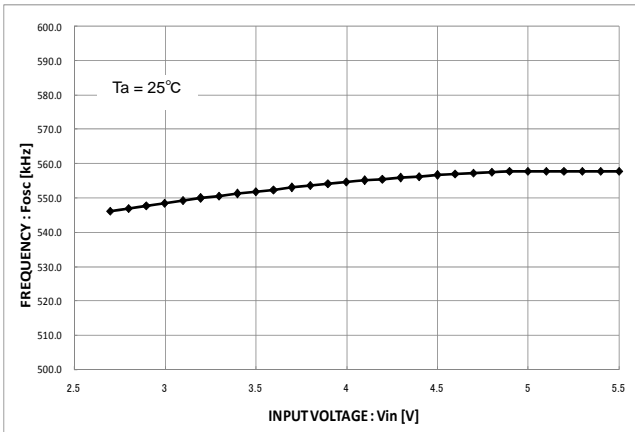

Fig.18 Switching frequency-power-supply voltage

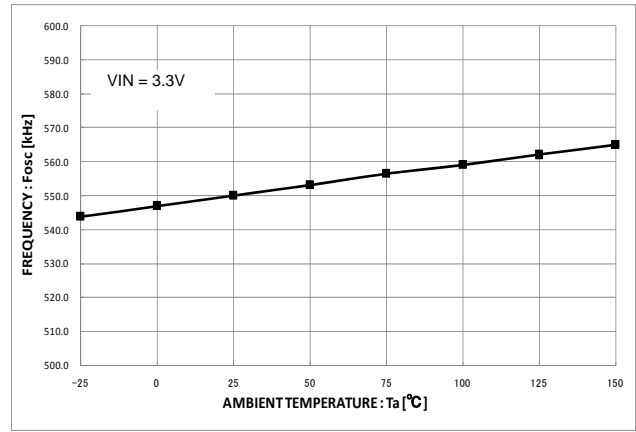

Fig.19 Switching frequency-temperature characteristic

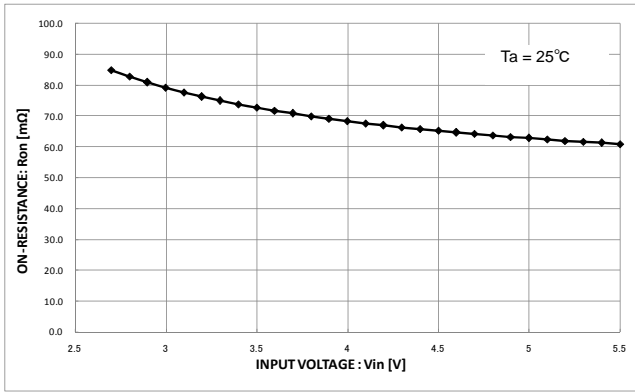

Fig.20 PMOS on resistance-power-supply voltage

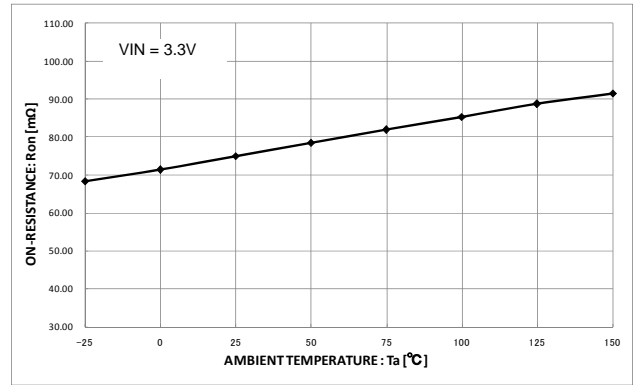

Fig.21 PMOS on resistance-temperature characteristic

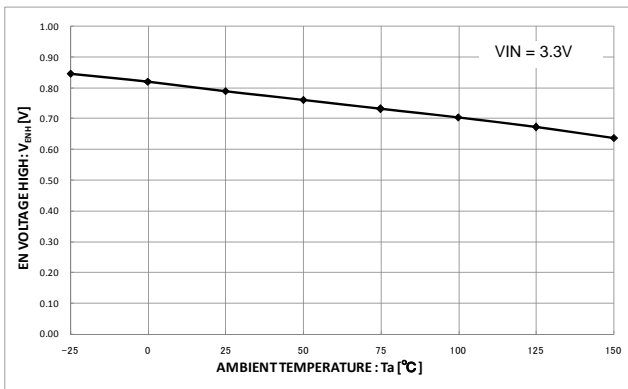

Fig.22 Terminal EN H voltage-temperature characteristic

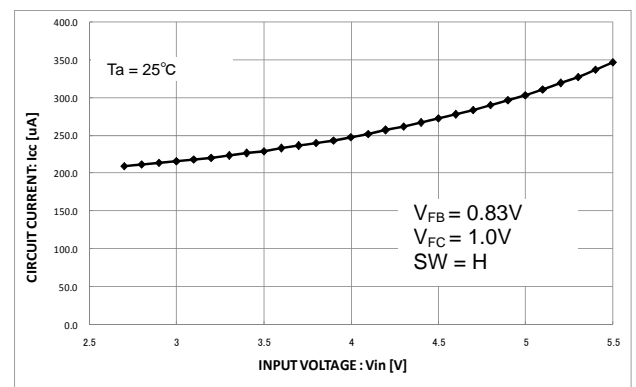

Fig.23 Circuit current-power-supply voltage characteristic

●Ordering part number

B	D
---	---

Part No

8	6	2	2
---	---	---	---

Part No.

E	F	V
---	---	---

Package
EFV: HTSSOP-B20

E	2
---	---

Packaging and forming specification
E2: Embossed tape and reel

HTSSOP-B20

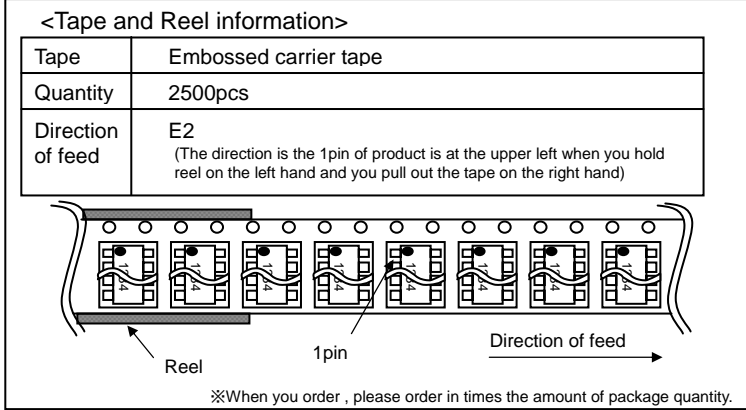
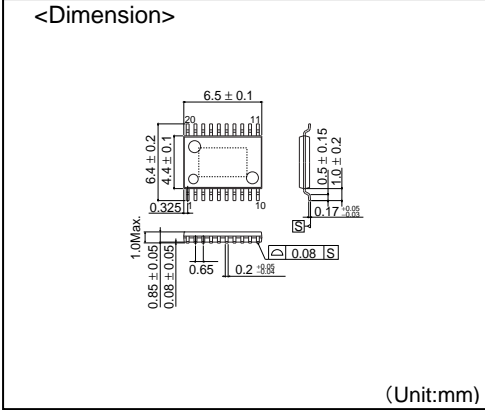

Notice

Precaution on using ROHM Products

- Our Products are designed and manufactured for application in ordinary electronic equipments (such as AV equipment, OA equipment, telecommunication equipment, home electronic appliances, amusement equipment, etc.). If you intend to use our Products in devices requiring extremely high reliability (such as medical equipment ^(Note 1), transport equipment, traffic equipment, aircraft/spacecraft, nuclear power controllers, fuel controllers, car equipment including car accessories, safety devices, etc.) and whose malfunction or failure may cause loss of human life, bodily injury or serious damage to property ("Specific Applications"), please consult with the ROHM sales representative in advance. Unless otherwise agreed in writing by ROHM in advance, ROHM shall not be in any way responsible or liable for any damages, expenses or losses incurred by you or third parties arising from the use of any ROHM's Products for Specific Applications.

(Note1) Medical Equipment Classification of the Specific Applications

JAPAN	USA	EU	CHINA
CLASS III	CLASS III	CLASS II b	CLASS III
CLASS IV		CLASS III	

- ROHM designs and manufactures its Products subject to strict quality control system. However, semiconductor products can fail or malfunction at a certain rate. Please be sure to implement, at your own responsibilities, adequate safety measures including but not limited to fail-safe design against the physical injury, damage to any property, which a failure or malfunction of our Products may cause. The following are examples of safety measures:
 - Installation of protection circuits or other protective devices to improve system safety
 - Installation of redundant circuits to reduce the impact of single or multiple circuit failure
- Our Products are designed and manufactured for use under standard conditions and not under any special or extraordinary environments or conditions, as exemplified below. Accordingly, ROHM shall not be in any way responsible or liable for any damages, expenses or losses arising from the use of any ROHM's Products under any special or extraordinary environments or conditions. If you intend to use our Products under any special or extraordinary environments or conditions (as exemplified below), your independent verification and confirmation of product performance, reliability, etc. prior to use, must be necessary:
 - Use of our Products in any types of liquid, including water, oils, chemicals, and organic solvents
 - Use of our Products outdoors or in places where the Products are exposed to direct sunlight or dust
 - Use of our Products in places where the Products are exposed to sea wind or corrosive gases, including Cl₂, H₂S, NH₃, SO₂, and NO₂
 - Use of our Products in places where the Products are exposed to static electricity or electromagnetic waves
 - Use of our Products in proximity to heat-producing components, plastic cords, or other flammable items
 - Sealing or coating our Products with resin or other coating materials
 - Use of our Products without cleaning residue of flux (even if you use no-clean type fluxes, cleaning residue of flux is recommended); or Washing our Products by using water or water-soluble cleaning agents for cleaning residue after soldering
 - Use of the Products in places subject to dew condensation
- The Products are not subject to radiation-proof design.
- Please verify and confirm characteristics of the final or mounted products in using the Products.
- In particular, if a transient load (a large amount of load applied in a short period of time, such as pulse. is applied, confirmation of performance characteristics after on-board mounting is strongly recommended. Avoid applying power exceeding normal rated power; exceeding the power rating under steady-state loading condition may negatively affect product performance and reliability.
- De-rate Power Dissipation (Pd) depending on Ambient temperature (Ta). When used in sealed area, confirm the actual ambient temperature.
- Confirm that operation temperature is within the specified range described in the product specification.
- ROHM shall not be in any way responsible or liable for failure induced under deviant condition from what is defined in this document.

Precaution for Mounting / Circuit board design

- When a highly active halogenous (chlorine, bromine, etc.) flux is used, the residue of flux may negatively affect product performance and reliability.
- In principle, the reflow soldering method must be used; if flow soldering method is preferred, please consult with the ROHM representative in advance.

For details, please refer to ROHM Mounting specification

Precautions Regarding Application Examples and External Circuits

1. If change is made to the constant of an external circuit, please allow a sufficient margin considering variations of the characteristics of the Products and external components, including transient characteristics, as well as static characteristics.
2. You agree that application notes, reference designs, and associated data and information contained in this document are presented only as guidance for Products use. Therefore, in case you use such information, you are solely responsible for it and you must exercise your own independent verification and judgment in the use of such information contained in this document. ROHM shall not be in any way responsible or liable for any damages, expenses or losses incurred by you or third parties arising from the use of such information.

Precaution for Electrostatic

This Product is electrostatic sensitive product, which may be damaged due to electrostatic discharge. Please take proper caution in your manufacturing process and storage so that voltage exceeding the Products maximum rating will not be applied to Products. Please take special care under dry condition (e.g. Grounding of human body / equipment / solder iron, isolation from charged objects, setting of ionizer, friction prevention and temperature / humidity control).

Precaution for Storage / Transportation

1. Product performance and soldered connections may deteriorate if the Products are stored in the places where:
 - [a] the Products are exposed to sea winds or corrosive gases, including Cl₂, H₂S, NH₃, SO₂, and NO₂
 - [b] the temperature or humidity exceeds those recommended by ROHM
 - [c] the Products are exposed to direct sunshine or condensation
 - [d] the Products are exposed to high Electrostatic
2. Even under ROHM recommended storage condition, solderability of products out of recommended storage time period may be degraded. It is strongly recommended to confirm solderability before using Products of which storage time is exceeding the recommended storage time period.
3. Store / transport cartons in the correct direction, which is indicated on a carton with a symbol. Otherwise bent leads may occur due to excessive stress applied when dropping of a carton.
4. Use Products within the specified time after opening a humidity barrier bag. Baking is required before using Products of which storage time is exceeding the recommended storage time period.

Precaution for Product Label

QR code printed on ROHM Products label is for ROHM's internal use only.

Precaution for Disposition

When disposing Products please dispose them properly using an authorized industry waste company.

Precaution for Foreign Exchange and Foreign Trade act

Since our Products might fall under controlled goods prescribed by the applicable foreign exchange and foreign trade act, please consult with ROHM representative in case of export.

Precaution Regarding Intellectual Property Rights

1. All information and data including but not limited to application example contained in this document is for reference only. ROHM does not warrant that foregoing information or data will not infringe any intellectual property rights or any other rights of any third party regarding such information or data. ROHM shall not be in any way responsible or liable for infringement of any intellectual property rights or other damages arising from use of such information or data.:
2. No license, expressly or implied, is granted hereby under any intellectual property rights or other rights of ROHM or any third parties with respect to the information contained in this document.

Other Precaution

1. This document may not be reprinted or reproduced, in whole or in part, without prior written consent of ROHM.
2. The Products may not be disassembled, converted, modified, reproduced or otherwise changed without prior written consent of ROHM.
3. In no event shall you use in any way whatsoever the Products and the related technical information contained in the Products or this document for any military purposes, including but not limited to, the development of mass-destruction weapons.
4. The proper names of companies or products described in this document are trademarks or registered trademarks of ROHM, its affiliated companies or third parties.

General Precaution

1. Before you use our Products, you are requested to carefully read this document and fully understand its contents. ROHM shall not be in any way responsible or liable for failure, malfunction or accident arising from the use of any ROHM's Products against warning, caution or note contained in this document.
2. All information contained in this document is current as of the issuing date and subject to change without any prior notice. Before purchasing or using ROHM's Products, please confirm the latest information with a ROHM sales representative.
3. The information contained in this document is provided on an "as is" basis and ROHM does not warrant that all information contained in this document is accurate and/or error-free. ROHM shall not be in any way responsible or liable for any damages, expenses or losses incurred by you or third parties resulting from inaccuracy or errors of or concerning such information.