



## Main

Range of Product	Zelio Logic
Product or Component Type	Discrete I/O extension module

## Complementary

Number of control scheme lines	120 ladder
Cycle time	6...90 ms
Backup time	10 years 77 °F (25 °C)
Clock drift	12 min/year 32...131 °F (0...55 °C)
Checks	Program memory on each power up
[Us] rated supply voltage	24 V DC
Supply voltage limits	19.2...30 V
Reverse polarity protection	With
Discrete input number	6 EN/IEC 61131-2 type 1
Discrete input type	Resistive
Discrete input voltage	24 V DC
Discrete input current	4 mA
Counting frequency	1 kHz discrete input
Voltage state 1 guaranteed	>= 15 V I1...IA and IH...IR discrete input circuit >= 15 V IB...IG used as discrete input circuit
Voltage state 0 guaranteed	<= 5 V I1...IA and IH...IR discrete input circuit <= 5 V IB...IG used as discrete input circuit
Current state 1 guaranteed	>= 1.2 mA IB...IG used as discrete input circuit) >= 2.2 mA I1...IA and IH...IR discrete input circuit)
Current state 0 guaranteed	<= 0.5 mA IB...IG used as discrete input circuit) <= 0.75 mA I1...IA and IH...IR discrete input circuit)
Input compatibility	3-wire proximity sensors PNP discrete input
Input impedance	12 kOhm IB...IG used as discrete input circuit 7.4 kOhm I1...IA and IH...IR discrete input circuit
Number of Outputs	4 relay
Output voltage limits	24...250 V AC relay output) 5...30 V DC relay output)
Contacts type and composition	NO relay output
Output thermal current	8 A for all 4 outputs relay output
Electrical durability	AC-15 500000 cycles 230 V, 0.9 A relay output EN/IEC 60947-5-1 AC-12 500000 cycles 230 V, 1.5 A relay output EN/IEC 60947-5-1 DC-13 500000 cycles 24 V, 0.6 A relay output EN/IEC 60947-5-1 DC-12 500000 cycles 24 V, 1.5 A relay output EN/IEC 60947-5-1
Switching capacity in mA	>= 10 mA 12 V relay output)
Operating rate in Hz	0.1 Hz at Ie)relay output 10 Hz no load)relay output
Mechanical durability	10000000 cycles relay output

[Uimp] rated impulse withstand voltage	4 kV EN/IEC 60947-1 and EN/IEC 60664-1
Response time	10 ms from state 0 to state 1)relay output 5 ms from state 1 to state 0)relay output
Connections - terminals	Screw terminals, 1 x 0.25...1 x 2.5 mm <sup>2</sup> AWG 24...AWG 14) flexible with cable end Screw terminals, 2 x 0.25...2 x 0.75 mm <sup>2</sup> AWG 24...AWG 18) flexible with cable end Screw terminals, 1 x 0.2...1 x 2.5 mm <sup>2</sup> AWG 25...AWG 14) semi-solid Screw terminals, 1 x 0.2...1 x 2.5 mm <sup>2</sup> AWG 25...AWG 14) solid Screw terminals, 2 x 0.2...2 x 1.5 mm <sup>2</sup> AWG 24...AWG 16) solid
Tightening torque	4.43 lbf.in (0.5 N.m)
Overvoltage category	III EN/IEC 60664-1
Net Weight	0.44 lb(US) (0.2 kg)

## Environment

Product Certifications	GL C-tick UL GOST CSA
Standards	EN/IEC 61000-4-4 level 3 EN/IEC 61000-4-2 level 3 EN/IEC 61000-4-3 EN/IEC 61000-4-12 EN/IEC 61000-4-11 EN/IEC 60068-2-6 Fc EN/IEC 60068-2-27 Ea EN/IEC 61000-4-6 level 3 EN/IEC 61000-4-5
IP degree of protection	IP20 IEC 60529 terminal block) IP40 IEC 60529 front panel)
Environmental characteristic	EMC directive EN/IEC 61000-6-2 EMC directive EN/IEC 61000-6-3 EMC directive EN/IEC 61000-6-4 EMC directive EN/IEC 61131-2 zone B Low voltage directive EN/IEC 61131-2
Disturbance radiated/conducted	Class B EN 55022-11 group 1
Pollution degree	2 EN/IEC 61131-2
Ambient air temperature for operation	-4...104 °F (-20...40 °C) in non-ventilated enclosure IEC 60068-2-1 and IEC 60068-2-2 -4...131 °F (-20...55 °C) IEC 60068-2-1 and IEC 60068-2-2
Ambient Air Temperature for Storage	-40...158 °F (-40...70 °C)
Operating altitude	6561.68 ft (2000 m)
Maximum altitude transport	10000.00 ft (3048 m)
Relative Humidity	95 % without condensation or dripping water

## Ordering and shipping details

Category	22378 - SR2,3 ZELIO 2 RELAYS
Discount Schedule	I
GTIN	3389110550085
Nbr. of units in pkg.	1
Package weight(Lbs)	6.49 oz (184 g)
Returnability	Yes
Country of origin	FR

## Packing Units

Unit Type of Package 1	PCE
Package 1 Height	2.68 in (6.8 cm)
Package 1 width	3.54 in (9 cm)
Package 1 Length	3.94 in (10 cm)
Unit Type of Package 2	S03
Number of Units in Package 2	30
Package 2 Weight	13.15 lb(US) (5.964 kg)

Package 2 Height	11.81 in (30 cm)
Package 2 width	11.81 in (30 cm)
Package 2 Length	15.75 in (40 cm)

### Offer Sustainability

Sustainable offer status	Green Premium product
California proposition 65	WARNING: This product can expose you to chemicals including: Lead and lead compounds, which is known to the State of California to cause cancer and birth defects or other reproductive harm. For more information go to <a href="http://www.P65Warnings.ca.gov">www.P65Warnings.ca.gov</a>
REACH Regulation	<a href="#">REACH Declaration</a>
EU RoHS Directive	Pro-active compliance (Product out of EU RoHS legal scope) <a href="#">EU RoHS Declaration</a>
Mercury free	Yes
RoHS exemption information	<a href="#">Yes</a>
China RoHS Regulation	<a href="#">China RoHS Declaration</a>
Environmental Disclosure	<a href="#">Product Environmental Profile</a>
Circularity Profile	<a href="#">End Of Life Information</a>
WEEE	The product must be disposed on European Union markets following specific waste collection and never end up in rubbish bins.
PVC free	Yes

### Contractual warranty

Warranty	18 months
----------	-----------

I/O Extension Modules

Mounting on 35 mm/1.38 in. DIN Rail

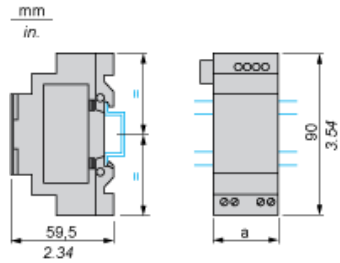

Screw Fixing (Retractable Lugs)

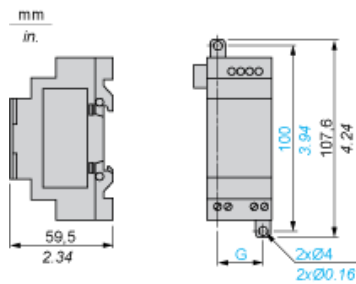

SR3	a (mm/in.)	G (mm/in.)
XT61••	35 / 1.38	25 / 0.98
XT101••	72 / 2.83	60 / 2.36
XT141••	72 / 2.83	60 / 2.36

Communication Modules

Rail Mounting

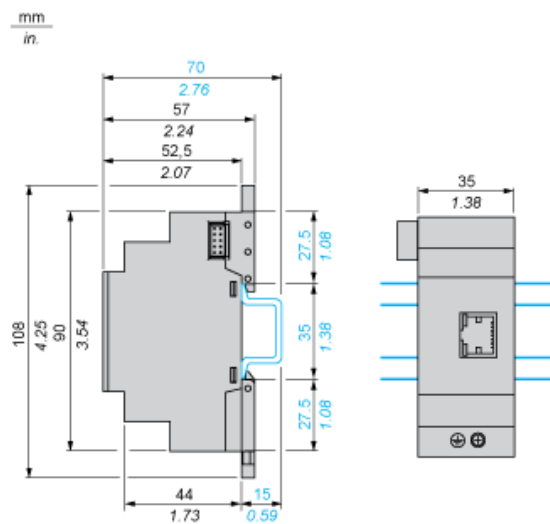

## Screw Mounting (Retractable Lugs)

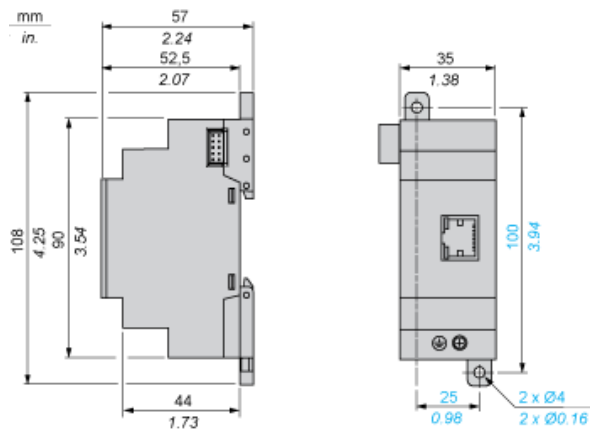

## Connection of Smart Relays on DC Supply, with Discrete I/O Extension Modules

SR3B...JD + SR3XT...JD, SR3B...BD + SR3XT...BD

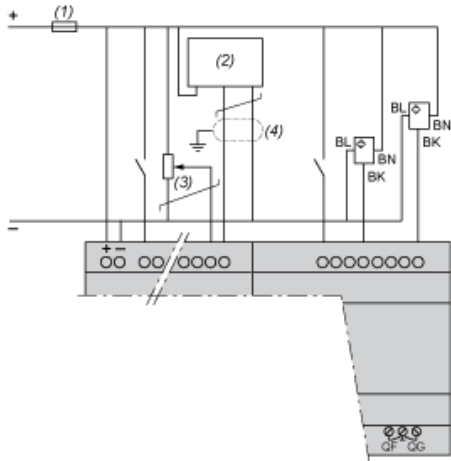

- (1) 1 A quick-blow fuse or circuit-breaker.
- (2) Ca: Analog sensor / Ta: Analog transmitter.
- (3) Recommended values: 2.2 k $\Omega$  / 0.5 W (10 k $\Omega$  max.)
- (4) Screened cables, maximum length 10 m / 32.80 feet.

NOTE: QF and QG : 5 A for SR3XT141\*\*

Compact and Modular Smart Relays

Electrical Durability of Relay Outputs

(in millions of operating cycles, conforming to IEC/EN 60947-5-1)

DC-12 (1)

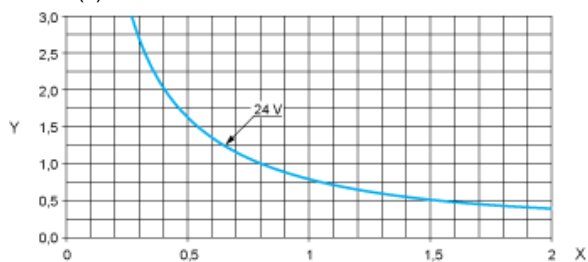

X: Current (A)

Y: Millions of operating cycles

(1) DC-12: control of resistive loads and of solid state loads isolated by opto-coupler,  $L/R \leq 1$  ms.

DC-13 (1)

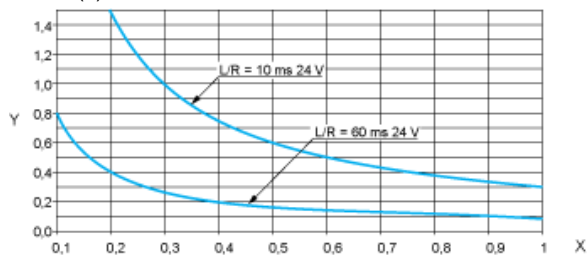

X: Current (A)

Y: Millions of operating cycles

(1) DC-13: switching electromagnets,  $L/R \leq 2 \times (U_e \times I_e)$  in ms,  $U_e$ : rated operational voltage,  $I_e$ : rated operational current (with a protection diode on the load, DC-12 curves must be used with a coefficient of 0.9 applied to the number in millions of operating cycles).