

## LOW NOISE Dual 300mA LDO

NO. EA-131-200525

### OUTLINE

The RP150K Series are CMOS-based dual voltage regulator ICs with high output voltage accuracy, low supply current, low dropout, and high ripple rejection. Each of these voltage regulator ICs consists of a voltage reference unit, an error amplifier, resistors for setting Output Voltage, a current limit circuit, and a chip enable circuit.

These ICs perform with low dropout voltage due to built-in transistor with low ON resistance, and a chip enable function prolongs the battery life of each system. The line transient response and load transient response of the RP150 Series are excellent, thus these ICs are very suitable for the power supply for hand-held communication equipment.

The output voltage of these ICs is internally fixed with high accuracy (1%). Since the packages for these ICs are DFN(PLP)2020-8 package, 2ch LDO regulators are included in each packages, high density mounting of the ICs on boards is possible.

### FEATURES

- Supply Current ..... Typ. 24 $\mu$ A $\times$ 2 (VR1&VR2)
- Standby Current ..... Typ. 0.1 $\mu$ A $\times$ 2 (VR1&VR2)
- Dropout Voltage ..... Typ. 0.21V ( $I_{OUT}$ =300mA,  $V_{OUT}$ =2.8V)  
Typ. 0.24V ( $I_{OUT}$ =300mA,  $V_{OUT}$ =2.5V)
- Ripple Rejection ..... Typ. 80dB (f=1kHz)
- Temperature-Drift Coefficient of Output Voltage ..... Typ.  $\pm$ 30ppm/ $^{\circ}$ C
- Line Regulation ..... Typ. 0.02%/V
- Output Voltage Accuracy .....  $\pm$ 1.0%
- Input Voltage Range ..... 2.5V to 5.25V
- Output Voltage Range ..... 1.5V to 3.3V (0.1V steps)  
(For details, please refer to MARK INFORMATIONS.)
- Package ..... DFN(PLP)2020-8
- Built-in Fold Back Protection Circuit ..... Typ. 50mA
- Built-in Auto Discharge Function ..... B Version
- Ceramic capacitors are recommended to be used with this IC ...  $C_{IN}$ = $C_{OUT}$ =1.0 $\mu$ F or more

### APPLICATIONS

- Power source for portable communication equipment.
- Power source for electrical appliances such as cameras, VCRs and camcorders.
- Power source for battery-powered equipment.

BLOCK DIAGRAMS

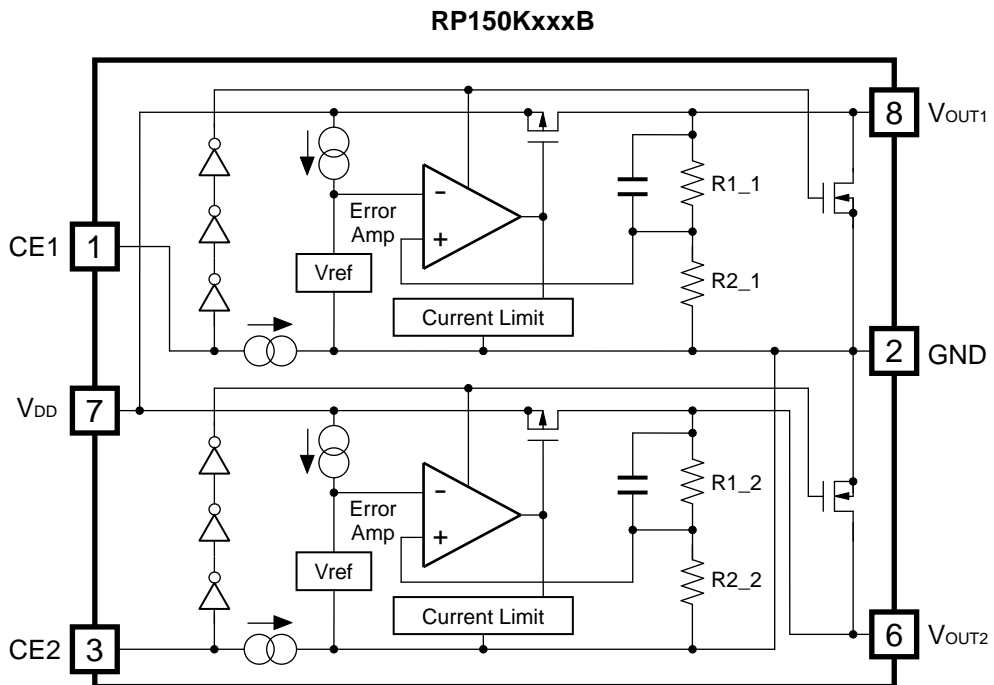
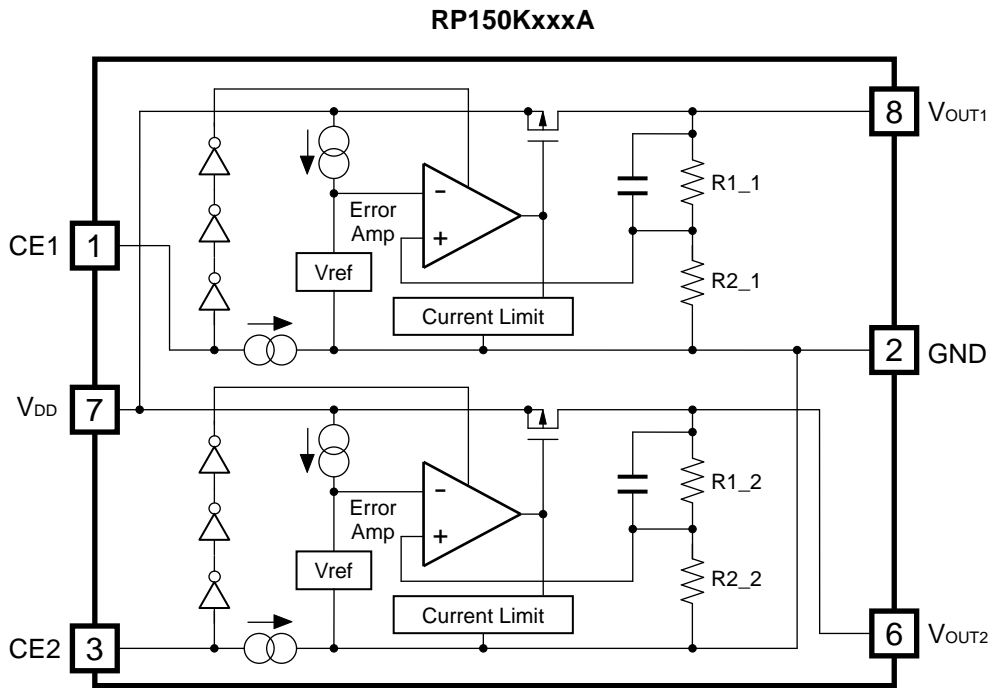

## SELECTION GUIDE

The output voltage, auto discharge function, package, and the taping type, etc. for the ICs can be selected at the user's request.

Product Name	Package	Quantity per Reel	Pb Free	Halogen Free
RP150Kxxx*-TR	DFN(PLP)2020-8	5,000 pcs	Yes	Yes
xxx: The combination of output voltage for each channel can be designated by serial numbers. (from 001) The output voltage for each channel can be set in the range from 1.5V to 3.3V in 0.1V steps. (For details, please refer to MARK INFORMATIONS.)				
* : The auto discharge function at off state are options as follows. (A) without auto-discharge function at off state (B) with auto-discharge function at off state				

## PIN CONFIGURATIONS

### • DFN(PLP)2020-8

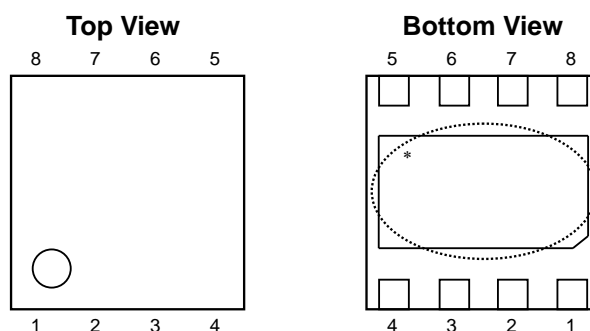

## PIN DESCRIPTIONS

### • DFN(PLP)2020-8

Pin No.	Symbol	Description
1	CE1	Chip Enable Pin 1 ("H" Active)
2	GND	Ground Pin
3	CE2	Chip Enable Pin 2 ("H" Active)
4	NC	No Connection
5	NC	No Connection
6	V <sub>OUT2</sub>	Output Pin 2
7	V <sub>DD</sub>	Input Pin
8	V <sub>OUT1</sub>	Output Pin 1

\*) Tab is GND level. (They are connected to the reverse side of this IC.)

The tab is better to be connected to the GND, but leaving it open is also acceptable.

## ABSOLUTE MAXIMUM RATINGS

Symbol	Item	Rating	Unit
V <sub>IN</sub>	Input Voltage	6.0	V
V <sub>CE</sub>	Input Voltage (CE Pin)	6.0	V
V <sub>OUT</sub>	Output Voltage	-0.3 to V <sub>IN</sub> +0.3	V
I <sub>OUT1</sub>	Output Current 1	400	mA
I <sub>OUT2</sub>	Output Current 2	400	mA
P <sub>D</sub>	Power Dissipation (DFN(PLP)2020-8)*	880	mW
T <sub>opt</sub>	Operating Temperature Range	-40 to 85	°C
T <sub>stg</sub>	Storage Temperature Range	-55 to 125	°C

\*) For Power Dissipation, please refer to PACKAGE INFORMATION.

### ABSOLUTE MAXIMUM RATINGS

Electronic and mechanical stress momentarily exceeded absolute maximum ratings may cause permanent damage and may degrade the life time and safety for both device and system using the device in the field. The functional operation at or over these absolute maximum ratings is not assured.

## ELECTRICAL CHARACTERISTICS

### • RP150KxxxA/B

$V_{IN} = \text{Set } V_{OUT} + 1V$  for higher output of the regulator pair,  $I_{OUT} = 1mA$ ,  $C_{IN} = C_{OUT} = 1\mu F$ , unless otherwise noted.

VR1/VR2

$T_{opt} = 25^{\circ}C$

Symbol	Item	Conditions	Min.	Typ.	Max.	Unit	
$V_{OUT}$	Output Voltage	$V_{IN} = \text{Set } V_{OUT} + 1V$ $I_{OUT} = 1mA$	$V_{OUT} > 2.0V$	$\times 0.99$		$\times 1.01$	V
			$V_{OUT} \leq 2.0V$	-20		+20	mV
$I_{OUT}$	Output Current		300			mA	
$\Delta V_{OUT}/\Delta I_{OUT}$	Load Regulation	$1mA \leq I_{OUT} \leq 200mA$		20	40	mV	
$V_{DIF}$	Dropout Voltage	$I_{OUT} = 300mA$	$1.5V \leq \text{Set } V_{OUT} < 1.7V$		0.40	1.00	V
			$1.7V \leq \text{Set } V_{OUT} < 2.0V$		0.34	0.80	
			$2.0V \leq \text{Set } V_{OUT} < 2.5V$		0.29	0.50	
			$2.5V \leq \text{Set } V_{OUT} < 2.8V$		0.24	0.38	
			$2.8V \leq \text{Set } V_{OUT} \leq 3.3V$		0.21	0.34	
$I_{SS}$	Supply Current	$I_{OUT} = 0mA$		24	33	$\mu A$	
$I_{standby}$	Standby Current	$V_{CE} = 0V$		0.1	3.0	$\mu A$	
$\frac{\Delta V_{OUT}}{\Delta V_{IN}}$	Line Regulation	Set $V_{OUT} + 0.5V \leq V_{IN} \leq 5.0V$ (In case that $V_{OUT} \leq 2.0V$ , $2.5V \leq V_{IN} \leq 5.0V$ )		0.02	0.10	%/V	
RR	Ripple Rejection	$f = 1kHz$ , Ripple 0.2Vp-p $V_{IN} = \text{Set } V_{OUT} + 1V$ , $I_{OUT} = 30mA$ (In case that $V_{OUT} \leq 2.0V$ , $V_{IN} = 3V$ )		80		dB	
$V_{IN}$	Input Voltage*		2.5		5.25	V	
$\Delta V_{OUT}/\Delta T_{opt}$	Output Voltage Temperature Coefficient	$-40^{\circ}C \leq T_{opt} \leq 85^{\circ}C$		$\pm 30$		ppm/ $^{\circ}C$	
$I_{SC}$	Short Current Limit	$V_{OUT} = 0V$		50		mA	
$I_{PD}$	CE Pull-down Current		0.05	0.3	0.6	$\mu A$	
$V_{CEH}$	CE Input Voltage "H"		1.5		6.0	V	
$V_{CEL}$	CE Input Voltage "L"				0.3	V	
en	Output Noise	$BW = 10Hz$ to $100kHz$		30		$\mu V_{rms}$	
$R_{LOW}$	Low Output Nch Tr. ON Resistance (of B version)	$V_{IN} = 4.0V$ $V_{CE} = 0V$		30		$\Omega$	

\*) The maximum Input Voltage of the ELECTRICAL CHARACTERISTICS is 5.25V. In case of exceeding this specification, the IC must be operated on condition that the Input Voltage is up to 5.5V and the total operating time is within 500hrs.

#### RECOMMENDED OPERATING CONDITIONS (ELECTRICAL CHARACTERISTICS)

All of electronic equipment should be designed that the mounted semiconductor devices operate within the recommended operating conditions. The semiconductor devices cannot operate normally over the recommended operating conditions, even if they are used over such conditions by momentary electronic noise or surge. And the semiconductor devices may receive serious damage when they continue to operate over the recommended operating conditions.

## TECHNICAL NOTES

When using these ICs, consider the following points:

### PCB Layout

Make  $V_{DD}$  and GND lines sufficient. If their impedance is high, noise pickup or unstable operation may result.

Connect a capacitor with a capacitance value as much as  $1.0\mu\text{F}$  or more as C1 between  $V_{DD}$  and GND pin, and as close as possible to the pins.

Set the output capacitors C2 and C3 for phase compensation, as close as possible to the ICs, and make wiring as short as possible.

### Phase Compensation

In these ICs, phase compensation is made for securing stable operation even if the load current is varied.

For this purpose, connect capacitors with a capacitance value as much as  $1.0\mu\text{F}$  or more as C2 and C3 with good frequency characteristics and ESR (Equivalent Series Resistance) between  $V_{OUT}$  and GND pin, and as close as possible to the pins.

If you use a tantalum type capacitor and ESR value of the capacitor is large, output might be unstable. Evaluate your circuit with considering frequency characteristics.

Depending on the capacitor size, manufacturer, and part number, the bias characteristics and temperature characteristics are different. Evaluate the circuit with actual using capacitors.

## TYPICAL APPLICATIONS

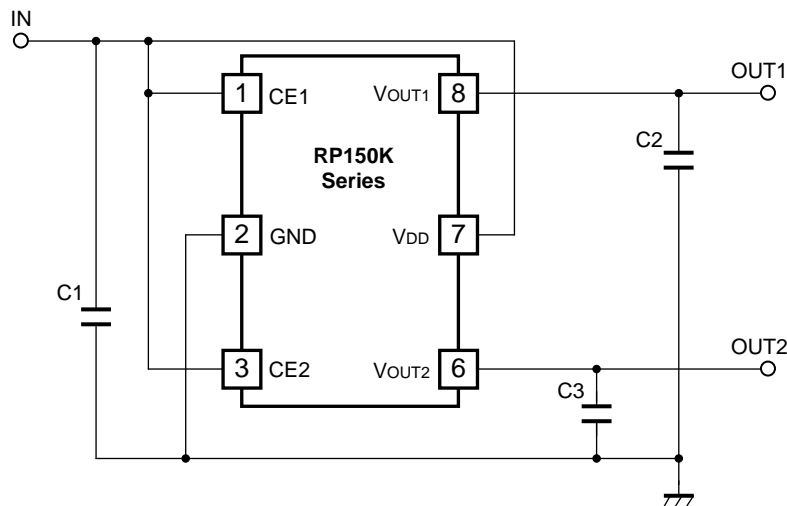

(External Components)

Output Capacitor ; Ceramic Type

1.0 $\mu\text{F}$	Kyocera	CM05X5R105K06AB
	TDK	C1005JB0J105K
	Murata	GRM155B31A105KE15

TEST CIRCUITS

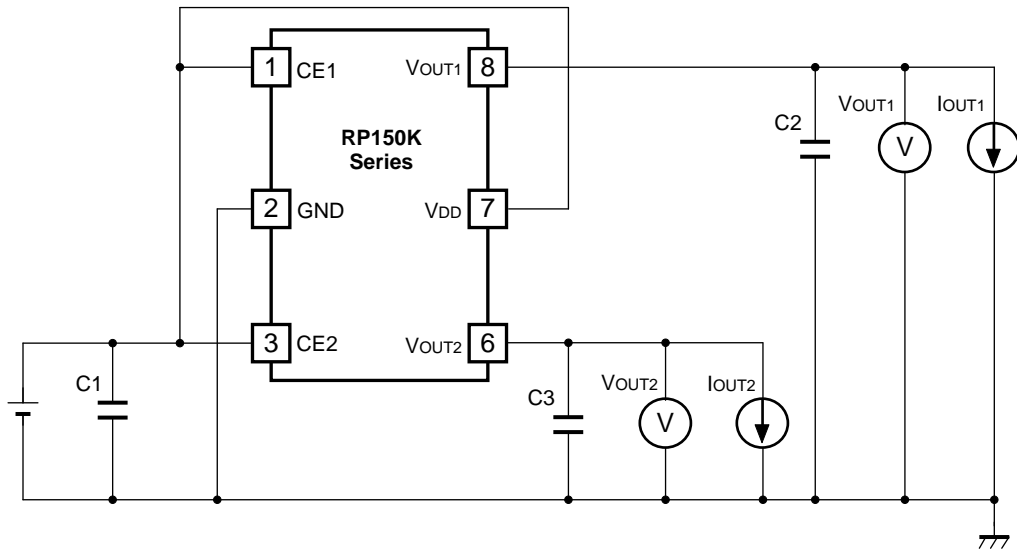

Standard test Circuit

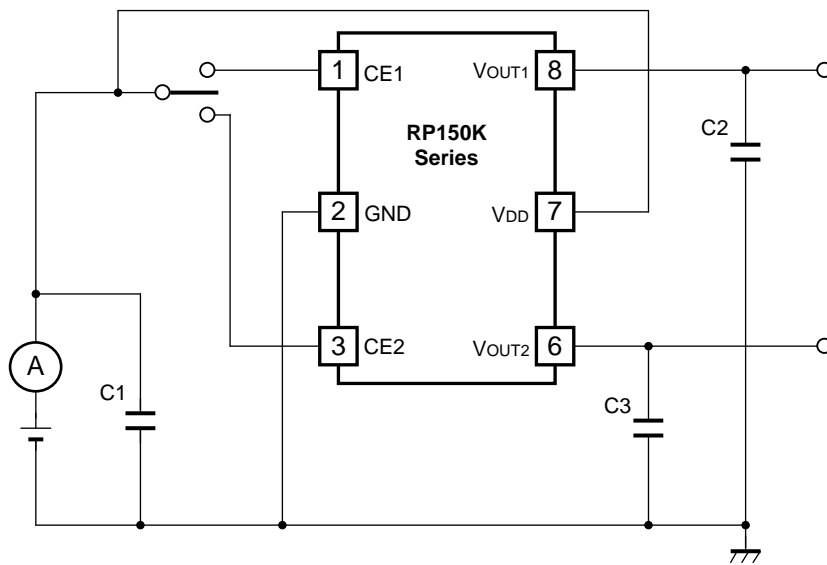

Supply Current Test Circuit

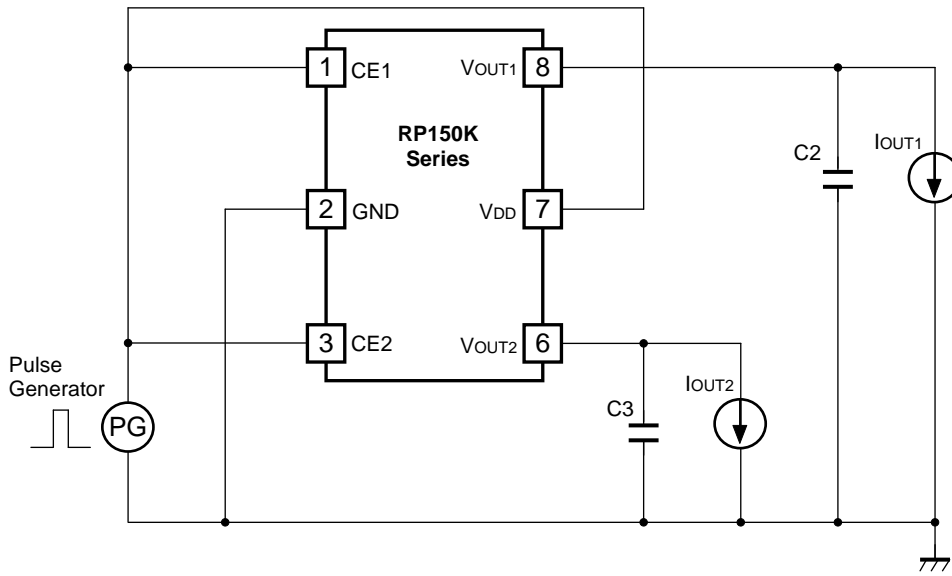

Ripple Rejection Test Circuit

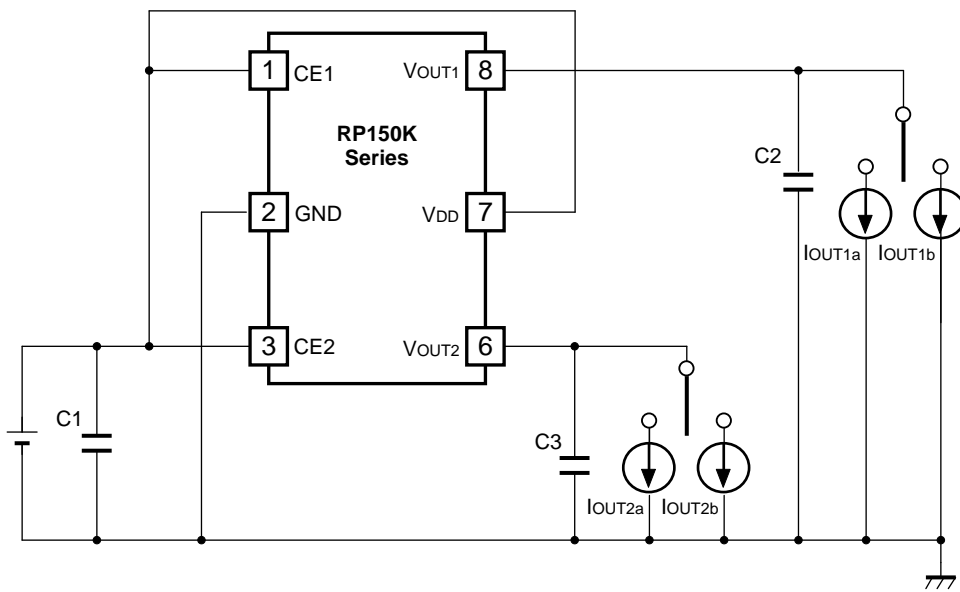

Load Transient Response Test Circuit



## TYPICAL CHARACTERISTICS

### 1) Output Voltage vs. Output Current ( $T_{opt}=25^{\circ}C$ )

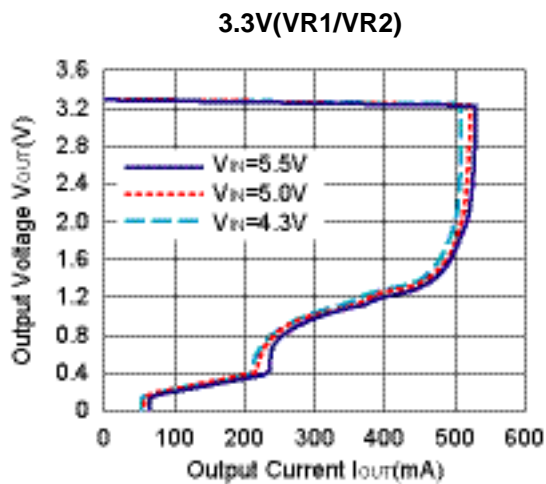
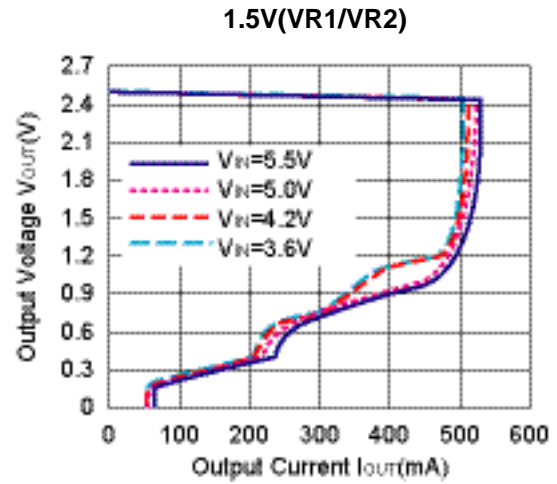
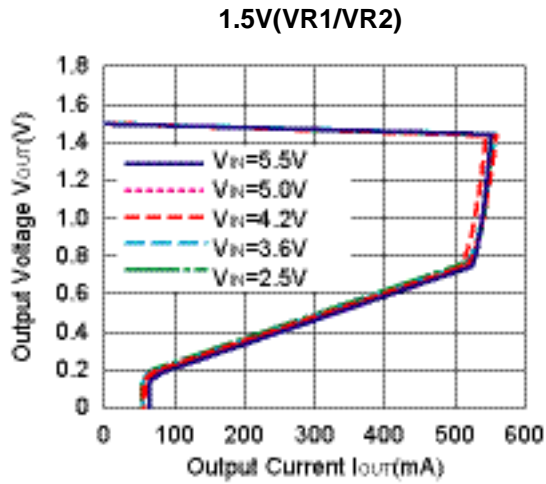

### 2) Output Voltage vs. Input Voltage ( $T_{opt}=25^{\circ}C$ )

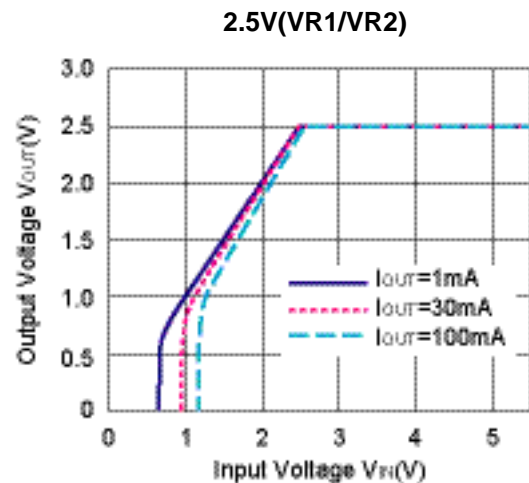
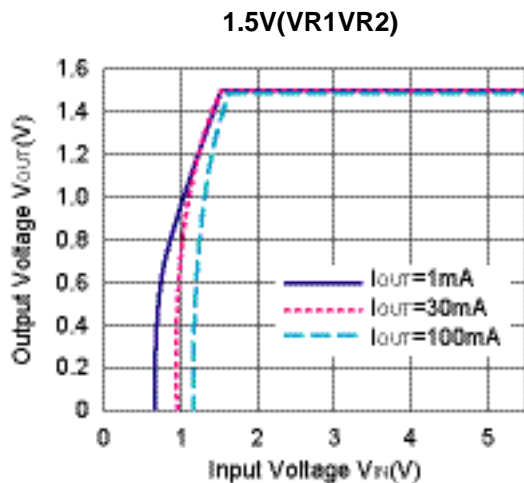

3.3V(VR1/VR2)

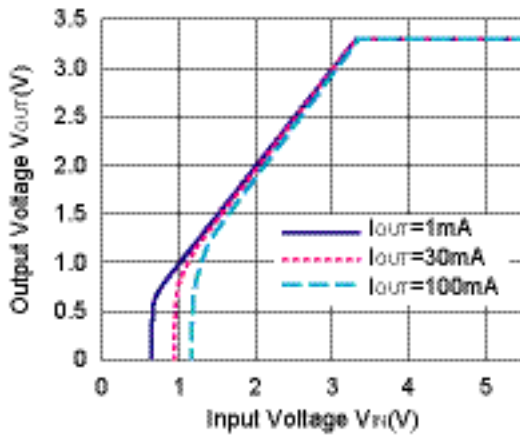

3) Supply Current vs. Input Voltage ( $T_{opt} = 25^\circ\text{C}$ )

1.5V(VR1/VR2)

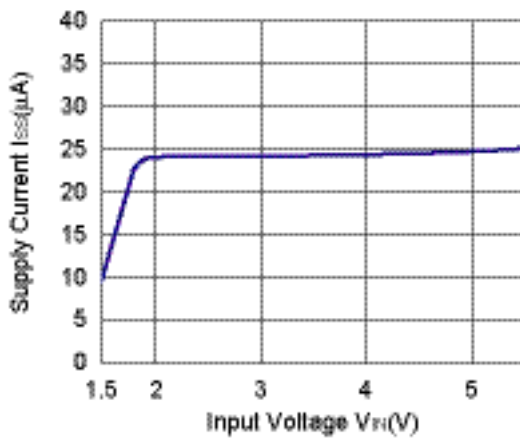

2.5V(VR1/VR2)

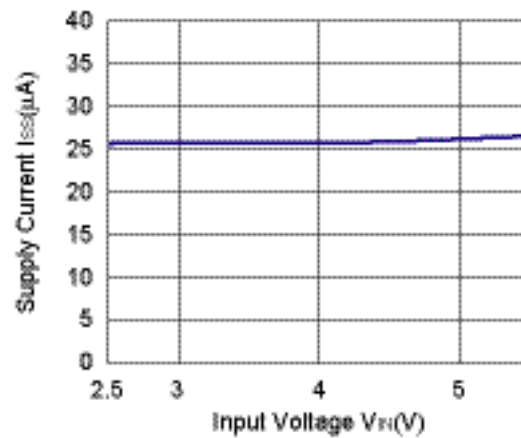

3.3V(VR1/VR2)

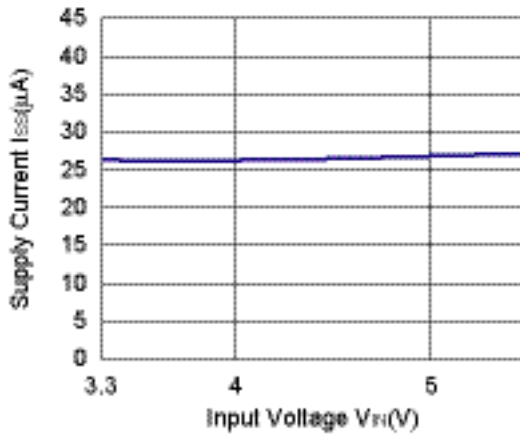

4) Output Voltage vs. Temperature

1.5V(VR1/VR2)

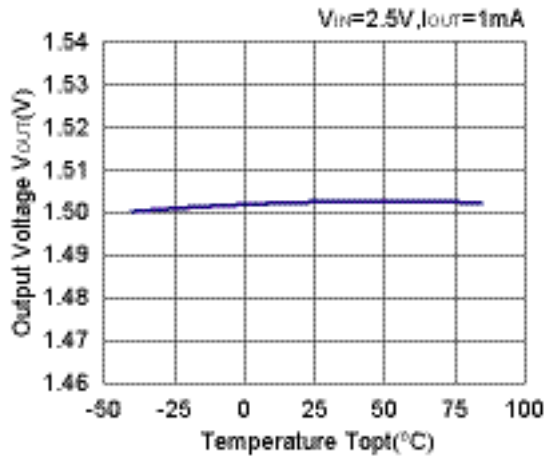

2.5V(VR1/VR2)

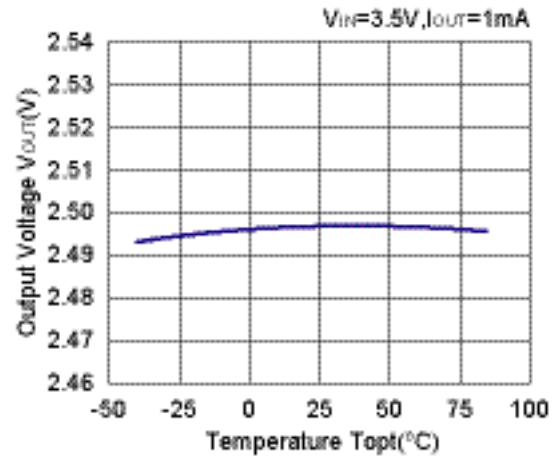

3.3V(VR1/VR2)

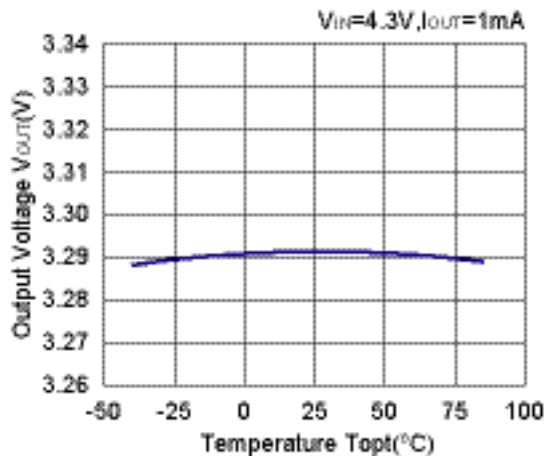

5) Supply Current vs. Temperature

1.5V(VR1/VR2)

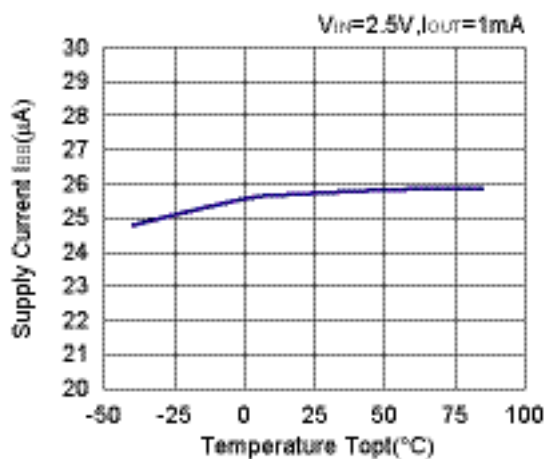

2.5V(VR1/VR2)

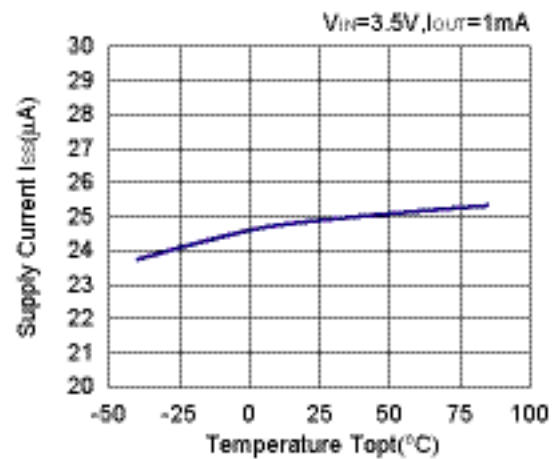

3.3V(VR1/VR2)

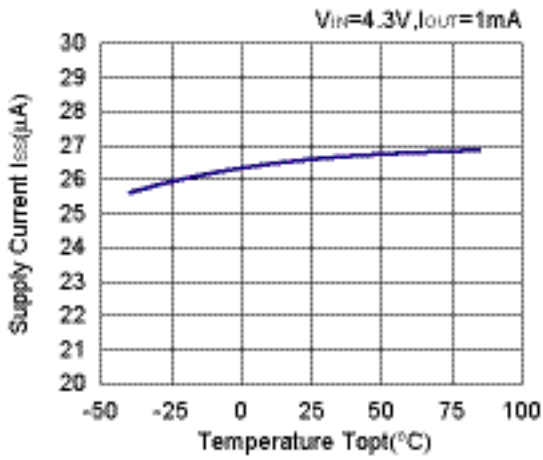

6) Dropout Voltage vs. Output Current

1.5V(VR1/VR2)

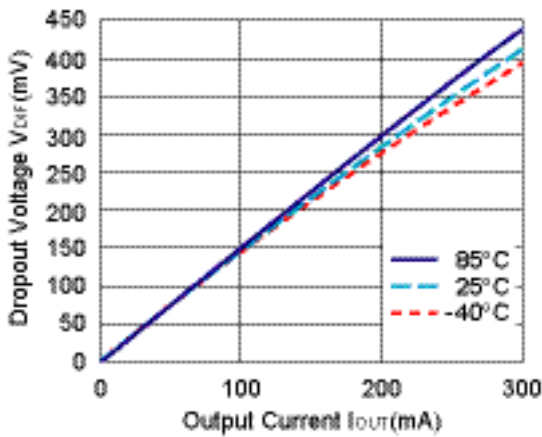

2.5V(VR1/VR2)

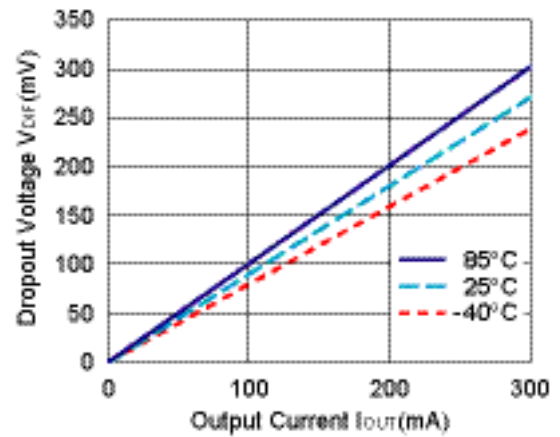

3.3V(VR1/VR2)

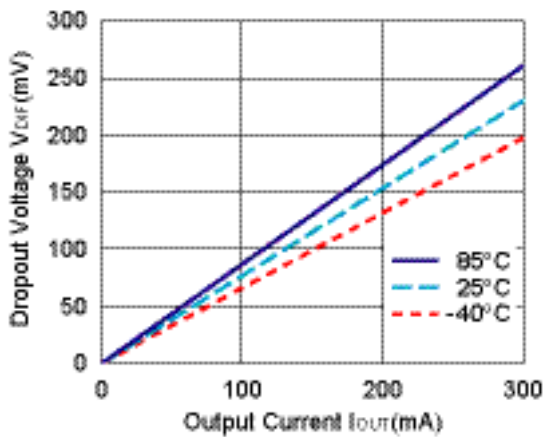

7) Dropout Voltage vs. VR\_VSET

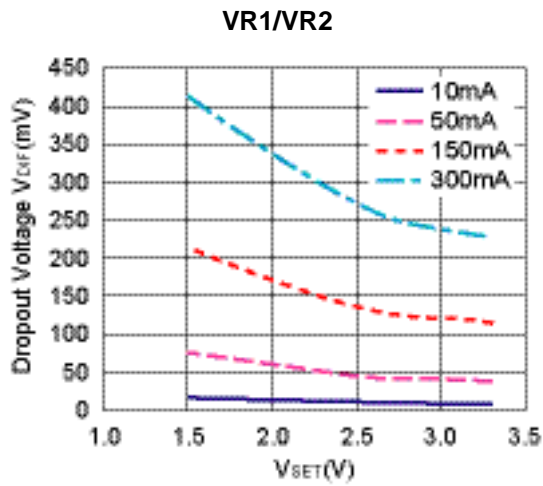

8) Ripple Rejection vs. Input Bias (Input Ripple=0.5Vp-p, T<sub>opt</sub>=25°C)

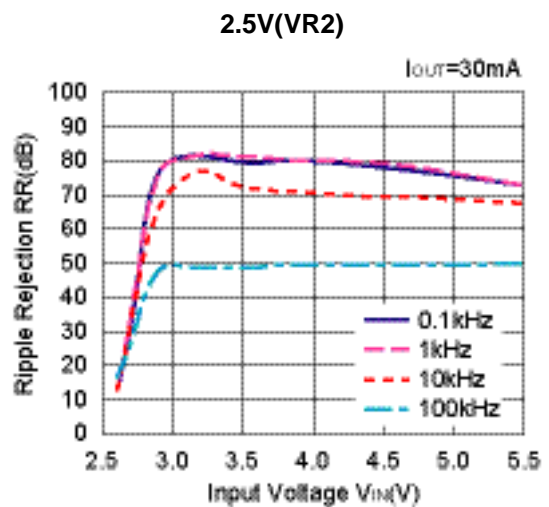
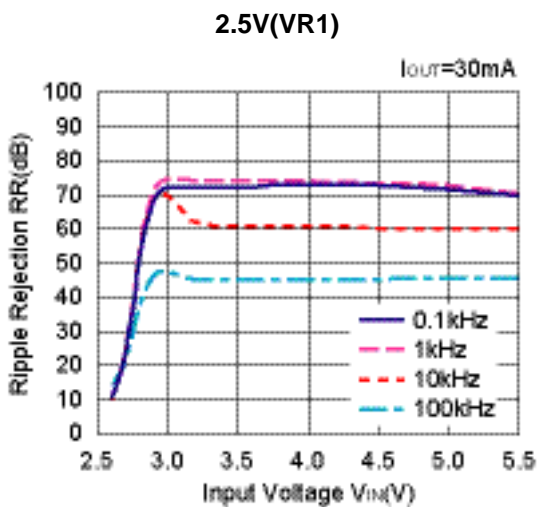
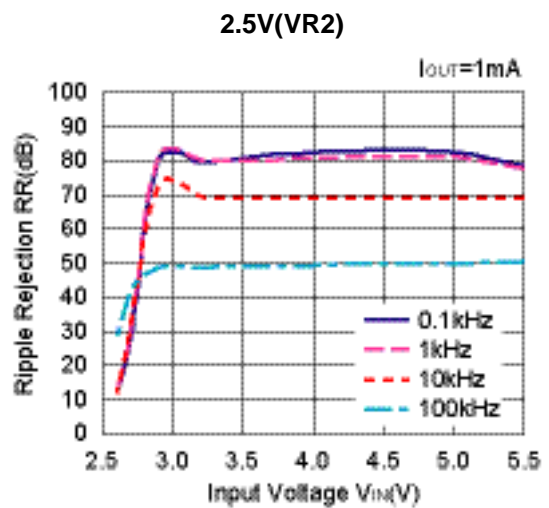
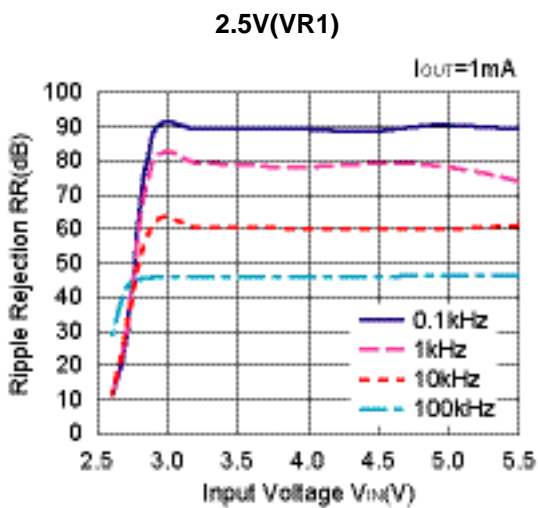

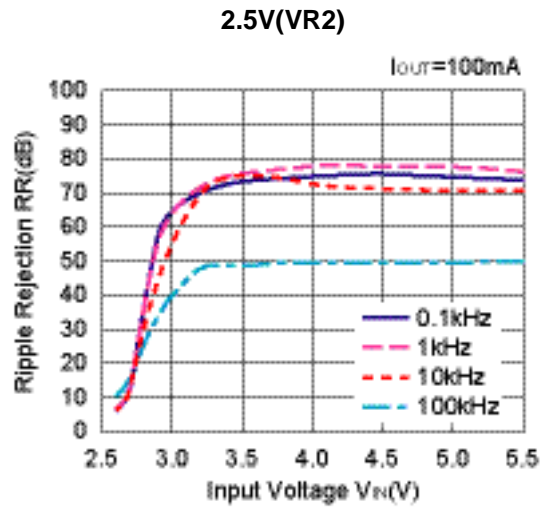
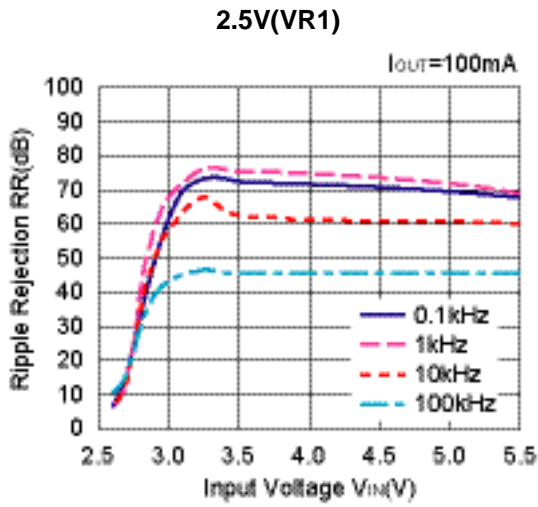

9) Ripple Rejection vs. Frequency (Ripple=0.5Vp-p)

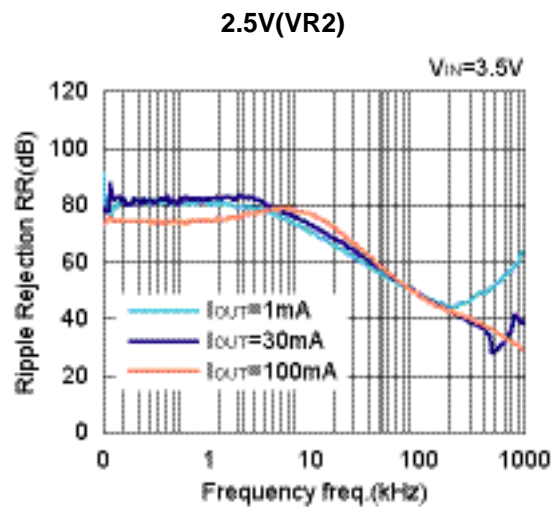
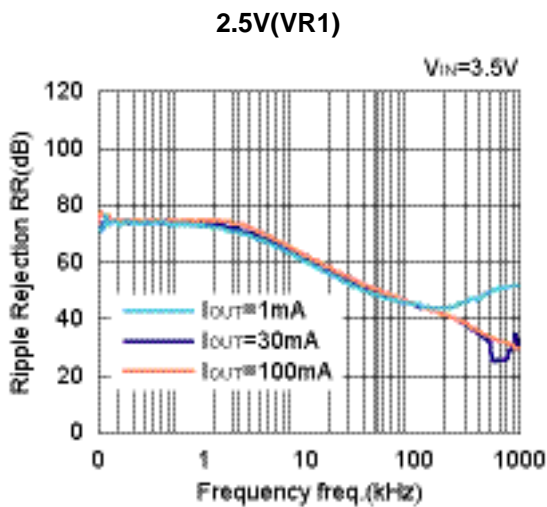
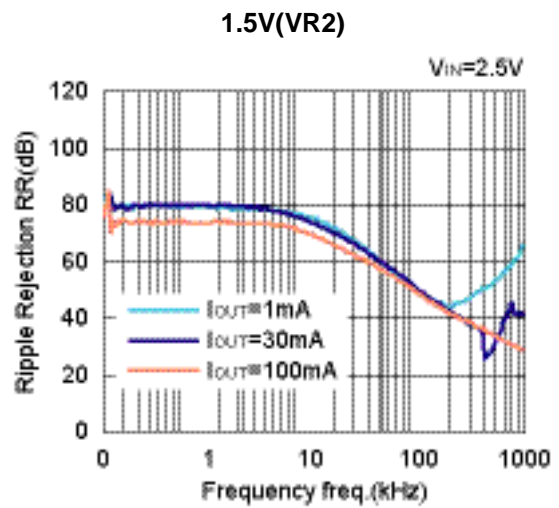
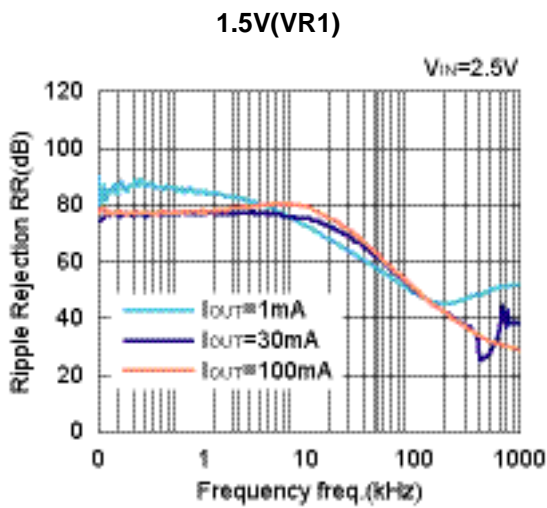

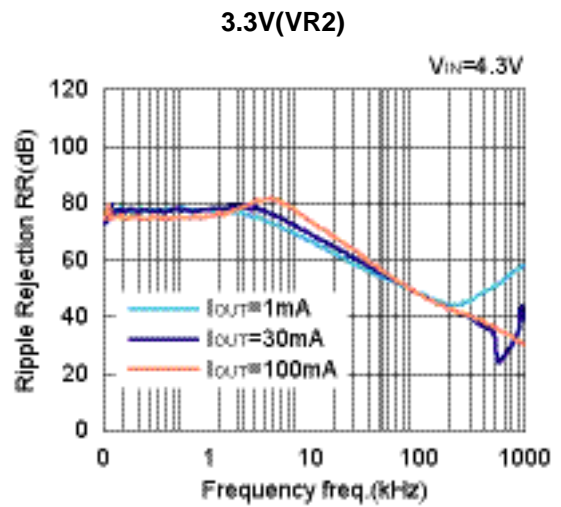
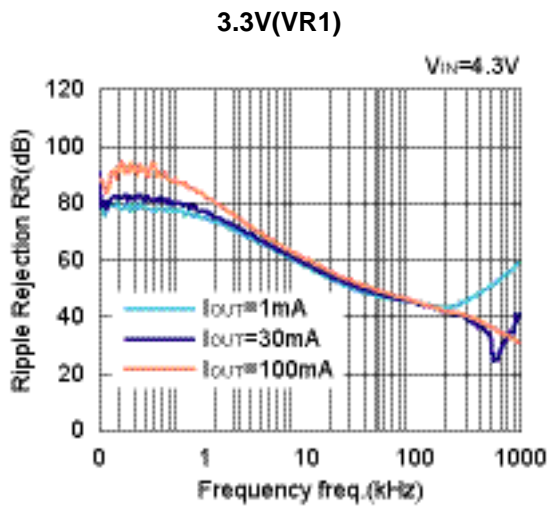

**10) Input Transient Response ( $t_r=t_f=5\mu s$ ,  $T_{opt}=25^\circ C$ )**

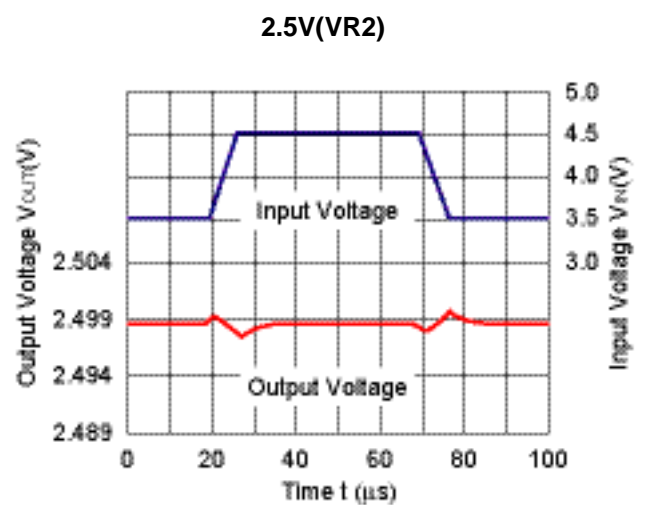
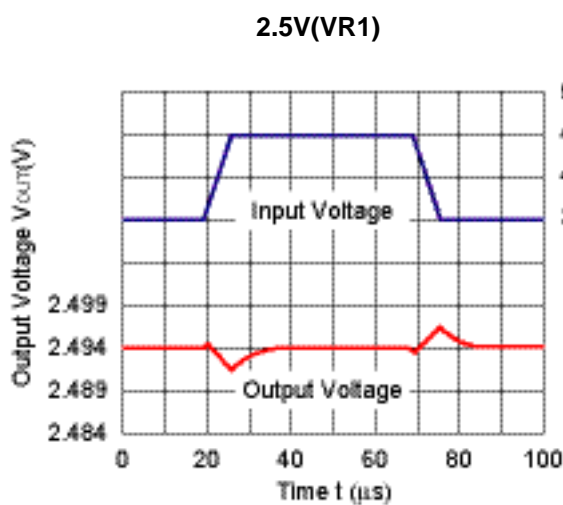
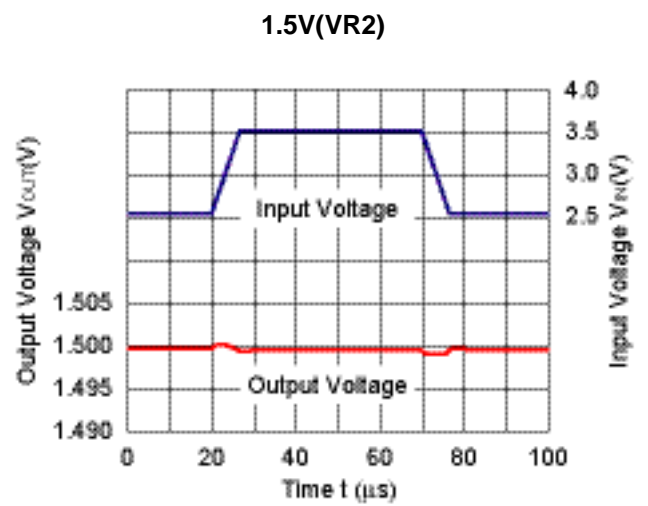
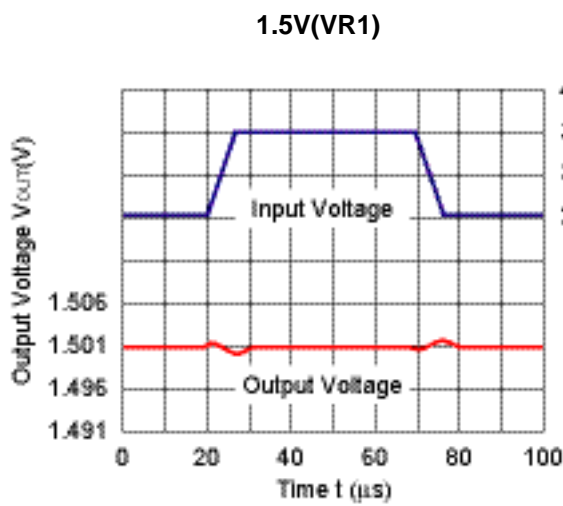

3.3V(VR1)

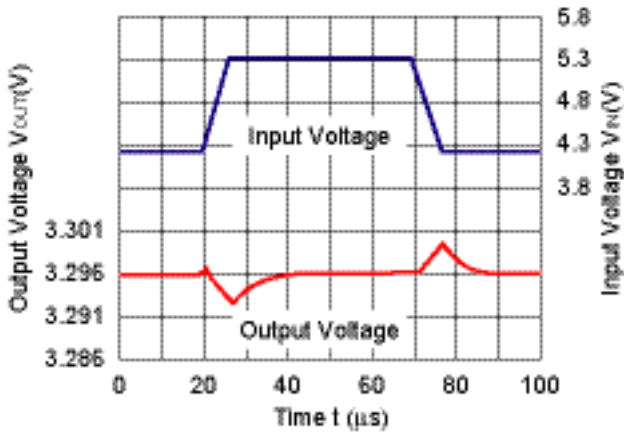

3.3V(VR2)

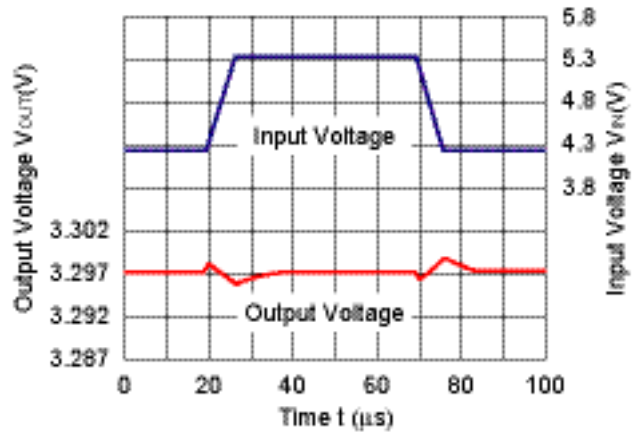

11) Load Transient Response ( $t_r=t_f=500\text{ns}$ ,  $T_{opt}=25^\circ\text{C}$ )

1.5V(VR1)

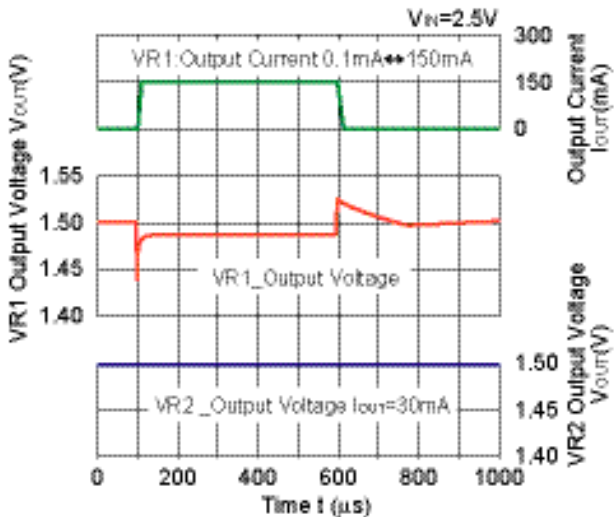

1.5V(VR2)

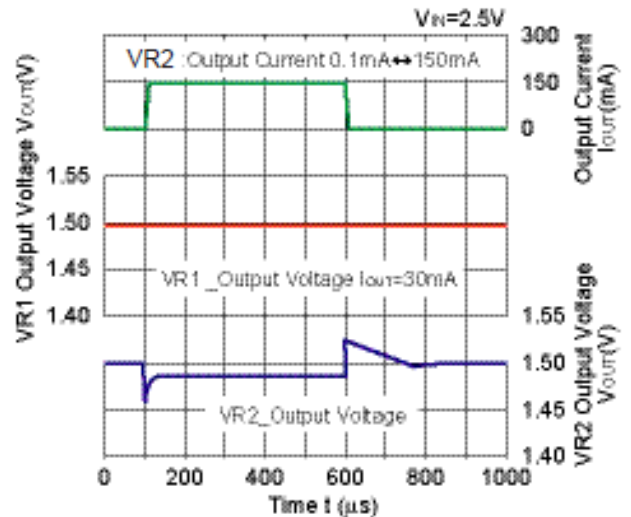

1.5V(VR1)

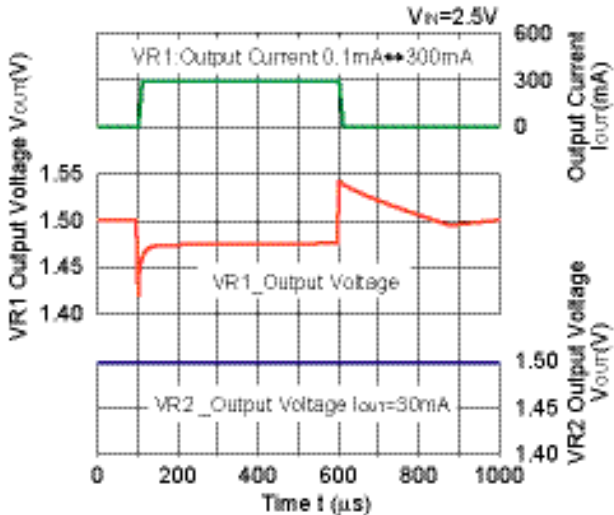

1.5V(VR2)

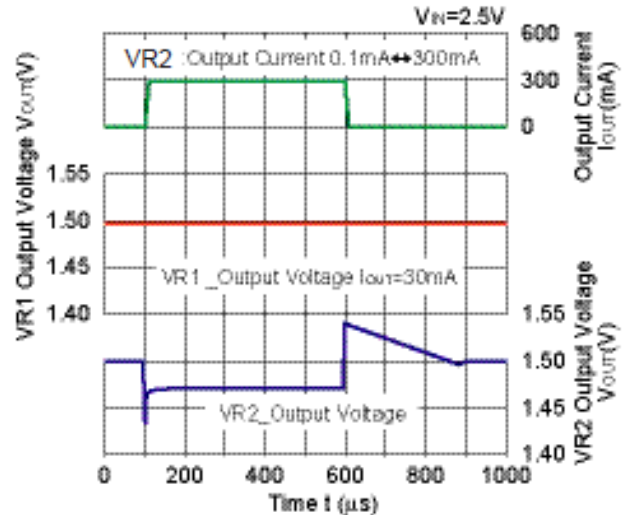



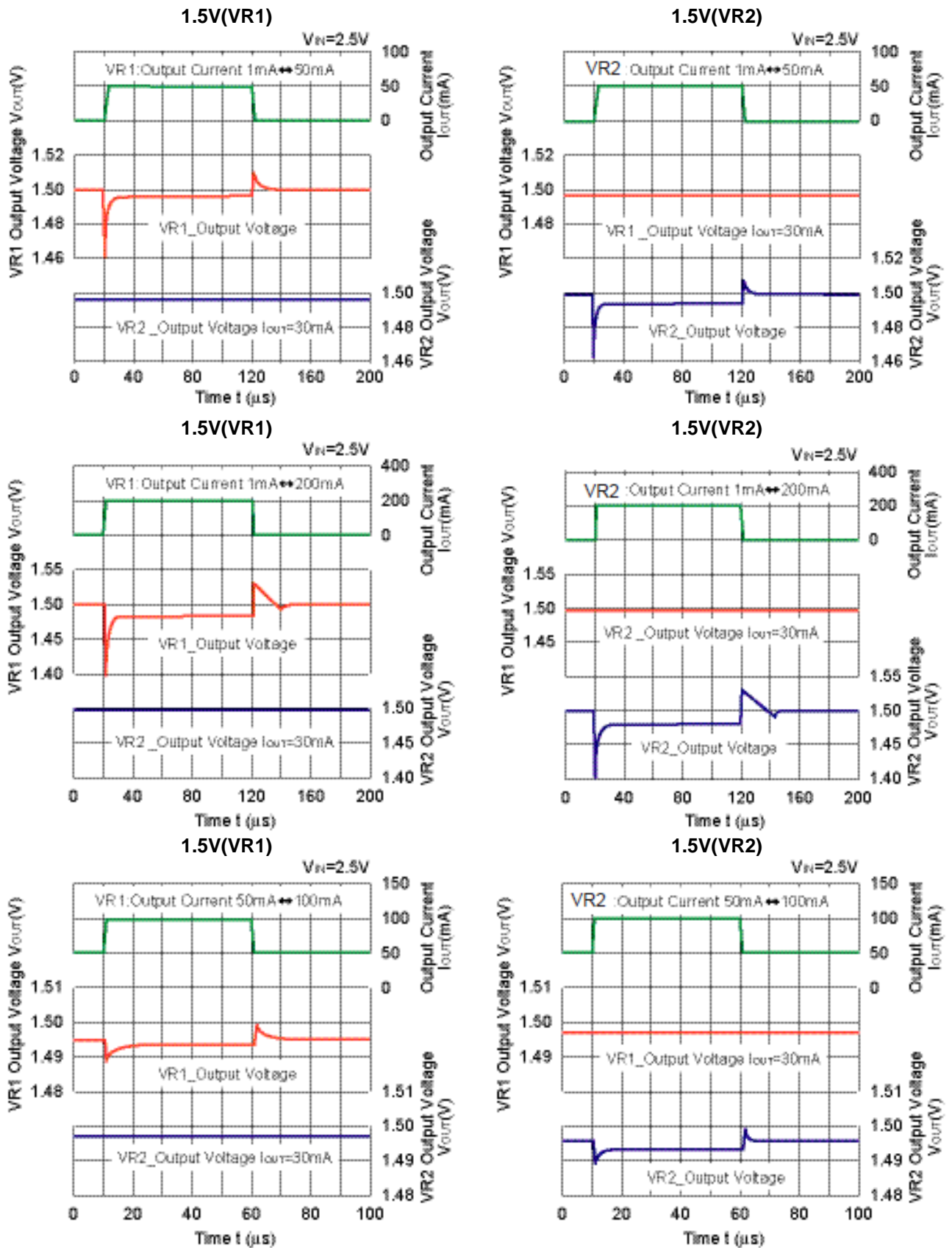

2.5V(VR1)

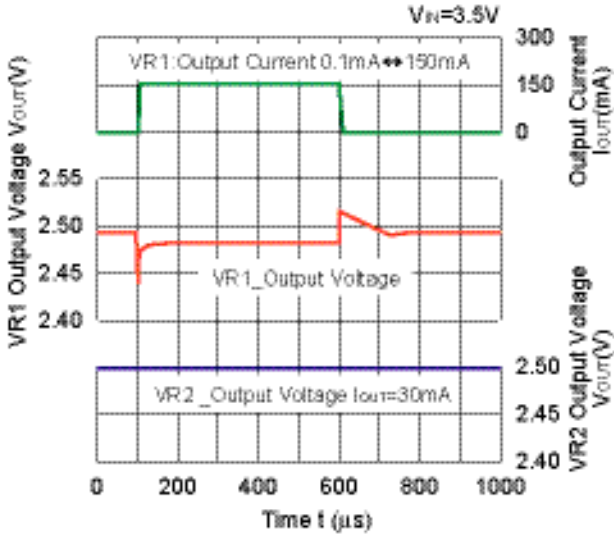

2.5V(VR2)

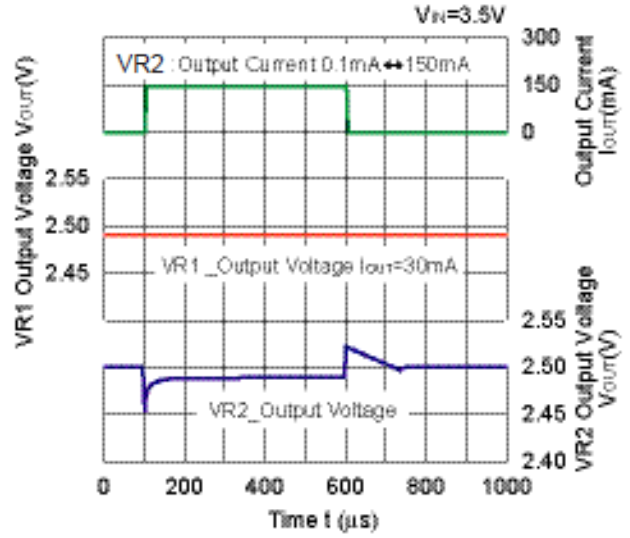

2.5V(VR1)

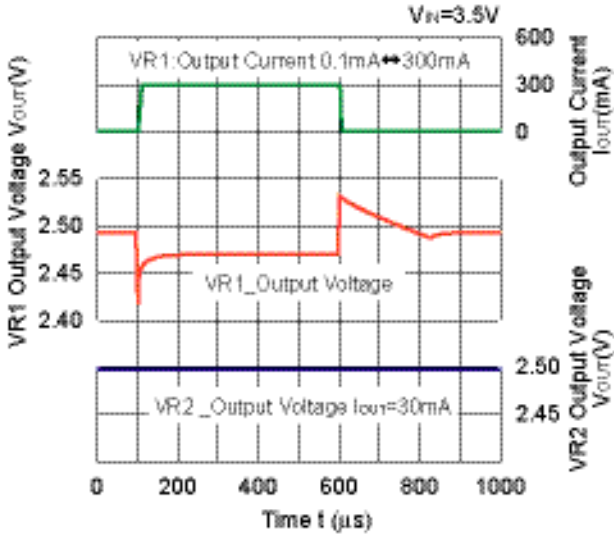

2.5V(VR2)

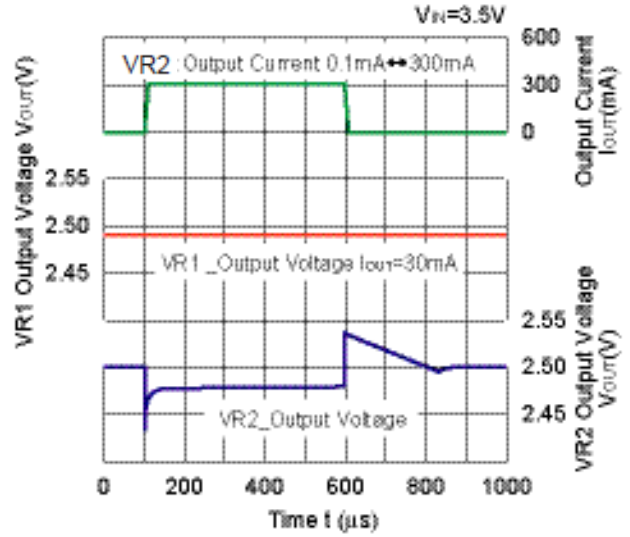

2.5V(VR1)

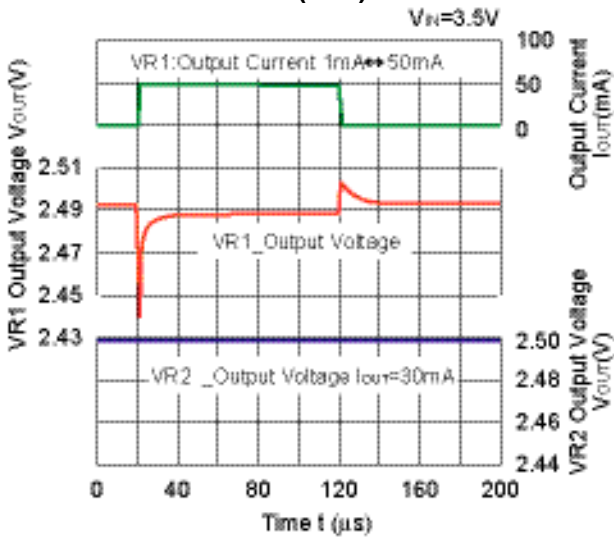

2.5V(VR2)

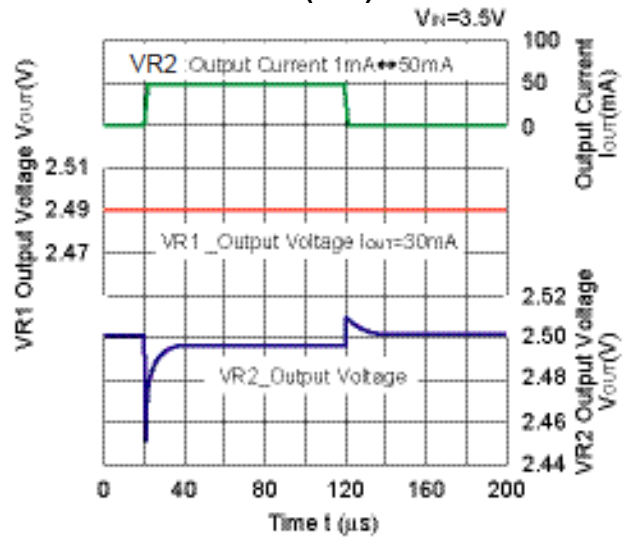

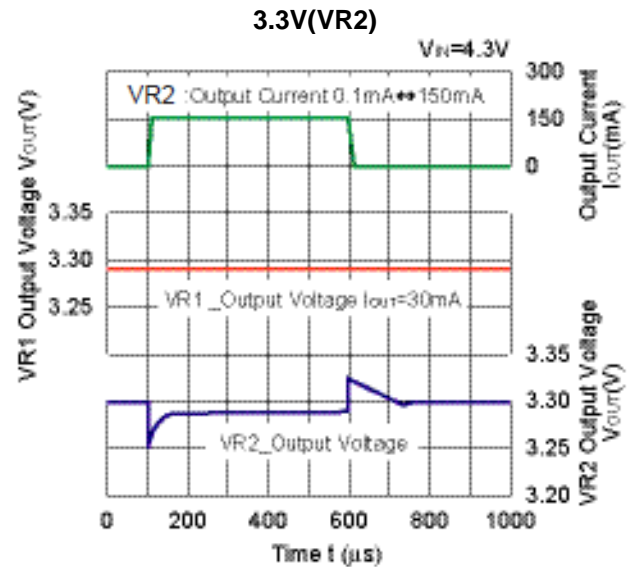
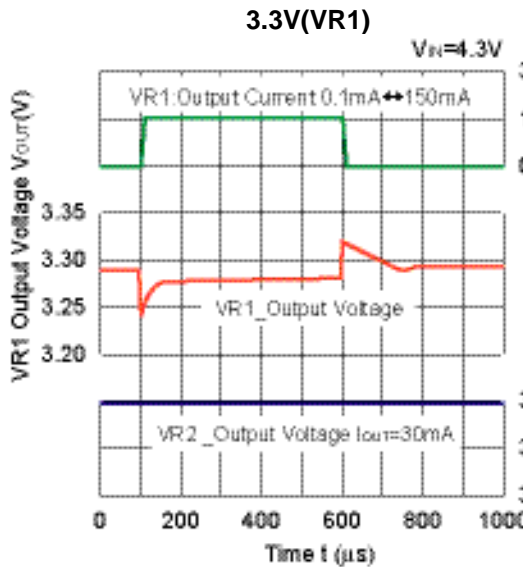
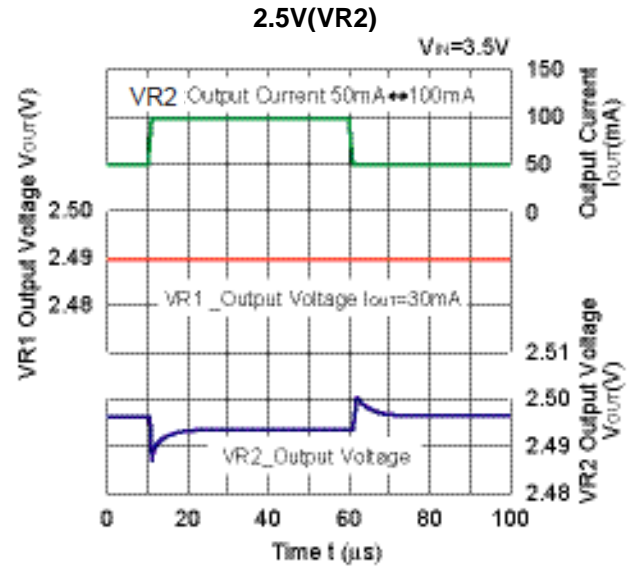
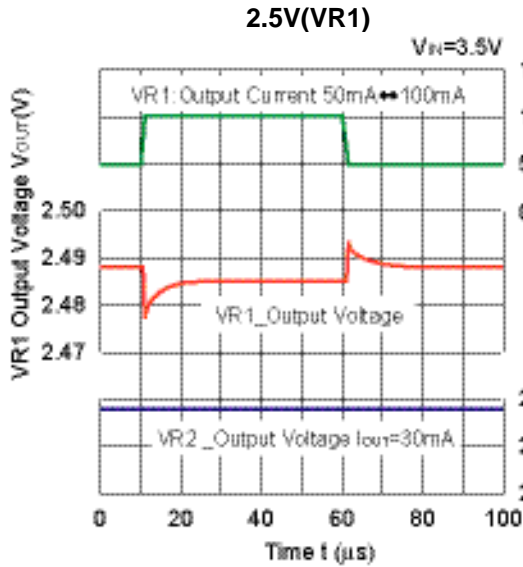
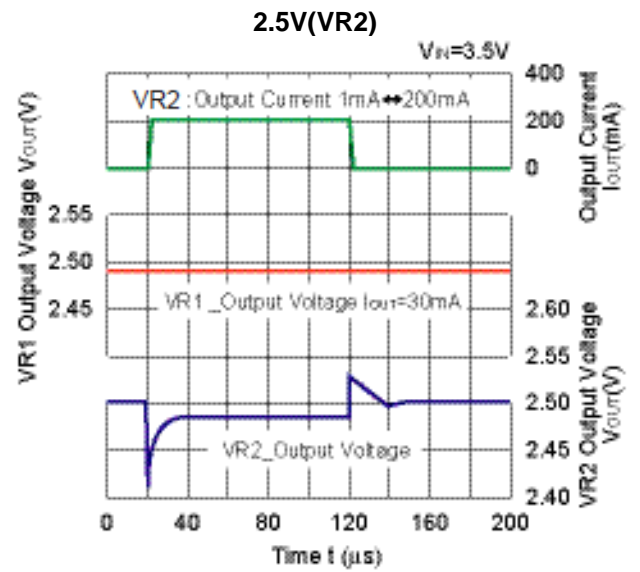
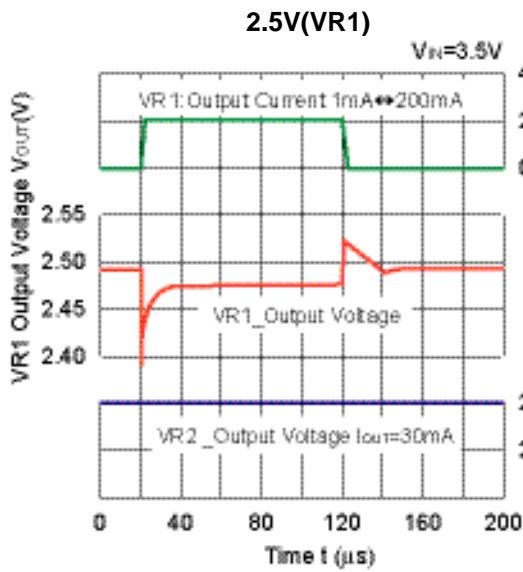

3.3V(VR1)

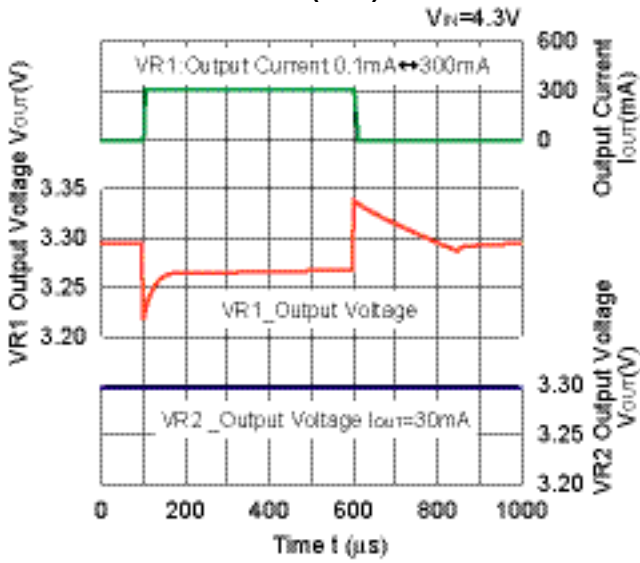

3.3V(VR2)

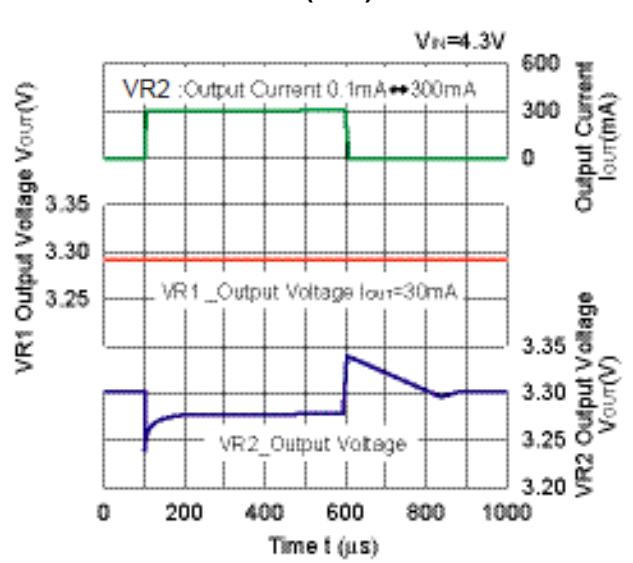

3.3V(VR1)

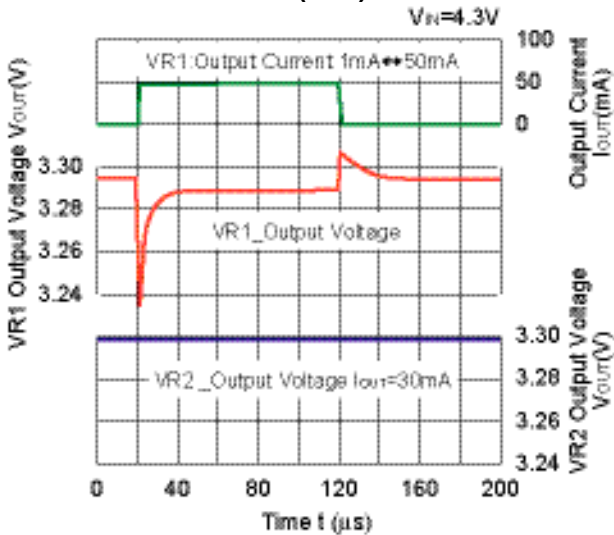

3.3V(VR2)

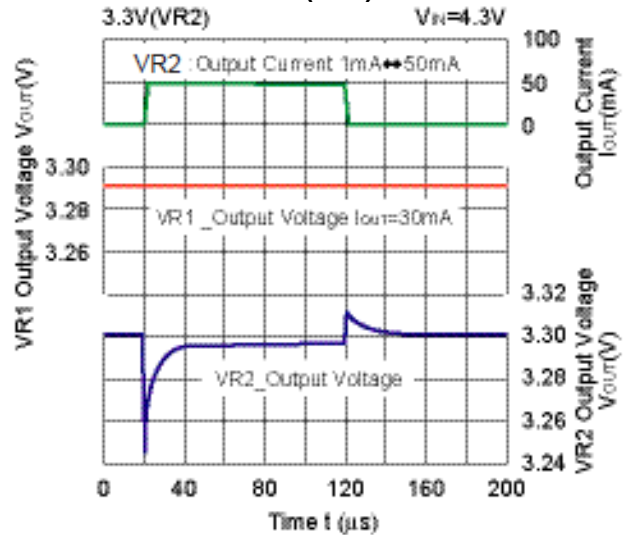

3.3V(VR1)

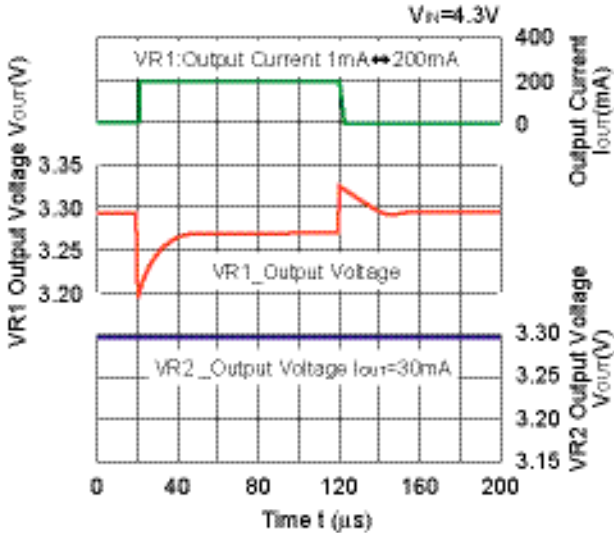

3.3V(VR2)

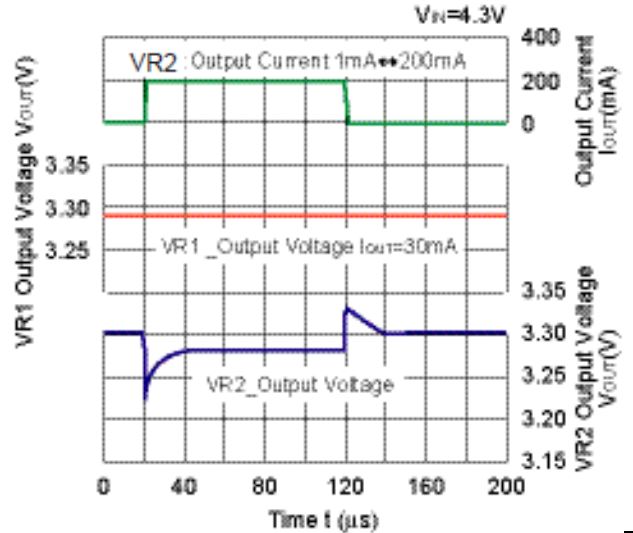

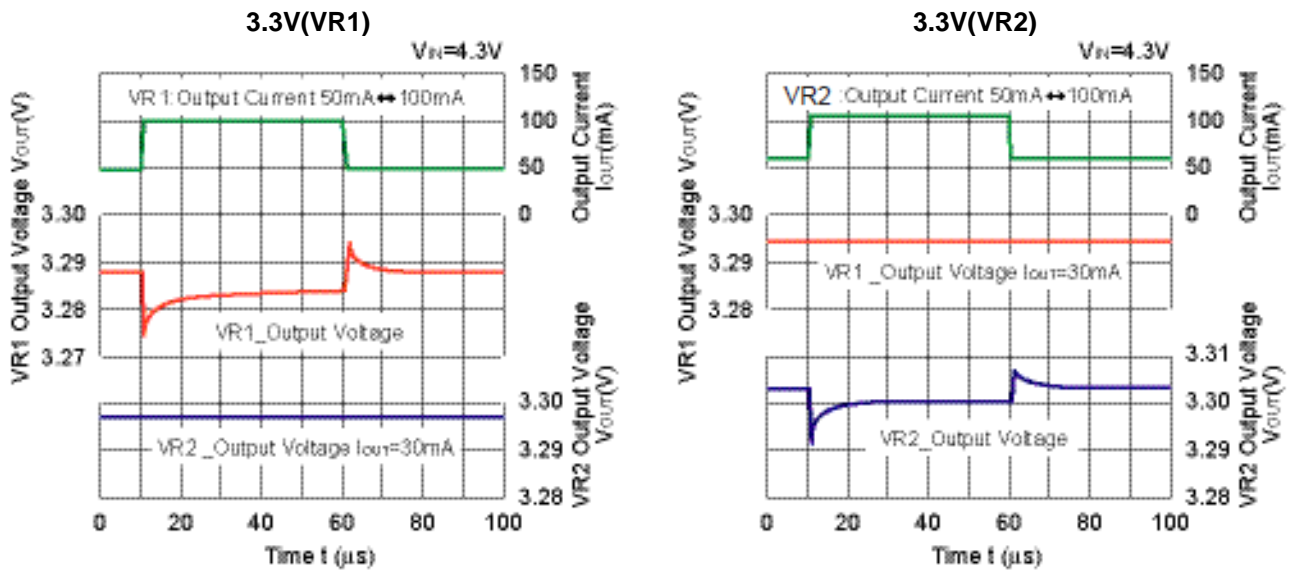

12) Turn On Speed with CE pin ( $T_{opt}=25^{\circ}C$ )

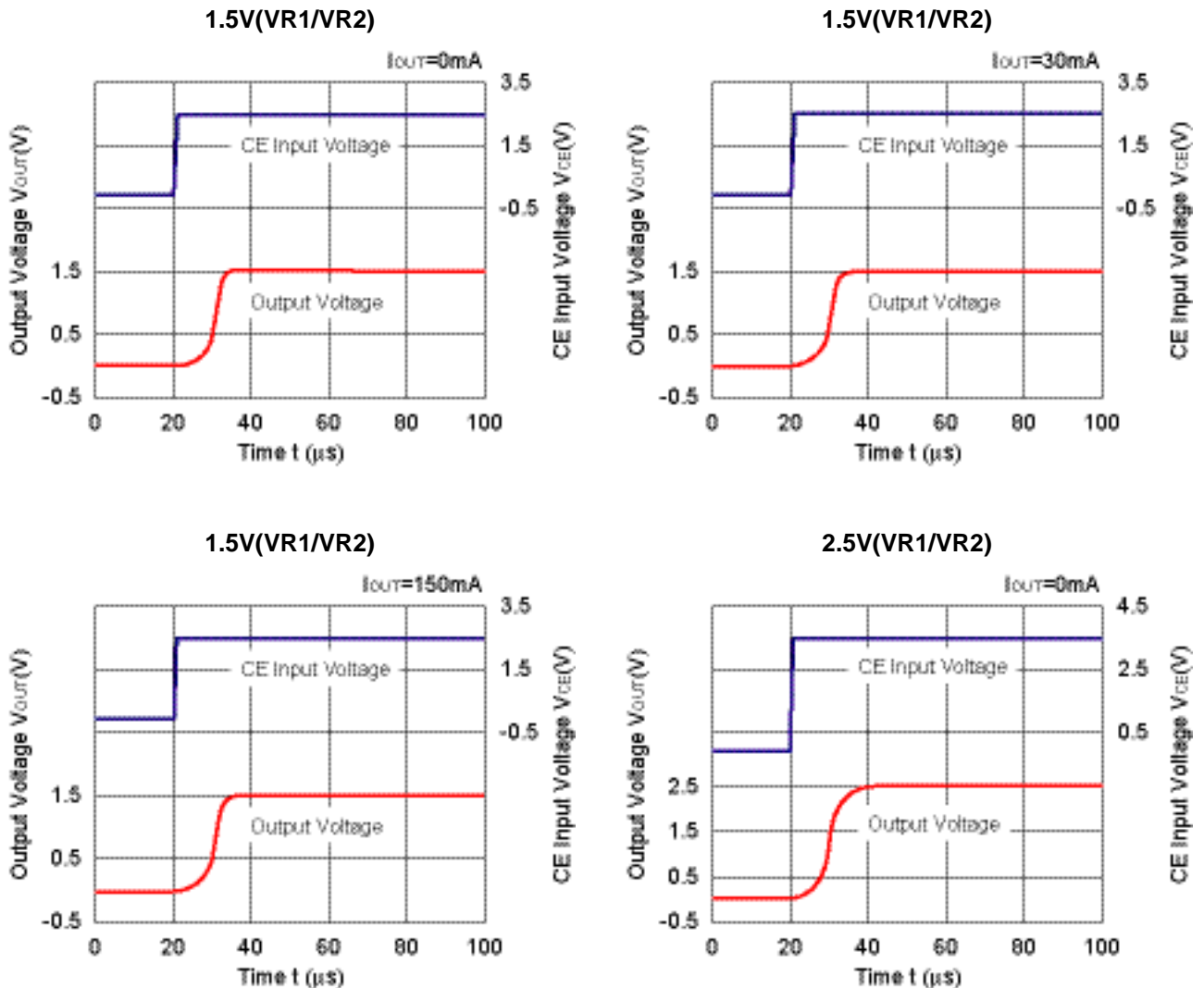

2.5V(VR1/VR2)

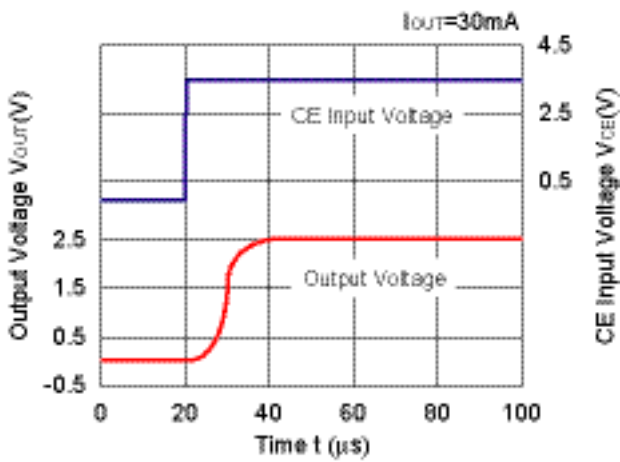

2.5V(VR1/VR2)

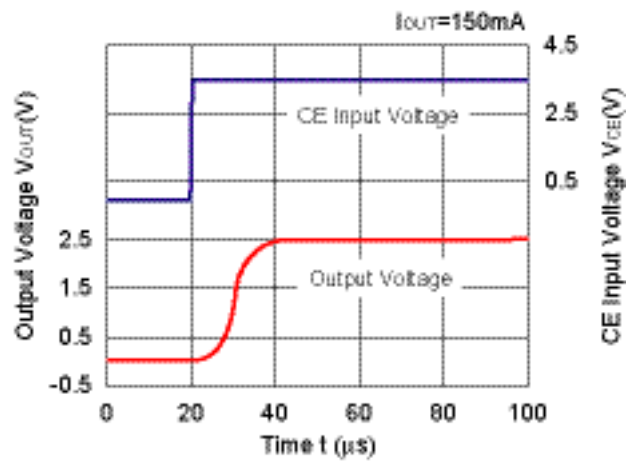

3.3V(VR1/VR2)

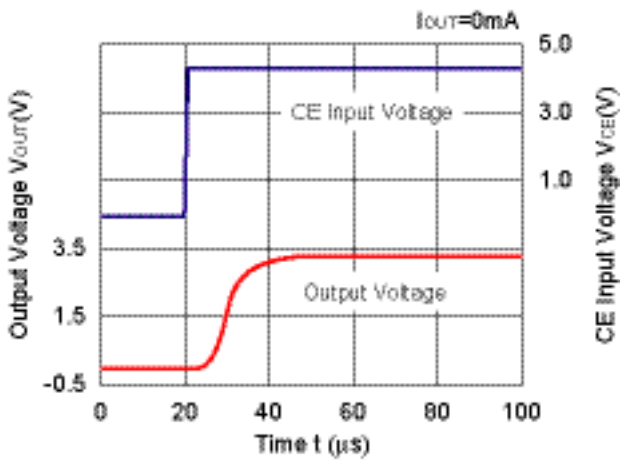

3.3V(VR1/VR2)

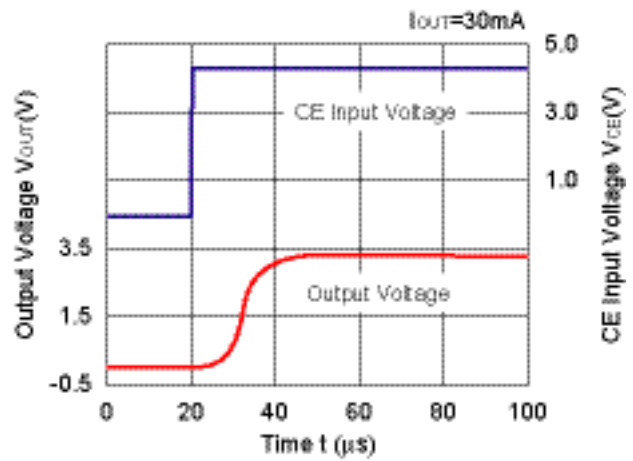

3.3V(VR1/VR2)

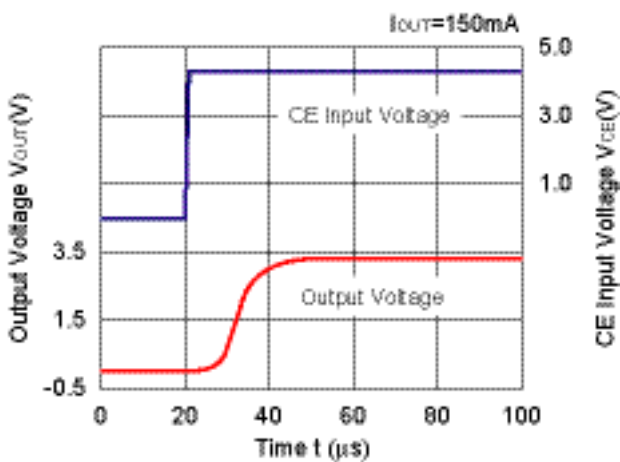

13) Turn Off Speed with CE pin ( $T_{opt}=25^{\circ}C$ )

1.5V(VR1/VR2)

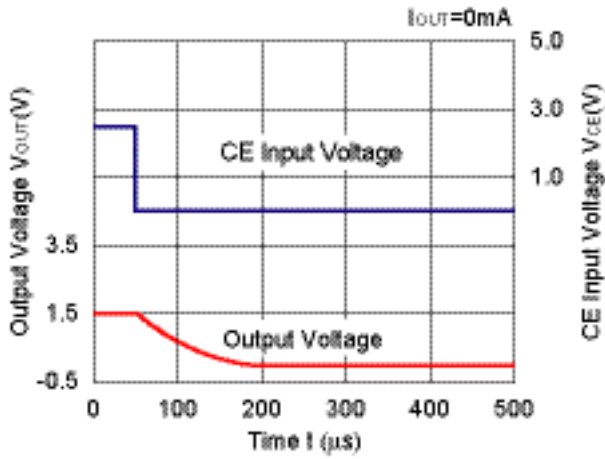

1.5V(VR1/VR2)

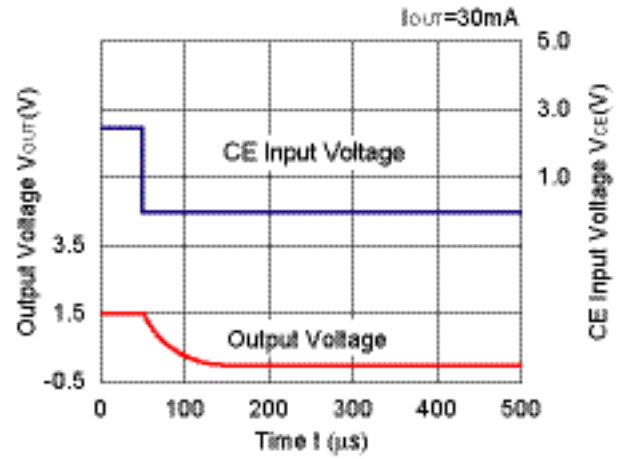

1.5V(VR1/VR2)

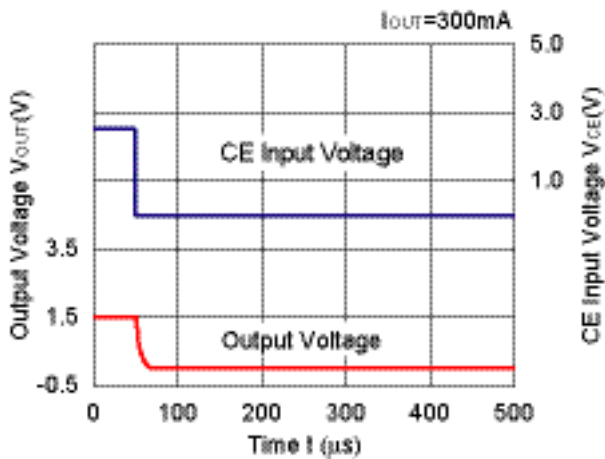

2.5V(VR1/VR2)

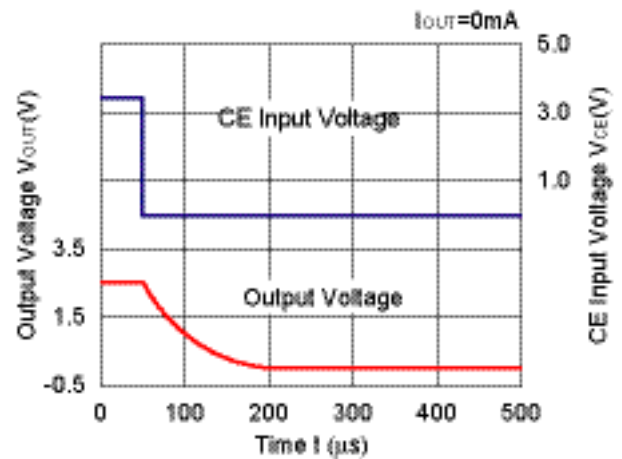

2.5V(VR1/VR2)

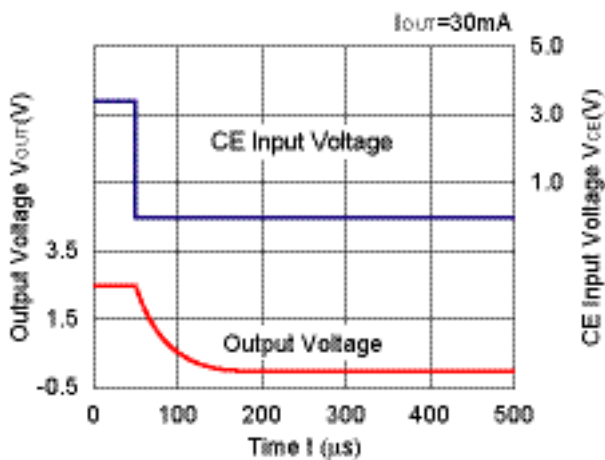

2.5V(VR1/VR2)

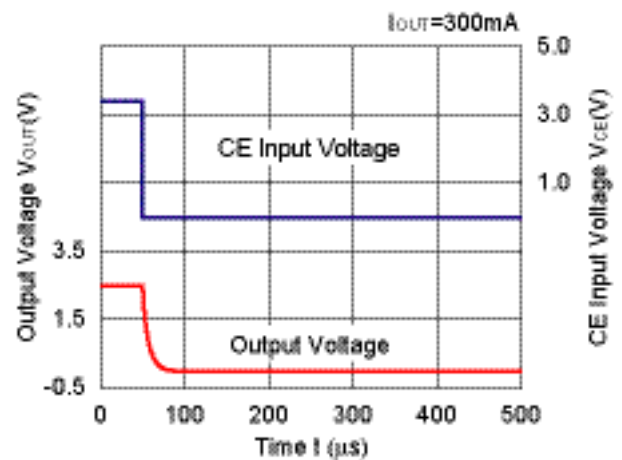

3.3V(VR1/VR2)

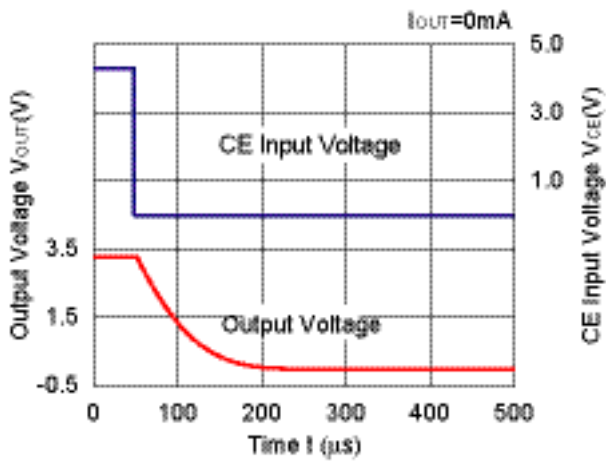

3.3V(VR1/VR2)

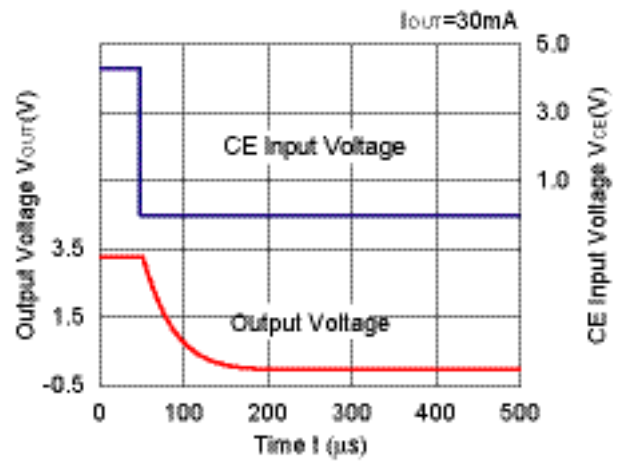

3.3V(VR1/VR2)

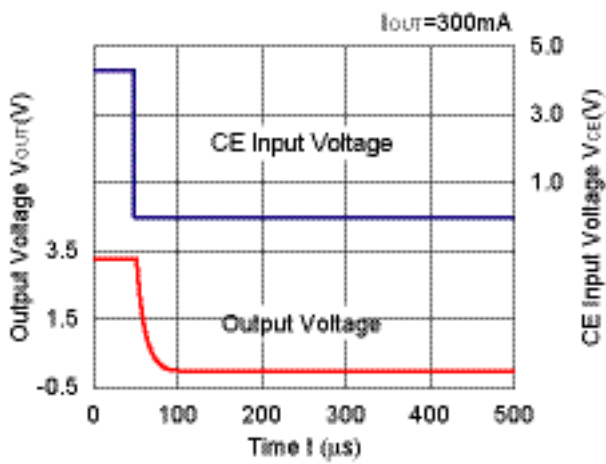



## ESR vs. Output Current

When using these ICs, consider the following points:

The relations between  $I_{OUT}$  (Output Current) and ESR of an output capacitor are shown below.

The conditions when the white noise level is under  $40\mu\text{V}$  (Avg.) are marked as the hatched area in the graph.

### Measurement conditions

$V_{IN} = \text{Set } V_{OUT} + 1\text{V}$

Frequency Band: 10Hz to 2MHz

Temperature:  $-40^{\circ}\text{C}$  to  $85^{\circ}\text{C}$

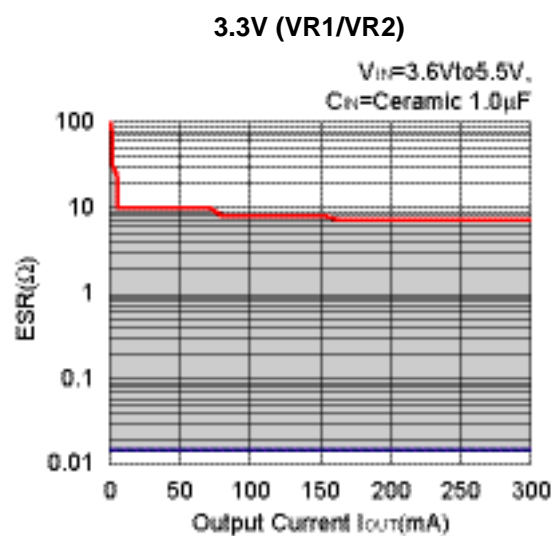
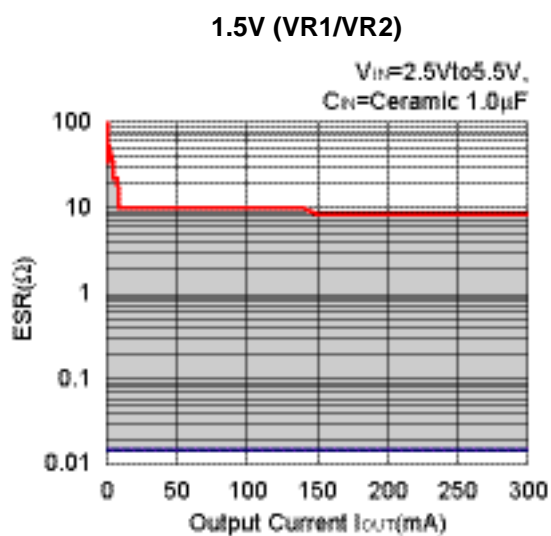



1. The products and the product specifications described in this document are subject to change or discontinuation of production without notice for reasons such as improvement. Therefore, before deciding to use the products, please refer to our sales representatives for the latest information thereon.
2. The materials in this document may not be copied or otherwise reproduced in whole or in part without prior written consent of our company.
3. Please be sure to take any necessary formalities under relevant laws or regulations before exporting or otherwise taking out of your country the products or the technical information described herein.
4. The technical information described in this document shows typical characteristics of and example application circuits for the products. The release of such information is not to be construed as a warranty of or a grant of license under our company's or any third party's intellectual property rights or any other rights.
5. The products listed in this document are intended and designed for use as general electronic components in standard applications (office equipment, telecommunication equipment, measuring instruments, consumer electronic products, amusement equipment etc.). Those customers intending to use a product in an application requiring extreme quality and reliability, for example, in a highly specific application where the failure or misoperation of the product could result in human injury or death (aircraft, spacevehicle, nuclear reactor control system, traffic control system, automotive and transportation equipment, combustion equipment, safety devices, life support system etc.) should first contact us.
6. We are making our continuous effort to improve the quality and reliability of our products, but semiconductor products are likely to fail with certain probability. In order to prevent any injury to persons or damages to property resulting from such failure, customers should be careful enough to incorporate safety measures in their design, such as redundancy feature, fire containment feature and fail-safe feature. We do not assume any liability or responsibility for any loss or damage arising from misuse or inappropriate use of the products.
7. Anti-radiation design is not implemented in the products described in this document.
8. The X-ray exposure can influence functions and characteristics of the products. Confirm the product functions and characteristics in the evaluation stage.
9. WLCSP products should be used in light shielded environments. The light exposure can influence functions and characteristics of the products under operation or storage.
10. There can be variation in the marking when different AOI (Automated Optical Inspection) equipment is used. In the case of recognizing the marking characteristic with AOI, please contact our sales or our distributor before attempting to use AOI.
11. Please contact our sales representatives should you have any questions or comments concerning the products or the technical information.



**Nisshinbo Micro Devices Inc.**

**Official website**

<https://www.nisshinbo-microdevices.co.jp/en/>

**Purchase information**

<https://www.nisshinbo-microdevices.co.jp/en/buy/>

