

## INA185EVM

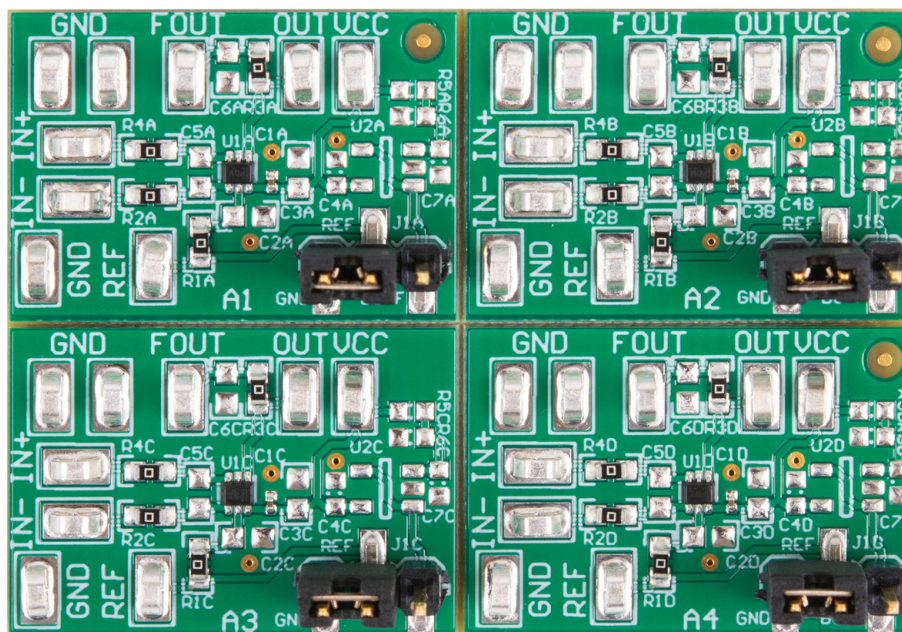

This user's guide describes the characteristics, operation, and use of the INA185 evaluation module (EVM). This EVM is designed to evaluate the performance of the [INA185A1](#), [INA185A2](#), [INA185A3](#), and [INA185A4](#) voltage output current-shunt monitors in a variety of configurations. Throughout this document, the terms evaluation board, evaluation module, and EVM are synonymous with the INA185EVM. This document includes a schematic, reference printed-circuit board (PCB) layouts, and a complete bill of materials.

### Contents

|   |  |   |
|---|--|---|
| 1 | Overview .....                                     | 3 |
| 2 | Hardware.....                                      | 4 |
| 3 | Quick Start Setup and Use .....                    | 4 |
| 4 | Circuitry .....                                    | 5 |
| 5 | Reference Voltage Setup .....                      | 6 |
| 6 | Schematic, PCB Layout, and Bill of Materials ..... | 7 |

### List of Figures

|   |                                    |   |
|---|------------------------------------|---|
| 1 | INA185EVM Schematic.....           | 7 |
| 2 | INA185EVM Top Overlay.....         | 8 |
| 3 | INA185EVM Bottom Overlay .....     | 8 |
| 4 | INA185EVM Top Solder Mask .....    | 8 |
| 5 | INA185EVM Top Layer .....          | 8 |
| 6 | INA185EVM Bottom Layer .....       | 8 |
| 7 | INA185EVM Bottom Solder Mask ..... | 8 |
| 8 | INA185EVM Drill Drawing .....      | 9 |

### List of Tables

|   |                                    |    |
|---|------------------------------------|----|
| 1 | INA185Ax Gain Option Summary ..... | 3  |
| 2 | INA185EVM Kit Contents.....        | 3  |
| 3 | Related Documentation .....        | 3  |
| 4 | Bill of Materials .....            | 10 |

### Trademarks

All trademarks are the property of their respective owners.

## 1 Overview

The INA185 current-shunt monitor (also called current-sense amplifier) can sense voltage drops across shunts at common-mode voltages from  $-0.2\text{ V}$  to  $+26\text{ V}$ , independent of the supply voltage. Four fixed gain options are available: 20 V/V, 50 V/V, 100 V/V, and 200 V/V. The INA185 has a reference pin that enables bidirectional current measurements. The device operates from a single 2.7-V to 5.5-V power supply, drawing a maximum of 260  $\mu\text{A}$  of supply current per amplifier channel.

The INA185 devices are currently available in a SOT-563 surface-mount package. [Table 1](#) lists the available gain options.

**Table 1. INA185Ax Gain Option Summary**

| PRODUCT  | GAIN (V/V) |
|----------|------------|
| INA185A1 | 20         |
| INA185A2 | 50         |
| INA185A3 | 100        |
| INA185A4 | 200        |

### 1.1 Kit Contents

[Table 2](#) lists the contents of the INA185EVM kit. Contact the nearest [Texas Instruments Product Information Center](#) if any components are missing. TI highly recommends checking the INA185 family product folder on the TI website at [www.ti.com](http://www.ti.com) for further information regarding this product.

**Table 2. INA185EVM Kit Contents**

| ITEM                 | QUANTITY |
|----------------------|----------|
| INA185EVM Test Board | 1        |

### 1.2 Related Documentation From Texas Instruments

The following document provides information regarding TI's integrated circuits used in the assembly of the INA185EVM. This user's guide is available from the TI website under literature number (SBOU167). Any letter appended to the literature number corresponds to the document revision that is current at the time of the writing of this document. Newer revisions are available from [www.ti.com](http://www.ti.com) or the Texas Instruments' Literature Response Center at (800) 477-8924 or the Product Information Center at (972) 644-5580. When ordering, identify the document by both title and literature number.

**Table 3. Related Documentation**

| DOCUMENT                                  | LITERATURE NUMBER       |
|---|-------------------------|
| <a href="#">INA185</a> Product data sheet | <a href="#">SBOS378</a> |

## 2 Hardware

The INA185 is an integrated, op amp-based current sense circuit that provides ease of use and high performance. The INA185EVM is intended to provide basic functional evaluation of this device family. The board layout is neither intended to be a model for the target circuit, nor is it laid out for electromagnetic compatibility (EMC) testing. The INA185EVM consists of one PCB that can be cut into four individual PCB segments, one for each of the four device gain options.

### 2.1 Features

The layout of the INA185EVM printed-circuit board (PCB) is designed to provide the following features:

- Evaluation of all gain options for the INA185
- Ease of access to device pins with test points
- Capability to evaluate high-side and low-side configurations
- Capability to provide a buffered reference through a user defined voltage divider

See the INA185 data sheet ([SBOS378](#)) for comprehensive information about the INA185 family of devices.

## 3 Quick Start Setup and Use

The following instructions show how to set up and use the INA185 devices with the INA185EVM. For the circuits in the following instructions, x = A to D.

- Step 1. Connect an external dc supply voltage between 2.7-V and 5.5-V to the VCC test point TP2x, and connect the ground reference of that supply to one of the GND test points: TP7x, TP8x, or TP9x.
- Step 2. The REF pin is connected to the GND pin in the default board. The voltage applied at the reference input varies depending on how the device is going to be used. Further details regarding the use of the reference voltage are discussed later in this document.
- Step 3. Connect the input as described in [Section 3.1](#).

### 3.1 Measurements

The INA185EVM can either simulate the voltage developed across a sense resistor based on a given set of system conditions, or connect remotely to an existing shunt already included in a user application.

The following procedures are used to configure a measurement evaluation without a shunt. For the circuits in the following instructions, x = A to D.

- Step 1. Connect a differential voltage to the IN+ (TP6x) and IN- (TP3x) test points. With the reference voltage set at ground, make sure that the IN+ pin is the more positive of the two inputs.
- Step 2. Measure the output voltage at the OUT test point (TP4x or TP5x).

---

**NOTE:** The output voltage is equal to the gain of the device multiplied by the differential voltage measured directly at the device input pins.

---

## 4 Circuitry

This section summarizes the INA185EVM components. For the following circuits, x = A to D.

### 4.1 C1x, J1x, R1x, and TP1x

C1x and R1x form a low-pass RC filter to the source that supplies the INA185 REF pin. By default, no filter is installed, with R1x shorted by a 0- $\Omega$  resistor, and C1x not populated. J1x is a jumper that conveniently allows the user to short the INA185 reference to ground, connect directly to an external power supply, or short to a voltage set by a buffered voltage divider.

### 4.2 C2x and C3x, and TP2x

C2x is a 0.1- $\mu$ F supply bypass capacitor for the INA185, U1x. The C2x footprint size, 0201, was chosen in order to reduce overall layout size. A 0.1- $\mu$ F capacitor is required for proper operation of the INA185, and the user typically will not need to replace or adjust C2x. C3x is a footprint for an additional supply bypass capacitor that the user can populate to further stabilize the supply. TP2x allows the user to connect an external supply to the INA185 VS pin.

### 4.3 C4x

C4x is a 0.1- $\mu$ F supply bypass capacitor for the optional INA185 reference pin buffer, U2x.

### 4.4 C5x, R2x, and R4x

C4x, R2x, and R4x form a differential mode filter to the input of the INA185, U1x. By default, this filter is not installed, with R2x and R4x shorted by a 0- $\Omega$  resistor, and C4x not populated. If this filter is installed, R2x and R4x must be less than 10  $\Omega$  with low tolerance ( $\leq 1\%$ ) in order to minimize measurement error.

### 4.5 C6x, R3x, TP4x, and TP5x

C3x and R3x form a low-pass filter on the output of the INA185, U1x. By default, no filter is installed with R3x shorted by a 0- $\Omega$  resistor, and C6x not populated. TP4x shows unfiltered output. By default, TP5x also shows unfiltered output, but with R3 and C6 populated, TP5x shows filtered output.

### 4.6 C7x, R5x, and R6x

C7x and R5x form a low-pass filter to the input of the optional reference buffer. R5x and R6x form a voltage divider that sets a desired reference voltage.

### 4.7 U1x

U1x is the INA185 current shunt monitor. Four gain-option segments are supplied within the INA185EVM board. Each segment is populated with one of the available device gains. This configuration enables users to test the devices and determine the best gain setting for a given application. For x = A to D, the gain is 20 V/V, 50 V/V, 100 V/V, and 200 V/V, respectively.

The following is a list of the factors involved in selecting the appropriate device:

- The differential input voltage is applied across the inputs, or developed based on the load current that flows through the shunt resistor.
- The limiting factor that requires attention to be given to device selection is the output voltage.
- The selected device must allow the output voltage to remain within the acceptable range after the developed input voltage is amplified by the respective device gain. The output voltage must remain within the range of 10 mV greater than ground to 100 mV less than the supply voltage.
- An output less than the minimum allowable output requires a device with a higher gain. Likewise, an output greater than the maximum allowable output requires a device with a lower gain.

### 4.8 U2x

U2x is a SOT-23 footprint for a buffer amplifier. By default, this part is not populated.

## 5 Reference Voltage Setup

The INA185 allows for the use of an external reference. This reference determines how the output responds to certain input conditions. The reference also enables these devices to be used in unidirectional and bidirectional applications.

### 5.1 Unidirectional Mode

*Unidirectional* refers to a load current that flows in only one direction.

By default, each EVM board segment (one segment for each gain option) has the INA185 REF pin connected to GND through a 0- $\Omega$  resistor and a jumper. This connection sets the INA185 for unidirectional measurements. If bidirectional measurements are required, the EVM board segments can be modified to add external voltages to the REF pins.

### 5.2 Bidirectional Mode

*Bidirectional* refers to a load current that flows in both directions.

The INA185 is able to measure bidirectional currents. The ability to measure current flowing in both directions is enabled by applying a voltage to the REF pin. The voltage applied to REF sets the output state that corresponds to the zero-input-level state. The output then responds by increasing to greater than REF for positive differential signals (relative to the IN $-$  pin), and by decreasing to less than REF for negative differential signals. This reference voltage applied to the REF pin can be set anywhere from 0 V to V+. For bidirectional applications, REF is typically set at midscale for an equal signal range in both current directions. However, REF is set at a voltage other than midscale when the bidirectional current and corresponding output signal do not have to be symmetrical.

### 5.3 REF Pin Configuration

Jumper connection J1x configures the respective EVM board segment for either unidirectional or bidirectional operation. Shorting the left and middle pins of J1x sets the board for unidirectional measurements. Removing the jumper and applying a voltage between 0 V to V+ to the middle pin of J1x sets the board to a bidirectional measurement with the zero current output centered at the applied voltage. Alternatively, install C4x, R5x, R6x, and U2x to provide a buffered voltage divider input from the supply to set the reference voltage. For the buffered divider, install the jumper on the middle and right pins of J1x.



## 6.2 PCB Layout

Figure 2 through Figure 8 illustrate the PCB layout for the INA185EVM.

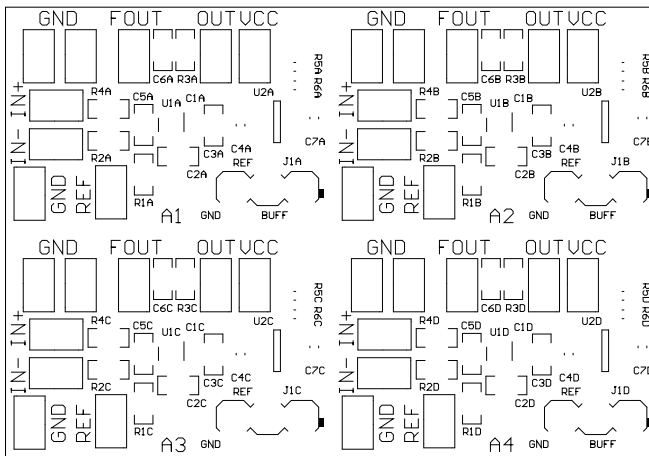

Figure 2. INA185EVM Top Overlay

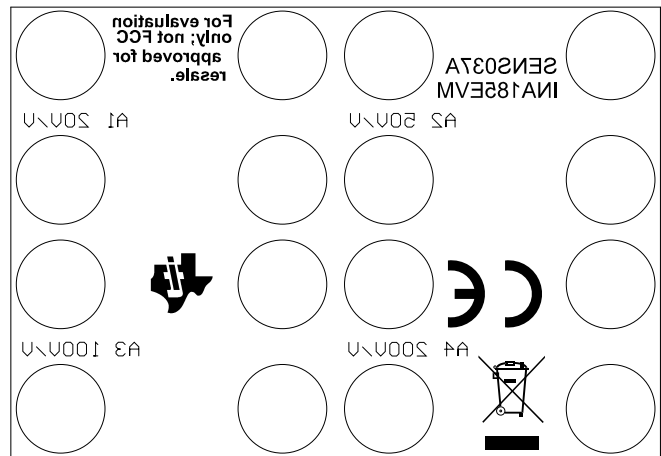

Figure 3. INA185EVM Bottom Overlay

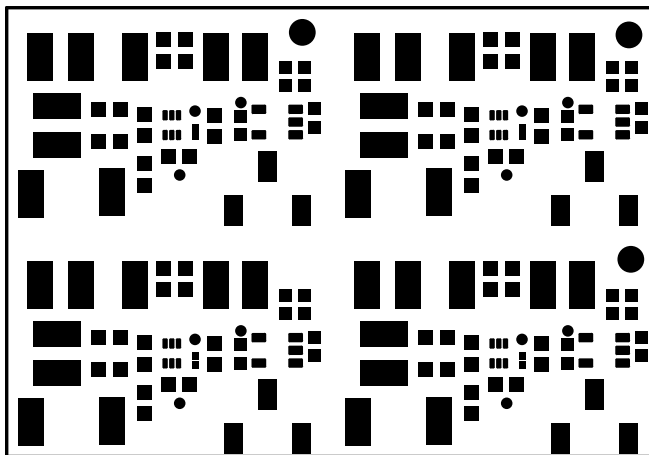

Figure 4. INA185EVM Top Solder Mask

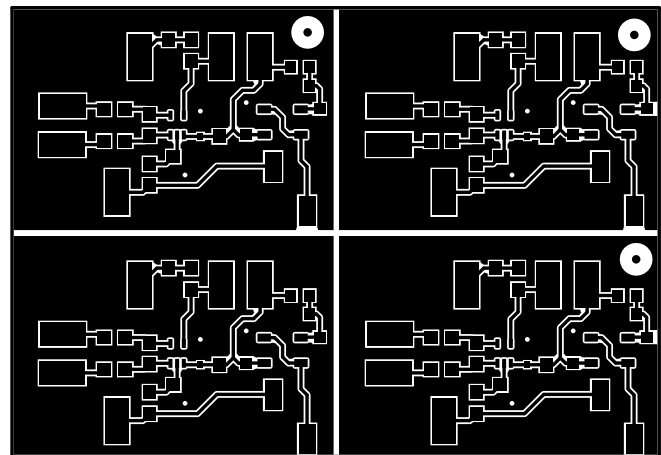

Figure 5. INA185EVM Top Layer

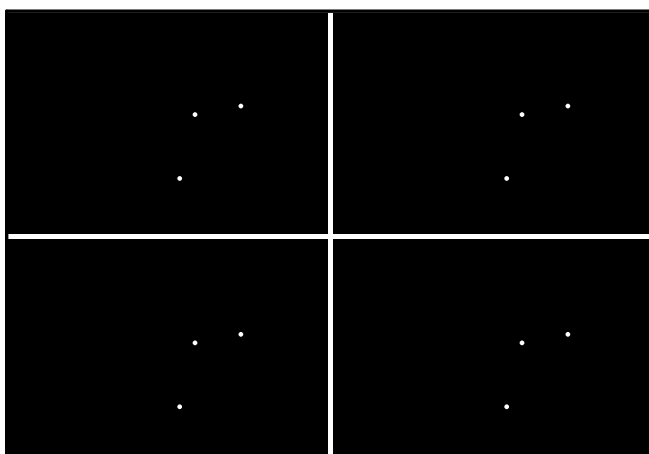

Figure 6. INA185EVM Bottom Layer

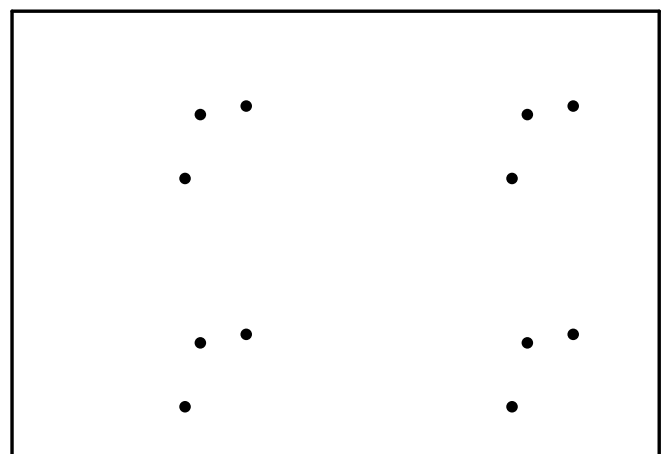
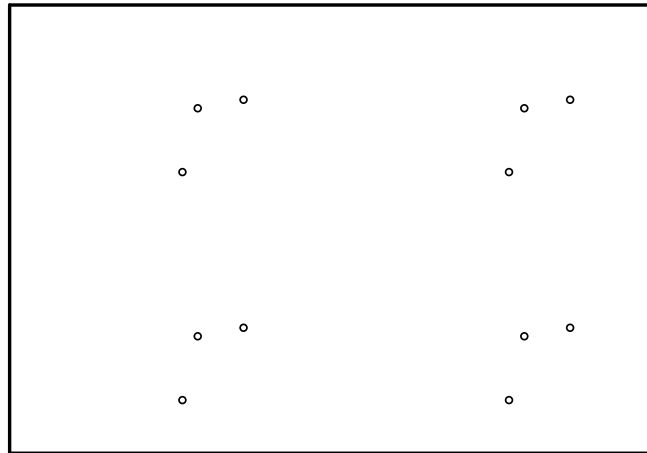

Figure 7. INA185EVM Bottom Solder Mask





**Figure 8. INA185EVM Drill Drawing**

### 6.3 Bill of Materials

Table 4 provides the parts list for the INA185EVM.

**Table 4. Bill of Materials**

| DESIGNATOR   | QUANTITY | VALUE  | DESCRIPTION   | PACKAGE REFERENCE            | PART NUMBER         | MANUFACTURER              |
|--|----------|--------|---|------------------------------|---------------------|---------------------------|
| !PCB   | 1        |        | Printed-Circuit Board   |                              | SENS037             | Any                       |
| C1A, C1B, C1C, C1D   | 4        | 0.1uF  | CAP, CERM, 0.1 uF, 25 V, +/- 10%, X6S, 0201   | 0201                         | GRM033C81E104KE14D  | MuRata                    |
| H1A, H1B, H1C, H1D, H2A, H2B, H2C, H2D, H3A, H3B, H3C, H3D, H4A, H4B, H4C, H4D   | 16       | 0      | Bumpon, Hemisphere, 0.25 X 0.075, Clear   | 75x250 mil                   | SJ5382000Z0EA       | 3M                        |
| J1A, J1B, J1C, J1D   | 4        | SMT    | Header, 2.54mm, 3x1, Gold, SMT  | Header, 2.54mm, 3x1, SMT     | M20-8770342         | Harwin                    |
| R1A, R1B, R1C, R1D, R2A, R2B, R2C, R2D, R3A, R3B, R3C, R3D, R4A, R4B, R4C, R4D   | 16       | 0      | RES, 0, 1%, 0.1 W, AEC-Q200 Grade 0, 0603   | 0603                         | RMCF0603ZT0R00      | Stackpole Electronics Inc |
| SH-J1, SH-J2, SH-J3, SH-J4   | 4        |        | Shunt, 100mil, Gold plated, Black   | Shunt 2 pos. 100 mil         | 881545-2            | TE Connectivity           |
| TP1A, TP1B, TP1C, TP1D, TP2A, TP2B, TP2C, TP2D, TP3A, TP3B, TP3C, TP3D, TP4A, TP4B, TP4C, TP4D, TP5A, TP5B, TP5C, TP5D, TP6A, TP6B, TP6C, TP6D, TP7A, TP7B, TP7C, TP7D, TP8A, TP8B, TP8C, TP8D, TP9A, TP9B, TP9C, TP9D | 36       |        | Test Point, Miniature, SMT  | Testpoint_Keystone_Miniature | 5015                | Keystone                  |
| U1A  | 1        |        | Bidirectional, Precision Low- and High-Side Voltage Output, Current-Sense Amplifier, DRL0006A (SOT-5X3-6) | DRL0006A                     | INA185A1IDRLR       | Texas Instruments         |
| U1B  | 1        |        | Bidirectional, Precision Low- and High-Side Voltage Output, Current-Sense Amplifier, DRL0006A (SOT-5X3-6) | DRL0006A                     | INA185A2IDRLR       | Texas Instruments         |
| U1C  | 1        |        | Bidirectional, Precision Low- and High-Side Voltage Output, Current-Sense Amplifier, DRL0006A (SOT-5X3-6) | DRL0006A                     | INA185A3IDRLR       | Texas Instruments         |
| U1D  | 1        |        | Bidirectional, Precision Low- and High-Side Voltage Output, Current-Sense Amplifier, DRL0006A (SOT-5X3-6) | DRL0006A                     | INA185A4IDRLR       | Texas Instruments         |
| C2A, C2B, C2C, C2D, C5A, C5B, C5C, C5D, C6A, C6B, C6C, C6D   | 0        | 1000pF | CAP, CERM, 1000 pF, 100 V, +/- 10%, X7R, 0603   | 0603                         | C1608X7R2A102K080AA | TDK                       |
| C3A, C3B, C3C, C3D   | 0        | 10uF   | CAP, CERM, 1000 pF, 100 V, +/- 10%, X7R, 0603   | 0603                         | GRT188R61E106ME13D  | MuRata                    |
| C4A, C4B, C4C, C4D, C7A, C7B, C7C, C7D   | 0        | 0.1uF  | CAP, CERM, 10 uF, 25 V, +/- 20%, X5R, 0603  | 0603                         | 06035C104KAT2A      | AVX                       |
| R5A, R5B, R5C, R5D, R6A, R6B, R6C, R6D   | 0        | 10.0k  | CAP, CERM, 0.1 uF, 50 V, +/- 10%, X7R, 0603   | 0603                         | RC0603FR-0710KL     | Yageo                     |
| U2A, U2B, U2C, U2D   | 0        |        | 1-MHz, Low-Power Operational Amplifier for Cost-Sensitive Systems, DBV0005A (SOT-23-5)                    | DBV0005A                     | TLV6001IDBVR        | Texas Instruments         |

## IMPORTANT NOTICE AND DISCLAIMER

TI PROVIDES TECHNICAL AND RELIABILITY DATA (INCLUDING DATA SHEETS), DESIGN RESOURCES (INCLUDING REFERENCE DESIGNS), APPLICATION OR OTHER DESIGN ADVICE, WEB TOOLS, SAFETY INFORMATION, AND OTHER RESOURCES "AS IS" AND WITH ALL FAULTS, AND DISCLAIMS ALL WARRANTIES, EXPRESS AND IMPLIED, INCLUDING WITHOUT LIMITATION ANY IMPLIED WARRANTIES OF MERCHANTABILITY, FITNESS FOR A PARTICULAR PURPOSE OR NON-INFRINGEMENT OF THIRD PARTY INTELLECTUAL PROPERTY RIGHTS.

These resources are intended for skilled developers designing with TI products. You are solely responsible for (1) selecting the appropriate TI products for your application, (2) designing, validating and testing your application, and (3) ensuring your application meets applicable standards, and any other safety, security, regulatory or other requirements.

These resources are subject to change without notice. TI grants you permission to use these resources only for development of an application that uses the TI products described in the resource. Other reproduction and display of these resources is prohibited. No license is granted to any other TI intellectual property right or to any third party intellectual property right. TI disclaims responsibility for, and you will fully indemnify TI and its representatives against, any claims, damages, costs, losses, and liabilities arising out of your use of these resources.

TI's products are provided subject to [TI's Terms of Sale](#) or other applicable terms available either on [ti.com](http://ti.com) or provided in conjunction with such TI products. TI's provision of these resources does not expand or otherwise alter TI's applicable warranties or warranty disclaimers for TI products.

TI objects to and rejects any additional or different terms you may have proposed.

Mailing Address: Texas Instruments, Post Office Box 655303, Dallas, Texas 75265  
Copyright © 2022, Texas Instruments Incorporated