

GaAs MMIC SMT PASSIVE FREQUENCY DOUBLER, 0.7 - 2.4 GHz INPUT



Typical Applications

The HMC156AC8 is suitable for:

- Wireless Local Loop
- LMDS, VSAT, and Point-to-Point Radios
- UNII & HiperLAN
- Test Equipment

Features

- Conversion Loss: 15 dB
- Fo, 3Fo, 4Fo Isolation: 38 dB
- Input Drive Level: 10 to 20 dBm

Functional Diagram

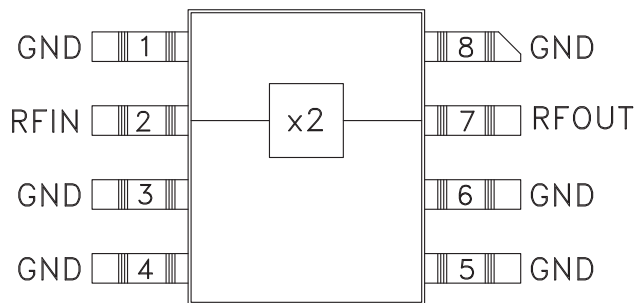

General Description

The HMC156AC8 is a miniature frequency doubler in a non-hermetic ceramic surface mount package. Suppression of undesired fundamental and higher order harmonics is 38 dB typical with respect to input signal levels. The doubler uses the same diode/balun technology used in Hittite MMIC mixers, features small size and requires no DC bias.

Electrical Specifications, $T_A = +25^\circ\text{C}$, As a Function of Drive Level

Parameter	Input = +10 dBm			Input = +15 dBm			Input = +20 dBm			Units
	Min.	Typ.	Max.	Min.	Typ.	Max.	Min.	Typ.	Max.	
Frequency Range, Input	1.1 - 2.1			0.8 - 2.4			0.7 - 2.3			GHz
Frequency Range, Output	2.2 - 4.2			1.6 - 4.8			1.4 - 4.6			GHz
Conversion Loss		17	22		15	20		15	20	dB
FO Isolation (with respect to input level)	42	47		43	47		27	35		dB
3FO Isolation (with respect to input level)	45	55		44	55		29	40		dB
4FO Isolation (with respect to input level)	28	38		31	38		25	35		dB

Information furnished by Analog Devices is believed to be accurate and reliable. However, no responsibility is assumed by Analog Devices for its use, nor for any infringements of patents or other rights of third parties that may result from its use. Specifications subject to change without notice. No license is granted by implication or otherwise under any patent or patent rights of Analog Devices. Trademarks and registered trademarks are the property of their respective owners.

For price, delivery, and to place orders: Analog Devices, Inc., One Technology Way, P.O. Box 9106, Norwood, MA 02062-9106 Phone: 781-329-4700 • Order online at www.analog.com Application Support: Phone: 1-800-ANALOG-D

GaAs MMIC SMT PASSIVE FREQUENCY DOUBLER, 0.7 - 2.4 GHz INPUT



Conversion Gain vs. Drive Level

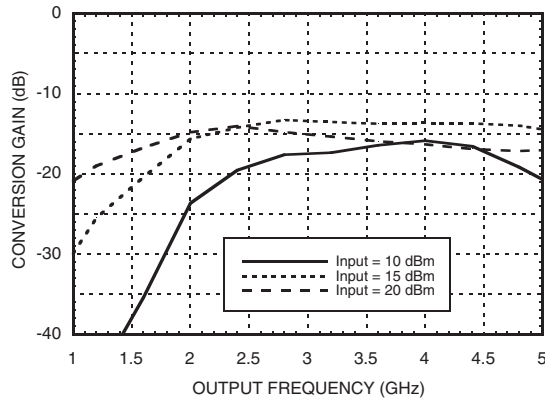

Isolation @ +15 dBm Drive Level*

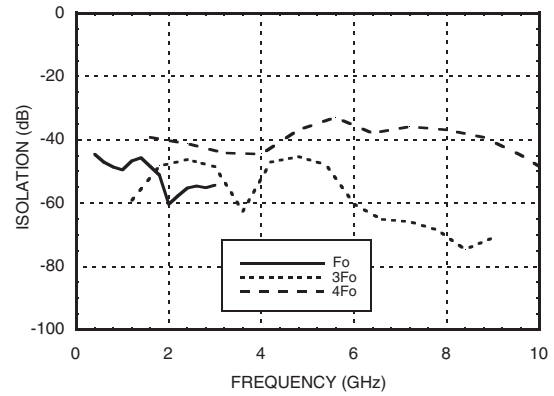

*With respect to input level

Input Return Loss vs. Drive Level

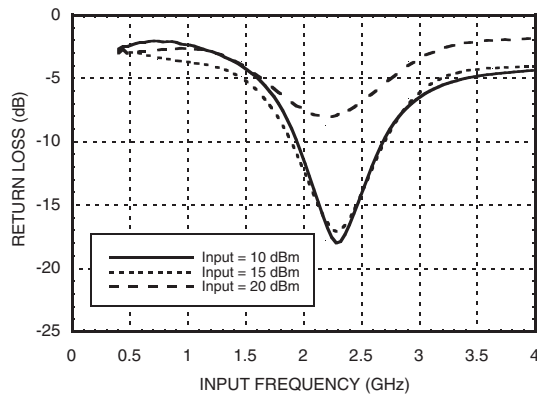

Output Return Loss @ +15 Drive Level

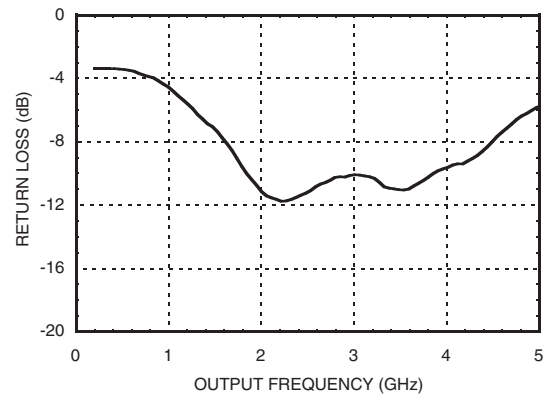

Absolute Maximum Ratings

Input Drive	+27 dBm
Storage Temperature	-65 to +150 °C
Operating Temperature	-40 to +85 °C



**ELECTROSTATIC SENSITIVE DEVICE
OBSERVE HANDLING PRECAUTIONS**

GaAs MMIC SMT PASSIVE FREQUENCY DOUBLER, 0.7 - 2.4 GHz INPUT



Pin Descriptions

Pin Number	Function	Description	Interface Schematic
1, 3 - 6, 8	GND	All ground leads must be soldered to PCB RF/DC ground.	
2	RFIN	Pin is DC coupled and matched to 50 Ohms.	
7	RFOUT	Pin is DC coupled and matched to 50 Ohms.	

Outline Drawing

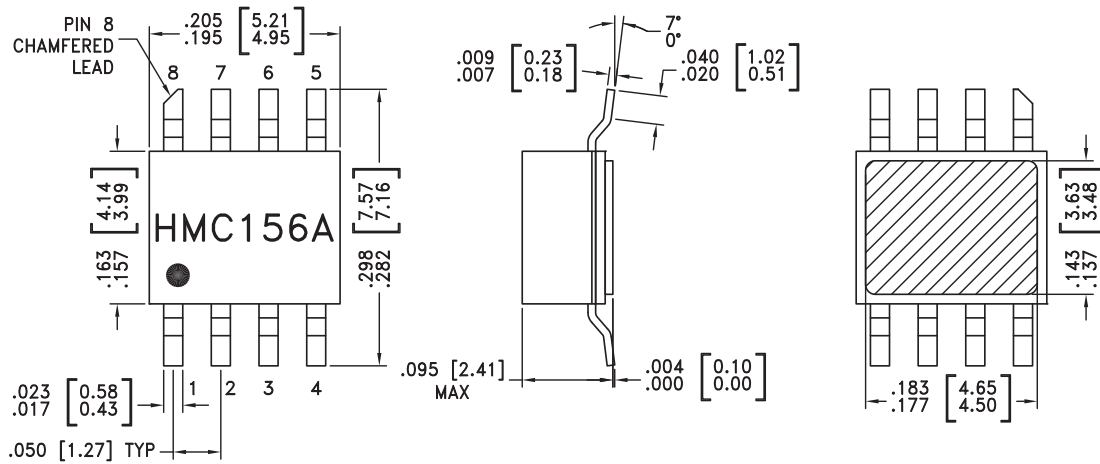

NOTES:

1. PACKAGE BODY MATERIAL: WHITE ALUMINA 92%
2. LEAD, PACKAGE BOTTOM MATERIAL: COPPER
3. PLATING: ELECTROLYTIC GOLD 100 - 200 MICROINCHES OVER ELECTROLYTIC NICKEL 100 TO 200 MICROINCHES.
4. DIMENSIONS ARE IN INCHES [MILLIMETERS].
5. PACKAGE LENGTH AND WIDTH DIMENSIONS DO NOT INCLUDE LID SEAL PROTRUSION .005 PER SIDE.
6. ALL GROUND LEADS AND GROUND PADDLE MUST BE SOLDERED TO PCB PF GROUND.

GaAs MMIC SMT PASSIVE FREQUENCY DOUBLER, 0.7 - 2.4 GHz INPUT



Evaluation PCB

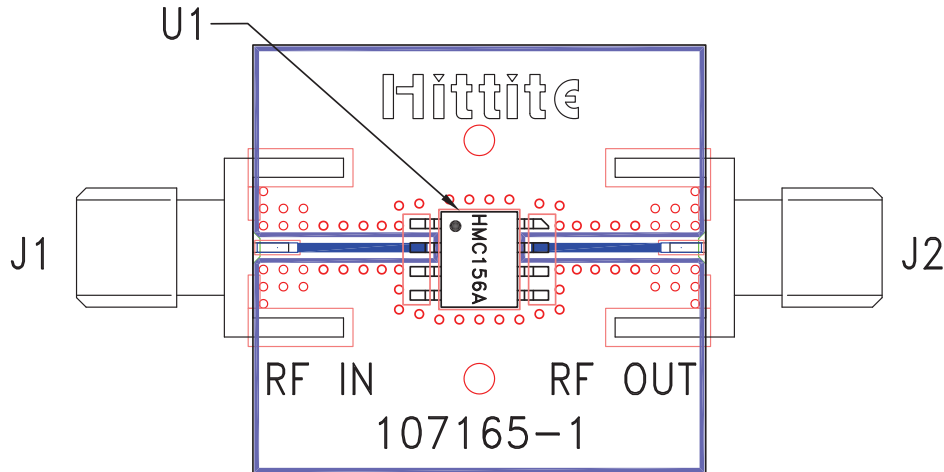

List of Materials for Evaluation PCB 107196 [1]

Item	Description
J1, J2	PCB Mount SMA Connector
U1	HMC156AC8, Doubler
PCB [2]	107165 Eval Board

[1] Reference this number when ordering complete evaluation PCB

[2] Circuit Board Material: Rogers 4350

The circuit board used in the application should be generated with proper RF circuit design techniques. Signal lines should have 50 ohm impedance while the package ground leads and exposed paddle should be connected directly to the ground plane similar to that shown. The evaluation circuit board shown is available from Hittite upon request.