

FEATURES

Ultralow Bias Current: 75 fA max (AD515AL)
150 fA max (AD515AK)
300 fA max (AD515AJ)

Low Power: 1.5 mA max Quiescent Current
(0.6 mA typ)

Low Offset Voltage: 1.0 mV max (AD515AK & L)

Low Drift: 15 $\mu\text{V}/^\circ\text{C}$ max (AD515AK)

Low Noise: 4 μV p-p, 0.1 Hz to 10 Hz

PRODUCT DESCRIPTION

The AD515A is a monolithic FET-input operational amplifier with a guaranteed maximum input bias current of 75 fA (AD515AL). The AD515A is a monolithic successor to the industry standard AD515 electrometer, and will replace the AD515 in most applications. The AD515A also delivers laser-trimmed offset voltage, low drift, low noise and low power, a combination of features not previously available in ultralow bias current circuits. All devices are internally compensated, protected against latch-up and are short circuit protected.

The AD515A's combination of low input bias current, low offset voltage and low drift optimizes it for a wide variety of electrometer and very high impedance buffer applications including photocurrent detection, vacuum ion-gage measurement, long-term precision integration and low drift sample/hold applications. This amplifier is also an excellent choice for all forms of biomedical instrumentation such as pH/pIon sensitive electrodes, very low current oxygen sensors, and high impedance biological microprobes. In addition, the low cost and pin compatibility of the AD515A with standard FET op amps will allow designers to upgrade the performance of present systems at little or no additional cost. The $10^{15} \Omega$ common-mode input impedance ensures that the input bias current is essentially independent of common-mode voltage.

As with previous electrometer amplifier designs from Analog Devices, the case is brought out to its own connection (Pin 8) so it can be independently connected to a point at the same potential as the input, thus minimizing stray leakage to the case. This feature will also shield the input circuitry from external noise and supply transients.

The AD515A is available in three versions of bias current and offset voltage, the "J", "K" and "L"; all are specified for rated performance from 0°C to $+70^\circ\text{C}$ and supplied in a hermetically sealed TO-99 package.

REV. A

Information furnished by Analog Devices is believed to be accurate and reliable. However, no responsibility is assumed by Analog Devices for its use, nor for any infringements of patents or other rights of third parties which may result from its use. No license is granted by implication or otherwise under any patent or patent rights of Analog Devices.

PIN CONFIGURATION

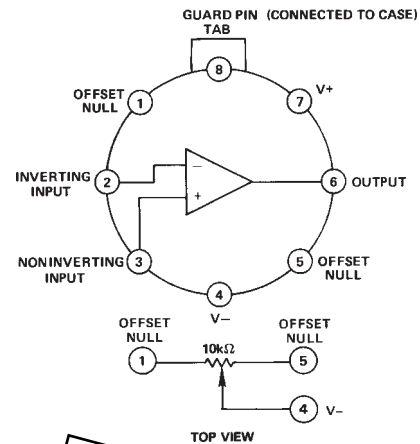

PRODUCT HIGHLIGHTS

- The AD515A provides subpicoampere bias currents in an integrated circuit amplifier.
 - The ultralow input bias currents are specified as the maximum measured at either input with the device fully warmed up on $\pm 15\text{ V}$ supplies at $+25^\circ\text{C}$ ambient with no heat sink. This parameter is 100% tested.
 - By using $\pm 5\text{ V}$ supplies, input bias current can typically be brought below 50 fA.
- The input offset voltage on all grades is laser trimmed, typically less than 500 μV .
 - The offset voltage drift is 15 $\mu\text{V}/^\circ\text{C}$ maximum on the K grade.
 - If additional pulling is desired, the amount required will have a minimal effect on offset drift (approximately 3 $\mu\text{V}/^\circ\text{C}$ per mV).
- The low quiescent current drain of 0.6 mA typical and 1.5 mA maximum, keeps self-heating effects to a minimum and renders the AD515A suitable for a wide range of remote probe applications.
- The combination of low input noise voltage and very low input noise current is such that for source impedances from $1\text{M} \Omega$ to $10^{11} \Omega$, the Johnson noise of the source will easily dominate the noise characteristic.

AD515A—SPECIFICATIONS (typical @ +25°C and $V_S = \pm 15$ V dc, unless otherwise noted)

Model	AD515AJ	AD515AK	AD515AL
OPEN-LOOP GAIN¹ $V_{OUT} = \pm 10$ V, $R_L \geq 2$ k Ω $R_L \geq 10$ k Ω $T_A =$ min to max $R_L \geq 2$ k Ω	20,000 V/V min 40,000 V/V min 15,000 V/V min	40,000 V/V min 100,000 V/V min 40,000 V/V min	25,000 V/V min 50,000 V/V min 25,000 V/V min
OUTPUT CHARACTERISTICS Voltage @ $R_L = 2$ k Ω , $T_A =$ min to max @ $R_L = 10$ k Ω , $T_A =$ min to max Load Capacitance ² Short-Circuit Current	± 10 V min (± 12 V typ) ± 12 V min (± 13 V typ) 1000 pF 10 mA min (20 mA typ)	* *	* *
FREQUENCY RESPONSE Unity Gain, Small Signal Full Power Response Slew Rate Inverting Unity Gain Overload Recovery Inverting Unity Gain	1 MHz 5 kHz min (50 kHz typ) 0.3 V/ μ s min (3.0 V/ μ s typ) 100 μ s max (2 μ s typ)	* * * *	* * * *
INPUT OFFSET VOLTAGE³ vs. Temperature, $T_A =$ min to max vs. Supply, $T_A =$ min to max	3.0 mV max (0.4 mV typ) 50 μV/$^{\circ}$C max 400 μV/V max (50 μV/V typ)	1.0 mV max (0.4 mV typ) 15 μV/$^{\circ}$C max 100 μV/V max	1.0 mV max (0.4 mV typ) 25 μV/$^{\circ}$C max 200 μV/V max
INPUT BIAS CURRENT Either Input ⁴	300 fA max	150 fA max	75 fA max
INPUT IMPEDANCE Differential $V_{DIFF} = \pm 1$ V Common Mode	1.6 pF 10 ³ Ω 0.8 pF 10 ⁵ Ω	* *	*
INPUT NOISE Voltage, 0.1 Hz to 10 Hz f = 10 Hz f = 100 Hz f = 1 kHz Current, 0.1 Hz to 10 Hz 10 Hz to 10 kHz	4.0 μ V (p-p) 75 nV/V/ $\sqrt{\text{Hz}}$ 55 nV/ $\sqrt{\text{Hz}}$ 50 nV/ $\sqrt{\text{Hz}}$ 0.007 pA (p-p) 0.01 pA rms	* * * * * *	* * * * * *
INPUT VOLTAGE RANGE Differential Common Mode, $T_A =$ min to max Common-Mode Rejection, $V_{IN} = \pm 10$ V Maximum Safe Input Voltage ⁵	± 20 V min ± 10 V min (+ 12 V, -11 typ) 66 dB min (94 dB typ) $\pm V_S$	* * 80 dB min *	* * 70 dB min *
POWER SUPPLY Rated Performance Operating Quiescent Current	± 15 V ± 5 V min (± 18 V max) 1.5 mA max (0.6 mA typ)	* * *	* *
TEMPERATURE Operating, Rated Performance Storage	0°C to + 70°C -65°C to +150°C	*	*
PACKAGE OPTION TO-99 (H-08A)	AD515AJH	AD515AKH	AD515ALH

NOTES

*Specifications same as AD515AJ.

¹Open Loop Gain is specified with or without pulling of V_{OS} .

²A conservative design would not exceed 750 pF of load capacitance.

³Input Offset Voltage specifications are guaranteed after 5 minutes of operation at $T_A = +25^{\circ}\text{C}$.

⁴Bias Current specifications are guaranteed after 5 minutes of operation at $T_A = +25^{\circ}\text{C}$. For higher temperatures, the current doubles every +10°C.

⁵If it is possible for the input voltage to exceed the supply voltage, a series protection resistor should be added to limit input current to 0.1 mA.

The input devices can handle overload currents of 0.1 mA indefinitely without damage. See next page.

Specifications shown in **boldface** are tested on all production units at final test. Specifications subject to change without notice.

CAUTION

ESD (electrostatic discharge) sensitive device. Electrostatic charges as high as 4000 V readily accumulate on the human body and test equipment and can discharge without detection. Although the AD515A features proprietary ESD protection circuitry, permanent damage may occur on devices subjected to high energy electrostatic discharges. Therefore, proper ESD precautions are recommended to avoid performance degradation or loss of functionality.



LAYOUT AND CONNECTIONS CONSIDERATIONS

The design of very high impedance measurement systems introduces a new level of problems associated with the reduction of leakage paths and noise pickup.

1. A primary consideration in high impedance system designs is to attempt to place the measuring device as near to the signal source as possible. This will minimize current leakage paths, noise pickup and capacitive loading. The AD515A, with its combination of low offset voltage (normally eliminating the need for trimming), low quiescent current (minimal source heating, possible battery operation), internal compensation and small physical size lends itself to installation at the signal source or inside a probe. As a result of the high load capacitance rating, the AD515A can comfortably drive a long signal cable.

2. The use of guarding techniques is essential to realizing the capability of the ultralow input currents of the AD515A. Guarding is achieved by applying a low impedance bootstrap potential to the outside of the insulation material surrounding the high impedance signal line. This bootstrap potential is held at the same level as that of the high impedance line, therefore, there is no voltage drop across the insulation and, hence, no leakage. The guard will also act as a shield to reduce noise pickup and serves an additional function of reducing the effective capacitance to the input line. The case of the AD515A is brought out separately to Pin 8 so it can also be connected to the guard potential. This technique virtually eliminates potential leakage paths across the package insulation, provides a noise shield for the sensitive circuitry and reduces common-mode input capacitance to about 0.8 pF. Figure 1 shows a proper printed circuit board layout for input guarding and connecting the case guard. Figures 2 and 3 show guarding connections for typical inverting and noninverting applications. If Pin 8 is not used for guarding, it should be connected to ground or a power supply to reduce noise.

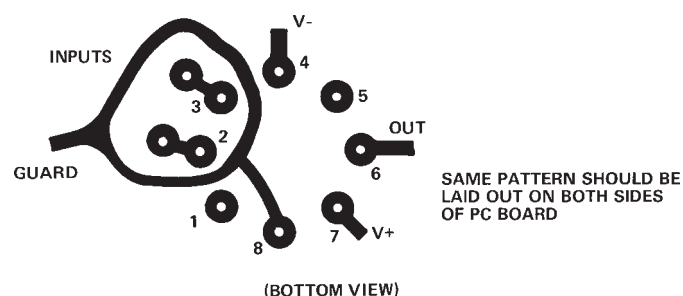

Figure 1. Board Layout for Guarding Inputs with Guarded TO-99 Package

3. Printed circuit board layout and construction is critical for achieving the ultimate in low leakage performance that the AD515A can deliver. The best performance will be realized by using a teflon IC socket for the AD515A; at a minimum a teflon standoff should be used for the high impedance lead. If this is not feasible, the input guarding scheme shown in Figure 1 will minimize leakage as much as possible; the guard ring should be applied to both sides of the board. The guard ring is connected to a low impedance potential at the same level as the inputs. High impedance signal lines should not be extended for any unnecessary length on a printed

circuit; to minimize noise and leakage, they must be carried in rigid, shielded cables.

4. Another important concern for achieving and maintaining low leakage currents is complete cleanliness of circuit boards and components. Completed assemblies should be washed thoroughly in a low residue solvent such as TMC Freon or high purity methanol, followed by a rinse with deionized water and nitrogen drying. If service is anticipated in a high contaminant or high humidity environment, a high dielectric conformal coating is recommended. All insulation materials except Kel-F or teflon will show rapid degradation of surface leakage at high humidities.

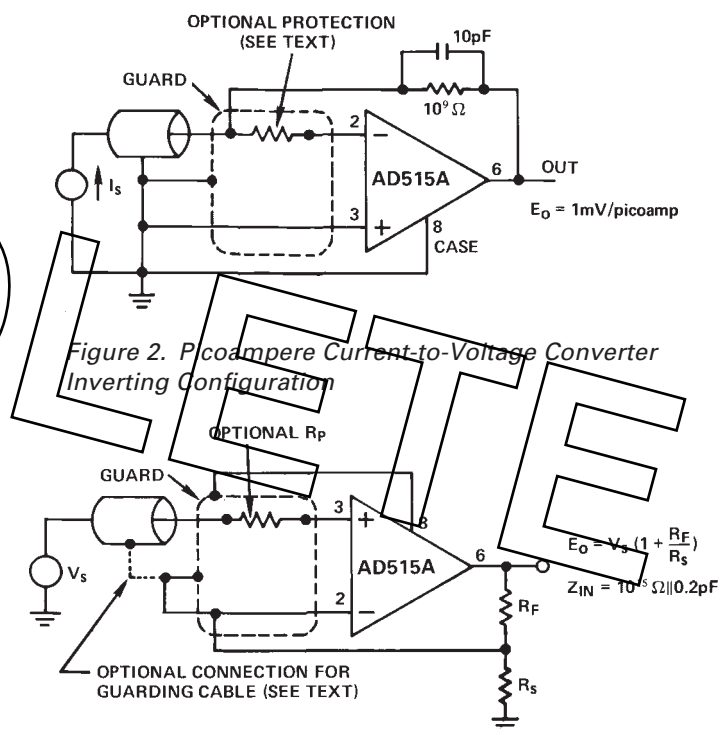

Figure 3. Very High Impedance Noninverting Amplifier

INPUT PROTECTION

The AD515A is guaranteed for a maximum safe input potential equal to the power supply potential.

Many instrumentation situations, such as flame detectors in gas chromatographs, involve measurement of low level currents from high voltage sources. In such applications, a sensor fault condition may apply a very high potential to the input of the current-to-voltage converting amplifier. This possibility necessitates some form of input protection. Many electrometer type devices, especially CMOS designs, can require elaborate Zener protection schemes that often compromise overall performance. The AD515A requires input protection only if the source is not current limited and, as such, is similar to many JFET-input designs. The failure mode would be overheating from excess current rather than voltage breakdown. If the source is not current limited, all that is required is a resistor in series with the affected input terminal so that the maximum overload current is 0.1 mA (for example, 1 M Ω for a 100 V overload). This simple scheme will cause no significant reduction in performance and give complete overload protection. Figures 2 and 3 show proper connections.

AD515A

COAXIAL CABLE AND CAPACITANCE EFFECTS

If it is not possible to attach the AD515A virtually on top of the signal source, considerable care should be exercised in designing the connecting lines carrying the high impedance signal. Shielded coaxial cable must be used for noise reduction, but use of coaxial cables for high impedance work can add problems from cable leakage, noise and capacitance. Only the best polyethylene or virgin teflon (not reconstituted) should be used to obtain the highest possible insulation resistance.

Cable systems should be made as rigid and vibration free as possible since cable movement can cause noise signals of three types, all significant in high impedance systems. Frictional movement of the shield over the insulation material generates a charge that is sensed by the signal line as a noise voltage. Low noise cable with graphite lubricant such as Amphenol 21-537 will reduce the noise, but short rigid lines are better. Cable movements will also make small changes in the internal cable capacitance and capacitance to other objects. Since the total charge on these capacitances cannot be instantly changed, a noise voltage results, as predicted from $\Delta V = Q/\Delta C$. Noise voltage is also generated by the motion of a conductor in a magnetic field.

The conductor-to-shield capacitance of coaxial cable is usually about 30 pF/foot. Charging this capacitance can cause considerable stretching of high impedance signal rise time, thus canceling the low input capacitance feature of the AD515A. There are two ways to circumvent this problem. For inverting signals or low level current measurements, the signal is carried on the line connected to the inverting input and shielded (guarded) by the ground line as shown in Figure 2. Since the signal is always at virtual ground, no voltage change is required and no capacitances are charged. In many circumstances, this will destabilize the circuit; if so, capacitance from output to inverting input will stabilize the circuit.

Noninverting and buffer situations are more critical since the signal line voltage and therefore charge will change, causing signal delay. This effect can be considerably reduced by connecting the cable shield to a guard potential instead of ground, an option shown in Figure 3. Since such a connection results in positive feedback to the input, the circuit may be destabilized and oscillate. If so, capacitance from positive input to ground must be added to make the net capacitance at Pin 3 positive. This technique can considerably reduce the effective capacitance that must be charged.

Typical Performance Curves

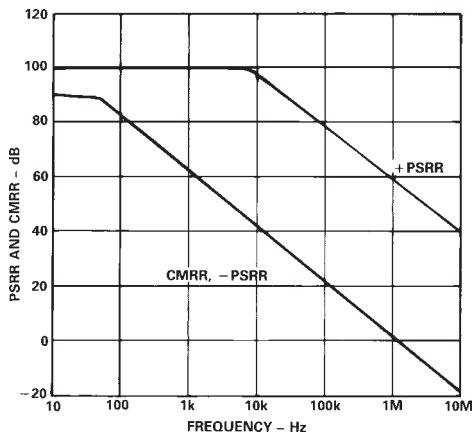

Figure 4. PSRR and CMRR vs. Frequency

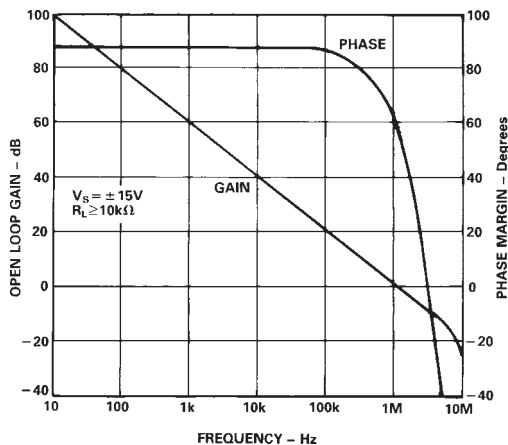

Figure 5. Open Loop Frequency Response

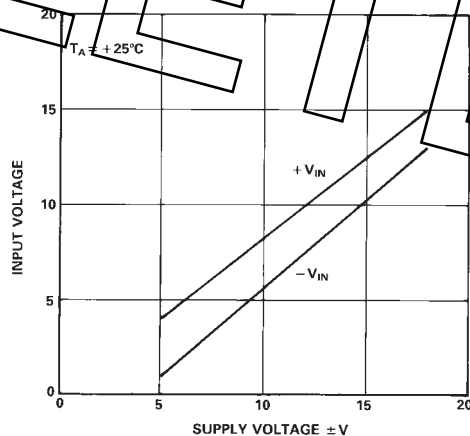

Figure 6. Input Common-Mode Range vs. Supply Voltage

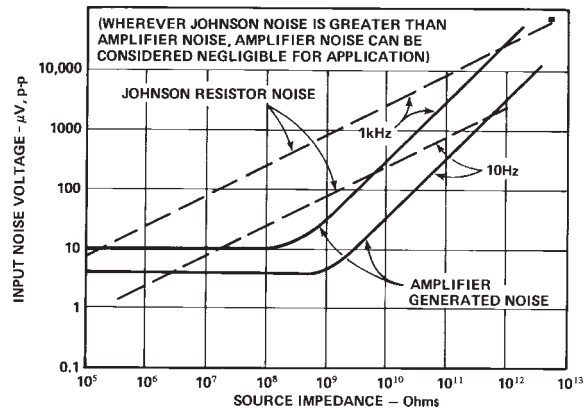

Figure 7. Peak-to-Peak Input Noise Voltage vs. Source Impedance and Bandwidth

ELECTROMETER APPLICATION NOTES

The AD515A offers subpicoampere input bias currents available in an integrated circuit package. This design will open up many new application opportunities for measurements from very high impedance and very low current sources. Performing accurate measurements of this sort requires careful attention to detail; the notes given here will aid the user in realizing the full measurement potential of the AD515A and perhaps extending its performance limits.

- As with all junction FET input devices, the temperature of the FETs themselves is critical in determining the input bias currents. Over the operating temperature range, the input bias currents closely follow a characteristic of doubling every 10°C; therefore, every effort should be made to minimize device operating temperature.
- The heat dissipation can be reduced initially by careful investigation of the application. First, if it is possible to reduce the required power supplies, this should be done since internal power consumption contributes the largest component of self-heating. To minimize this effect, the quiescent current of the AD515A has been reduced to less than 1 mA. Figure 8 shows typical input bias current and quiescent current versus supply voltage.
- Output loading effects, which are normally ignored, can cause a significant increase in chip temperature and therefore bias current. For example, a 2 kΩ load driven at 10 V at the output will cause at least an additional 25 mW dissipation in the output stage (and some in other stages) over the typical 24 mW, thereby at least doubling the effects of self-heating. The results of this form of additional power dissipation are demonstrated in Figure 9, which shows normalized input bias current versus additional power dissipated. Therefore, although many dc performance parameters are specified driving a 2 kΩ load, to reduce this additional dissipation, we recommend restricting the load resistance to be at least 10 kΩ.
- Figure 10 shows the AD515A's input current versus differential input voltage. Input current at either terminal stays below a few hundred fA until one input terminal is forced higher than 1 V to 1.5 V above the other terminal. Input current limits at 30 μA under these conditions.

AD515A CIRCUIT APPLICATION NOTES

The AD515A is quite simple to apply to a wide variety of applications because of the pretrimmed offset voltage and internal compensation, which minimize required external components and eliminate the need for adjustments to the device itself. The major considerations in applying this device are the external problems of layout and heat control which have already been discussed. In circuit situations employing the use of very high value resistors, such as low level current to voltage converters, electrometer operational amplifiers can be destabilized by a pole created by the small capacitance at the negative input. If this occurs, a capacitor of 2 pF to 5 pF in parallel with the resistor will stabilize the loop. A much larger capacitor may be used if desired to limit bandwidth and thereby reduce wide-band noise.

Selection of passive components employed in high impedance film or deposited ceramic oxide to obtain the best in low noise

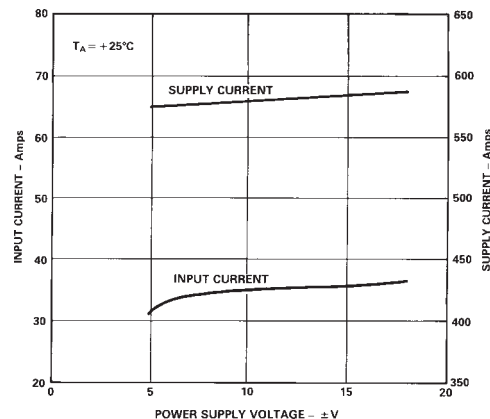

Figure 8. Input Bias Current and Supply Current vs. Supply Voltage

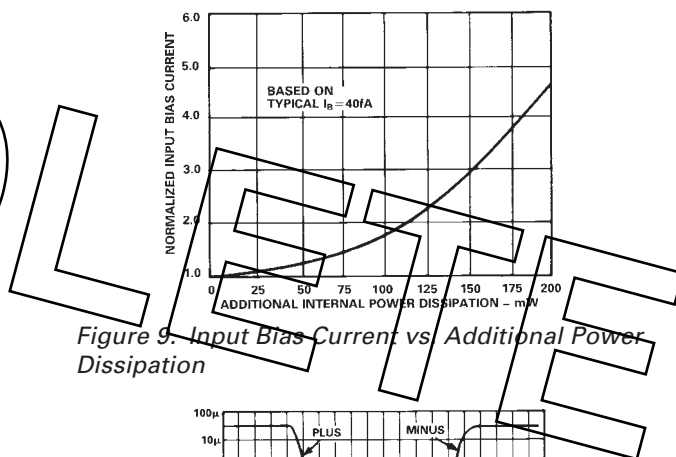

Figure 9. Input Bias Current vs. Additional Power Dissipation

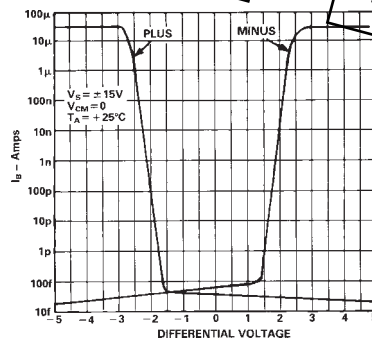

Figure 10. Input Bias Current vs. Differential Input Voltage

and high stability performance. The best packaging for high MΩ resistors is a glass body sprayed with silicone varnish to minimize humidity effects. These resistors must be handled very carefully to prevent surface contamination. Capacitors for any high impedance or long-term integration situation should be of a polystyrene formulation for optimum performance. Most other types have too low an insulation resistance, or high dielectric absorption.

Unlike situations involving standard operational amplifiers with much higher bias currents, balancing the impedances seen at the input terminals of the AD515A is usually unnecessary and probably undesirable. At the large source impedances, where these effects matter, obtaining quality matched resistors will be difficult. More important, instead of a cancelling effect, as with bias current, the noise voltage of the additional resistor will add by root-sum-of-squares to that of the other resistor thus increasing

AD515A

the total noise by about 40%. Noise currents driving the resistors also add, but in the AD515A are significant only above $10^{11} \Omega$.

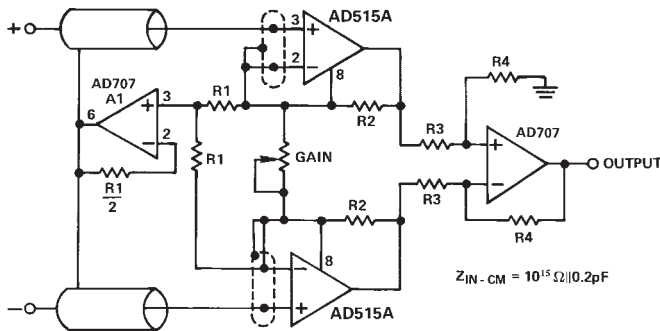

(ALL RESISTORS OF SAME NUMBER SHOULD BE MATCHED $\pm 0.1\%$)
 (BUFFER A1 BOOSTS COMMON MODE Z_{IN} BY DRIVING CABLE SHIELDS AT COMMON MODE VOLTAGE AND NEUTRALIZING CM CAPACITANCE)

Figure 11. Very High Impedance Instrumentation Amplifier

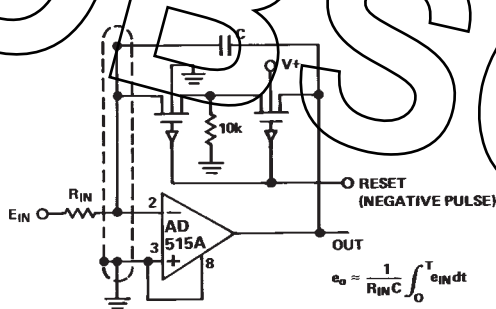

Figure 12. Low Drift Integrator and Low Leakage Guarded Reset

LOW LEVEL CURRENT-TO-VOLTAGE CONVERTERS

Figure 2 shows a standard low level current-to-voltage converter. To obtain higher sensitivity, it is obvious to simply use a higher value feedback resistor. However, high value resistors above $10^9 \Omega$ tend to be expensive, large, noisy and unstable. To avoid

this, it may be desirable to use a circuit configuration with output gain, as in Figure 13. The drawback is that input errors of offset voltage drift and noise are multiplied by the same gain, but the precision performance of the AD515A makes the trade-off easier.

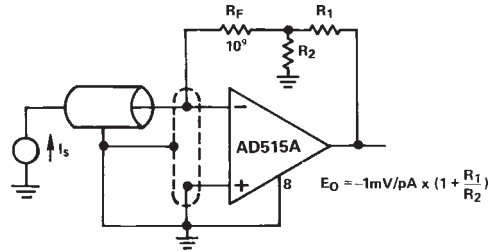

Figure 13. Picoampere to Voltage Converter with Gain

One of the problems with low level leakage current testing or low level current transducers (such as Clark oxygen sensors) is finding a way to apply voltage bias to the device while still grounding the device and the bias source. Figure 14 shows a technique in which the desired bias is applied at the noninverting terminal thus forcing that voltage at the inverting terminal. The current is sensed by R_F , and the AD524 instrumentation amplifier converts the floating differential signal to a single-ended output.

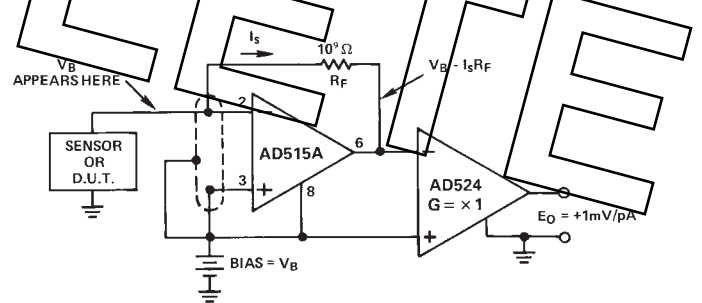

Figure 14. Current-to-Voltage Converters with Grounded Bias and Sensor

OUTLINE DIMENSIONS

Dimensions shown in inches and (mm).

TO-99

