

DIN W48×H24mm Small Digital Multi Panel Meter

■ Features

- Upgraded of **M4N Series**
- 1 power enables to supply the power to several M4NN units by insulating input and power part
- Display range : -1999 to 9999
- Power supply : 5-24VDC(insulation type)
- Preset output : OUT1, GO, OUT2(NPN/PNP open collector output)
- Power factor display and output: displays input of 1-5V, 4 to 20mA, etc as -0.5 to 1 to 0.5
- Various input types

DC voltage model : $\pm 200\text{mV}/\pm 1\text{V}/\pm 2\text{V}/\pm 10\text{V}/\pm 20\text{V}/\pm 100\text{V}/\pm 200\text{V}/\pm 600\text{V}$ /power factor

DC current model : $\pm 2\text{mA}/\pm 10\text{mA}/\pm 20\text{mA}/4 \text{ to } 20\text{mA}/\pm 100\text{mA}/\pm 200\text{mA}/\pm 1\text{A}/\pm 2\text{A}/\pm 5\text{A}$ /power factor

AC voltage model : 1V/2V/10V/20V/50V/110V/250V/600V/AC frequency

AC current model : 50mA/100mA/250mA/500mA/1A/2.5A/5A/AC frequency

⚠ Please read "Caution for your safety" in operation manual before using.



NEW



■ Ordering information

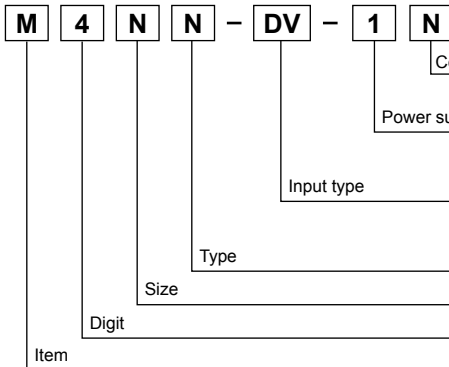

N	Indicator(without output function)
1	NPN Open Collector output
2	PNP Open Collector output
1	5-24VDC
DV	DC Volt(MINUS input)
DA	DC Ampere(MINUS input)
AV	AC Volt
AA	AC Ampere
N	New Type
N	DIN W48×H24mm
4	9999(4digit)
M	Multi Meter

■ Front panel identification

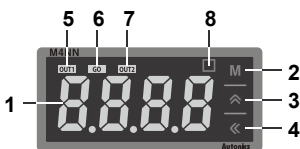

1. Measurement value display part
2. **M** : MODE key
3. **↑** : Up key
4. **↓** : Shift key
5. **OUT1(red)** : OUT1 output indicator of preset
6. **GO(green)** : GO output indicator of preset
7. **OUT2(red)** : OUT2 output indicator of preset
8. Unit sticker

■ Dimensions

● Bracket

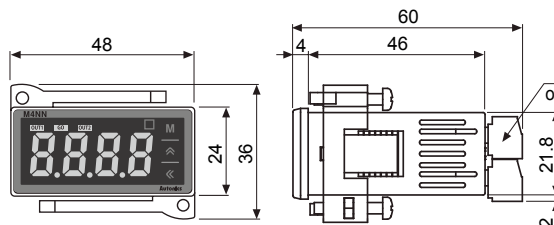
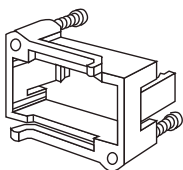

● Panel cut-out

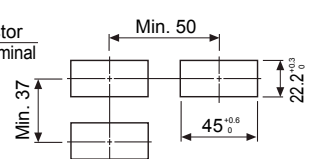

(unit : mm)

- (A) Photo electric sensor
- (B) Fiber optic sensor
- (C) Door/Area sensor
- (D) Proximity sensor
- (E) Pressure sensor
- (F) Rotary encoder
- (G) Connector/Socket
- (H) Temp. controller
- (I) SSR/Power controller
- (J) Counter
- (K) Timer
- (L) Panel meter**
- (M) Tacho/Speed/ Pulse meter
- (N) Display unit
- (O) Sensor controller
- (P) Switching mode power supply
- (Q) Stepper motor& Driver&Controller
- (R) Graphic/Logic panel
- (S) Field network device
- (T) Software
- (U) Other

M4NN Series

Specifications

Model	M4NN-DV-1□	M4NN-DA-1□	M4NN-AV-1□	M4NN-AA-1□
Input	DC voltage	DC current	AC voltage, frequency	AC current, frequency
Max. allowable input	-110% to 110% of the rated measurement input range (when not using MINUS input : -10% to 110%)		110% of the rated measurement input range	
Power supply	5-24 VDC			
Allowable voltage range	5-26.4VDC			
Power consumption	3W			
Display method	7 segment LED Display(red), character height: 11mm			
Display accuracy	•23°C±5°C-DC type : ±0.1% F.S. ±2digit / AC Type ±0.3% F.S. ±3digit ※For 5A terminal of M4NN-DA, AA type, within ±0.3% F.S. ±3digit •-10°C to 50°C-DC/AC type : ±0.5% F.S. ±3digit / Frequency : ±0.5% F.S. ±3digit ※For 5A terminal of M4NN-DA, AA type, ±1% F.S. ±3digit			
Display cycle	Setting displays cycle in RUN mode(selectable per 0.1 sec. within 0.1 to 5.0 sec.)			
A/D conversion method	Practical oversampling using successive approximation ADC			
Sampling cycle	50ms(resolution 1/12,000) 16.6ms(resolution 1/12,000)			
Max. display range	-1999 to 9999(4 digit)			
Preset output ^{※1}	NPN/PNP Open Collector output: 12-24VDC±2V 50mA Max.(resistance load)			
AC measurement ^{※2}	—		Average value (AVG) measurement	
Frequency measurement ^{※2}	—		Measurement range : 0.100 to 9999Hz(variable by decimal point position)	
Insulation resistance	Min. 100MΩ (at 500VDC megger)			
Dielectric strength	2,000VAC for 1 min.(between external terminals and case)			
Noise resistance	±2kV the square wave noise (pulse width: 1μs) by the noise simulator			
Vibration	Mechanical	0.75mm amplitude at frequency of 10 to 55Hz(for 1 min.) in each of X, Y, Z directions for 2 hours		
	Malfunction	0.5mm amplitude at frequency of 10 to 55Hz(for 1 min.) in each of X, Y, Z directions for 10 min.		
Shock	Mechanical	100m/s ² (approx. 10G) in each of X, Y, Z directions for 3 times		
	Malfunction	300m/s ² (approx. 30G) in each of X, Y, Z directions for 3 times		
Environment	Ambient temperature	-10 to 50°C, storage: -20 to 60°C		
	Ambient humidity	35 to 85%RH, storage: 35 to 85%RH		
Connection	Plug/Socket terminal block(accessory)			
Insulation type	Double insulation or reinforced insulation (mark: □, dielectric strength between the measured input part and the power part: 1kV)			
Unit weight	Approx. 28g			

※1. Indicator (M4NN-□□-1N) model does not have output function. ※2. AC, frequency measurement functions are only for AC measurement type.
 ※ Environment resistance is rated at no freezing or condensation.

Connections

M4NN-DV-1□

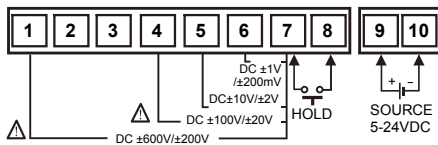

M4NN-DA-1□

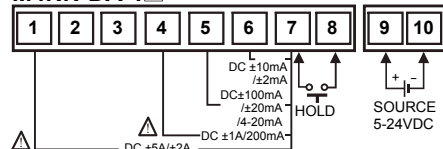

M4NN-AV-1□

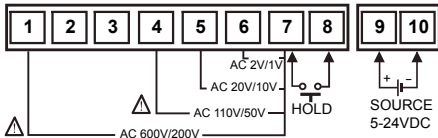

M4NN-AA-1□

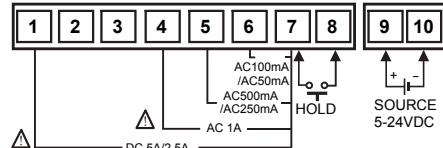

NPN Open Collector

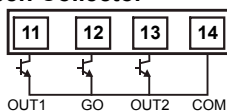

PNP Open Collector

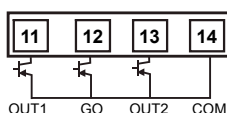

※Input and output are insulated from the power.

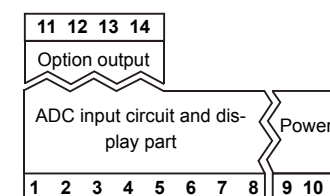

Small Multi Panel Meter

Parameter settings

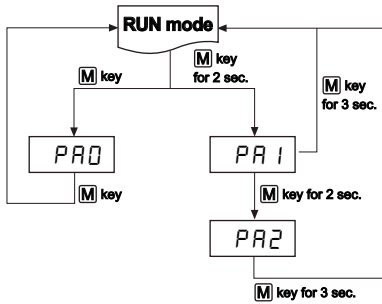

Parameter 1 group

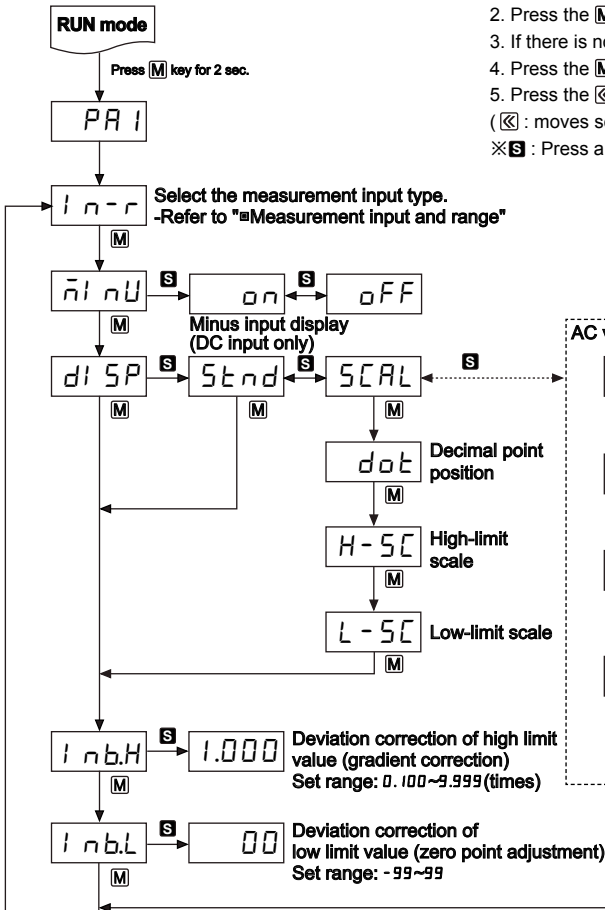

Parameter (0 to 2) group setting method

1. Each parameter alternately displays parameter name and the SV in 0.5 sec.
 2. Press the [M] key and the SV is saved and it moves to next parameter.
 3. If there is no operation for 60 sec., it returns to RUN mode automatically.
 4. Press the [M] keys for 3 sec. and it returns to RUN mode.
 5. Press the [←], [→] keys to change the SV at the parameter.
- (← : moves setting digit, → : changes S)
 ※S : Press any key between ←, →.

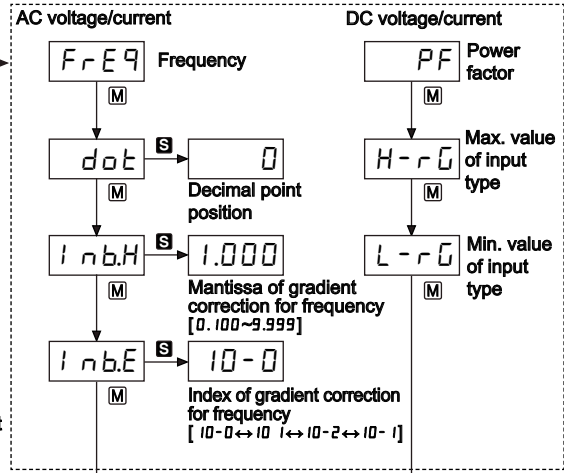

Factory default

Parameter	M4NN-DV	M4NN-DA	M4NN-AV	M4NN-AA	Parameter	M4NN-DV	M4NN-DA	M4NN-AV	M4NN-AA
in-r	600u	5A	600u	5A	Inb.H	1.000	1.000	1.000	1.000
nInU	on	on	—	—	Inb.L	0	0	0	0
dISP	Stnd	Stnd	Stnd	Stnd	H-rG	600	5.00	—	—
dot	0	0	0	0	L-rG	-600	-5.00	—	—
H-SC	600	500	600	5000	Inb.E	—	—	10-0	10-0
L-SC	-600	-500	0	0					

- (A) Photo electric sensor
- (B) Fiber optic sensor
- (C) Door/Area sensor
- (D) Proximity sensor
- (E) Pressure sensor
- (F) Rotary encoder
- (G) Connector/Socket
- (H) Temp. controller
- (I) SSR/Power controller
- (J) Counter
- (K) Timer
- (L) Panel meter
- (M) Tacho/Speed/Pulse meter
- (N) Display unit
- (O) Sensor controller
- (P) Switching mode power supply
- (Q) Stepper motor& Driver&Controller
- (R) Graphic/Logic panel
- (S) Field network device
- (T) Software
- (U) Other

M4NN Series

Parameter 2 group

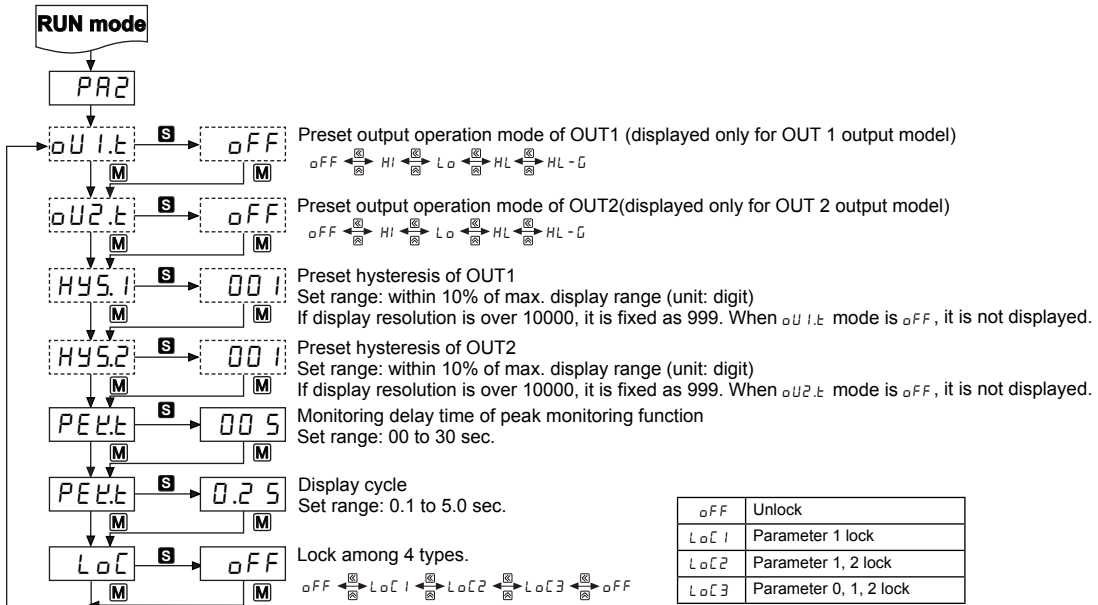

Factory default

Parameter	M4NN-DV	M4NN-DA	M4NN-AV	M4NN-AA	Parameter	M4NN-DV	M4NN-DA	M4NN-AV	M4NN-AA
oU1.t ^{*1}	oFF	oFF	oFF	oFF	PEEL	00 5	00 5	00 5	00 5
oU2.t ^{*1}	oFF	oFF	oFF	oFF	di 5t	0.2 5	0.2 5	0.2 5	0.2 5
HYS.1 ^{*1}	—	—	—	—	LoC	oFF	oFF	oFF	oFF
HYS.2 ^{*1}	—	—	—	—					

※It is not displayed for the indicator model.

Parameter 0 group

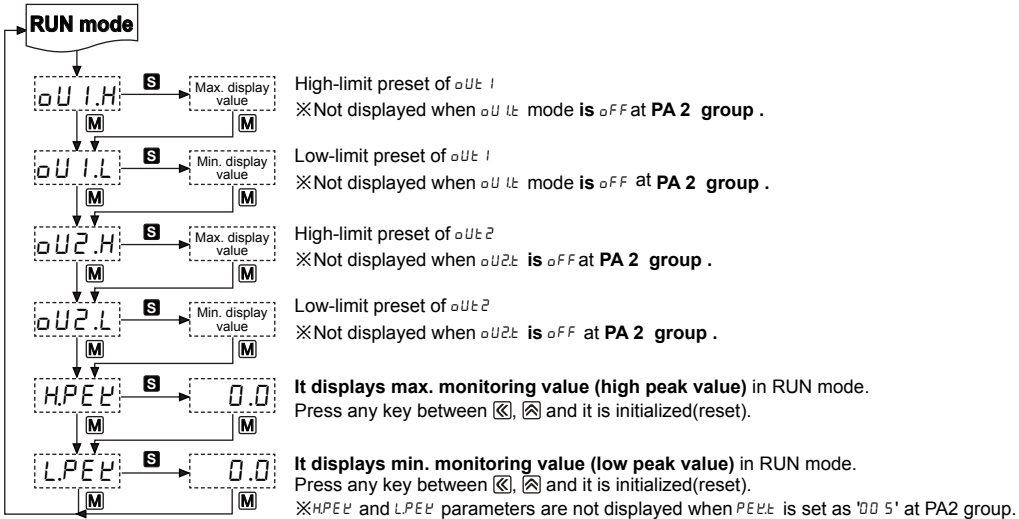

Factory default

Parameter	M4NN-DV	M4NN-DA	M4NN-AV	M4NN-AA	Parameter	M4NN-DV	M4NN-DA	M4NN-AV	M4NN-AA
oU1.H ^{*1}	600	5.00	600.0	5.000	oU2.L ^{*1}	-600	-5.00	000.0	0.000
oU1.L ^{*1}	-600	-5.00	000.0	0.000	HPEL ^{*1}	0	0.00	0.0	0.000
oU2.H ^{*1}	600	5.00	600.0	5.000	LPEL ^{*1}	0	0.00	0.0	0.000

※It is not displayed for the indicator model.

Small Multi Panel Meter

■ Specification of measurement input and range

Type	Measured input range	Input impedance	Display range [Scale]	Note
DC voltage	-600 to 600V [6000]	4.694MΩ	-600 to 600	※For DC input, not to display minus input, set minus input display [Function] of PA1 group as OFF. Ex) When the display range is -600 to 600V, set [Function] of PA1 group as OFF and this display range is 0 to 600V.
	-200 to 200V [2000]	4.694MΩ	-199.9 to 200.0	
	-100 to 100V [1000]	794kΩ	-100.0 to 100.0	
	-20 to 20V [200]	79kΩ	-19.99 to 20.00	
	-10 to 10V [100]	79kΩ	-10.00 to 10.00	
	-2 to 2V [20]	79kΩ	-1.999 to 2.000	
	-1 to 1V [10]	7.5kΩ	-1.000 to 1.000	
	-200 to 200mV [0.20]	7.5kΩ	-199.9 to 200.0	
DC current	-5 to 5A [5A]	0.01kΩ	-5.00 to 5.00	(display range depends on the decimal point position)
	-2 to 2A [2A]	0.01Ω	-1.999 to 2.000	
	-1 to 1A [1A]	0.1Ω	-1.000 to 1.000	
	-200 to 200mA [0.2A]	0.1Ω	-199.9 to 200.0	
	-100 to 100mA [0.1A]	1.1Ω	-100.0 to 100.0	
	-20 to 20mA [20mA]	1.1Ω	-19.99 to 20.00	
	4 to 20mA [4-20]	1.1Ω	4.00 to 20.00	
	-10 to 10mA [10mA]	11.1Ω	-10.00 to 10.00	
	-2 to 2mA [2mA]	11.1Ω	-1.999 to 2.000	
	AC voltage	0 to 600V [6000]	4.987MΩ	
0 to 250V [2500]		4.987MΩ	0.0 to 250.0	
0 to 110V [110P]		1.087MΩ	0.0 to 440.0	
0 to 50V [500]		1.087MΩ	0.00 to 50.00	
0 to 20V [200]		200kΩ	0.00 to 20.00	
0 to 10V [100]		200kΩ	0.00 to 10.00	
0 to 2V [20]		20kΩ	0.000 to 2.000	
0 to 1V [10]		20kΩ	0.000 to 1.000	
AC current	0 to 5A [5A]	0.01Ω	0.000 to 5.000	※For the range setting of AC voltage, when setting as 0 to 110V(110P) and using P.T for 440V/110VAC, 110V is input and 440V is displayed automatically by the set scale value for P.T users' convenience. ※Frequency measurement range (AC voltage/current) : 0.100 to 9999Hz
	0 to 2.5A [2.5A]	0.01Ω	0.000 to 2.500	
	0 to 1A [1A]	0.05Ω	0.000 to 1.000	
	0 to 500mA [0.5A]	0.1Ω	0.0 to 500.0	
	0 to 250mA [0.25A]	0.1Ω	0.0 to 250.0	
	0 to 100mA [0.1A]	0.5Ω	0.0 to 100.0	
	0 to 50mA [50mA]	0.5Ω	0.00 to 50.00	

- (A) Photo electric sensor
- (B) Fiber optic sensor
- (C) Door/Area sensor
- (D) Proximity sensor
- (E) Pressure sensor
- (F) Rotary encoder
- (G) Connector/Socket
- (H) Temp. controller
- (I) SSR/ Power controller
- (J) Counter
- (K) Timer
- (L) Panel meter
- (M) Tacho/ Speed/ Pulse meter
- (N) Display unit
- (O) Sensor controller
- (P) Switching mode power supply
- (Q) Stepper motor& Driver&Controller
- (R) Graphic/ Logic panel
- (S) Field network device
- (T) Software
- (U) Other

■ Functions

○ Minus input display [PA 1 group: $\bar{n}i nU$]

- When minus input is unnecessary, or when display "0" not to display minus input due to display minus input due to unstable input value around "0", set as OFF .
 - When setting as OFF , low-limit value of input range is set 0 and it displays minus input as 0.
 - The low-limit value of $L-SC$, $oUOL$, $L-rG$ parameters are changed based on "0".
Min. display value is "0" and $H-SC$, $H-rG$ parameters display max. value of the input range.
 $i nbH$ / $i nbL$ / $oUOL$ / HYS / $oUOH$ parameters are initialized to factory default.
- ※ In case of DC Ampere measurement input model, when $i nr$ (measurement input range) is set as $4-20$, this function is not displayed.

○ AC frequency measurement [PA 1 group: $dI SP$]

It measures input signal frequency when it is an AC input. It uses fixed decimal point [PA 1: dok], measured range can be changed by setting and measured range of decimal point position is as below chart. It is available to adjust upper gradient at [PA 1: $i nbH$] and [PA 1: $i nbE$]. In order to measure frequency normally, input signal, over 10% F.S. of the measured range, should be supplied. Please select the proper point of measurement terminal.

① Measurement range

Dot position	0.000	0.00	0.0	0
Measurement range	0.100 to 9.999Hz	0.10 to 99.99Hz	0.1 to 999.9Hz	1 to 9999Hz

※ Accuracy of frequency measurement: Below 1kHz, F.S. $\pm 0.1rdg \pm 2digit$, from 1kHz to 10kHz, F.S. $\pm 0.3rdg \pm 2digit$

- ② $i nbH$: 0.100 to 9.999 [gradient adjustment of high value]
- ③ $i nbE$: 10^{-2} , 10^{-1} , 10^0 , 10^1 [index adjustment of $i nbH$]

○ Zero adjustment [low-limit display value deviation correction]

This function is to forces the display value of measured input to 0 (Zero).

- Zero adjustment range: -99 to +99
- Zero adjustment method: Press the \boxplus keys for 3 sec.



When zero point adjustment with front key and hold terminal is finished normally, zero point of measurement terminal is displayed and the adjusted value is saved in $i nbL$ automatically.

※ If zero adjustment range is exceeded, the error (oUr) flashes twice and then move to RUN mode, maintaining previous setting value.

○ Initialization

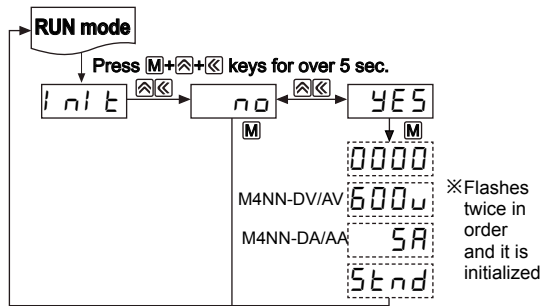

○ Error display

Display	Description
HHHH	Flashes when measured input is exceeded the max. allowable input (+110%)
LLLL	Flashes when measured input is exceeded the min. allowable input (MINUS input oN : -110% oFF : -10%)
d-HH	Flashes when display input is exceeded max. display range (9999)
d-LL	Flashes when display input is exceeded min. display range (-1999)
F-HH	Flashes when input frequency is exceeded the max. measured range (10kHz) and display range (9999)
PF-H	Flashes when power factor display value to measured input is over than LAG 0.50
PF-L	Flashes when power factor display value to measured input is less than LEAD -0.50

※ Error is cleared when the input value is within measurement range or display range.

○ Display cycle delay [PA 2 group: $dISt$]

In some applications the measured input may fluctuate which in turn causes the display to fluctuate. By adjusting the display cycle delay function time at $dISt$ of PA 2, the operator can adjust the display time within a range of 0.1 sec to 5 sec. For example, if the operator sets the display cycle time to 4.0 sec., the display value is displayed the averaged input value over 4 sec. in every 4 sec.

○ Monitoring max./min. display value [PA 0 group: $HPEL/LPEL$, PA 2 group: $PEEL$]

It monitors Max./Min. value of display value based on current display value and then display the data in $HPEL$, $LPEL$ of PA0. Set delay time (0 to 30 sec.) in $PEEL$ mode of parameter 2 in order to avoid caused by initial overcurrent or over voltage, when monitoring the peak value. Delay time is 0 to 30 sec. and it starts to monitor the peak value after set time.

When the \boxplus , \boxminus keys are pressed at $HPEL$, $LPEL$ mode of PA0, it will be initialized.

※ Monitoring function is not indicated when setting the of $PEEL$ PA 2 as "00 5".

◎ Error correction[PA 1 group: $i_{nb,H}$ / $i_{nb,L}$]

It corrects display value error of measurement input.
 $i_{nb,L}$: ± 99 [adjust deviation of low value],
 $i_{nb,H}$: 0.100 to 9.999 [correct gradient of high value]
 Display value=(measured value $\times i_{nb,H}$) + $i_{nb,L}$
 Ex) When the measured range is 0 to 500V, and the display range is 0 to 500.0. If the low display value is "1.2" to 0V input, set -12 as $i_{nb,L}$ value to display "0.0" by adjusting offset of the low value. The display value to 500V measured input varies by adjusting the offset of low value. If this display value is "501.0", calculate 500.0/501.0 (desired display value/the display value), and set the 0.998 correction value as the $i_{nb,H}$ to display 500.0 by adjusting gradient of high value.

※The offset correction range of $i_{nb,L}$ is within -99 to 99 for D⁰, D¹ digit regardless of $dot{dot}$.

※High limit error correction function is available as "Gradient correction function" and low limit error correction function is available as "Zero adjustment function".

◎ Gradient correction[PA 1 group: $i_{nb,H}$]

This function is to adjust gradient of standard display value or scale value for the input value within the measured input range. By adjusting gradient, it is available as "High limit error correction function".

As the below (figure 1), in case of display gradient 1 for the measured input 100V, this function is to adjust display value by adjusting the gradient as 1.5 times or 0.5 times.

• Set range : 0.100 to 9.999,

Factory default: 1,000(unit: times)

Ex1) Gradient adjustment

- ① When the measured input is 100.0V in order to display 150.0, set gradient correction set value($i_{nb,H}$) as 1,500. This value is also applied for minus input. When the measured input is -100.0V, it displays -150.0.
- ② When the measured input is -100.0V in order to display -050.0, set gradient correction set value($i_{nb,H}$) as 0.500. This value is also applied for plus input. When the measured input is 100.0V, it displays 50.0.

$i_{nb,H}$	Note
① 1.500	※Shaded part of Figure 1 is not displayed for the below cases • AC input model
② 0.500	• DC input model and Minus input[$\bar{n}nbU$] is set as $dot{dot}$ • DC current input model and Input range [i_{nr}] is set as 4-20

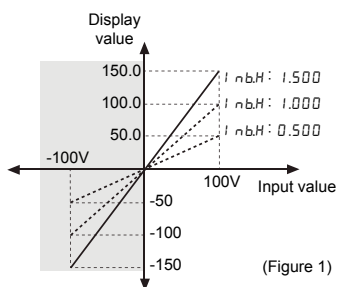

Ex2) Scale setting [$L - 5C$ / $H - 5C$] and gradient adjustment [$i_{nb,H}$](AC input)

- ① When the measured input AC 2.000V at the input range AC 0 to 5.000V and it displays 5.000, set decimal point position [$dot{dot}$] as 0.000 before setting the scale value.
- ② When the measured input is AC 2.000V in order to display 5.000, 12.500 should be displayed when max. input value is 5.000V. However, it cannot set because the max. set value is 9.999.
 Set as Gradient correction set value [$i_{nb,H}$] \times High scale value [$H - 5C$] = 12,500 as the following table.
- ③ After this setting is finished, it displays 5.000 when the measured input is 2.000V.

$H - 5C$	$L - 5C$	$i_{nb,H}$	Note
12.500	0.000	1.000	Unavailable to set because max. set value of $H - 5C$
6.250	0.000	2.000	In this case, any setting methods display the same display value.
3.125	0.000	4.000	
2.500	0.000	5.000	

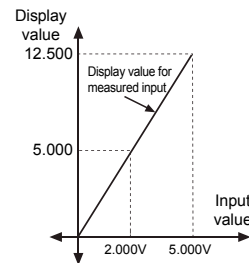

Ex3) Scale setting [$L - 5C$ / $H - 5C$] and gradient adjustment [$i_{nb,H}$](DC minus input)

- ① When the measured input DC -40mA at the input range DC -100.0 to 100.0mA and it displays -160.0, set decimal point position [$dot{dot}$] as 0.000 before setting the scale value.
- ② When the measured input is DC -40mA in order to display -160.0, -400.0 should be displayed when min. input value is -100.0mA. However, it cannot set because the min. set value is -199.9.
 Set as Gradient correction set value [$i_{nb,H}$] \times Low scale value [$L - 5C$] = -400.0 as the following table.
 Set high scale value as ($-L - 5C$) value. If high scale value is set at first, set low scale value as ($-H - 5C$) value.
- ③ After this setting is finished, it displays -160.0 when the measured input is DC -40.0mA.

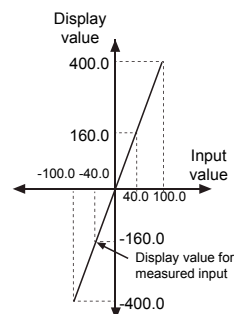

(A)	Photo electric sensor
(B)	Fiber optic sensor
(C)	Door/Area sensor
(D)	Proximity sensor
(E)	Pressure sensor
(F)	Rotary encoder
(G)	Connector/Socket
(H)	Temp. controller
(I)	SSR/ Power controller
(J)	Counter
(K)	Timer
(L)	Panel meter
(M)	Tacho/ Speed/ Pulse meter
(N)	Display unit
(O)	Sensor controller
(P)	Switching mode power supply
(Q)	Stepper motor & Driver & Controller
(R)	Graphic/ Logic panel
(S)	Field network device
(T)	Software
(U)	Other

M4NN Series

◎ Power factor (PF) display

[PA 1 group: H-rG / L-rG]

- ① This function displays LEAD and LAG by analog output signal from the power factor transducer.
- ② It is available to accept several outputs of the power factor transducer by max.(H-rG)/min.(L-rG) analog output value setting in the power factor transducer.
- ③ Power factor value is displayed as $\cos\theta$ value -0.50(LEAD) to 1.00 to 0.50(LAG).
- ④ LEAD is when current phase leads voltage phase, LAG is when current phase lags behind voltage phase. LEAD and LAG are invalid power.
- ⑤ Set range: From min. to max. selected value from measurement input(I-n-r)

Ex) When setting 200V in I-n-r, H-rG and L-rG are available to set from -199.9~200.0. When setting 10V, H-rG and L-rG are available to set from -10.00~10.00 (※H-rG > L-rG)

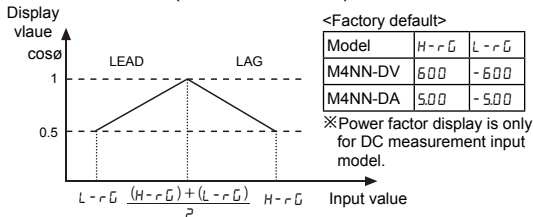

Ex1) When the output of the power factor transducer is DC 4-20mA,

- ① Connect the output to the input terminal 5(+), 7(-) of this unit, then set input range(I-n-r) as
- ② When setting the input range as 4-20, L-rG is set as 4.00 and H-rG is set as 20.00 automatically.
- ③ If measured input is 4mA, it displays -0.50. For 12mA measured input, it displays 1.00 and for 20mA, it displays 0.50.

Ex2) When the output of the power factor transducer is DC1-5V,

- ① Connect the output to the input terminal 5(+), 7(-) of this unit, then set the input range(I-n-r) as 10u.
- ② Select Minus input display function(̄i nU) as oFF not to display minus value.
- ③ Set H-rG as 5.00 and L-rG as 1.00 for the output of the power factor transducer.
- ④ If measured input is 1V, it displays -0.50. For 3V measured input, it displays 1.00 and for 5V, it displays 0.50.

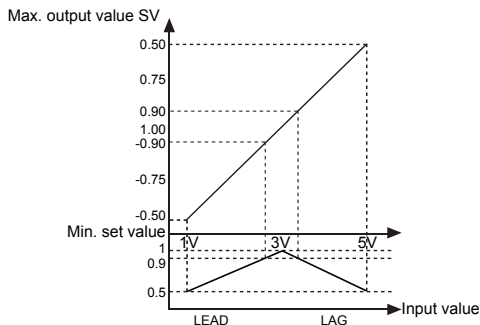

Ex3) When LEAD value is smaller than -0.90, LAG value is smaller than 0.90, and OUT1 is used,

- Set oU 1t as HL at PA2.
 - Set oU 1H as 0.90 and oU 1L as -0.90 at PA0.
- ※oU 2t is also same setting as oU 1t.

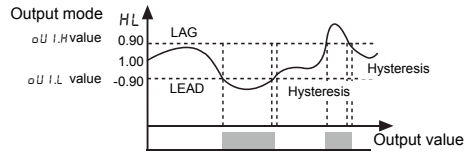

◎ Display scale function[PA 1 group: H-5C / L-5C]

This function is to display setting(-1999 to 9999) of particular High/Low-limit value in order to display High/Low-limit value of measurement input. If measurement inputs are 'a' and 'b' and particular values are 'A' and 'B', it will display a=A, b=B as below graphs.

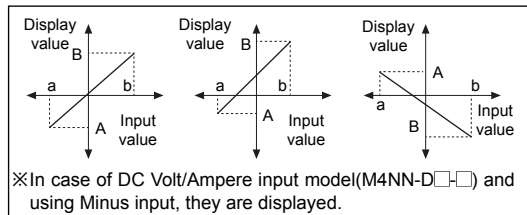
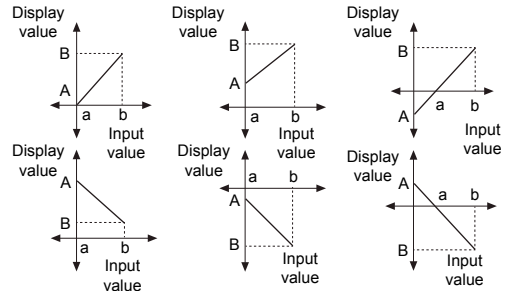

Display scale function is able to change display value for min./max. measured input by setting high limit scale[H-5C], and low limit scale[L-5C] in parameter 1 group.

Ex) High limit scale value and low limit scale value setting (In case of input range = 0V to 10V)

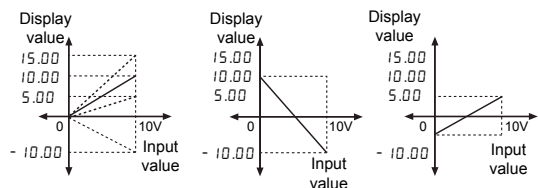

※When changing measured input, high limit scale value and low limit scale value are automatically changed as the default display range of the changed measured input.

◎ Preset output mode [PA 2 group: $\alpha U 1L / \alpha U 2L$]

Mode	Output mode	Operation
OFF		No output
HI		Period ON : Display value $\geq \alpha U 1.H$ Period OFF : Display value $\leq \alpha U 1.H - HYS.1$
Lo		Period ON : Display value $\leq \alpha U 1.L$ Period OFF : Display value $\geq \alpha U 1.L + HYS.1$
HL		Period ON : Display value $\leq \alpha U 1.L$ or Display value $\geq \alpha U 1.H$ Period OFF : Display value $\geq \alpha U 1.L + HYS.1$ or Display value $\leq \alpha U 1.H - HYS.1$
HL - G		Period ON : $OUT.L \leq$ Display value \leq $\alpha U 1.H + HYS.1$ Period OFF : Display value $\leq \alpha U 1.H - HYS.1$ or Display value $\geq \alpha U 1.H +$ $HYS.1$

- ※Set output mode separately for each OUT1/OUT2.
- ※OUT1/OUT2 are operated individually depending on output operation mode.
- ※Setting value mode of parameter group 0 is displayed depending on output operation mode.
- ※GO outputs when the period both OUT1/OUT2 are off.
(NPN/PNP Open collector output type)

(A)	Photo electric sensor
(B)	Fiber optic sensor
(C)	Door/Area sensor
(D)	Proximity sensor
(E)	Pressure sensor
(F)	Rotary encoder
(G)	Connector/ Socket
(H)	Temp. controller
(I)	SSR/ Power controller
(J)	Counter
(K)	Timer
(L)	Panel meter
(M)	Tacho/ Speed/ Pulse meter
(N)	Display unit
(O)	Sensor controller
(P)	Switching mode power supply
(Q)	Stepper motor& Driver&Controller
(R)	Graphic/ Logic panel
(S)	Field network device
(T)	Software
(U)	Other