

**SMPS MOSFET**

IRLR3715

IRLU3715

HEXFET® Power MOSFET

**Applications**

- High Frequency Isolated DC-DC Converters with Synchronous Rectification for Telecom and Industrial Use
- High Frequency Buck Converters for Computer Processor Power

**Benefits**

- Ultra-Low Gate Impedance
- Very Low  $R_{DS(on)}$  at 4.5V  $V_{GS}$
- Fully Characterized Avalanche Voltage and Current

$V_{DSS}$	$R_{DS(on)}$ max	$I_D$
20V	14m $\Omega$	54A

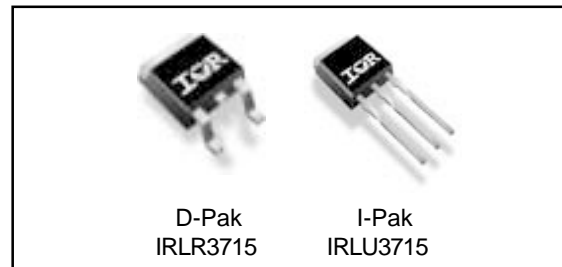

**Absolute Maximum Ratings**

Symbol	Parameter	Max.	Units
$V_{DS}$	Drain-Source Voltage	20	V
$V_{GS}$	Gate-to-Source Voltage	$\pm 20$	V
$I_D @ T_C = 25^\circ\text{C}$	Continuous Drain Current, $V_{GS} @ 10\text{V}$	54④	A
$I_D @ T_C = 100^\circ\text{C}$	Continuous Drain Current, $V_{GS} @ 10\text{V}$	38④	
$I_{DM}$	Pulsed Drain Current①	210	
$P_D @ T_C = 25^\circ\text{C}$	Maximum Power Dissipation	71	W
$P_D @ T_A = 25^\circ\text{C}$	Maximum Power Dissipation⑤	3.8	W
	Linear Derating Factor	0.48	W/ $^\circ\text{C}$
$T_J, T_{STG}$	Junction and Storage Temperature Range	-55 to + 175	$^\circ\text{C}$

**Thermal Resistance**

	Parameter	Typ.	Max.	Units
$R_{\theta JC}$	Junction-to-Case	—	2.1	$^\circ\text{C}/\text{W}$
$R_{\theta JA}$	Junction-to-Ambient	—	110	
$R_{\theta JA}$	Junction-to-Ambient (PCB mount)⑤	—	50	

Notes ① through ⑤ are on page 10

**Static @ T<sub>J</sub> = 25°C (unless otherwise specified)**

	Parameter	Min.	Typ.	Max.	Units	Conditions
V <sub>(BR)DSS</sub>	Drain-to-Source Breakdown Voltage	20	—	—	V	V <sub>GS</sub> = 0V, I <sub>D</sub> = 250μA
ΔV <sub>(BR)DSS/ΔT<sub>J</sub></sub>	Breakdown Voltage Temp. Coefficient	—	0.022	—	V/°C	Reference to 25°C, I <sub>D</sub> = 1mA
R <sub>DS(on)</sub>	Static Drain-to-Source On-Resistance	—	11	14	mΩ	V <sub>GS</sub> = 10V, I <sub>D</sub> = 26A ③
		—	15	20		V <sub>GS</sub> = 4.5V, I <sub>D</sub> = 21A ③
V <sub>GS(th)</sub>	Gate Threshold Voltage	1.0	—	3.0	V	V <sub>DS</sub> = V <sub>GS</sub> , I <sub>D</sub> = 250μA
I <sub>DSS</sub>	Drain-to-Source Leakage Current	—	—	20	μA	V <sub>DS</sub> = 16V, V <sub>GS</sub> = 0V
		—	—	100		V <sub>DS</sub> = 16V, V <sub>GS</sub> = 0V, T <sub>J</sub> = 125°C
I <sub>GSS</sub>	Gate-to-Source Forward Leakage	—	—	200	nA	V <sub>GS</sub> = 16V
	Gate-to-Source Reverse Leakage	—	—	-200		V <sub>GS</sub> = -16V

**Dynamic @ T<sub>J</sub> = 25°C (unless otherwise specified)**

Symbol	Parameter	Min.	Typ.	Max.	Units	Conditions
g <sub>fs</sub>	Forward Transconductance	26	—	—	S	V <sub>DS</sub> = 10V, I <sub>D</sub> = 21A
Q <sub>g</sub>	Total Gate Charge	—	11	17	nC	I <sub>D</sub> = 21A
Q <sub>gs</sub>	Gate-to-Source Charge	—	3.8	—		V <sub>DS</sub> = 10V
Q <sub>gd</sub>	Gate-to-Drain ("Miller") Charge	—	4.4	—		V <sub>GS</sub> = 4.5V
Q <sub>oss</sub>	Output Gate Charge	—	11	17		V <sub>GS</sub> = 0V, V <sub>DS</sub> = 10V
t <sub>d(on)</sub>	Turn-On Delay Time	—	6.4	—	ns	V <sub>DD</sub> = 10V
t <sub>r</sub>	Rise Time	—	73	—		I <sub>D</sub> = 21A
t <sub>d(off)</sub>	Turn-Off Delay Time	—	12	—		R <sub>G</sub> = 1.8Ω
t <sub>f</sub>	Fall Time	—	5.1	—		V <sub>GS</sub> = 4.5V ③
C <sub>iss</sub>	Input Capacitance	—	1060	—	pF	V <sub>GS</sub> = 0V
C <sub>oss</sub>	Output Capacitance	—	700	—		V <sub>DS</sub> = 10V
C <sub>rss</sub>	Reverse Transfer Capacitance	—	120	—		f = 1.0MHz

**Avalanche Characteristics**

Symbol	Parameter	Typ.	Max.	Units
E <sub>AS</sub>	Single Pulse Avalanche Energy②	—	110	mJ
I <sub>AR</sub>	Avalanche Current①	—	21	A

**Diode Characteristics**

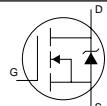
Symbol	Parameter	Min.	Typ.	Max.	Units	Conditions
I <sub>S</sub>	Continuous Source Current (Body Diode)	—	—	54④	A	MOSFET symbol showing the integral reverse p-n junction diode. 
I <sub>SM</sub>	Pulsed Source Current (Body Diode) ①	—	—	210		
V <sub>SD</sub>	Diode Forward Voltage	—	0.9	1.3	V	T <sub>J</sub> = 25°C, I <sub>S</sub> = 21A, V <sub>GS</sub> = 0V ③
		—	0.8	—		T <sub>J</sub> = 125°C, I <sub>S</sub> = 21A, V <sub>GS</sub> = 0V ③
t <sub>rr</sub>	Reverse Recovery Time	—	37	56	ns	T <sub>J</sub> = 25°C, I <sub>F</sub> = 21A, V <sub>R</sub> = 20V
Q <sub>rr</sub>	Reverse Recovery Charge	—	28	42	nC	di/dt = 100A/μs ③
t <sub>rr</sub>	Reverse Recovery Time	—	38	57	ns	T <sub>J</sub> = 125°C, I <sub>F</sub> = 21A, V <sub>R</sub> = 20V
Q <sub>rr</sub>	Reverse Recovery Charge	—	30	45	nC	di/dt = 100A/μs ③

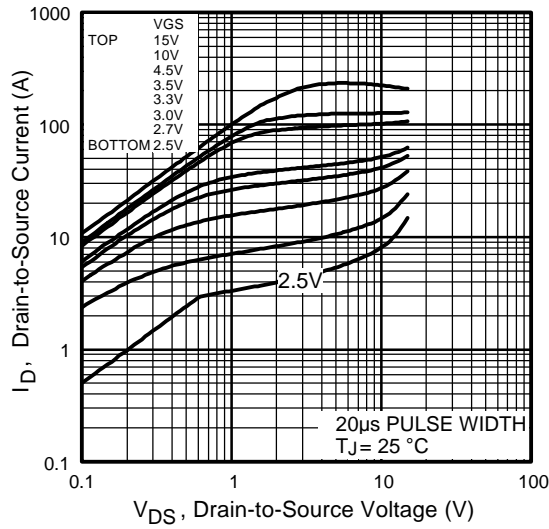

Fig 1. Typical Output Characteristics

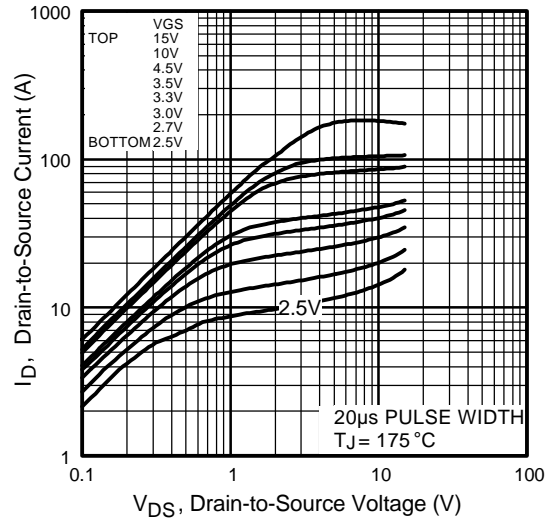

Fig 2. Typical Output Characteristics

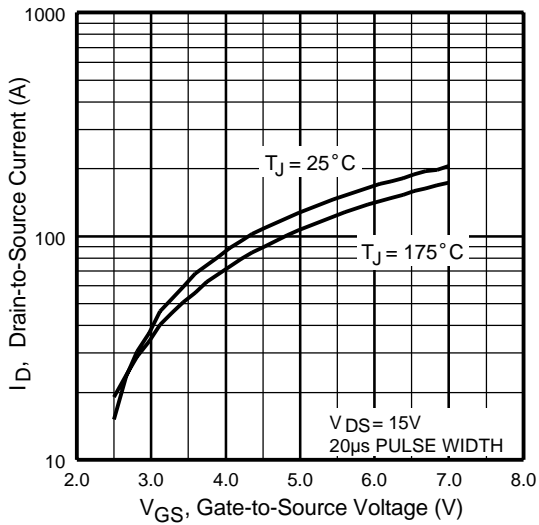

Fig 3. Typical Transfer Characteristics

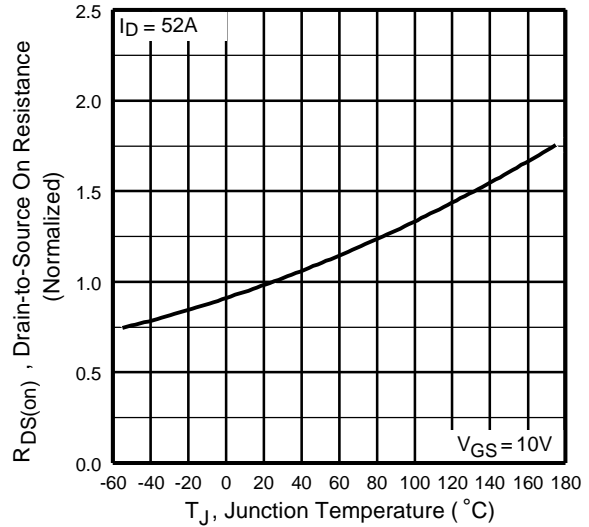
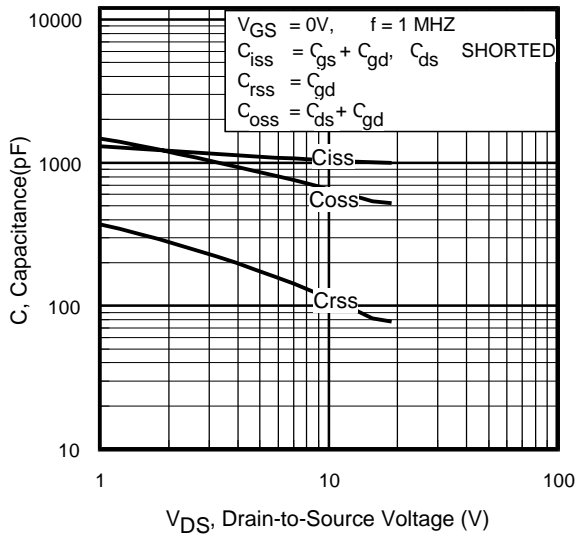
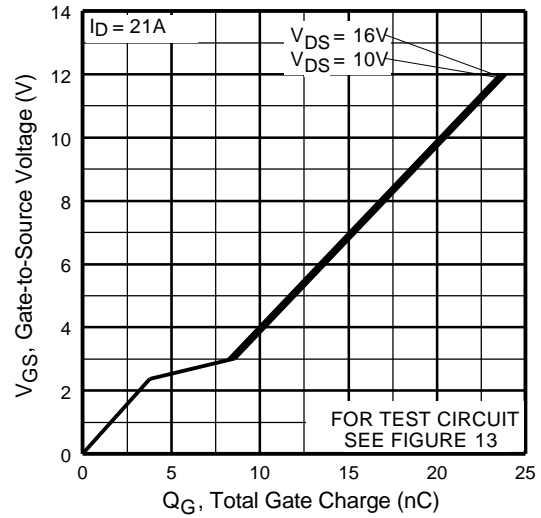

Fig 4. Normalized On-Resistance Vs. Temperature



**Fig 5.** Typical Capacitance Vs. Drain-to-Source Voltage



**Fig 6.** Typical Gate Charge Vs. Gate-to-Source Voltage

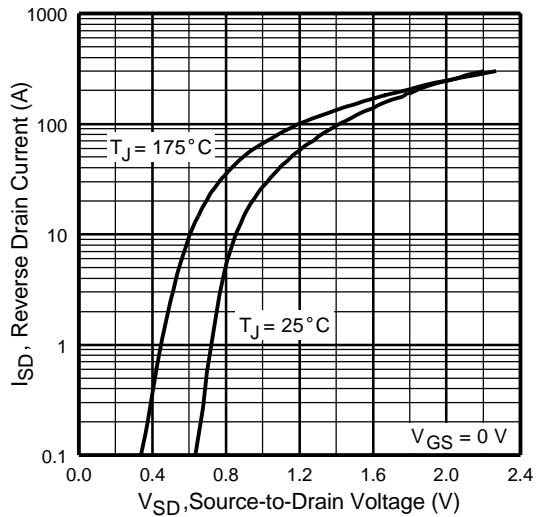

**Fig 7.** Typical Source-Drain Diode Forward Voltage

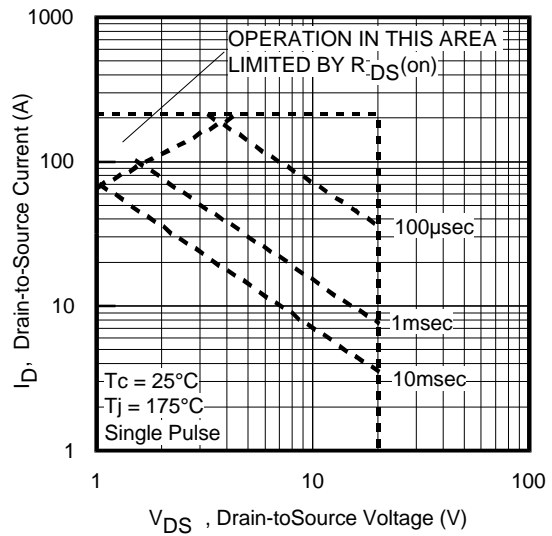

**Fig 8.** Maximum Safe Operating Area

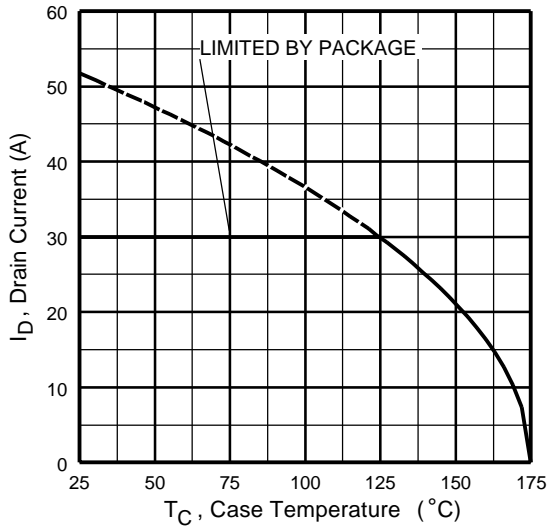

**Fig 9.** Maximum Drain Current Vs. Case Temperature

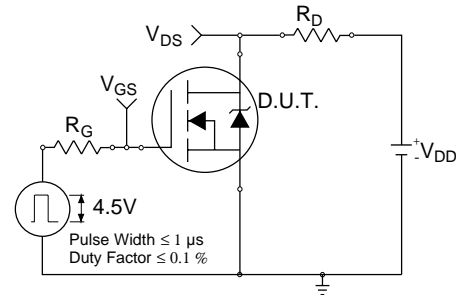

**Fig 10a.** Switching Time Test Circuit

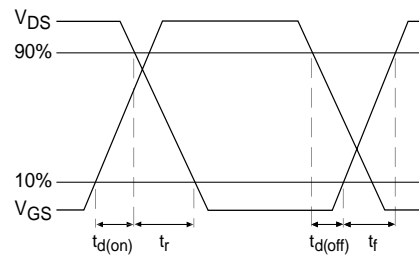

**Fig 10b.** Switching Time Waveforms

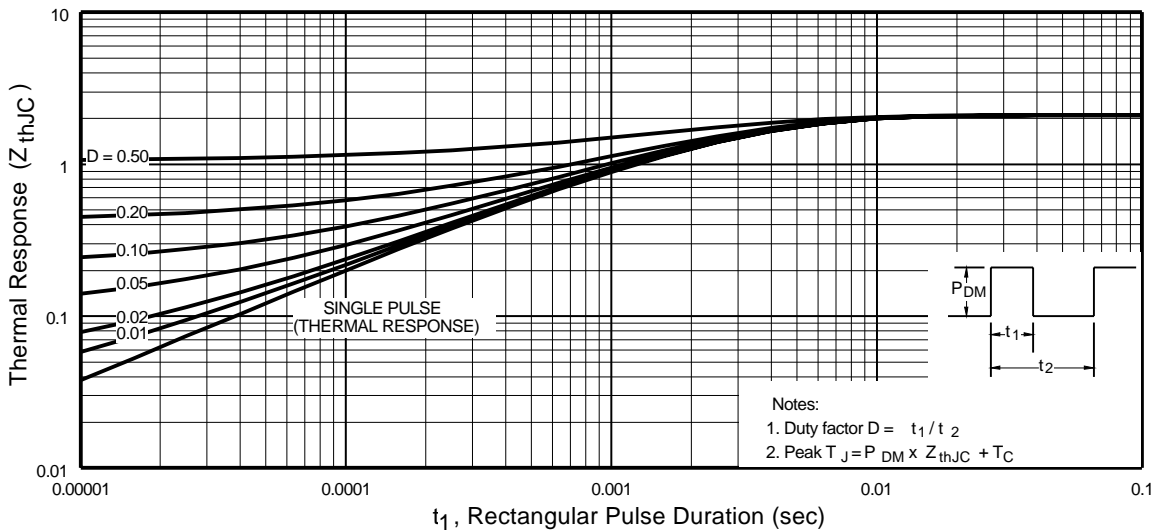

**Fig 11.** Maximum Effective Transient Thermal Impedance, Junction-to-Case

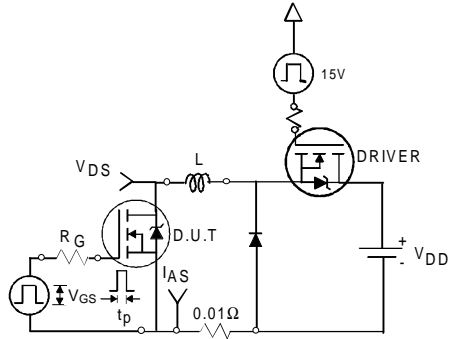

Fig 12a. Unclamped Inductive Test Circuit



Fig 12b. Unclamped Inductive Waveforms

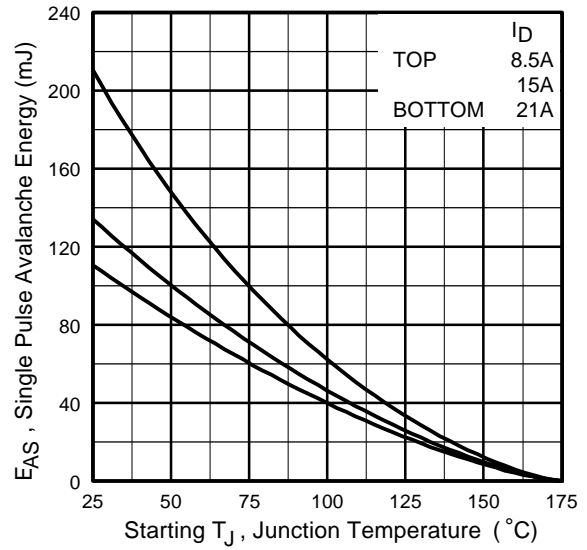

Fig 12c. Maximum Avalanche Energy Vs. Drain Current

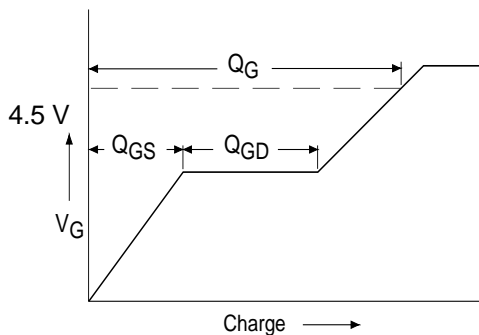

Fig 13a. Basic Gate Charge Waveform

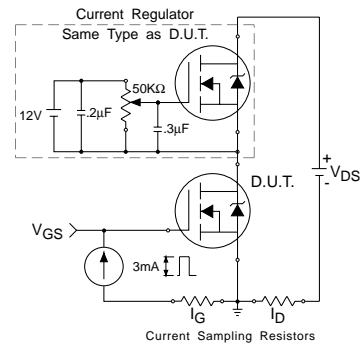
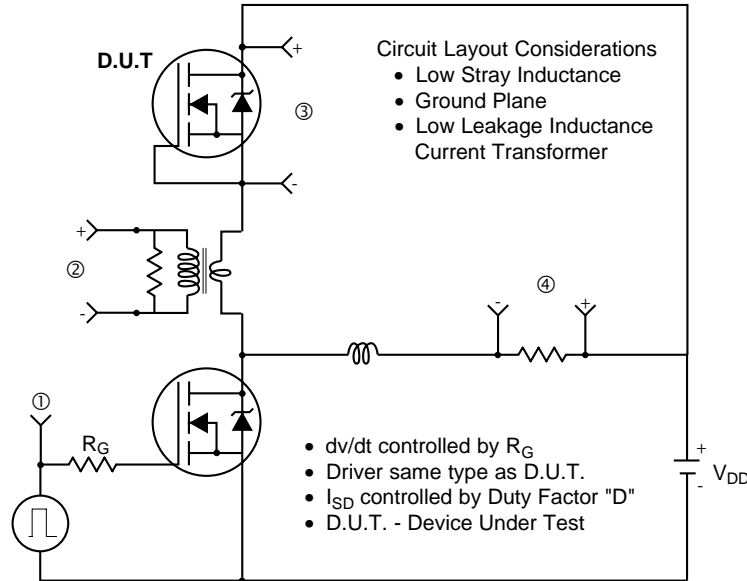

Fig 13b. Gate Charge Test Circuit

### Peak Diode Recovery dv/dt Test Circuit



\*  $V_{GS} = 5V$  for Logic Level Devices

**Fig 14.** For N-Channel HEXFET® Power MOSFETs

# IRLR/U3715

## D-Pak (TO-252AA) Package Outline

Dimensions are shown in millimeters (inches)

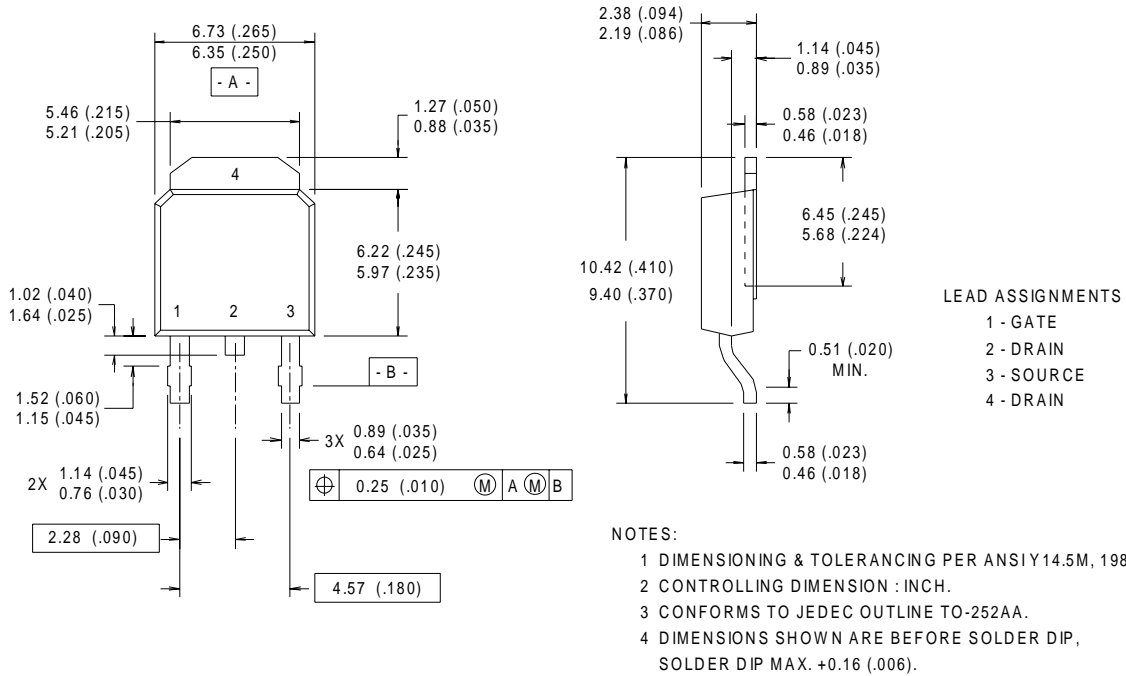

## D-Pak (TO-252AA) Part Marking Information

EXAMPLE: THIS IS AN IRFR120  
LOT CODE 1789  
ASSEMBLED ON WW 19, 1997  
IN THE ASSEMBLY LINE "C"

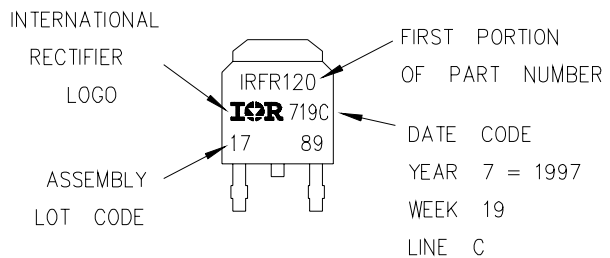



## I-Pak (TO-251AA) Package Outline

Dimensions are shown in millimeters (inches)

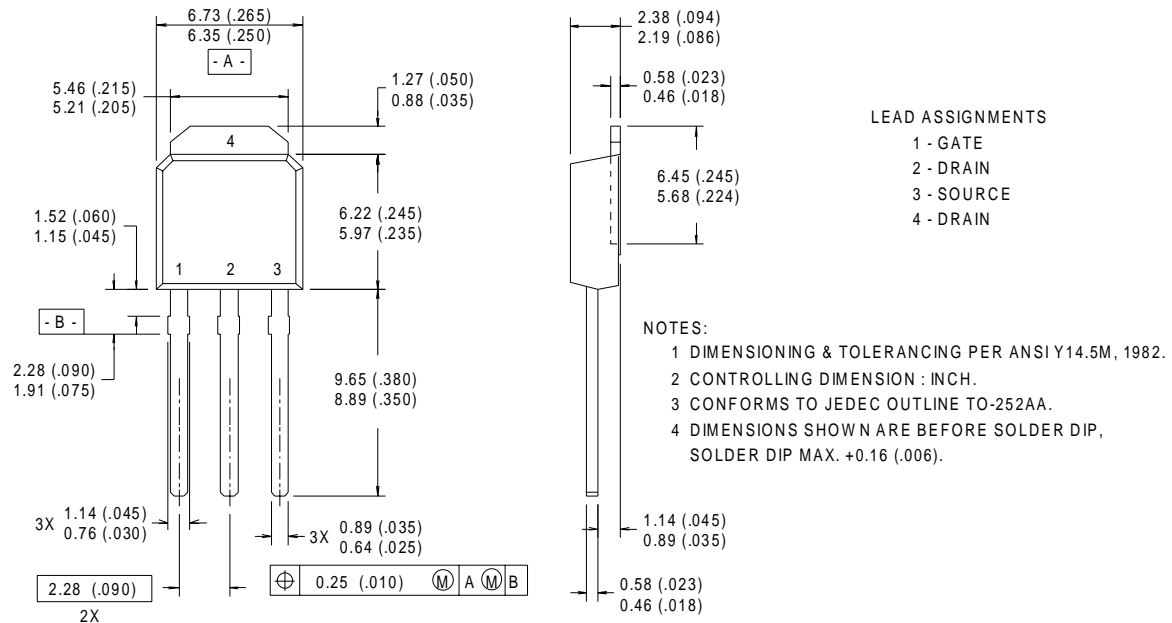

## I-Pak (TO-251AA) Part Marking Information

EXAMPLE: THIS IS AN IRFU120  
 LOT CODE 1789  
 ASSEMBLED ON WW 19, 1997  
 IN THE ASSEMBLY LINE "C"

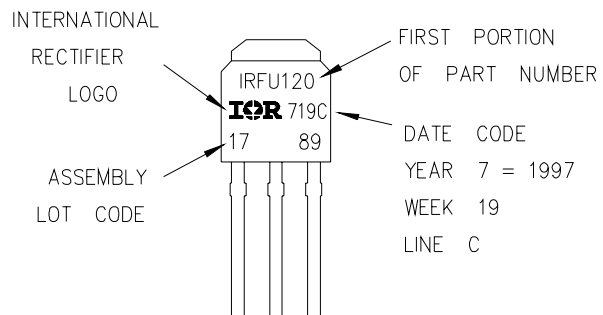

**D-Pak (TO-252AA) Tape & Reel Information**

Dimensions are shown in millimeters (inches)

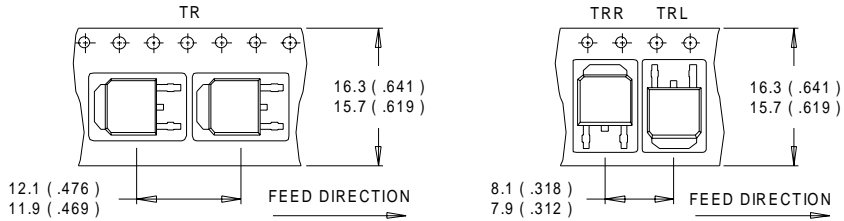

- NOTES :
1. CONTROLLING DIMENSION : MILLIMETER.
  2. ALL DIMENSIONS ARE SHOWN IN MILLIMETERS ( INCHES ).
  3. OUTLINE CONFORMS TO EIA-481 & EIA-541.

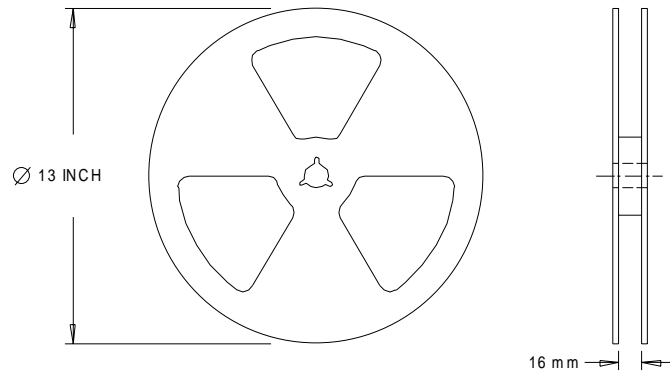

- NOTES :
1. OUTLINE CONFORMS TO EIA-481.

**Notes:**

- ① Repetitive rating; pulse width limited by max. junction temperature.
- ② Starting  $T_J = 25^\circ\text{C}$ ,  $L = 0.51\text{mH}$   
 $R_G = 25\Omega$ ,  $I_{AS} = 21\text{A}$ ,  $V_{GS} = 10\text{V}$
- ③ Pulse width  $\leq 400\mu\text{s}$ ; duty cycle  $\leq 2\%$ .
- ④ Calculated continuous current based on maximum allowable junction temperature. Package limitation current is 30A.
- ⑤ When mounted on 1" square PCB (FR-4 or G-10 Material) . For recommended footprint and soldering techniques refer to application note #AN-994

Data and specifications subject to change without notice.  
This product has been designed and qualified for the Industrial market.  
Qualification Standards can be found on IR's Web site.

Note: For the most current drawings please refer to the IR website at:  
<http://www.irf.com/package/>