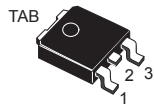
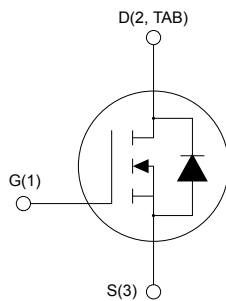

N-channel 60 V, 32 mΩ typ., 24 A, STripFET II Power MOSFET in a DPAK package

DPAK

AM01475v1_noZen

Features

Order code	V _{DS}	R _{DS(on)} max.	I _D	P _{TOT}
STD20NF06L	60 V	40 mΩ	24 A	60 W

- Exceptional dv/dt capability
- 100% avalanche tested
- Low gate charge

Applications

- Switching applications

Description

This Power MOSFET has been developed using STMicroelectronics' unique STripFET process, which is specifically designed to minimize input capacitance and gate charge. This renders the device suitable for use as primary switch in advanced high-efficiency isolated DC-DC converters for telecom and computer applications, and applications with low gate charge driving requirements.



Product status link

[STD20NF06L](#)

Product summary

Order code	STD20NF06LT4
Marking	D20NF06L
Package	DPAK
Packing	Tape and reel

1 Electrical ratings

Table 1. Absolute maximum ratings

Symbol	Parameter	Value	Unit
V_{DS}	Drain-source voltage	60	V
V_{GS}	Gate-source voltage	± 18	V
I_D	Drain current (continuous) at $T_C = 25\text{ }^\circ\text{C}$	24	A
	Drain current (continuous) at $T_C = 100\text{ }^\circ\text{C}$	17	
$I_{DM}^{(1)}$	Drain current (pulsed)	96	A
P_{TOT}	Total power dissipation at $T_C = 25\text{ }^\circ\text{C}$	60	W
	Derating factor	0.4	W/ $^\circ\text{C}$
$dv/dt^{(2)}$	Peak diode recovery voltage slope	10	V/ns
$E_{AS}^{(3)}$	Single pulse avalanche energy	225	mJ
T_{stg}	Storage temperature range	-55 to 175	$^\circ\text{C}$
T_J	Operating junction temperature range		

1. Pulse width is limited by safe operating area.
2. $I_{SD} \leq 24\text{ A}$, $di/dt \leq 300\text{ A/ns}$, $V_{DD} = 80\% V_{(BR)DSS}$
3. Starting $T_J = 25\text{ }^\circ\text{C}$, $I_D = I_{AR}\text{ A}$, $V_{DD} = 45\text{ V}$.

Table 2. Thermal data

Symbol	Parameter	Value	Unit
R_{thJC}	Thermal resistance, junction-to-case	2.5	$^\circ\text{C/W}$
$R_{thJB}^{(1)}$	Thermal resistance, junction-to-board	50	

1. When mounted on a 1-inch² FR-4, 2 Oz copper board.

2 Electrical characteristics

($T_C = 25\text{ °C}$ unless otherwise specified).

Table 3. Static

Symbol	Parameter	Test conditions	Min.	Typ.	Max.	Unit
$V_{(BR)DSS}$	Drain-source breakdown voltage	$V_{GS} = 0\text{ V}$, $I_D = 250\text{ }\mu\text{A}$	60			V
I_{DSS}	Zero gate voltage drain current	$V_{GS} = 0\text{ V}$, $V_{DS} = 60\text{ V}$			1	μA
		$V_{GS} = 0\text{ V}$, $V_{DS} = 60\text{ V}$, $T_C = 125\text{ °C}^{(1)}$			10	
I_{GSS}	Gate-body leakage current	$V_{DS} = 0\text{ V}$, $V_{GS} = \pm 18\text{ V}$			± 100	nA
$V_{GS(th)}$	Gate threshold voltage	$V_{DS} = V_{GS}$, $I_D = 250\text{ }\mu\text{A}$	1		2.5	V
$R_{DS(on)}$	Static drain-source on-resistance	$V_{GS} = 10\text{ V}$, $I_D = 12\text{ A}$		32	40	m Ω
		$V_{GS} = 5\text{ V}$, $I_D = 12\text{ A}$			50	

1. Defined by design, not subject to production test.

Table 4. Dynamic

Symbol	Parameter	Test conditions	Min.	Typ.	Max.	Unit
g_{fs}	Forward transconductance	$V_{DS} = 25\text{ V}$, $I_D = 12\text{ A}$	-	20	-	S
C_{iss}	Input capacitance	$V_{DS} = 25\text{ V}$, $f = 1\text{ MHz}$, $V_{GS} = 0\text{ V}$	-	660	-	pF
C_{oss}	Output capacitance		-	170	-	pF
C_{riss}	Reverse transfer capacitance		-	70	-	pF
$t_{d(on)}$	Turn-on delay time		-	11	-	ns
t_r	Rise time	$V_{DD} = 30\text{ V}$, $I_D = 10\text{ A}$, $R_G = 4.7\text{ }\Omega$, $V_{GS} = 10\text{ V}$ (see Figure 11. Test circuit for resistive load switching times)	-	50	-	ns
$t_{d(off)}$	Turn-off delay time		-	20	-	ns
t_f	Fall time		-	12	-	ns
Q_g	Total gate charge	$V_{DD} = 30\text{ V}$, $I_D = 20\text{ A}$, $V_{GS} = 10\text{ V}$, $R_G = 4.7\text{ }\Omega$ (see Figure 12. Test circuit for gate charge behavior)	-	13	-	nC
Q_{gs}	Gate-source charge		-	3.5	-	nC
Q_{gd}	Gate-drain charge		-	8	-	nC

Table 5. Source-drain diode

Symbol	Parameter	Test conditions	Min.	Typ.	Max.	Unit
I_{SD}	Source-drain current		-		24	A
$I_{SDM}^{(1)}$	Source-drain current (pulsed)		-		96	A
$V_{SD}^{(2)}$	Forward on voltage	$V_{GS} = 0\text{ V}$, $I_{SD} = 20\text{ A}$	-		1.5	V
t_{rr}	Reverse recovery time	$I_{SD} = 20\text{ A}$, $di/dt = 100\text{ A}/\mu\text{s}$, $V_{DD} = 20\text{ V}$, $T_J = 150\text{ °C}$ (see Figure 13. Test circuit for inductive load switching and diode recovery times)	-	56		ns
Q_{rr}	Reverse recovery charge		-	108		nC
I_{RRM}	Reverse recovery current		-	4		A

1. Pulse width is limited by safe operating area.
2. Pulse test: pulse duration = 300 μs , duty cycle 1.5%.

2.1 Electrical characteristics (curves)

Figure 1. Safe operating area

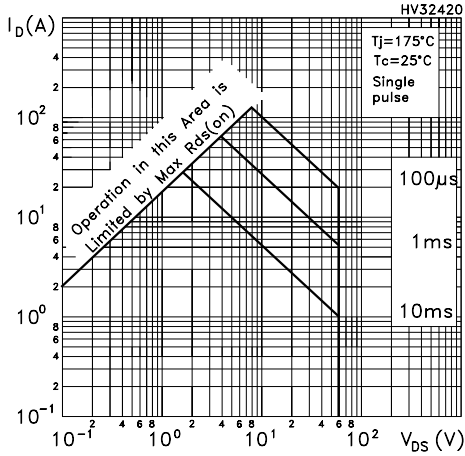

Figure 2. Thermal impedance

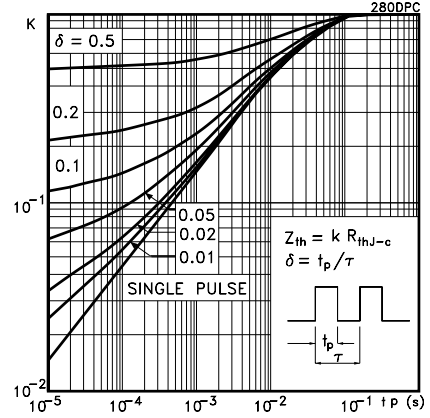

Figure 3. Output characteristics

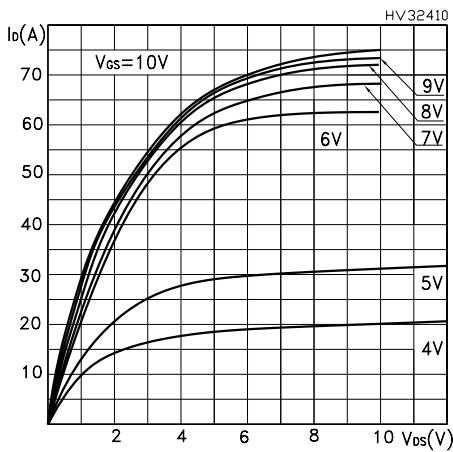

Figure 4. Transfer characteristics

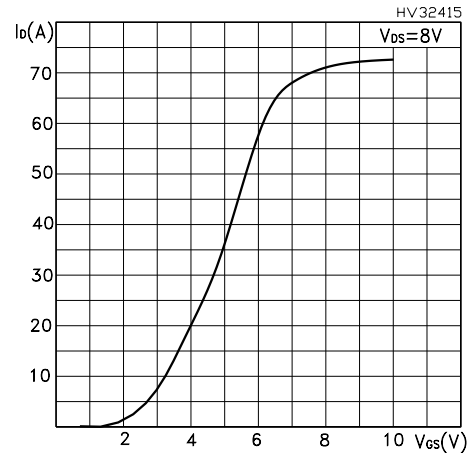

Figure 5. Static drain-source on-resistance

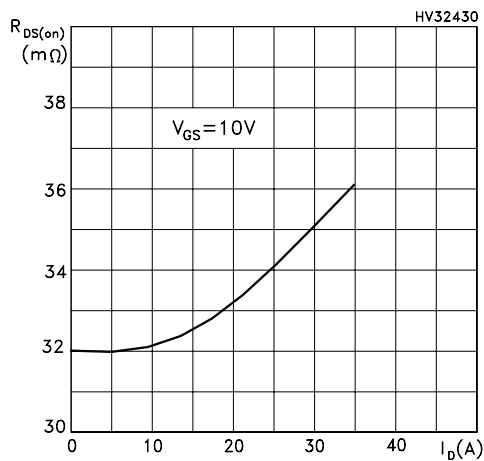

Figure 6. Gate charge vs gate-source voltage

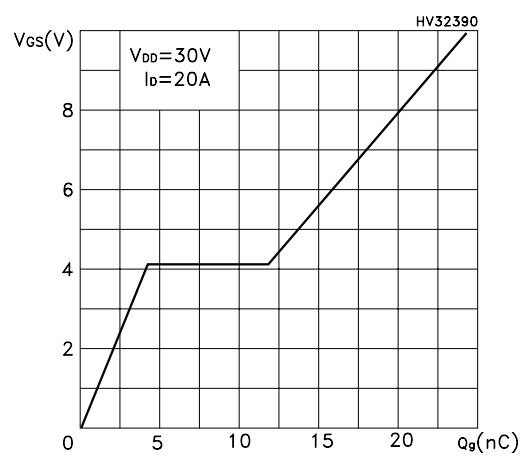

Figure 7. Capacitance variations

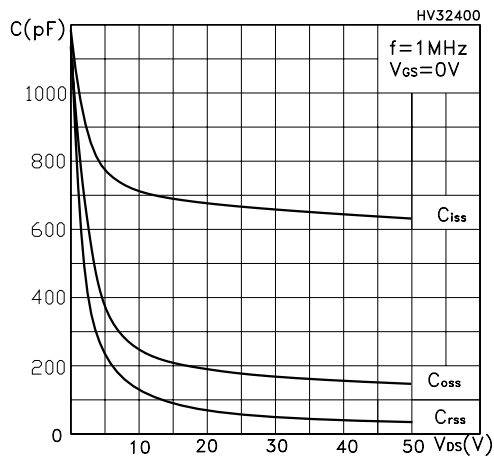

Figure 8. Normalized gate threshold voltage vs temperature

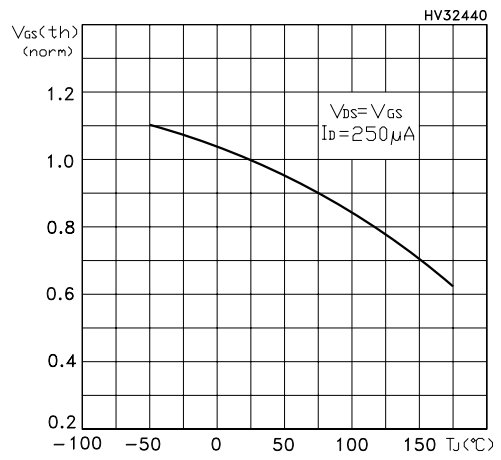

Figure 9. Normalized on-resistance vs temperature

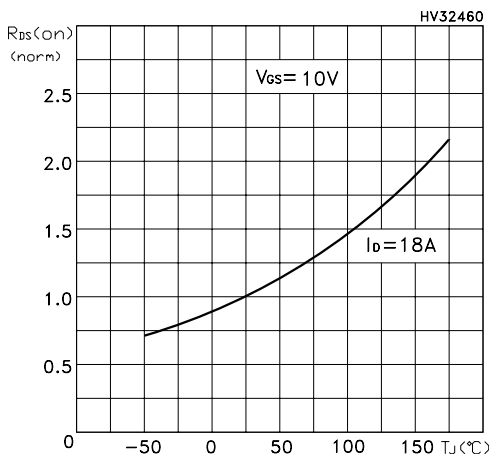
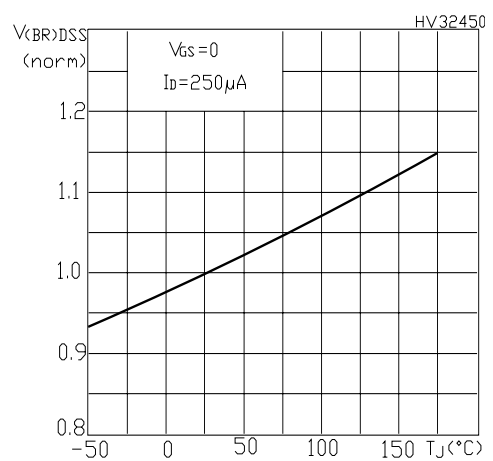
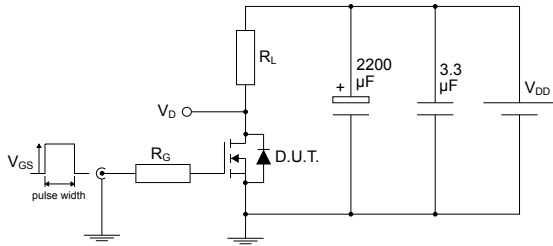

Figure 10. Normalized $V_{(BR)DSS}$ vs temperature



3 Test circuits

Figure 11. Test circuit for resistive load switching times

AM01468v1

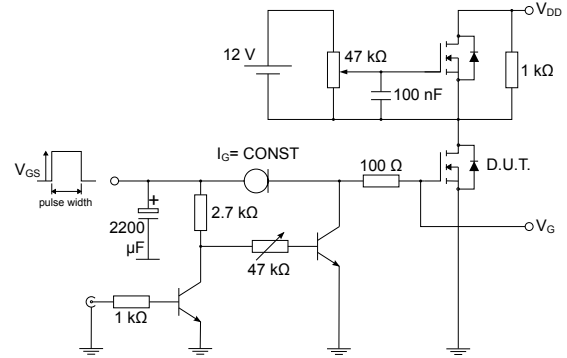
Figure 12. Test circuit for gate charge behavior

AM01469v1

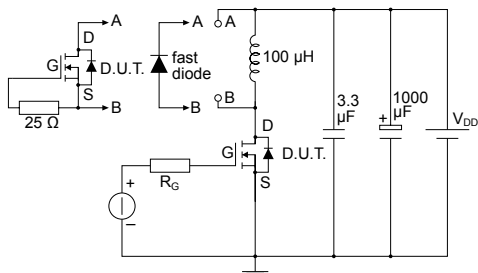
Figure 13. Test circuit for inductive load switching and diode recovery times

AM01470v1

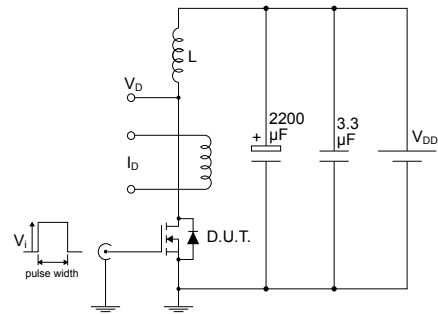
Figure 14. Unclamped inductive load test circuit

AM01471v1

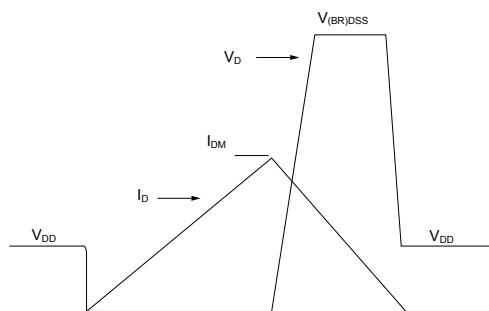
Figure 15. Unclamped inductive waveform

AM01472v1

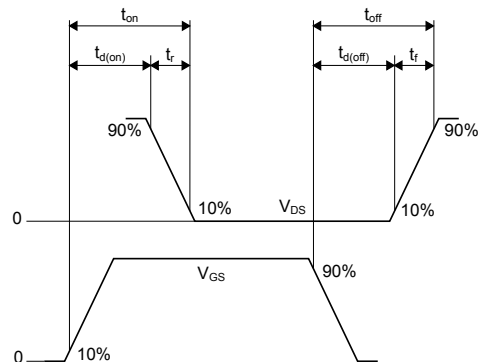
Figure 16. Switching time waveform

AM01473v1

4 Package information

In order to meet environmental requirements, ST offers these devices in different grades of **ECOPACK** packages, depending on their level of environmental compliance. ECOPACK specifications, grade definitions and product status are available at: www.st.com. ECOPACK is an ST trademark.

4.1 DPAK (TO-252) package information

Figure 17. DPAK (TO-252) type A package outline

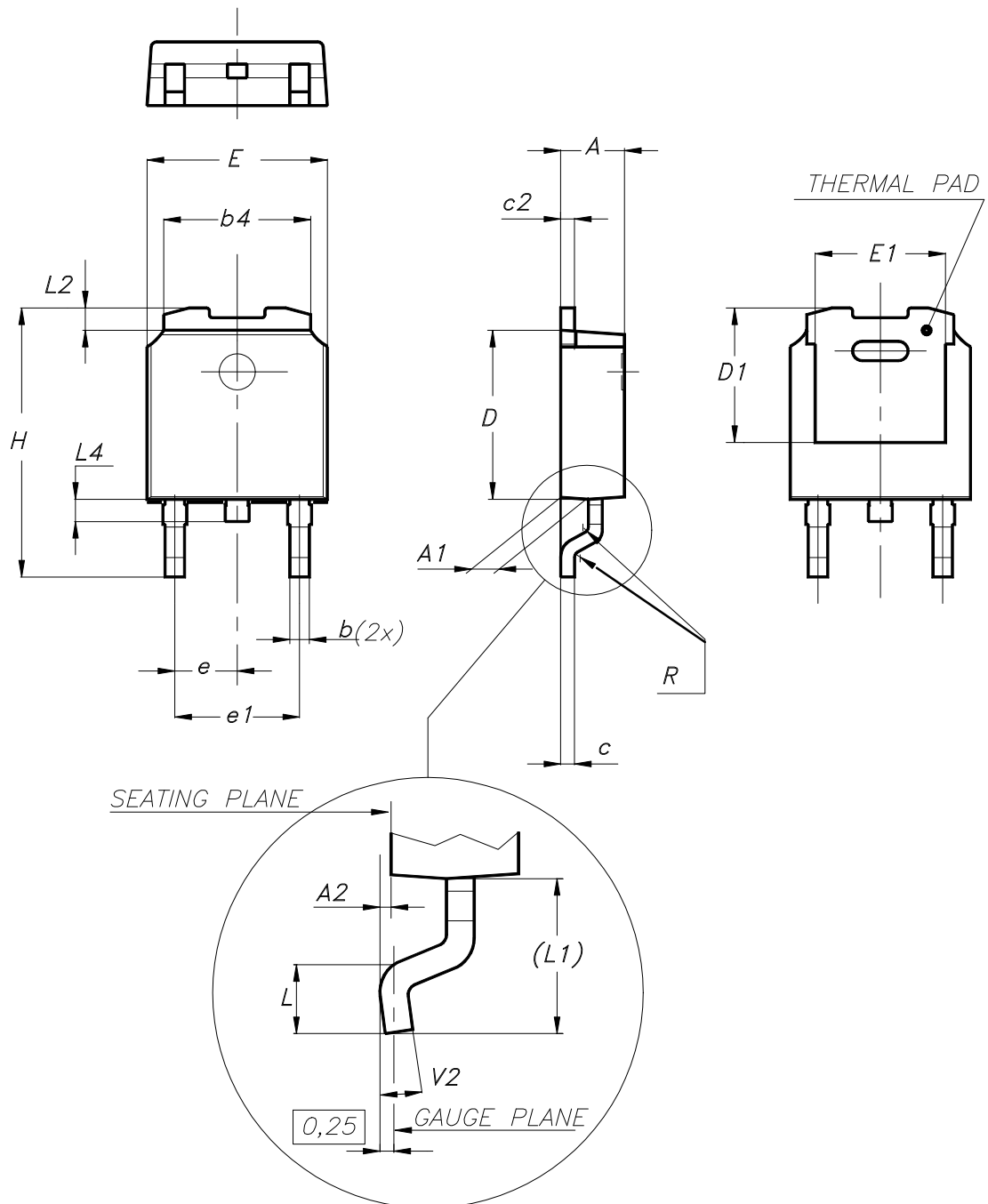
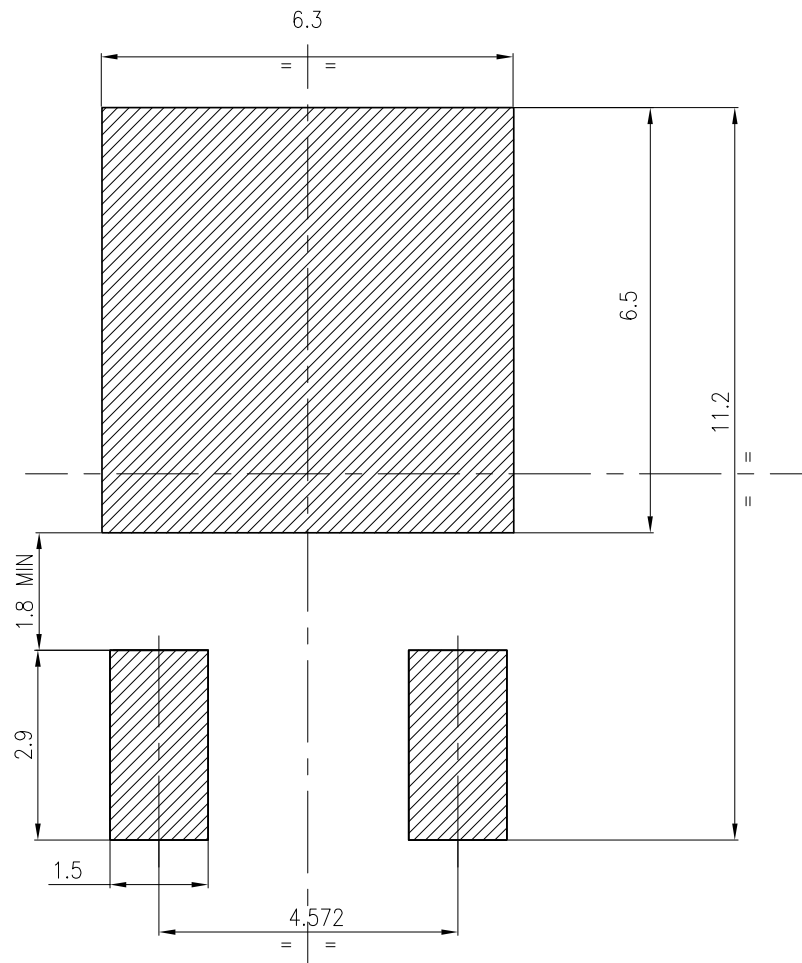

Table 6. DPAK (TO-252) type A mechanical data

Dim.	mm		
	Min.	Typ.	Max.
A	2.20		2.40
A1	0.90		1.10
A2	0.03		0.23
b	0.64		0.90
b4	5.20		5.40
c	0.45		0.60
c2	0.48		0.60
D	6.00		6.20
D1	4.95	5.10	5.25
E	6.40		6.60
E1	4.60	4.70	4.80
e	2.159	2.286	2.413
e1	4.445	4.572	4.699
H	9.35		10.10
L	1.00		1.50
(L1)	2.60	2.80	3.00
L2	0.65	0.80	0.95
L4	0.60		1.00
R		0.20	
V2	0°		8°

Figure 18. DPAK (TO-252) recommended footprint (dimensions are in mm)



FP_0068772_31

4.2 DPAK (TO-252) packing information

Figure 19. DPAK (TO-252) tape outline

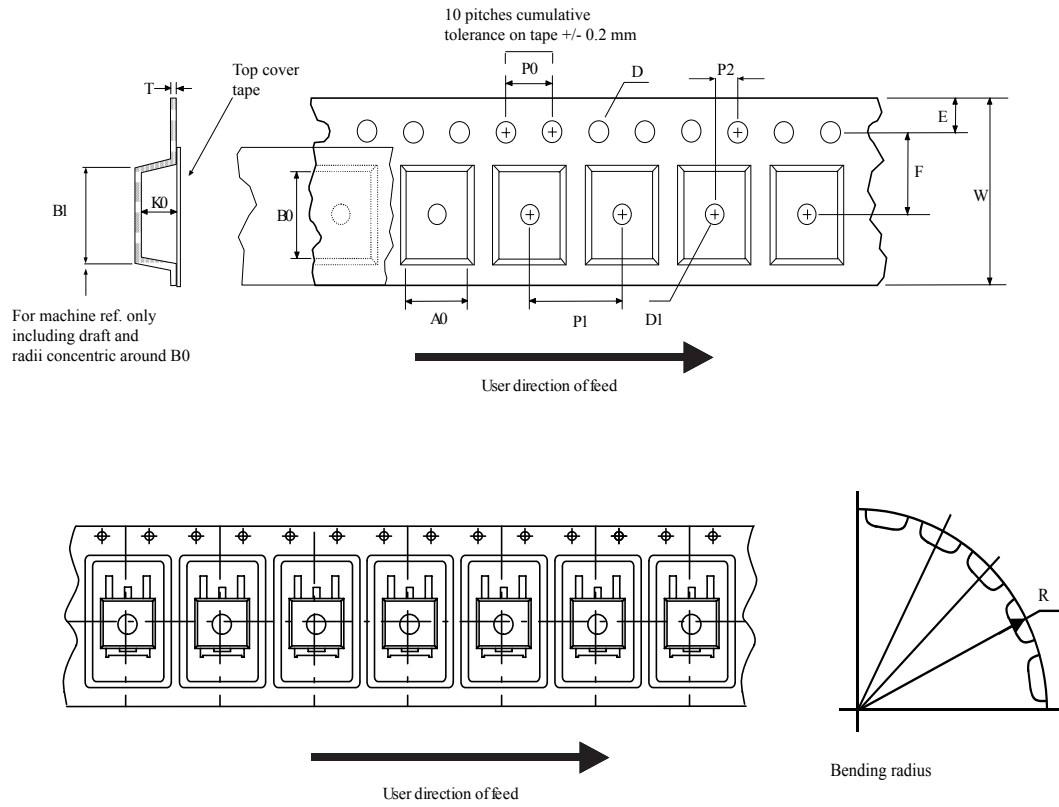

AM08852v1

Figure 20. DPAK (TO-252) reel outline

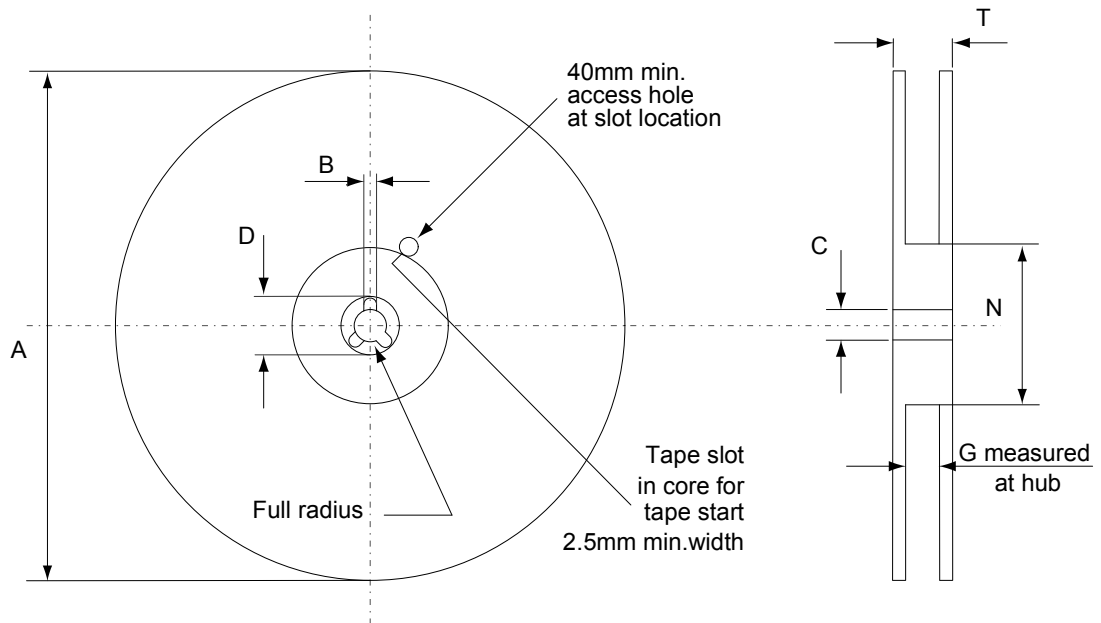

AM06038v1

Table 7. DPAK (TO-252) tape and reel mechanical data

Tape			Reel		
Dim.	mm		Dim.	mm	
	Min.	Max.		Min.	Max.
A0	6.8	7	A		330
B0	10.4	10.6	B	1.5	
B1		12.1	C	12.8	13.2
D	1.5	1.6	D	20.2	
D1	1.5		G	16.4	18.4
E	1.65	1.85	N	50	
F	7.4	7.6	T		22.4
K0	2.55	2.75			
P0	3.9	4.1		Base qty.	2500
P1	7.9	8.1		Bulk qty.	2500
P2	1.9	2.1			
R	40				
T	0.25	0.35			
W	15.7	16.3			

Revision history

Table 8. Document revision history

Date	Revision	Changes
19-Apr-2005	2	Added package IPAK
08-Jun-2006	3	Graphical updates
03-Jul-2006	4	New template, no content change
29-Apr-2022	5	The part number STD20NF06L-1 has been removed and the document has been updated accordingly.

Contents

1	Electrical ratings	2
2	Electrical characteristics	3
2.1	Electrical characteristics (curves)	5
3	Test circuits	7
4	Package information	8
4.1	DPAK (TO-252) package information	8
4.2	DPAK (TO-252) packing information	11
	Revision history	13

IMPORTANT NOTICE – READ CAREFULLY

STMicroelectronics NV and its subsidiaries (“ST”) reserve the right to make changes, corrections, enhancements, modifications, and improvements to ST products and/or to this document at any time without notice. Purchasers should obtain the latest relevant information on ST products before placing orders. ST products are sold pursuant to ST’s terms and conditions of sale in place at the time of order acknowledgment.

Purchasers are solely responsible for the choice, selection, and use of ST products and ST assumes no liability for application assistance or the design of purchasers’ products.

No license, express or implied, to any intellectual property right is granted by ST herein.

Resale of ST products with provisions different from the information set forth herein shall void any warranty granted by ST for such product.

ST and the ST logo are trademarks of ST. For additional information about ST trademarks, refer to www.st.com/trademarks. All other product or service names are the property of their respective owners.

Information in this document supersedes and replaces information previously supplied in any prior versions of this document.

© 2022 STMicroelectronics – All rights reserved