

PC Mount Relays

R25 Series



Features

- Epoxy Sealed for Wave Soldering & Cleaning
- Upright Package Type
- Suitable for 5mm Grid Pattern
- Immersion Proof



SPST-NO, 1 Form "A"

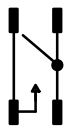

SPDT, 1 Form "C"

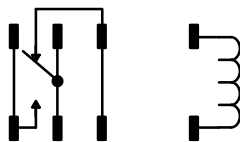

DPDT, 2 Form "C"

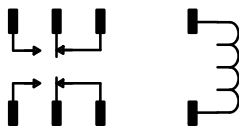

AC OPERATED

NTE Type No.	Nom. Voltage	Contact Arr.	Coil Res. Ohms (Typ)	Nom. Power	Max. Contact Cur. @ 28VDC or 120VAC	Diag No.
R25-5A16-24	24VAC	SPDT	280	-	16A	D39a
R25-5A16-120	120VAC	SPDT	5600	-	16A	D39c
R25-11A10-24	24VAC	DPDT	280	-	10A	D39c
R25-11A10-120	120VAC	DPDT	5600	-	10A	D39a

DC OPERATED

R25-1D16-5/6	5/6VDC	SPST-NO	68	500mW	16A	D39b
R25-1D16-12	12VDC	SPST-NO	270	500mW	16A	D39b
R25-1D16-24	24VDC	SPST-NO	1100	500mW	16A	D39b
R25-1D16-48	48VDC	SPST-NO	4200	500mW	16A	D39b
R25-5D16-5/6	5/6VDC	SPDT	68	500mW	16A	D39a
R25-5D16-12	12VDC	SPDT	270	500mW	16A	D39a
R25-5D16-24	24VDC	SPDT	1100	500mW	16A	D39c
R25-5D16-48	48VDC	SPDT	4200	500mW	16A	D39a
R25-11D10-5/6	5/6VDC	DPDT	68	500mW	8A	D39c
R25-11D10-12	12VDC	DPDT	270	500mW	8A	D39c
R25-11D10-24	24VDC	DPDT	1440	400mW	8A	D83b
R25-11D10-48	48VDC	DPDT	4200	500mW	8A	D39a

ACCESSORIES

MOUNTING STYLES	DESCRIPTION	NTE TYPE NO.
PC MOUNT	8-PIN	R95-132
DIN RAIL MOUNT	8-PIN	R95-131

8 Amp, 10 Amp & 16 Amp PC Mountable Relays.

D39a

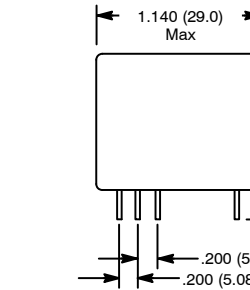

D39b

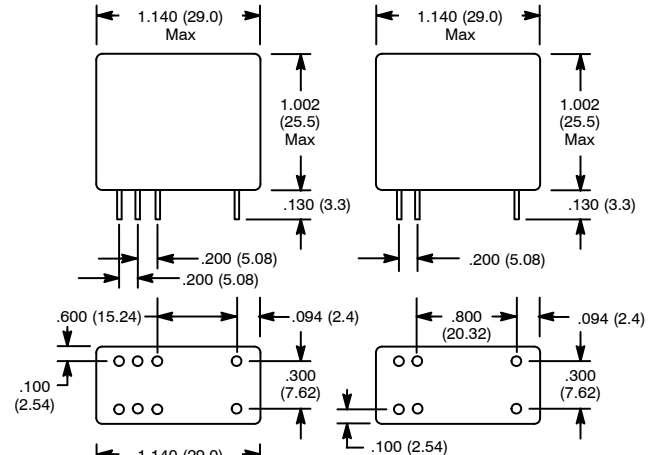

D39c

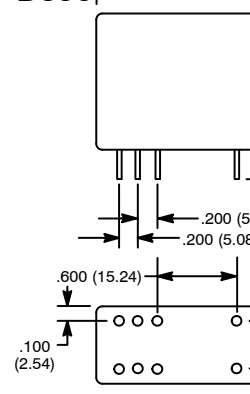

D83b

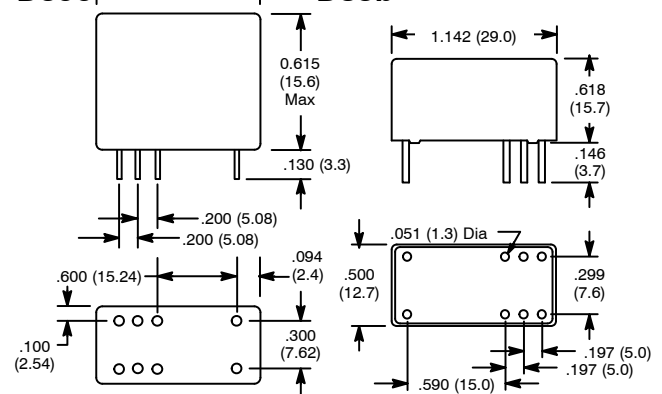

Electrical Specifications

Contact

Rating Resistive Load: 16 Amp @ 250/440 VAC,

10 Amp @ 250/440 VAC, 8 Amp @ 240VAC **

Contact Material: Silver Alloy, AgNi **

Contact Resistance: 100mΩ Max Initial

Coil

Coil Voltages: See Chart

Pick-up Voltage: 80% of rated voltage

Drop-out Voltage: 10% of rated voltage, 15% of rated voltage **

Resistance: See chart

Nominal Power: See Chart

Operational Characteristics

Timing Values Operate Time: Approx 8 mS, 20ms **

Release Time: Approx 5 mS, 10ms **

Max Switching Rate: 20 operations per second

Insulation Characteristics

Dielectric Strength

Contact To Coil: 4000 VRMS, 5000 VRMS **

Across Open Contacts: 1000 VRMS, 2500VRMS **

Environmental Characteristics

Operating: -40°C to +70°C

Mechanical Life: 30 x 10⁶ operations min, 5,000,000 operations **

Weight

Std: 18 gram approx., 10 gram approx. **

** DC operated DPDT devices ONLY