



### Description

These integrated termination networks provide high performance line termination designs for both 2.5V & 3.3V LVPECL busses.

Specifically designed shielding inside the package combined with a ceramic substrate virtually eliminates cross talk between channels that is common in other termination networks and resistor arrays.

The BGA packaging has been proven to reduce rework and improve reliability.

### Features

- 8 Bit Thevenin Termination Set
- Compliant for LVPECL Termination
- Excellent High Frequency Performance
- Slim BGA Package
- 1% Resistor Tolerance
- Low Channel to Channel Cross Talk
- RoHS Compliant Designs Available
  - Compatible with both lead and lead-free processes

### Style G

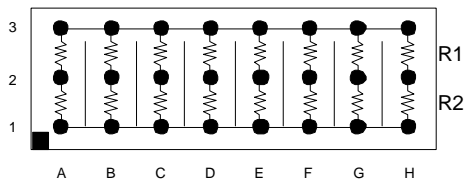

### LVPECL Thevenin Termination

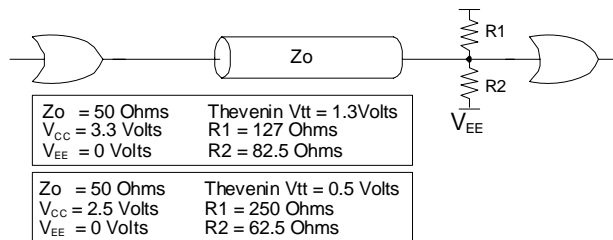

### Electrical Specifications

Resistor Tolerance:	$\pm 1.0\%$		
TCR	$\pm 200 \text{ ppm}/^\circ\text{C}$		
Operating Temperature Range	-55°C to +125°C		
Maximum Resistor Power:	<b>B6-1.27mm Pitch</b>	<b>B7-1.00mm Pitch</b>	
	RT1250 R1	96mW	60mW
	RT1250 R2	96mW	66mW
	RT1251 R1	143mW	91mW
	RT1251 R2	164mW	105mW
Maximum Package Power:	1.0 Watt at 70°C		
<b>Process Requirements:</b>			
Maximum Re-flow Temperature	Per IPC/JEDEC J-STD-020C		

### Typical Application

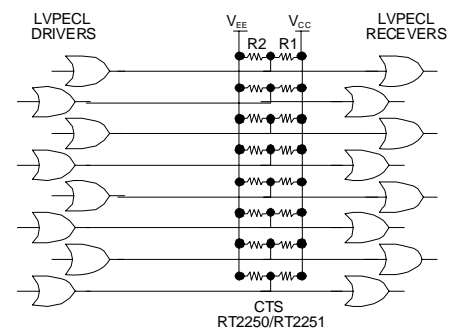

### Ordering Information

Standard Part No.	R1 $\Omega$	R2 $\Omega$	Bits	Pitch (mm)	RoHS Part No.
RT1250B6*	127	82.5	8	1.27	RT2250B6*
RT1250B7	127	82.5	8	1.00	RT2250B7
RT1251B6	250	62.5	8	1.27	RT2251B6
RT1251B7	250	62.5	8	1.00	RT2251B7

\*Indicates available Top Probe-able part numbers.  
 Refer to the following link for detailed Top Side Probe-able information:  
[www.ctscorp.com/components/clearone/TopProveClearOne.pdf](http://www.ctscorp.com/components/clearone/TopProveClearOne.pdf)

### Packaging Information

Suffix	TR7	TR13
Tape Width	24 mm	24mm
Carrier Pitch	8 mm	8 mm
Reel Diameter	7 inch	13 inch
Parts/Reel	1,000	4,000

#### Part Number Coding

7 inch reel, Add TR7 to part number, example RT2250B7TR7

13 inch reel, Add TR13 to part number, example RT2250B7TR13

(Bulk packaging is not available)

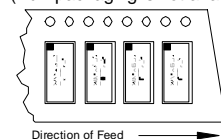

## Recommended Land Pattern

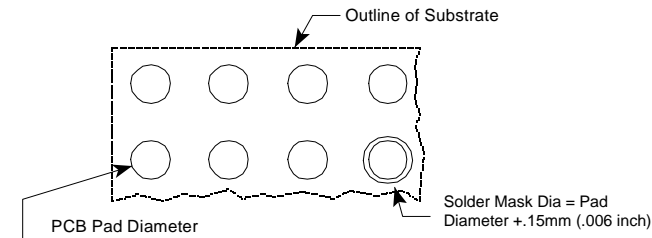

1.00mm Pitch (B7) = 0.51mm/.020 inch (minimum)  
1.27mm pitch (B6) = 0.64mm/.025 inch (minimum)

For .006" Thick Solder Paste Stencil, Aperture Opening Should be Equal to the PCB Pad Diameter.

Refer to [www.ctscorp.com/components/clearone.asp](http://www.ctscorp.com/components/clearone.asp) for additional PCB design information

## BGA Routing Scheme

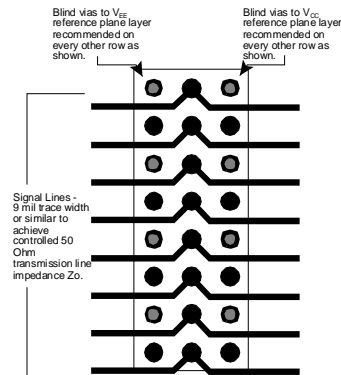

## Mechanical Diagram

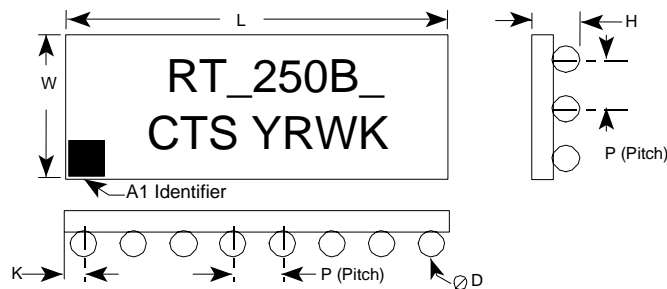

1.00mm Pitch		L	W	H	P	D	K
RT1250B7 RT2250B7 RT1251B7 RT2251B7	mm	8.00±0.15	3.00±0.15	1.19±0.15	1.00±0.25	0.64±0.05	0.50±0.25
	inch	.315±.006	.118±.006	.047±.006	.039±.010	.025±.002	.020±.010
1.27mm Pitch		L	W	H	P	D	K
RT1250B6 RT2250B6 RT1251B6 RT2251B6	mm	10.16±0.15	3.81±0.15	1.32±0.15	1.27±0.25	0.76±0.05	0.64±0.25
	inch	.400±.006	.150±.006	.052±.006	.050±.010	.030±.002	.025±.010

Complete ClearONE Product, Processing, and Application Information can be found at the following link:

<http://www.ctscorp.com/components/clearone.asp>