



Is Now Part of



**ON Semiconductor®**

To learn more about ON Semiconductor, please visit our website at  
[www.onsemi.com](http://www.onsemi.com)

ON Semiconductor and the ON Semiconductor logo are trademarks of Semiconductor Components Industries, LLC dba ON Semiconductor or its subsidiaries in the United States and/or other countries. ON Semiconductor owns the rights to a number of patents, trademarks, copyrights, trade secrets, and other intellectual property. A listing of ON Semiconductor's product/patent coverage may be accessed at [www.onsemi.com/site/pdf/Patent-Marking.pdf](http://www.onsemi.com/site/pdf/Patent-Marking.pdf). ON Semiconductor reserves the right to make changes without further notice to any products herein. ON Semiconductor makes no warranty, representation or guarantee regarding the suitability of its products for any particular purpose, nor does ON Semiconductor assume any liability arising out of the application or use of any product or circuit, and specifically disclaims any and all liability, including without limitation special, consequential or incidental damages. Buyer is responsible for its products and applications using ON Semiconductor products, including compliance with all laws, regulations and safety requirements or standards, regardless of any support or applications information provided by ON Semiconductor. "Typical" parameters which may be provided in ON Semiconductor data sheets and/or specifications can and do vary in different applications and actual performance may vary over time. All operating parameters, including "Typicals" must be validated for each customer application by customer's technical experts. ON Semiconductor does not convey any license under its patent rights nor the rights of others. ON Semiconductor products are not designed, intended, or authorized for use as a critical component in life support systems or any FDA Class 3 medical devices or medical devices with a same or similar classification in a foreign jurisdiction or any devices intended for implantation in the human body. Should Buyer purchase or use ON Semiconductor products for any such unintended or unauthorized application, Buyer shall indemnify and hold ON Semiconductor and its officers, employees, subsidiaries, affiliates, and distributors harmless against all claims, costs, damages, and expenses, and reasonable attorney fees arising out of, directly or indirectly, any claim of personal injury or death associated with such unintended or unauthorized use, even if such claim alleges that ON Semiconductor was negligent regarding the design or manufacture of the part. ON Semiconductor is an Equal Opportunity/Affirmative Action Employer. This literature is subject to all applicable copyright laws and is not for resale in any manner.

# FAB2210 — Audio Subsystem with Class-G Headphone and 3.3W Mono Class-D Speaker with Dynamic Range Compression

## Features

- High-Efficiency Stereo Class-G Headphone
  - 100 dB SNR Headphone Amplifier
  - Capacitor-Free Outputs for High-Frequency Response
- Mono Filterless Class-D Speaker Amplifier
  - 91% Efficiency for Extended Battery Runtime
  - DRC for Louder SPL and Speaker Protection
  - 3.3 W into 4 Ω at 5.0 V, THD+N < 10%
  - 1.27 W into 8 Ω at 4.2 V, THD+N < 10%
  - Low EMI Edge-Rate Controlled output
  - 97 dB Signal-to-Noise Ratio (SNR)
- Click and Pop Suppression
- Selectable Single-Ended or Differential Audio Inputs for High Common-Mode Rejection
- High Power Supply Rejection Ration (PSRR) Rejects 217 Hz GSM Noise
- Highly Configurable using I<sup>2</sup>C Control
- Low-Power, Software Standby Mode

## Description

The FAB2210 combines a Class-G stereo capacitor-free headphone amplifier with a mono Class-D speaker amplifier into one IC package.

The headphone and speaker amplifiers incorporate Class-G and Class-D topologies, respectively, for low power dissipation, which extends battery runtime.

The Class-G headphone amplifier incorporates an integrated charge pump that generates a negative supply rail for ground-centered headphone outputs.

The Class-D amplifier includes programmable Dynamic Range Compression (DRC) that maximizes Sound Pressure Level (SPL) for maximum loudness, while protecting the speaker from damage.

The noise gate can automatically mute the speaker or headphone amplifiers to reduce noise when input signals are LOW.

## Ordering Information

Part Number	Operating Temperature Range	Package	Packing Method
FAB2210UCX	-40°C to +85°C	20-Bump, Wafer-Level Chip-Scale Package (WLCSP), 0.4 mm Pitch	3000 Units on Tape & Reel

## Typical Application Circuit

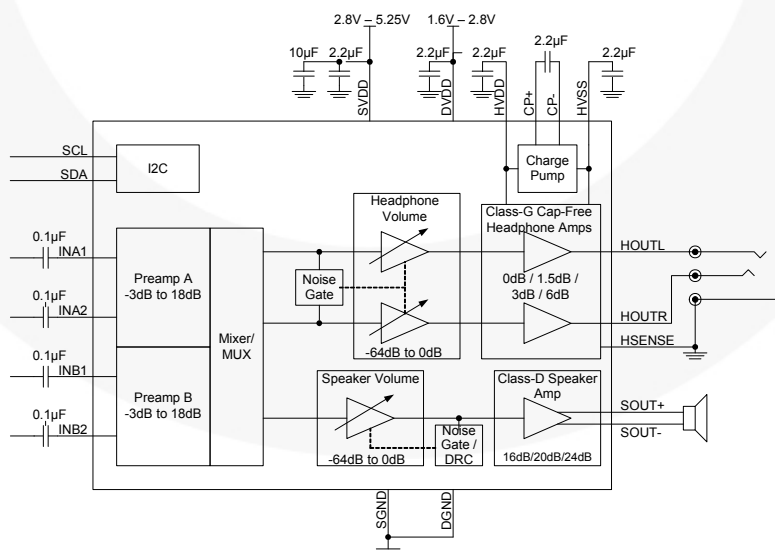

Figure 1. Typical Application Circuit

## Pin Configuration

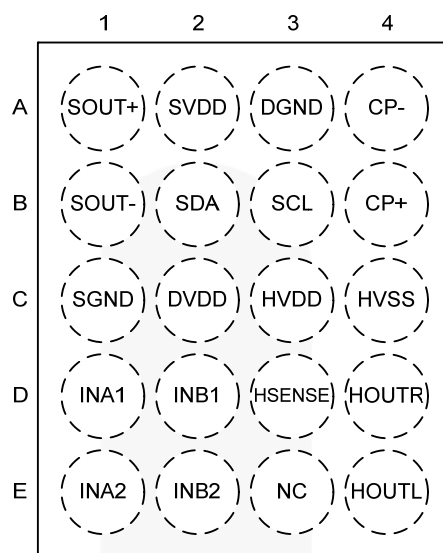

Figure 2. Pin Assignments, Top View (Bump Side Down)

## Pin Definitions

Pin #	Name	Type	Description
A2	SVDD	Power Input	Power supply for Class-D amplifier
C1	SGND	Power Input	Class-D amplifier ground
C2	DVDD	Power Input	Power supply for charge pump
A3	DGND	Power Input	Headphone amplifier ground
C3	HVDD	Power Output	Charge pump output; positive power supply for headphone amplifier, input preamplifiers, and mixers
C4	HVSS	Power Output	Charge pump output; negative mirror of HVDD
B4	CP+	Power	Charge pump flying capacitor positive terminal
A4	CP-	Power	Charge pump flying capacitor negative terminal
E3	NC	No Connect	No connect can be tied to SGND for additional thermal dissipation
D1	INA1	Input	Single-ended line level audio input A1 (or non-inverting differential input INA+)
E1	INA2	Input	Single-ended line level audio input A2 (or inverting differential input INA-)
D2	INB1	Input	Single-ended line level audio input B1 (or non-inverting differential input INB+)
E2	INB2	Input	Single-ended line level audio input B2 (or inverting differential input INB-)
E4	HOUTL	Output	Left headphone amplifier output
D4	HOUTR	Output	Right headphone amplifier output
D3	HSENSE	Input	Sense ground; connect to DGND close to shield terminal of headphone jack
A1	SOUT+	Output	Positive Class-D amplifier output
B1	SOUT-	Output	Negative Class-D amplifier output
B3	SCL	Input	I <sup>2</sup> C clock input
B2	SDA	Bidirectional	I <sup>2</sup> C data I/O

## Absolute Maximum Ratings

Stresses exceeding the absolute maximum ratings may damage the device. The device may not function or be operable above the recommended operating conditions and stressing the parts to these levels is not recommended. In addition, extended exposure to stresses above the recommended operating conditions may affect device reliability. The absolute maximum ratings are stress ratings only. All voltages are referenced to GND.

Symbol	Parameter	Min.	Max.	Unit
V <sub>DD</sub>	Voltage on SVDD Pin	-0.3	6.0	V
V <sub>DVDD</sub>	Voltage on DVDD Pin	-0.3	3.2	V
V <sub>SVDD</sub>	Voltage on SVDD + DVDD Pins		8	V
V <sub>IN</sub>	Voltage on INA1, INA2, INB1, INB2 Pins	V <sub>HVSS</sub> -0.3	V <sub>DVDD</sub> +0.3 or 2.1 <sup>(1)</sup>	V
V <sub>HOUT</sub>	Voltage on HOUTL, HOUTR Pins	V <sub>HVSS</sub> -0.3	V <sub>DVDD</sub> +0.3	V
V <sub>SENSE</sub>	Voltage on HSENSE Pin	-0.3	0.3	V
V <sub>D</sub>	Voltage on SDA, SCL Pins	-0.3	V <sub>SVDD</sub>	V
V <sub>SOUT</sub>	Voltage on SOUT+, SOUT- Pins	-0.3	V <sub>SVDD</sub> +0.3	V
R <sub>HHP</sub>	Headphone Impedance	12.8		Ω

### Note:

1. Whichever is less.

## Reliability Information

Symbol	Parameter	Min.	Typ.	Max.	Unit
T <sub>J</sub>	Junction Temperature			150	°C
T <sub>STG</sub>	Storage Temperature Range	-65		150	°C
T <sub>L</sub>	Lead Temperature (Soldering, 10 Seconds)			300	°C
θ <sub>JA</sub>	Thermal Resistance, JEDEC Standard, Multilayer Test Boards, Still Air		66		°C/W
TSD	Thermal Shutdown Threshold		150		°C
T <sub>HYS</sub>	Thermal Shutdown Hysteresis		15		°C

## Electrostatic Discharge Protection

Symbol	Parameter	Min.	Unit
ESD	Human Body Model; JESD22-A114 Level 2; Compatible with IEC61340-3-1: 2002 Level 2 or ESD-STM5.1-2001 Level 2 or MIL-STD-883E 3015.7 Level 2	±2.00	kV
	Charged Device Model; JESD22-C101 Level III Compatible with IEC61340-3-3 level C4 or ESD-STM5.3.1-1999 Level C4	±1.25	kV

## Recommended Operating Conditions

The Recommended Operating Conditions table defines the conditions for actual device operation. Recommended operating conditions are specified to ensure optimal performance to the datasheet specifications. Fairchild does not recommend exceeding them or designing to Absolute Maximum Ratings.

Symbol	Parameter	Min.	Typ.	Max.	Unit
T <sub>A</sub>	Operating Temperature Range	-40		85	°C
V <sub>SVDD</sub>	Speaker Supply Voltage Range <sup>(2,3)</sup>	2.80	3.60	5.25	V
V <sub>DVDD</sub>	Headphone Supply Voltage Range <sup>(2,3)</sup>	1.6	1.8	2.8	V

### Notes:

2. V<sub>SVDD</sub> must be greater than or equal to V<sub>DVDD</sub> at all times.
3. V<sub>SVDD</sub> and V<sub>DVDD</sub> slew rates must be less than 1 V / μs.

## Electrical Characteristics

Unless otherwise noted: audio BW=22 Hz to 20 kHz,  $f_{IN}=1$  kHz, DIFA=1, DIFB=0, HP\_AMIX=0, HP\_BMIX=1, SP\_AMIX=1, SP\_BMIX=0, unused inputs are AC grounded, DRC is off, preamplifier gains=0 dB, headphone volume=0 dB, headphone amplifier gain=0 dB, speaker volume=0 dB, SP\_GAIN=00, edge-rate control is on, spread spectrum is on, HP\_NG\_RAT=100, SP\_NG\_RAT=001, SRST=0, SDA and SCL pull-up voltage=DVDD,  $Z_{SPK} = 8 \Omega + 33 \mu H$ ,  $R_{HP} = 32 \Omega$ , HP\_HIZ=0,  $SV_{DD} = 3.6$  V,  $DV_{DD} = 1.8$  V, and  $T_A=25^\circ C$ .

Symbol	Parameter	Condition	Min.	Typ.	Max.	Unit
$I_{STBY}$	Standby Current (SRST=1)	SVDD + DVDD		2		$\mu A$
$t_{ON}$	Turn-On Time	Time from Standby to Full Speaker and Headphone Operation, ZCD and Ramps Disabled		1.6		ms
$R_{IN}$	Input Resistance	Preamplifier Gain=12.0 dB		7.7		k $\Omega$
		Preamplifier Gain=6.0 dB		12.8		
		Preamplifier Gain=4.5 dB		14.3		
		Preamplifier Gain=3.0 dB		15.9		
		Preamplifier Gain=1.5 dB		17.5		
		Preamplifier Gain=0.0 dB		19.2		
		Preamplifier Gain=-1.5 dB		20.8		
	Maximum Input Signal Swing (SVDD=2.8 V to 5.25 V, Single-Ended Input)	Preamplifier Gain=0 dB		$V_{DVDD}$		$V_{pk-pk}$
		Preamplifier Gain=12 dB		$V_{DVDD} \div 4$		$V_{pk-pk}$

## Electrical Characteristics (Speaker Amplifier)

Unless otherwise noted: audio BW=22 Hz to 20 kHz,  $f_{IN}=1$  kHz, DIFA=1, DIFB=0, HP\_AMIX=0, HP\_BMIX=0, SP\_AMIX=1, SP\_BMIX=0, unused inputs are AC grounded, DRC is off, preamplifier gains=0 dB, headphone volume=0 dB, headphone amplifier gain=0 dB, speaker volume=0 dB, SP\_GAIN=00, edge-rate control is on, spread spectrum is on, HP\_NG\_RAT=000, SP\_NG\_RAT=000, SRST=0, SDA and SCL pull-up voltage=DV<sub>DD</sub>, Z<sub>SPK</sub> = 8 Ω + 33 μH, R<sub>HP</sub>=32 Ω, HP\_HIZ=0, SV<sub>DD</sub>=3.6 V, DV<sub>DD</sub>=1.8 V, and T<sub>A</sub>=25°C.

Symbol	Parameter	Condition	Min.	Typ.	Max.	Unit
I <sub>CC</sub>	Current Consumption	SP_NG_RAT=001	SV <sub>DD</sub>		2.7	mA
			DV <sub>DD</sub>		1.6	
V <sub>OS</sub>	Output Offset Voltage	Volume=0dB		±0.4		mV
PSRR	Power-Supply Rejection Ratio	200 mV <sub>pk-pk</sub> Ripple on SV <sub>DD</sub> , SP_NG_RAT=001	f=217 Hz		70	dB
			f=1 kHz		70	
			f=20 kHz		63	
		200 mV <sub>pk-pk</sub> Ripple on SV <sub>DD</sub>	f=217 Hz		74	
			f=1 kHz		70	
			f=20 kHz		44	
P <sub>OUT</sub>	Output Power	THD+N < 10%, SV <sub>DD</sub> =5.0 V, Z <sub>SPK</sub> =4 Ω + 33 μH			3.3	W
		THD+N < 1%, SV <sub>DD</sub> =5.0 V, Z <sub>SPK</sub> =4 Ω + 33 μH			2.6	
		THD+N < 10%, SV <sub>DD</sub> =4.2 V			1.27	
		THD+N < 1%, SV <sub>DD</sub> =4.2 V			1.00	
		THD+N < 10%, SV <sub>DD</sub> =3.6 V			0.92	
		THD+N < 1%, SV <sub>DD</sub> =3.6 V			0.73	
THD+N	Total Harmonic Distortion Plus Noise	P <sub>OUT</sub> =0.7 W, SV <sub>DD</sub> =4.2 V			0.04	%
		P <sub>OUT</sub> =0.7 W, SV <sub>DD</sub> =3.6 V			0.17	
SNR	Signal-to-Noise Ratio	A-wt, P <sub>OUT</sub> =700 mW			97	dB
		A-wt, P <sub>OUT</sub> =700 mW, SV <sub>DD</sub> =4.2 V			97	
	Class-D Frequency	Spread Spectrum			300	kHz
		Fixed Frequency			300	
	Efficiency	P <sub>OUT</sub> =720 mW			91	%
	DC Detect Voltage	Absolute Value, Measured Differentially Across SOUT+ and SOUT-			1.5	V <sub>pk</sub>
t <sub>DCERR</sub>	DC Detect Time	DCERR_TIME=10			15	ms
		DCERR_TIME=01			5	
		DCERR_TIME=00			2	
	Single-Ended Output Impedance	Amp. Off, SP_HIZ=0, f < 40 kHz			2	kΩ
		OTP_ERR=1, f < 40 kHz			2	
		DC_ERR=1, f < 40 kHz			2	
		Amp. Off, SP_HIZ=1, f < 40 kHz			35	
		OCP_ERR=1, f < 40 kHz			2	

## Electrical Characteristics (Headphone Amplifiers)

Unless otherwise noted: audio BW=22 Hz to 20 kHz,  $f_{IN}=1$  kHz, DIFA=1, DIFB=0, HP\_AMIX=0, HP\_BMIX=1, SP\_AMIX=0, SP\_BMIX=0, unused inputs are AC grounded, DRC is off, preamplifier gains=0 dB, headphone volume=0 dB, headphone amplifier gain=0 dB, speaker volume=0 dB, SP\_GAIN=00, edge-rate control is on, spread spectrum is on, HP\_NG\_RAT=000, SP\_NG\_RAT=000, SRST=0, SDA and SCL pull-up voltage=DV<sub>DD</sub>, Z<sub>SPK</sub> = 8 Ω + 33 μH, R<sub>HP</sub>=32 Ω, HP\_HIZ=0, SV<sub>DD</sub>=3.6 V, DV<sub>DD</sub>=1.8 V, and T<sub>A</sub>=25°C.

Symbol	Parameter	Condition		Min.	Typ.	Max.	Unit
I <sub>CC</sub>	Current Consumption	HP_NG_RAT=100	SVDD		0.8		mA
			DVDD		1.9		
V <sub>OS</sub>	Output Offset Voltage	Volume=Mute			±0.1		mV
PSRR	Power-Supply Rejection Ratio	200 mV <sub>pk-pk</sub> Ripple on SVDD, HP_NG_RAT=100	f=217 Hz		93		dB
			f=1 kHz		94		
			f=20 kHz		97		
		200 mV <sub>pk-pk</sub> Ripple on SVDD	f=217 Hz		93		dB
			f=1 kHz		93		
			f=20 kHz		97		
P <sub>OUT</sub>	Output Power	THD+N < 0.1%			27		mW
		THD+N < 1%, Headphone Amplifier Gain=6dB			29		
		THD+N < 1%, Headphone Amplifier Gain=6 dB, SV <sub>DD</sub> =4.2 V			29		
THD+N	Total Harmonic Distortion Plus Noise	P <sub>OUT</sub> =10 mW			0.01		%
		P <sub>OUT</sub> =10 mW, SV <sub>DD</sub> =4.2 V			0.01		
		P <sub>OUT</sub> =20 mW			0.01		
SNR	Signal-to-Noise Ratio	A-wt, HP_NG_RAT=100	P <sub>OUT</sub> =10 mW, SV <sub>DD</sub> =3.6 V		102.5		dB
			P <sub>OUT</sub> =10 mW, SV <sub>DD</sub> =4.2 V		102.5		
			P <sub>OUT</sub> =20 mW		105.5		
		A-wt, HP_NG_RAT=000	P <sub>OUT</sub> =10 mW, SV <sub>DD</sub> =3.6 V		97.0		
			P <sub>OUT</sub> =10 mW, SV <sub>DD</sub> =4.2 V		97.0		
			P <sub>OUT</sub> =20 mW		100.0		
C <sub>L</sub>	Capacitive Drive				100		pF
Xtak	Crosstalk	P <sub>OUT</sub> =10 mW, f=100 Hz			-96		dB
		P <sub>OUT</sub> =20 mW, f=100 Hz			-95		
		P <sub>OUT</sub> =10 mW, f=1 kHz			-93		
		P <sub>OUT</sub> =20 mW, f=1 kHz			-92		
		P <sub>OUT</sub> =10 mW, f=10 kHz			-79		
		P <sub>OUT</sub> =20 mW, f=10 kHz			-79		
		Headphone to Speaker, P <sub>OUT</sub> =10 mWx2			-91		
		Speaker to Headphone, P <sub>OUT</sub> =700 mW			-106		
	Output Impedance	Amp. Off, HP_HIZ=0			130		Ω
		OTP_ERR=1			170		Ω
		Amplifier Off, HP_HIZ=1			15		kΩ

## I<sup>2</sup>C DC Electrical Characteristics

Unless otherwise noted, SV<sub>DD</sub>=2.8 V to 5.25 V, DV<sub>DD</sub>=1.6 V to 2.8 V, T<sub>A</sub>=-40°C to 85°C.

Symbol	Parameter	Fast Mode (400 kHz)		
		Min.	Max.	Unit
V <sub>IL</sub>	Low-Level Input Voltage	-0.3	0.6	V
V <sub>IH</sub>	High-Level Input Voltage	1.3		V
V <sub>OL</sub>	Low-Level Output Voltage at 3 mA Sink Current (Open-Drain or Open-Collector)	0	0.4	V
I <sub>IH</sub>	High-Level Input Current of Each I/O Pin, Input Voltage=V <sub>SVDD</sub>	-1	1	μA
I <sub>IL</sub>	Low-Level Input Current of Each I/O Pin, Input Voltage=0V	-1	1	μA

## I<sup>2</sup>C AC Electrical Characteristics

Unless otherwise noted, SV<sub>DD</sub>=2.8 V to 5.25 V, DV<sub>DD</sub>=1.6 V to 2.8 V, T<sub>A</sub>=-40°C to 85°C.

Symbol	Parameter	Fast Mode (400 kHz)		
		Min.	Max.	Unit
f <sub>SCL</sub>	SCL Clock Frequency	0	400	kHz
t <sub>HD;STA</sub>	Hold Time (Repeated) START Condition	0.6		μs
t <sub>LOW</sub>	Low Period of SCL Clock	1.3		μs
t <sub>HIGH</sub>	High Period of SCL Clock	0.6		μs
t <sub>SU;STA</sub>	Set-up Time for Repeated START Condition	0.6		μs
t <sub>HD;DAT</sub>	Data Hold Time	0	0.9	μs
t <sub>SU;DAT</sub>	Data Set-up Time <sup>(4)</sup>	100		ns
t <sub>r</sub>	Rise Time of SDA and SCL Signals <sup>(5)</sup>	20+0.1C <sub>b</sub>	300	ns
t <sub>f</sub>	Fall Time of SDA and SCL Signals <sup>(5)</sup>	20+0.1C <sub>b</sub>	300	ns
t <sub>SU;STO</sub>	Set-up Time for STOP Condition	0.6		μs
t <sub>BUF</sub>	Bus-Free Time between STOP and START Conditions	1.3		μs
t <sub>SP</sub>	Pulse Width of Spikes that Must Be Suppressed by the Input Filter	0	50	ns

### Notes:

- A Fast-Mode I<sup>2</sup>C Bus® device can be used in a Standard-Mode I<sup>2</sup>C Bus system, but the requirement t<sub>SU;DAT</sub> ≥ 250 ns must then be met. This is automatically the case if the device does not stretch the LOW period of the SCL signal. If such a device does stretch the LOW period of the SCL signal, it must output the next data bit to the Serial Data (SDA) line t<sub>r,max</sub> + t<sub>SU;DAT</sub>=1000 + 250=1250 ns (according to the Standard-Mode I<sup>2</sup>C Bus specification) before the SCL line is released.
- C<sub>b</sub> equals the total capacitance of one bus line in pf. If mixed with High-Speed Mode devices, faster fall times are allowed according to the I<sup>2</sup>C specification.

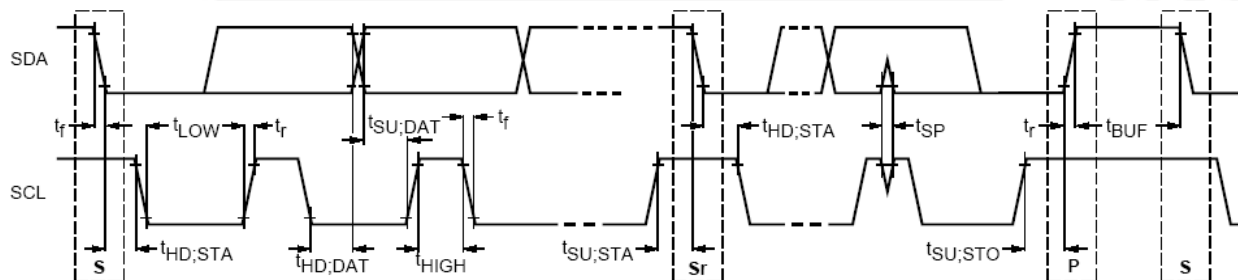

Figure 3. Definition of Timing for Full-Speed Mode Devices on the I<sup>2</sup>C Bus



## Typical Performance Characteristics

### System

Unless otherwise noted: audio BW=22 Hz to 20 kHz,  $f_{IN}=1$  kHz, DIFA=1, DIFB=0, HP\_AMIX=0, HP\_BMIX=1, SP\_AMIX=1, SP\_BMIX=0, unused inputs are AC grounded, DRC is off, preamplifier gains=0 dB, headphone volume=0 dB, headphone amplifier gain=0 dB, speaker volume=0 dB, SP\_GAIN=00, edge-rate control is on, spread spectrum is on, HP\_NG\_RAT=100, SP\_NG\_RAT=001, SRST=0, SDA and SCL pull-up voltage=DV<sub>DD</sub>, Z<sub>SPK</sub> = 8 Ω + 33 μH, R<sub>HP</sub>=32 Ω, HP\_HIZ=0, SV<sub>DD</sub>=3.6 V, DV<sub>DD</sub>=1.8 V, and T<sub>A</sub>=25°C.

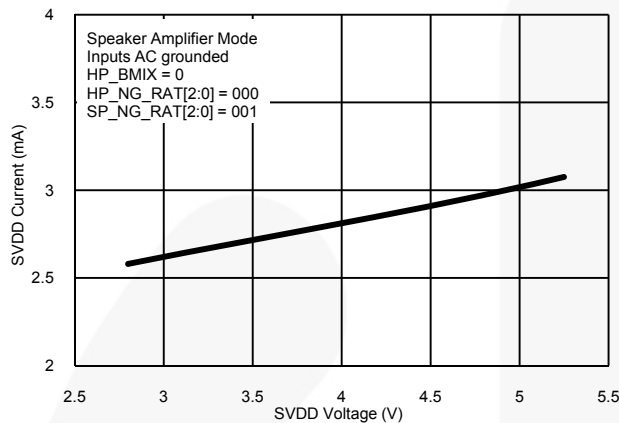

**Figure 4. Quiescent Current vs. Supply Voltage**

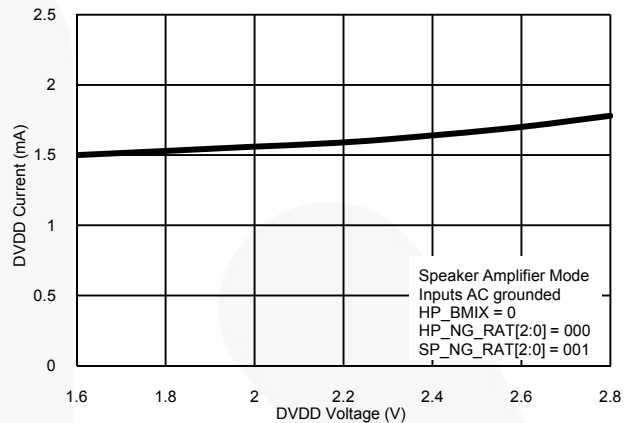

**Figure 5. Quiescent Current vs. Supply Voltage**

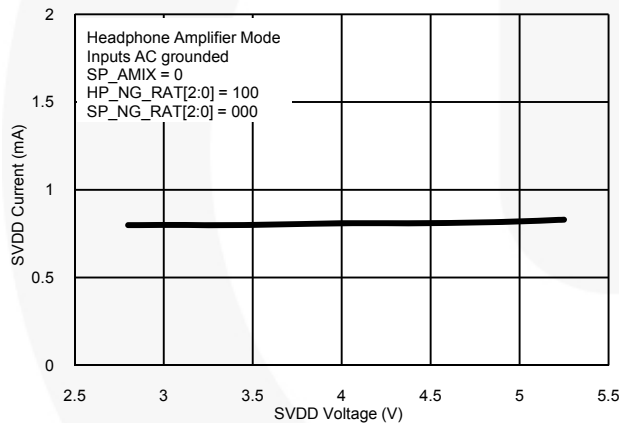

**Figure 6. Quiescent Current vs. Supply Voltage**

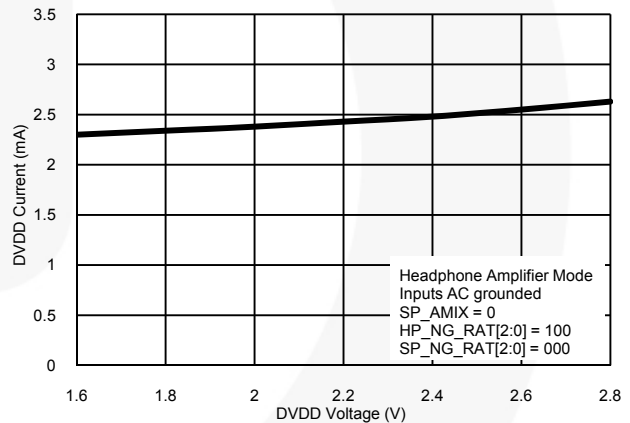

**Figure 7. Quiescent Current vs. Supply Voltage**

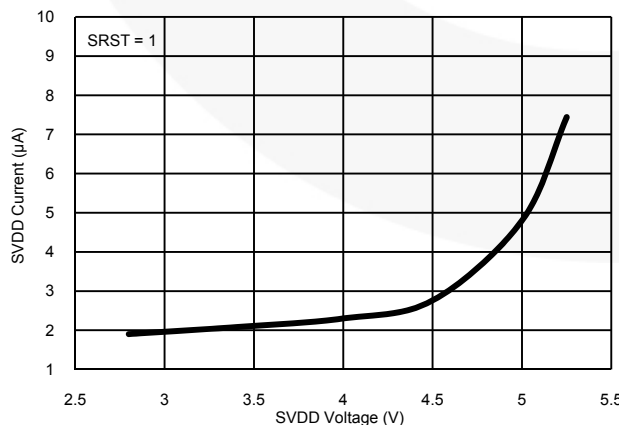

**Figure 8. Standby Current vs. Supply Voltage**

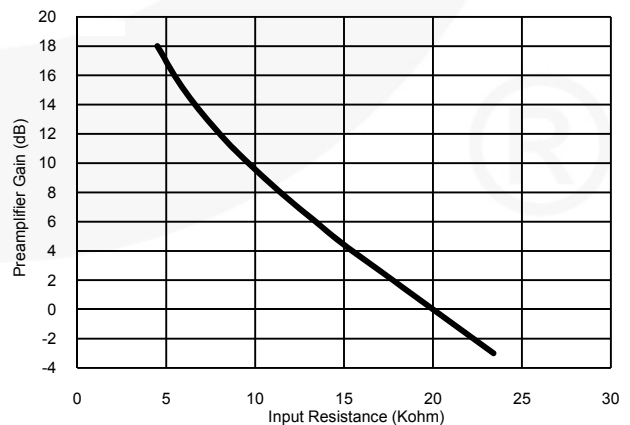

**Figure 9. Input Resistance vs. Preamplifier Gain**

## Typical Performance Characteristics

### Speaker Amplifier

Unless otherwise noted: audio BW=22 Hz to 20 kHz,  $f_{IN}=1$  kHz, DIFA=1, DIFB=0, HP\_AMIX=0, HP\_BMIX=0, SP\_AMIX=1, SP\_BMIX=0, unused inputs are AC grounded, DRC is off, preamplifier gains=0 dB, headphone volume=0 dB, headphone amplifier gain=0 dB, speaker volume=0 dB, SP\_GAIN=00, edge-rate control is on, spread spectrum is on, HP\_NG\_RAT=000, SP\_NG\_RAT=000, SRST=0, SDA and SCL pull-up voltage=DV<sub>DD</sub>, Z<sub>SPK</sub>=8 Ω + 33 μH, R<sub>HP</sub>=32 Ω, HP\_HIZ=0, SV<sub>DD</sub>=3.6 V, DV<sub>DD</sub>=1.8 V, and T<sub>A</sub>=25°C.

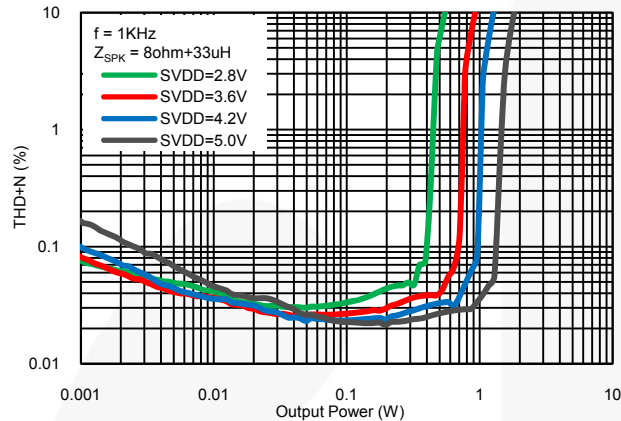

Figure 10. THD+N vs. Output Power

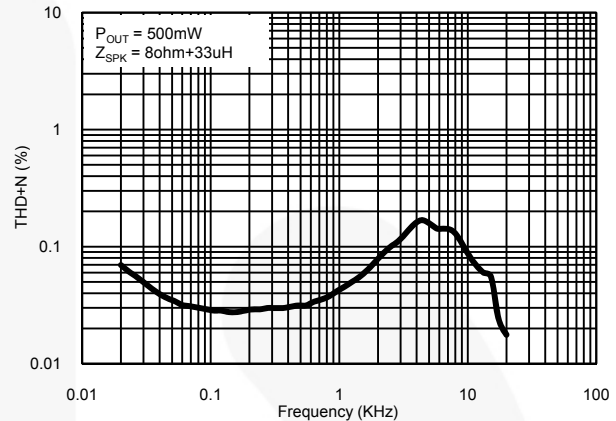

Figure 11. THD+N vs. Frequency

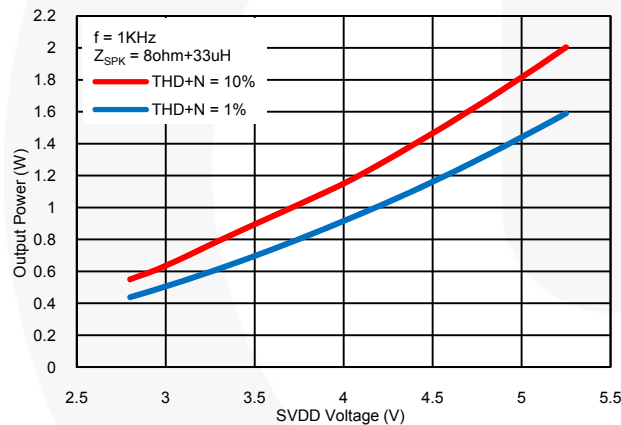

Figure 12. Output Power vs. Supply Voltage

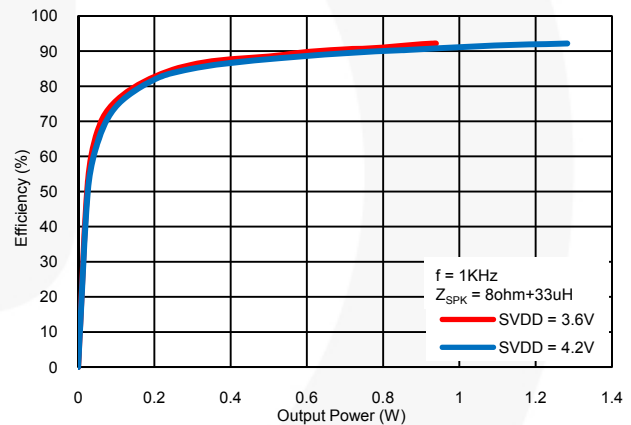

Figure 13. Efficiency vs. Output Power

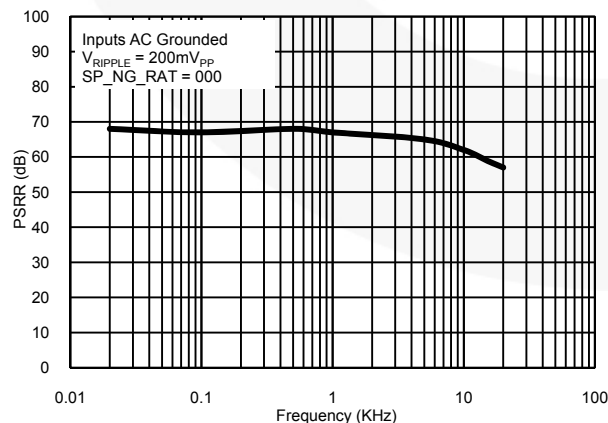

Figure 14. PSRR vs. Frequency

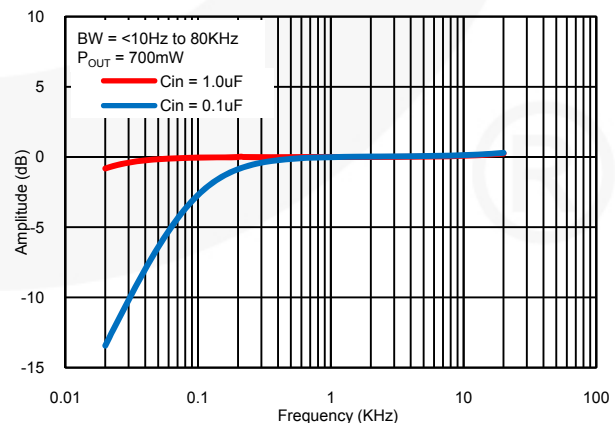

Figure 15. Frequency Response

## Typical Performance Characteristics

### Speaker Amplifier (Continued)

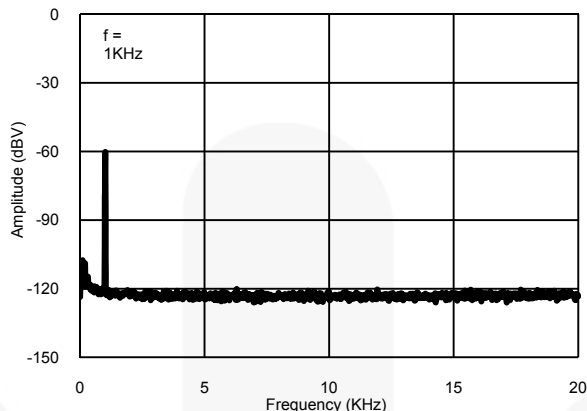

Figure 16. Output vs. Frequency

### Headphone Amplifiers

Unless otherwise noted: audio BW=22 Hz to 20 kHz,  $f_{IN}=1$  kHz, DIFA=1, DIFB=0, HP\_AMIX=0, HP\_BMIX=1, SP\_AMIX=0, SP\_BMIX=0, unused inputs are AC grounded, DRC is off, preamplifier gains=0 dB, headphone volume=0 dB, headphone amplifier gain=0 dB, speaker volume=0 dB, SP\_GAIN=00, edge-rate control is on, spread spectrum is on, HP\_NG\_RAT=000, SP\_NG\_RAT=000, SRST=0, SDA and SCL pull-up voltage= $DV_{DD}$ ,  $Z_{SPK} = 8 \Omega + 33 \mu H$ ,  $R_{HP}=32 \Omega$ ,  $HP_{HIZ}=0$ ,  $SV_{DD}=3.6$  V,  $DV_{DD}=1.8$  V, and  $T_A=25^\circ C$ .

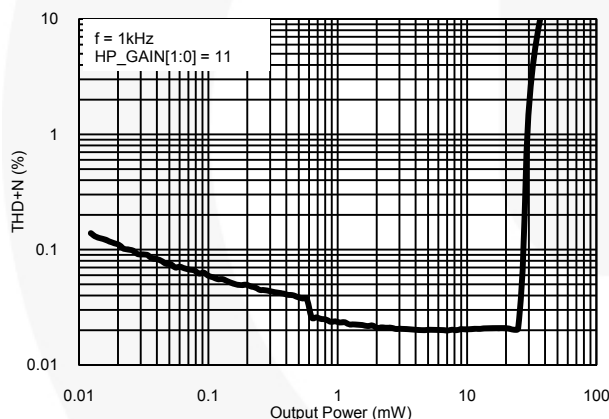

Figure 17. THD+N vs. Output Power

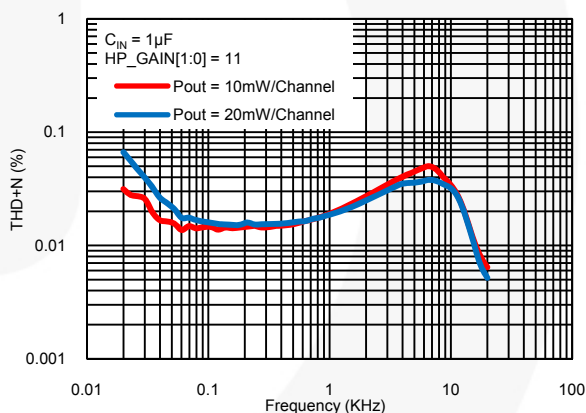

Figure 18. THD+N vs. Frequency

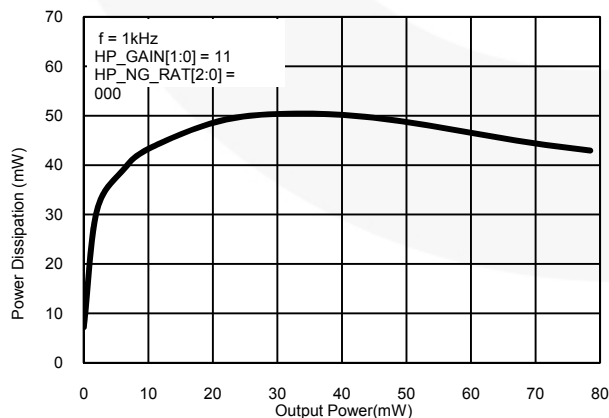

Figure 19. Power Dissipation vs. Output Power

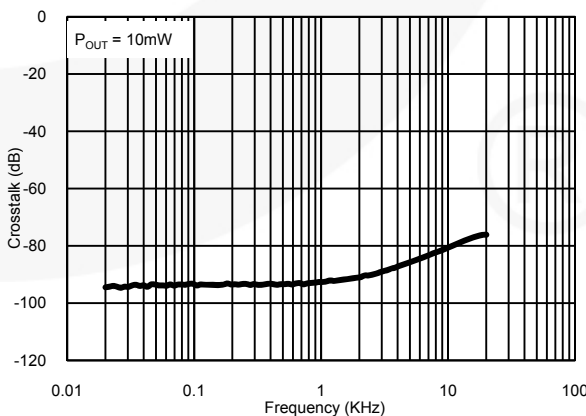

Figure 20. Crosstalk vs. Frequency

## Typical Performance Characteristics

### Headphone Amplifiers (Continued)

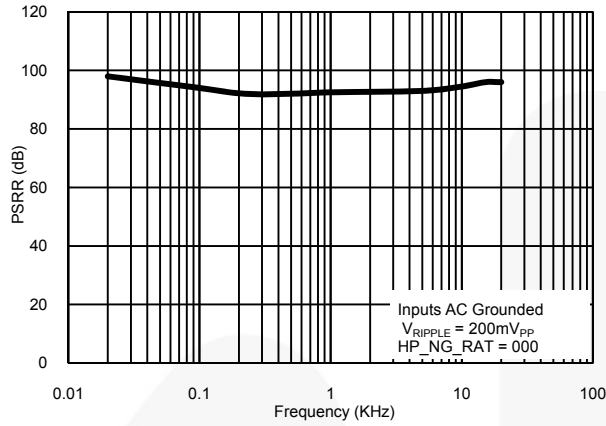

Figure 21. PSRR vs. Frequency

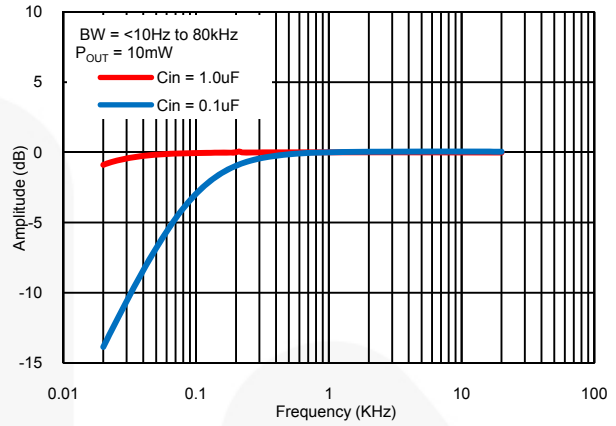

Figure 22. Frequency Response

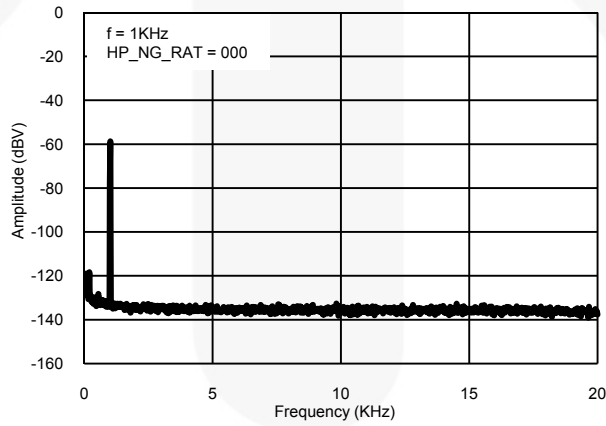

Figure 23. Output vs. Frequency

## Detailed Description

### Shutdown Modes

#### Standby

When the SRST bit is set to 1, the FAB2210 enters a low-power Standby Mode.

While SRST=1, I<sup>2</sup>C communications are available and I<sup>2</sup>C values are reset to default values. Any values written to the I<sup>2</sup>C registers (except SRST) while in Standby Mode are ignored and default values is preserved.

To achieve low supply current during Standby Mode, all inputs must be DC. Audio inputs must be AC grounded. V<sub>SVDD</sub> and V<sub>DVDD</sub> must be within recommended operating conditions. I<sup>2</sup>C pins must be grounded or pulled HIGH with no toggling. If AC is presented to the inputs during Standby Mode, standby current may increase slightly, but there are no other negative effects.

#### Thermal Shutdown Protection (TSP)

If the junction temperature of the device exceeds the thermal shutdown threshold of 150°C (see the *Electrical Characteristics table*), the device protects itself by turning off the amplifiers. The I<sup>2</sup>C port remains functional and the OTP\_ERR bit is set to 1. Other bits retain their values and are not reset. See the *Electrical Characteristics table for output impedances*. The amplifiers remain off until the junction temperature falls below the thermal shutdown recovery point and SRST is cycled or power is cycled.

#### Over-Current Protection (OCP)

If the speaker amplifier's output current limit of 1.3 A<sub>PEAK</sub> is exceeded (see the *Electrical Characteristics table*), the amplifier turns off. During current-limit shutdown, the I<sup>2</sup>C port remains functional and the OCP\_ERR bit is set to 1. Other bits retain their values and are not reset. The speaker amplifier remains off and the OCP\_ERR remains HIGH until SRST is cycled or power is cycled.

#### DC Output Protection

If the magnitude of the speaker amplifier output voltage across SOUT+ and SOUT- exceeds the DC detect voltage of 1.5 V<sub>pk</sub> for more than t<sub>DCERR</sub> (see the *Electrical Characteristics table*), the speaker amplifier turns off. This protects the loudspeaker from damage due to DC signals. Low-frequency audio input signals may trigger unintentional DC output shutdown. Set the input DC coupling capacitor value small enough to avoid a DC output shutdown caused by a low-frequency audio signal. For the default t<sub>DCERR</sub> setting of 2 ms, the input DC-coupling capacitor value must be 0.1 μF or lower.

During DC output shutdown, the I<sup>2</sup>C port remains functional and the DC\_ERR bit is set to 1. Other bits retain their values and are not reset. The speaker amplifier remains off and the DC\_ERR bit remains HIGH until SRST is cycled or power is cycled.

### Signal Path

Audio signals pass from the input pins through a preamplifier, a mixer, a volume control, and finally through an amplifier. The preamplifiers can be set to -3 dB to 18 dB of gain. The headphone and speaker paths have volume controls that range from -64 dB to 0dB. The headphone amplifier has gain settings of 0 dB, 1.5 dB, 3 dB, and 6 dB. The speaker amplifier has gain settings of 16 dB, 20 dB, and 24 dB.

A variety of combinations of the input signals can be routed from the preamplifiers to the headphone and speaker volume blocks. Routing is controlled by the HP\_AMIX, HP\_BMIX, SP\_AMIX, SP\_BMIX, DIFA, DIFB, and MONO bits.

For example, to connect the left headphone amplifier channel to INA1 and the right headphone amplifier channel to INA2, set HP\_AMIX to 1. HP\_BMIX, DIFA, and MONO should be set to 0.

To configure INB1 and INB2 as a differential input and route the signal to the speaker amplifier, set DIFB and SP\_BMIX to 1. SP\_AMIX should be set to 0.

When HP\_AMIX and HP\_BMIX are both 0, the headphone amplifier is off. When SP\_AMIX and SP\_BMIX are both 0, the speaker amplifier is off.

Unused audio input pins must be grounded either directly or through a DC-blocking capacitor.

To prevent internal clipping in the headphone amplifier path, internal signal amplitudes from the preamplifier outputs to the headphone amplifier input should not exceed a peak-to-peak voltage equivalent to V<sub>DVDD</sub> - 0.2 V. If HP\_MONO = 1, the peak-to-peak voltage can be as high as (V<sub>DVDD</sub> \* 2) - 0.2 V. Extra caution should be taken if mixing signals together.

To prevent internal clipping in the speaker amplifier path, internal signal amplitudes from the preamplifier outputs to the speaker amplifier input should not exceed a peak-to-peak voltage equivalent to V<sub>DVDD</sub> - 0.2 V. Extra caution should be taken if mixing signals together.

### Charge Pump

The FAB2210 includes an inverting charge pump that generates HVDD and HVSS (the headphone amplifier power supplies) from the DVDD power supply input. The HVSS rail is a negative mirror of HVDD and allows the headphone amplifier to be ground referenced. The ground-referenced biasing scheme allows the headphone amplifier outputs to be biased at ground while operating from a single external supply. This eliminates the need for the large, expensive, DC-coupling capacitors between the headphone amplifier output and load that are required on traditional, single-supply,  $V_{DD}/2$ , biased headphone amplifiers.

The negative HVSS rail allows the input preamplifiers to be ground referenced. Input DC-blocking capacitors are still required at INA1, INA2, INB1, and INB2 if the audio source driving the input preamplifiers is biased above ground. The input DC-blocking capacitors are not required if the audio source driving the input preamplifiers is also ground referenced and does not present any DC offset to the FAB2210.

### Class-G Operation

Compared with a traditional Class-AB amplifier, the FAB2210's Class-G architecture reduces power consumption and extends battery life during headphone playback. The power supply rails (HVDD and HVSS) of the Class-G headphone amplifier adapt to the level of audio signal present at the output. The adaptive nature of the power supply rails ensures that energy is not wasted during quiet passages of music or when the volume of the headphone path is reduced.

During stereo headphone playback, when the headphone output amplitude is below the  $V_{TH}$  threshold level of 250 mV<sub>pk</sub> (typical); the charge pump efficiently divides  $V_{DVDD}$  so that  $V_{HVSS} = -V_{DVDD}/2$  and  $V_{HVDD} = V_{DVDD}/2$ . When the headphone output amplitude exceeds 250 mV<sub>pk</sub> (typical), the charge pump generates higher magnitude rails, where  $V_{HVSS} = -V_{DVDD}$  and  $V_{HVDD} = V_{DVDD}$  to allow for higher output amplitudes. Due to the high crest factor of music and speech, a significant portion of the audio content is below the  $V_{TH}$  threshold, even at typical volume level settings for headphone playback. When operating at the lower magnitude rails, less power is dissipated within the headphone amplifier.

The transition from the lower magnitude rails to the higher magnitude rails occurs fast enough to prevent audible artifacts during headphone playback. The transition from the higher magnitude rails to the lower magnitude rails occurs 15 ms (typical) from the last threshold crossing (low to high) and only after the headphone output amplitude has stayed below the threshold level. The 15 ms (typical) hysteresis prevents the headphone amplifier power rails from bouncing between high and low rails when the audio signal approaches the threshold level.

Due to the flexible input to output routing capabilities of the FAB2210, additional logic added to the Class-G audio-level-detection circuit ensures that enough headroom is available to avoid saturating the audio input signals at the INA1, INA2, INB1, and INB2 preamplifiers. This is especially useful in cases where both the Class-D amplifier path and/or mono headphone path are selected for playback.

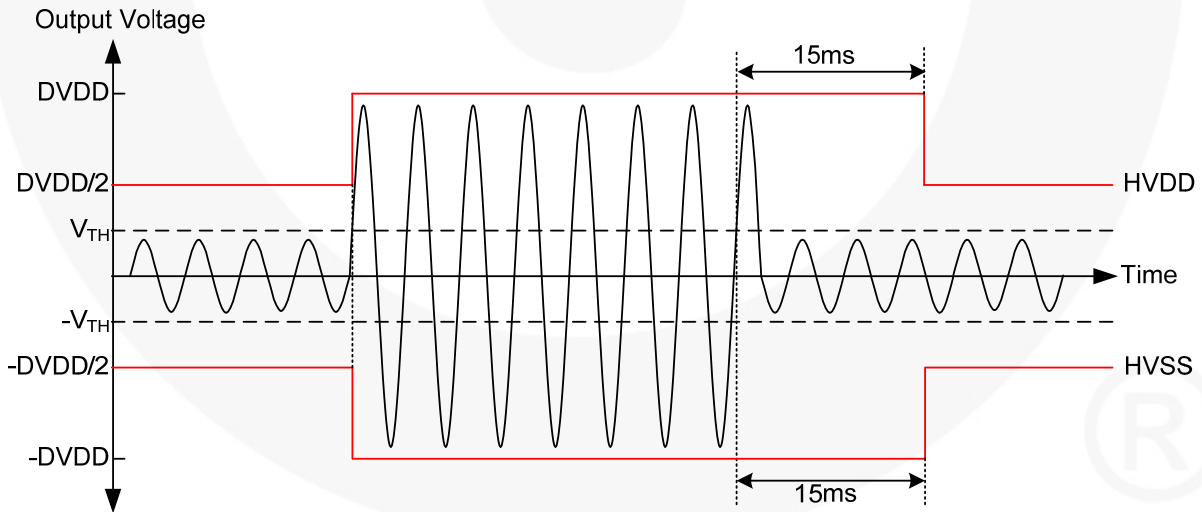

Figure 24. Class-G Headphone Amplifier Power Supply Rail Operation

### Headphone Amplifier High-Impedance Mode

The FAB2210 headphone outputs are placed in a High-Impedance Mode by setting the HP\_HIZ bit to 1 and turning off the headphone amplifier. This can be useful if the system's headphone jack is shared with other devices. For proper high-impedance operation, SRST must be set to 0 and the headphone amplifier must be off (see HP\_MONO, HPAMIX, and HP\_BMIX register definitions). Voltages on the HOUTL and HOUTR pins must not exceed DVDD and must not be below -DVDD.

### Headphone Volume Ramp and Zero Crossing Detection

The HP\_SVOFF and HP\_ZCSOFF bits control the headphone volume when HP\_ATT is changed.

HP\_SVOFF and HP\_ZCSOFF do not slow down turn-on or turn-off when using the HP\_AMIX, HP\_BMIX, or SRST bits. Thermal shutdown conditions are not slowed by HP\_SVOFF or HP\_ZCSOFF.

**Table 1.** Headphone Volume-Change Behavior

HP_SVOFF	HP_ZCSOFF	Behavior when HP_ATT is Changed
1	1	Volume changes immediately.
1	0	For each channel, wait until a zero crossing occurs in the input before changing volume. If a zero crossing does not occur within 200 $\mu$ s, volume is forced to the new setting.
0	1	Volume is ramped to the new setting at a rate of 200 $\mu$ s per step.
0	0	Volume is changed by one step when a zero crossing occurs. If a zero crossing does not occur within 200 $\mu$ s, a step is forced. Only the first zero crossing within 200 $\mu$ s triggers a volume change; volume does not change again until the next 200 $\mu$ s.

### Headphone Amplifier Noise Gate

The headphone noise gate automatically reduces the headphone volume when its input amplitudes are low to reduce noise during inactivity. (This function is more useful for speech than music.) The amplitude is measured after input preamplifiers, but before the headphone volume control. The headphone noise gate's threshold level is set by the HP\_NG\_RAT register. The amplitudes of both channels must be less than the noise gate threshold for the hold-time determined by the NG\_ATRT register.

The amount of volume reduction is set by the HP\_NG\_ATT register. The speed at which the volume is reduced is determined by the attack time setting in the NG\_ATRT register. When the volume is reduced by the noise gate, the HP\_ATT register's readback value remains unchanged. An internal register keeps track of the actual volume setting.

If either headphone channel's amplitude goes above the headphone noise gate threshold, headphone volume is raised back to the HP\_ATT value at a rate determined by the release time setting in the NG\_ATRT register. If HP\_MONO=1, only left channel amplitude is monitored.

To avoid unpredictable behavior, noise gate settings should not change while the headphone amplifier is on.

### Class-D Speaker Amplifier

The FAB2210 utilizes a "Filterless" modulation scheme to achieve 92% efficiency, extending battery life and reducing component count. The pulse-width modulated, differential outputs of the Class-D amplifier switch at 300 kHz. When an audio input signal is not present, the Class-D outputs switch in-phase at 50% duty cycle, minimizing idle current and saving power.

### Programmable Spread Spectrum Modulation

Spread spectrum modulation is employed to reduce EMI generated at the Class-D amplifier outputs. Spread spectrum modulates the Class-D amplifier's switching frequency by a programmable percentage centered around the base switching frequency of 300 kHz, dispersing the spectral energy of the switching waveform over a wider band. This significantly reduces the amount of concentrated spectral energy at multiples of the switching frequency that fixed-frequency Class-D amplifiers emit. Spread spectrum modulation eliminates the need for output filters, as long as the distance from the Class-D amplifier outputs to the speaker transducer is kept short.

### Edge Rate Control (ERC)

The Edge Rate Control (ERC) circuit minimizes EMI generated by the high-current switching waveform of the Class-D amplifier output. One of the main contributors to EMI generated by Class-D amplifiers is the high-frequency energy produced by rapid (large dV/dt) transitions at the edges of the switching waveform. The ERC circuit suppresses the high-frequency component of the switching waveform by extending the rise and fall times of the output FET transitions, without compromising efficiency and THD+N performance. Rise and fall times are set to approximately 20ns per transition at all power levels.

## Dynamic Range Compression (DRC)

The speaker amplifier's DRC can be used to limit output amplitude and reduce clipping even as the supply voltage varies. The DRC allows high gain settings while preventing distortion and speaker damage. This results in louder speaker playback without increasing the maximum peak amplitude of the speaker signal path.

To avoid unpredictable behavior, DRC settings should not be changed while the speaker amplifier is on.

Figure 25 shows the speaker amplifier's target output amplitude with respect to the DRC's input amplitude when programmed at various Class-D output gain settings. The DRC's input amplitude is measured after the speaker volume control, but before the speaker amplifier block.

The DRC has three regions of operation: linear, compression, and limiter. When the output amplitude is initially low, the DRC operates in the linear region and does not apply any gain changes to the signal. The volume control remains fixed at the level defined in SP\_ATT. When the output amplitude has increased above the dynamic range compression threshold, the DRC reduces the gain of SP\_ATT, thereby applying compression to the output signal.

The compression region is defined by the compression ratio and the dynamic range compression threshold. The dynamic range compression threshold is set by the DPLT register. The dynamic range compression threshold is set 8 dB below the DPLT threshold level. The DRC applies a 2:1 compression ratio for output signals between the dynamic range compression threshold and limiter threshold. In the compression region; for every 2 dB rise of input amplitude, the target output amplitude only rises by 1 dB. This continues until the output amplitude has increased above the DRC limiter threshold.

The limiter region is defined by the DALC and DPLT registers. In the limiter region, the target output amplitude does not increase with the input amplitude. The DPLT register sets an output voltage limit independent of the battery voltage. This is useful for speaker protection. The DALC register defines an output voltage limit that is a percentage of the battery voltage. Since the battery voltage sets the maximum output amplitude, the DALC register is used as a distortion limiter by setting the allowed clipping amount.

The DRC limiter threshold is defined as the lower of the two limiter voltages set by the DPLT and DALC settings. For example, in Figure 27; if DPLT=111, DALC=001, and  $SV_{DD}=4.5 V_{pk}$ , the DRC limit is  $3.79 V_{pk}$  as defined by DPLT. However, if  $SV_{DD}$  falls to  $3.0 V$ , the DRC limiter threshold falls to  $2.7 V_{pk}$ , as defined by DALC.

The speed at which gain is changed is regulated by the attack and release settings in the DATRT register. Figure 28 shows DRC attack and release behavior.

DRC attack occurs when the DRC determines that, for given input amplitude, the actual output amplitude is higher than the target output amplitude and attack speed (defined in the DATRT register) is not to be exceeded. When these criteria are met, volume is reduced by one step.

DRC release occurs when the DRC determines that, for a given input amplitude, the actual output amplitude is lower than the target output amplitude and release speed (defined in the DATRT register) is not to be exceeded. When these criteria are met, volume is increased by one step.

When the volume is changed by the DRC, the SP\_ATT register readback value remains unchanged. An internal register keeps track of the actual volume setting.

When 2:1 compression is enabled, the overall gain of the speaker amplifier path is increased by 6 dB, as shown in Figure 26.

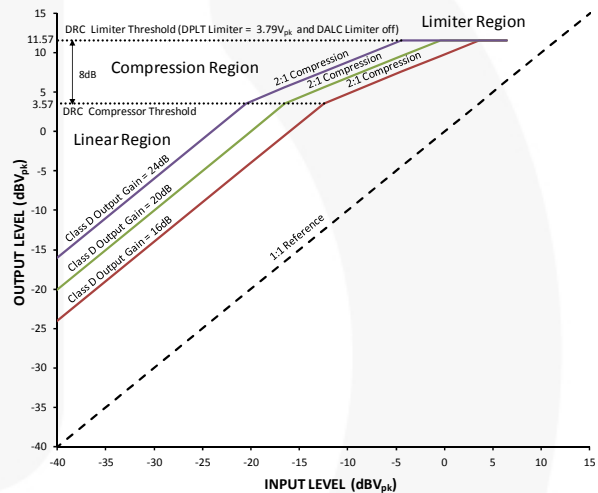

**Figure 25. Dynamic Range Compression Response vs. Class-D Output Gain Settings**

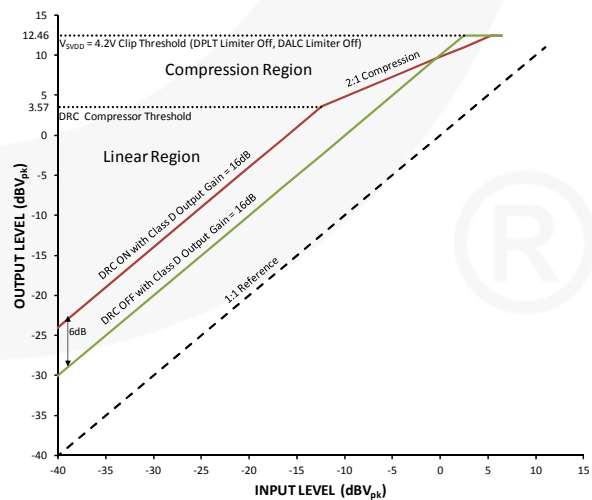

**Figure 26. Gain Boost when Enabling DRC**



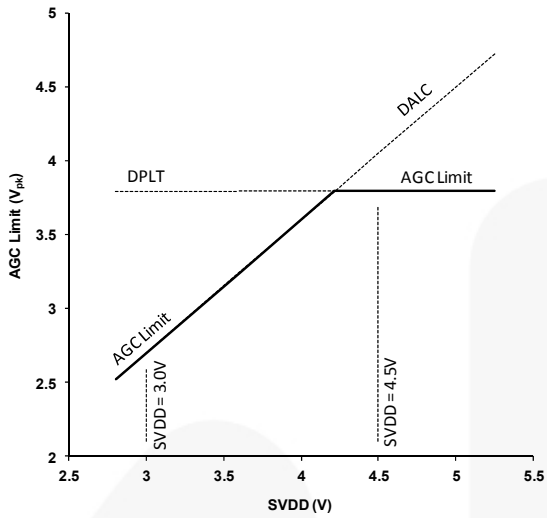

Figure 27. DRC Limiter Threshold when DPLT=3.79 V<sub>pk</sub> (111) and DALC=0.9\*SVDD (001)

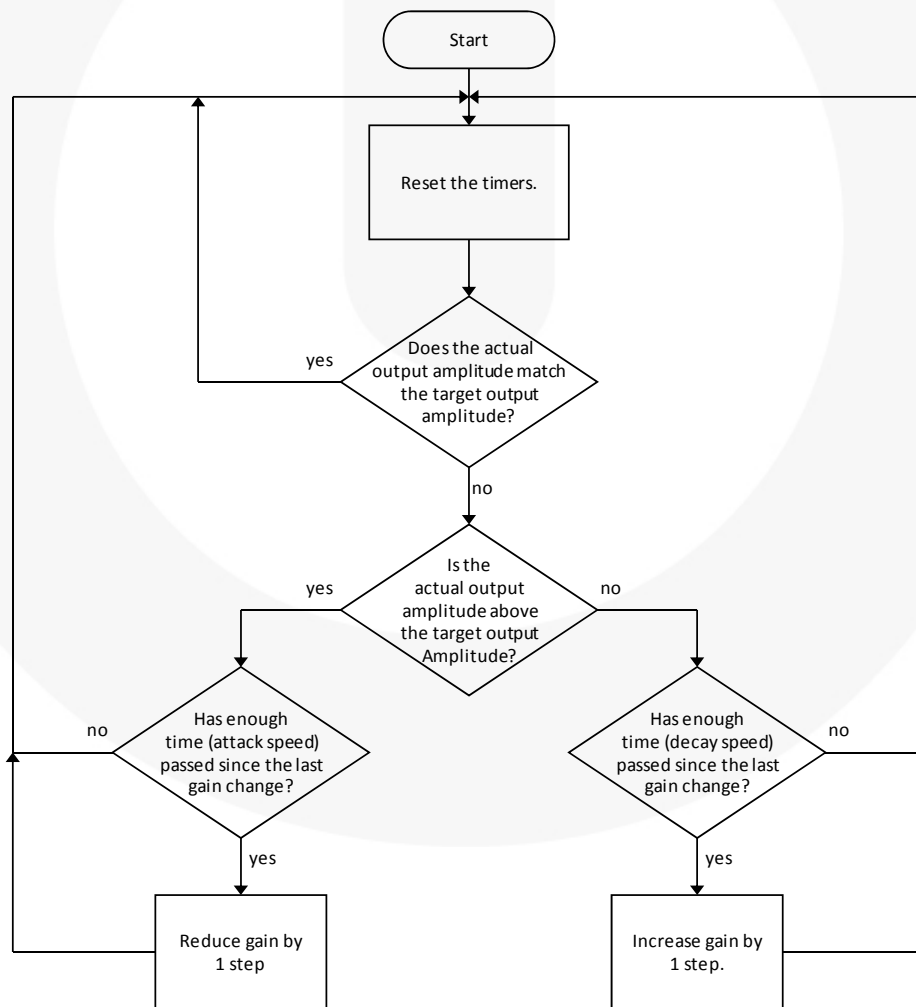

Figure 28. DRC Flowchart

## Speaker Amplifier Noise Gate

The speaker noise gate automatically mutes the speaker amplifier when its input amplitude is below a predetermined noise gate threshold to reduce noise during inactivity. (This function is more useful for speech than music.) The amplitude is measured after the speaker volume control, but before the speaker amplifier block. The speaker noise gate's threshold level is set by the SP\_NG\_RAT register. The amplitude must be less than the noise gate threshold for the hold time determined by the NG\_ATRT register.

The speed at which the volume is reduced is determined by the attack time setting in the NG\_ATRT register. When the volume is reduced by the noise gate, the SP\_ATT register's readback value remains unchanged. An internal register keeps track of the actual volume setting.

If the speaker channel's amplitude goes above the speaker noise gate threshold, the speaker volume is raised back to the SP\_ATT value at a rate determined by the release time setting in the NG\_ATRT register.

To avoid unpredictable behavior, noise gate settings should not be changed while the speaker amplifier is on.

**Table 2. Speaker Volume Change Behavior**

SP_SVOFF	SP_ZCSOFF	Behavior when SP_ATT is Changed
1	1	Volume changes immediately.
1	0	Wait until a zero crossing occurs in the input before changing volume. If a zero crossing does not occur within 200 $\mu$ s, volume is forced to the new setting.
0	1	Volume is ramped to the new setting at a rate of 200 $\mu$ s per step.
0	0	Volume is changed by one step when a zero crossing occurs. If a zero crossing does not occur within 200 $\mu$ s, a step is forced. Only the first zero crossing within 200 $\mu$ s triggers a volume change; volume does not change again until the next 200 $\mu$ s.

## Speaker Volume Ramp and Zero-Crossing Detection

The SP\_SVOFF and SP\_ZCSOFF I<sup>2</sup>C bits control the speaker volume when SP\_ATT is changed.

SP\_SVOFF and SP\_ZCSOFF do not slow down turn-on or turn-off when using the SP\_AMIX, SP\_BMIX, or SRST bits. Thermal, over-current, and DC offset shutdown conditions are not slowed by SP\_SVOFF and SP\_ZCSOFF.

SP\_SVOFF and SP\_ZCSOFF have no effect on DRC and noise gate timing. DRC and noise gate timing have no effect on speaker volume ramp and zero-crossing detection. In the event of a conflict between these systems, the lowest volume setting is chosen.

## I<sup>2</sup>C Control

Writing to and reading from registers is accomplished via the I<sup>2</sup>C interface. The I<sup>2</sup>C protocol requires that one device on the bus initiates and controls all read and write operations. This device is called the "master" device. The master device generates the SCL signal, which is the clock signal for all other devices on the bus. All other devices on the bus are called "slave" devices. The FAB2210 is a slave device. Both the master and slave devices can send and receive data on the bus.

During I<sup>2</sup>C operations, one data bit is transmitted per clock cycle. All I<sup>2</sup>C operations follow a repeating nine clock-cycle pattern that consists of eight bits (one byte) of transmitted data followed by an acknowledge (ACK) or not acknowledge (NACK) from the receiving device.

Note that there are no unused clock cycles during any operation; therefore, there must be no breaks in the stream of data and ACKs/NACKs during data transfers.

For most operations, I<sup>2</sup>C protocol requires the SDA line to remain stable (unmoving) whenever SCL is HIGH; i.e. transitions on the SDA line can only occur when SCL is LOW. The exceptions to this rule are when the master device issues a START or STOP condition. The slave device cannot issue a START or STOP condition.

**START Condition:** This condition occurs when the SDA line transitions from HIGH to LOW while SCL is HIGH. The master device uses this condition to indicate that a data transfer is about to begin.

**STOP Condition:** This condition occurs when the SDA line transitions from LOW to HIGH while SCL is HIGH. The master device uses this condition to signal the end of a data transfer.

**Acknowledge and Not Acknowledge:** When data is transferred to the slave device, the slave device sends an acknowledge (ACK) after receiving every byte of data. The receiving device sends an ACK by pulling SDA LOW for one clock cycle.

When the master device is reading data from the slave device, the master sends an ACK after receiving every byte of data. Following the last byte, a master device sends a "not acknowledge" (NACK) instead of an ACK, followed by a STOP condition. A NACK is indicated by leaving SDA HIGH during the clock after the last byte.

**Slave Address**

Each slave device on the bus must have a unique address so the master can identify which device is sending or receiving data. The FAB2210 slave address is 1001101X binary where "X" is the read/write bit. Master write operations are indicated when X=0. Master read operations are indicated when X=1.

**Writing to and Reading from the FAB2210**

All read and write operations must begin with a START condition generated by the master. After the START condition, the master must immediately send a slave address (7 bits), followed by a read/write bit. If the slave address matches the address of the FAB2210, the FAB2210 sends an ACK after receiving the read/write bit by pulling the SDA line LOW for one clock cycle.

**Setting the Pointer**

For all operations, the pointer stored in the command register must be pointing to the register that is going to be written or read. To change the pointer value in the command register, the read/write bit following the address must be 0. This indicates that the master writes new information into the command register.

After the FAB2210 sends an ACK in response to receiving the address and read/write bit, the master must transmit an appropriate 8-bit pointer value, as explained in the I<sup>2</sup>C Registers section. The FAB2210 sends an ACK after receiving the new pointer data.

The pointer set operation is illustrated in Figure 31 and Figure 32. Any time a pointer set is performed, it must be immediately followed by a read or write operation. The command register retains the current pointer value between operations; therefore, once a register is indicated, subsequent read operations do not require a pointer set cycle. Write operations always require the pointer be reset.

**Reading**

If the pointer is already pointing to the desired register, the master can read from that register by setting the read/write bit (following the slave address) to 1. After sending an ACK, the FAB2210 begins transmitting data during the following clock cycle. The master should respond with a NACK, followed by a STOP condition (see Figure 29).

The master can read multiple bytes by responding to the data with an ACK instead of a NACK and continuing to send SCL pulses, as shown in Figure 30. The FAB2210 increments the pointer by one and sends the data from the next register. The master indicates the last data byte by responding with a NACK, followed by a STOP.

To read from a register other than the one currently indicated by the command register, a pointer to the desired register must be set. Immediately following the pointer set, the master must perform a REPEAT START condition (see Figure 32), which indicates to the FAB2210 that a new operation is about to occur. If the REPEAT START condition does not occur, the FAB2210 assumes that a write is taking place and the selected register is overwritten by the upcoming data on the data bus. After the START condition, the master must again send the device address and read/write bit. This time, the read/write bit must be set to 1 to indicate a read. The rest of the read cycle is the same as described in the previous paragraphs for reading from a preset pointer location.

**Writing**

All writes must be preceded by a pointer set, even if the pointer is already pointing to the desired register.

Immediately following the pointer set, the master must begin transmitting the data to be written. After transmitting each byte of data, the master must release the Serial Data (SDA) line for one clock cycle to allow the FAB2210 to acknowledge receiving the byte. The write operation should be terminated by a STOP condition from the master (see Figure 31).

As with reading, the master can write multiple bytes by continuing to send data. The FAB2210 increments the pointer by one and accepts data for the next register. The master indicates the last data byte by issuing a STOP condition.

### Read / Write Diagrams

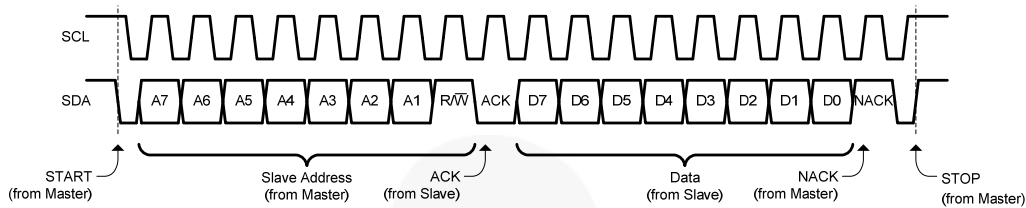

**Figure 29. I<sup>2</sup>C Read**

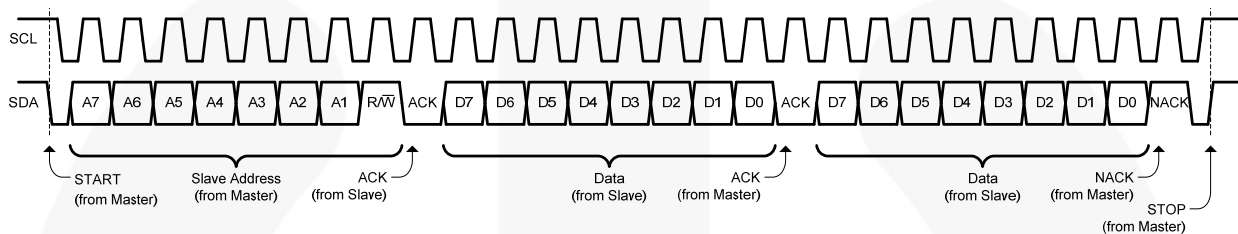

**Figure 30. I<sup>2</sup>C Multiple Byte Read**

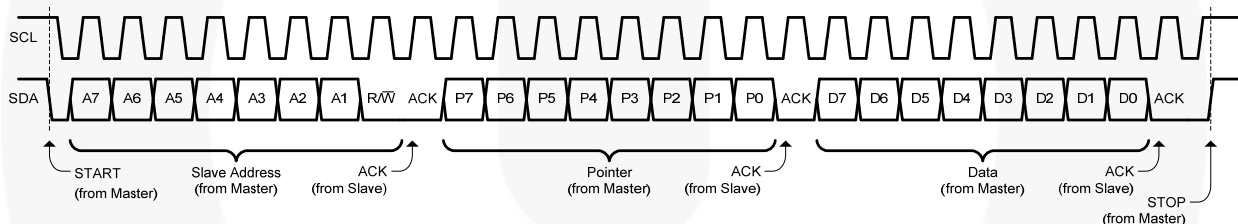

**Figure 31. I<sup>2</sup>C Write**

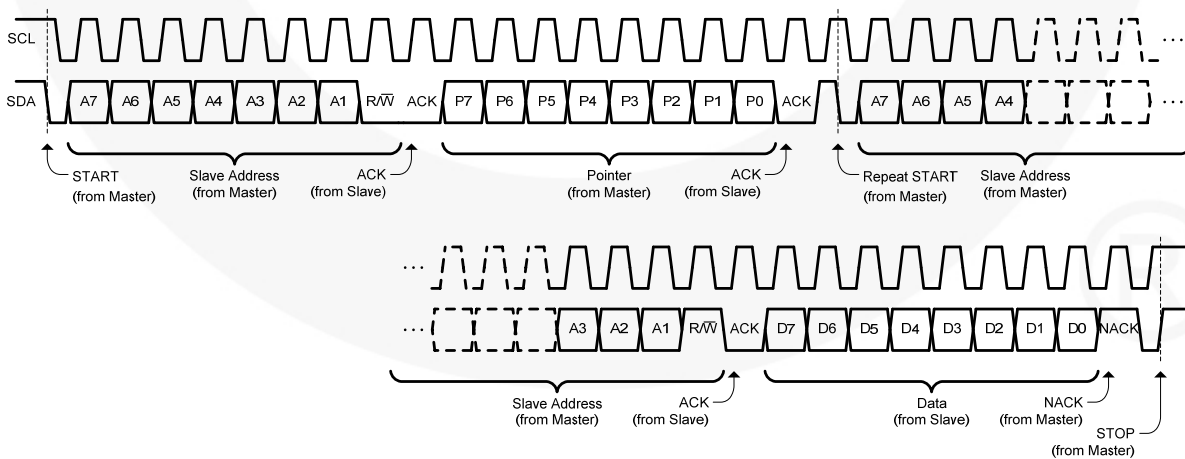

**Figure 32. I<sup>2</sup>C Write Followed by Read**

## Register Map

The I<sup>2</sup>C slave address is 1001101X, where X=0 for write operations and X=1 for read operations.

ADDR	B7	B6	B5	B4	B3	B2	B1	B0
0x15	REVISION_ID[2:0]			RSVD	RSVD	DCERR_TIME[1:0]		0
0x1A	0	SOFTVOL	RSVD					
0x1B	0	DRCMIN[6:0]						
0x1D	MCSSMT[2:0]			SSMT[2:0]			ERC	0
0x80	SRST	0	0	0	0	1	0	0
0x81	DRC_MODE[1:0]		DATRT[1:0]		NG_ATRT[1:0]		0	MODESEL
0x82	DPLT[2:0]			HP_NG_RAT[2:0]			HP_NG_ATT[1:0]	
0x83	0	0	NCLIP	SP_NG_RAT[2:0]			SP_NG_ATT[1:0]	
0x84	VA[3:0]				VB[3:0]			
0x85	DIFA	DIFB	0	0	HP_SVOFF	HP_HIZ	SP_SVOFF	SP_HIZ
0x86	0	SP_ATT[6:0]						
0x87	0	HP_ATT[6:0]						
0x88	OCP_ERR	OTP_ERR	DC_ERR	HP_MONO	HP_AMIX	HP_BMIX	SP_AMIX	SP_BMIX
0xC0	0	DALC[2:0]			HP_GAIN[1:0]		SP_GAIN[1:0]	
0xC1	0	0	0	0	0	HP_ZCSOFF	0	SP_ZCSOFF

### Notes:

- Bits labeled “0” are reserved. Only zeros should be written to these bits.
- Bits labeled “1” are reserved. Only ones should be written to these bits.
- Bits labeled “RSVD” are for testing only. Writing to these bits has no effect. When read, they may return any value.
- Bits and addresses not listed in the register map are for testing only. These bits should never be written. When read, they may return any value.

## Register Descriptions

ADDR	B7	B6	B5	B4	B3	B2	B1	B0
0x15	REVISION_ID[2:0]			RSVD	RSVD	DCERR_TIME[1:0]		0
Default	0	1	1			0	0	0

### REVISION\_ID[2:0]

(read only)

011 = Silicon revision 3.

### DCERR\_TIME[1:0]

DC error time control

11 = DC output detection disabled

10 = 15 ms

01 = 5 ms

00 = 2 ms

ADDR	B7	B6	B5	B4	B3	B2	B1	B0
0x1A	0	SOFTVOL	RSVD					
Default	0	0						

## SOFTVOL

Sets volume ramp speed; sets noise gate release speed when MODESEL=1.

1 = 2 ms / step

0 = 200  $\mu$ s / step

ADDR	B7	B6	B5	B4	B3	B2	B1	B0
0x1B	0	DRCMIN[6:0]						
default	0	0	0	0	0	0	0	0

## DRCMIN[6:0]

Sets the minimum gain that the DRC applies to a signal during attack.

DRCMIN [6:0]	Speaker Volume (dB)	DRCMIN [6:0]	Speaker Volume (dB)	DRCMIN [6:0]	Speaker Volume (dB)	DRCMIN [6:0]	Speaker Volume (dB)
1111111	0.00	1011111	-10.00	0111111	-36.00	0011111	Reserved
1111110	-0.25	1011110	-10.50	0111110	-37.00	0011110	Reserved
1111101	-0.50	1011101	-11.00	0111101	-38.00	0011101	Reserved
1111100	-0.75	1011100	-11.50	0111100	-39.00	0011100	Reserved
1111011	-1.00	1011011	-12.00	0111011	-40.00	0011011	Reserved
1111010	-1.25	1011010	-12.50	0111010	-41.00	0011010	Reserved
1111001	-1.50	1011001	-13.00	0111001	-42.00	0011001	Reserved
1111000	-1.75	1011000	-13.50	0111000	-43.00	0011000	Reserved
1110111	-2.00	1010111	-14.00	0110111	-44.00	0010111	Reserved
1110110	-2.25	1010110	-14.50	0110110	-45.00	0010110	Reserved
1110101	-2.50	1010101	-15.00	0110101	-46.00	0010101	Reserved
1110100	-2.75	1010100	-15.50	0110100	-47.00	0010100	Reserved
1110011	-3.00	1010011	-16.00	0110011	-48.00	0010011	Reserved
1110010	-3.25	1010010	-17.00	0110010	-49.00	0010010	Reserved
1110001	-3.50	1010001	-18.00	0110001	-50.00	0010001	Reserved
1110000	-3.75	1010000	-19.00	0110000	-51.00	0010000	Reserved
1101111	-4.00	1001111	-20.00	0101111	-52.00	0001111	Reserved
1101110	-4.25	1001110	-21.00	0101110	-53.00	0001110	Reserved
1101101	-4.50	1001101	-22.00	0101101	-54.00	0001101	Reserved
1101100	-4.75	1001100	-23.00	0101100	-55.00	0001100	Reserved
1101011	-5.00	1001011	-24.00	0101011	-56.00	0001011	Reserved
1101010	-5.25	1001010	-25.00	0101010	-57.00	0001010	Reserved
1101001	-5.50	1001001	-26.00	0101001	-58.00	0001001	Reserved
1101000	-5.75	1001000	-27.00	0101000	-59.00	0001000	Reserved
1100111	-6.00	1000111	-28.00	0100111	-60.00	0000111	Reserved
1100110	-6.50	1000110	-29.00	0100110	-61.00	0000110	Reserved
1100101	-7.00	1000101	-30.00	0100101	-62.00	0000101	Reserved
1100100	-7.50	1000100	-31.00	0100100	-63.00	0000100	Reserved
1100011	-8.00	1000011	-32.00	0100011	-64.00	0000011	Reserved
1100010	-8.50	1000010	-33.00	0100010	Reserved	0000010	Reserved
1100001	-9.00	1000001	-34.00	0100001	Reserved	0000001	Reserved
1100000	-9.50	1000000	-35.00	0100000	Reserved	0000000	Mute

ADDR	B7	B6	B5	B4	B3	B2	B1	B0
0x1D	MCSSMT[2:0]			SSMT[2:0]			ERC	0
default	1	0	0	0	0	0	1	0

### MCSSMT[2:0]

Sets the master clock spread spectrum modulation percentage. A setting of 000 results in a  $\pm 9.4\%$  modulation. Modulating the master clock does not modulate the class-D output frequency because the triangle wave generator is PLL controlled.

MCSSMT[2:0]	$\pm$ Modulation %
111	10.3
110	9.0
101	8.5
100	6.5
011	37.7
010	21.6
001	15.6
000	9.4

### SSMT[2:0]

Sets the Class-D spread-spectrum modulation percentage. A setting of 000 results in  $\pm 9.4\%$  modulation.

SSMT[2:0]	$\pm$ Modulation %
111	10.3
110	9.0
101	8.5
100	6.5
011	37.7
010	21.6
001	15.6
000	9.4

### ERC

1=Class-D edge rate control on.

0=Class-D edge rate control off.

ADDR	B7	B6	B5	B4	B3	B2	B1	B0
0x80	SRST	0	0	0	0	1	0	0
Default	1	0	0	0	0	1	0	0

## SRST

1=Low-power Standby Mode. All registers are reset to their default values. All I<sup>2</sup>C write commands to bits other than SRST are ignored.

0=Normal operation.

ADDR	B7	B6	B5	B4	B3	B2	B1	B0
0x81	DRC_MODE[1:0]		DATRT[1:0]		NG_ATRT[1:0]		0	MODESEL
default	0	0	0	1	1	1	0	0

## DRC\_MODE[1:0]

Sets the DRC's compression ratio.

DRC_MODE[1:0]	Compression Ratio
11	Reserved
10	Reserved
01	2:1
00	Off

## DATRT[1:0]

Sets the DRC's attack and release times. To avoid extraneous noise, do not change this setting while the speaker amplifier is on.

DATRT[1:0]	Attack Time (ms/step)	Release Time (ms/step)
11	1.0	200
10	0.5	200
01	0.1	200
00	0.1	20

## NG\_ATRT[1:0], MODESEL

Sets the noise gate attack, hold, and release times for the headphone and speaker amplifiers. To avoid extraneous noise, do not change this setting while the headphone or speaker amplifiers are on.

MODESEL	NG_ATRT[1:0]	Attack Time (ms/step)	Release Time (μs/step) SOFTVOL=0	Release Time (μs/step) SOFTVOL=1	Hold Time (ms)
1	11	800	200	2000	44
1	10	400	200	2000	44
1	01	100	200	2000	44
1	00	25	200	2000	44
0	11	800	1400	1400	44
0	10	400	1400	1400	44
0	01	100	1400	1400	44
0	00	25	1400	1400	44

ADDR	B7	B6	B5	B4	B3	B2	B1	B0
0x82	DPLT[2:0]			HP_NG_RAT[2:0]			HP_NG_ATT[1:0]	
Default	0	0	0	1	0	0	0	0



### DPLT[2:0]

Sets the DRC's limiter value, regardless of SVDD supply voltage. Also sets dynamic range compression threshold. To avoid extraneous noise, do not change this setting while the speaker amplifier is on.

DPLT[2:0]	Limiter Voltage ( $V_{pk}$ )	Maximum Power with Sine Wave and 8 $\Omega$ Load (mW)	DRC Threshold at Class-D Output (dB $V_{pk}$ )
111	3.79	900	-12.5
110	3.69	850	-12.7
101	3.58	800	-13.0
100	3.46	750	-13.3
011	3.35	700	-13.5
010	3.22	650	-13.8
001	3.10	600	-14.0
000	No Limit	No Limit	-12.5

### HP\_NG\_RAT[2:0]

Sets the headphone noise gate threshold level. Detection is at the input to the headphone volume block.

HP_NG_RAT[2:0]	Threshold (mV <sub>pk</sub> )
111	Reserved
110	Reserved
101	18
100	12
011	Noise Gate Disabled
010	Noise Gate Disabled
001	Noise Gate Disabled
000	Noise Gate Disabled

### HP\_NG\_ATT[1:0]

Sets the headphone noise gate attenuation level.

HP_NG_ATT[1:0]	Attenuation Level (dB)
11	-6.0
10	-12.0
01	-18.0
00	Mute

ADDR	B7	B6	B5	B4	B3	B2	B1	B0
0x83	0	0	NCLIP	SP_NG_RAT[2:0]			SP_NG_ATT[1:0]	
Default	0	0	0	1	0	0	0	0

### NCLIP

1=Turns on the DRC's clip limiter. Amount of clipping is set by DALC.

0=DRC clip limiter is disabled.

### SP\_NG\_RAT [2:0]

Sets the speaker noise gate threshold. Detection is at the output of the speaker volume block. To avoid extraneous noise, do not change this setting while the speaker amplifier is on.

SP_NG_RAT[2:0]	Threshold (mV <sub>pk</sub> )
111	Reserved
110	Reserved
101	29
100	24
011	14
010	9
001	6
000	Noise Gate Disabled

### SP\_NG\_ATT[1:0]

Sets the speaker noise gate attenuation level.

SP_NG_ATT[1:0]	Attenuation Level (dB)
11	Mute
10	-10
01	-20
00	-40

ADDR	B7	B6	B5	B4	B3	B2	B1	B0
0x84	VA[3:0]				VB[3:0]			
Default	0	0	1	0	0	0	1	0

### VA[3:0], VB[3:0]

Sets pre-amplifier gain.

VA[3:0] or VB[3:0]	Gain (dB)
1111	Reserved
1110	Reserved
1101	Reserved
1100	18.0
1011	15.0
1010	12.0
1001	10.5
1000	9.0

VA[3:0] or VB[3:0]	Gain (dB)
0111	7.5
0110	6.0
0101	4.5
0100	3.0
0011	1.5
0010	0.0
0001	-1.5
0000	-3.0

ADDR	B7	B6	B5	B4	B3	B2	B1	B0
0x85	DIFA	DIFB	0	0	HP_SVOFF	HP_HIZ	SP_SVOFF	SP_HIZ
Default	0	0	0	0	0	1	0	0

**DIFA**

1=INA1 and INA2 are configured as a differential pair.

0=INA1 and INA2 are configured as separate single-ended inputs.

**DIFB**

1=INB1 and INB2 are configured as a differential pair.

0=INB1 and INB2 are configured as separate single-ended inputs.

**HP\_SVOFF**

1=Headphone volume ramping is off.

0=Headphone volume ramping is on.

**HP\_HIZ**

1=Headphone amplifier output impedance is 12.5 k $\Omega$  when amplifier is off and SRST=0.

0=Headphone amplifier output is shorted to DGND when amplifier is off and SRST=0.

**SP\_SVOFF**

1=Speaker volume ramping is off.

0=Speaker volume ramping is on.

**SP\_HIZ**

1=Speaker amplifier output is high impedance when amplifier is off and SRST=0.

0=Speaker amplifier output is connected to SGND with an internal 2 k $\Omega$  resistor when amplifier is off and SRST=0.

ADDR	B7	B6	B5	B4	B3	B2	B1	B0
0x86	0	SP_ATT[6:0]						
Default	0	0	0	0	0	0	0	0

### SP\_ATT[6:0]

Sets the speaker volume.

SP_ATT [6:0]	Speaker Volume (dB)	SP_ATT [6:0]	Speaker Volume (dB)	SP_ATT [6:0]	Speaker Volume (dB)	SP_ATT [6:0]	Speaker Volume (dB)
1111111	0.00	1011111	-10.00	0111111	-36.00	0011111	Reserved
1111110	-0.25	1011110	-10.50	0111110	-37.00	0011110	Reserved
1111101	-0.50	1011101	-11.00	0111101	-38.00	0011101	Reserved
1111100	-0.75	1011100	-11.50	0111100	-39.00	0011100	Reserved
1111011	-1.00	1011011	-12.00	0111011	-40.00	0011011	Reserved
1111010	-1.25	1011010	-12.50	0111010	-41.00	0011010	Reserved
1111001	-1.50	1011001	-13.00	0111001	-42.00	0011001	Reserved
1111000	-1.75	1011000	-13.50	0111000	-43.00	0011000	Reserved
1110111	-2.00	1010111	-14.00	0110111	-44.00	0010111	Reserved
1110110	-2.25	1010110	-14.50	0110110	-45.00	0010110	Reserved
1110101	-2.50	1010101	-15.00	0110101	-46.00	0010101	Reserved
1110100	-2.75	1010100	-15.50	0110100	-47.00	0010100	Reserved
1110011	-3.00	1010011	-16.00	0110011	-48.00	0010011	Reserved
1110010	-3.25	1010010	-17.00	0110010	-49.00	0010010	Reserved
1110001	-3.50	1010001	-18.00	0110001	-50.00	0010001	Reserved
1110000	-3.75	1010000	-19.00	0110000	-51.00	0010000	Reserved
1101111	-4.00	1001111	-20.00	0101111	-52.00	0001111	Reserved
1101110	-4.25	1001110	-21.00	0101110	-53.00	0001110	Reserved
1101101	-4.50	1001101	-22.00	0101101	-54.00	0001101	Reserved
1101100	-4.75	1001100	-23.00	0101100	-55.00	0001100	Reserved
1101011	-5.00	1001011	-24.00	0101011	-56.00	0001011	Reserved
1101010	-5.25	1001010	-25.00	0101010	-57.00	0001010	Reserved
1101001	-5.50	1001001	-26.00	0101001	-58.00	0001001	Reserved
1101000	-5.75	1001000	-27.00	0101000	-59.00	0001000	Reserved
1100111	-6.00	1000111	-28.00	0100111	-60.00	0000111	Reserved
1100110	-6.50	1000110	-29.00	0100110	-61.00	0000110	Reserved
1100101	-7.00	1000101	-30.00	0100101	-62.00	0000101	Reserved
1100100	-7.50	1000100	-31.00	0100100	-63.00	0000100	Reserved
1100011	-8.00	1000011	-32.00	0100011	-64.00	0000011	Reserved
1100010	-8.50	1000010	-33.00	0100010	Reserved	0000010	Reserved
1100001	-9.00	1000001	-34.00	0100001	Reserved	0000001	Reserved
1100000	-9.50	1000000	-35.00	0100000	Reserved	0000000	Mute

ADDR	B7	B6	B5	B4	B3	B2	B1	B0	
0x87	0	HP_ATT[6:0]							
default	0	0	0	0	0	0	0	0	

### HP\_ATT[6:0]

Sets the headphone volume.

HP_ATT [6:0]	Headphone Volume (dB)	HP_ATT [6:0]	Headphone Volume (dB)	HP_ATT [6:0]	Headphone Volume (dB)	HP_ATT [6:0]	Headphone Volume (dB)
1111111	0.00	1011111	-10.00	0111111	-36.00	0011111	Reserved
1111110	-0.25	1011110	-10.50	0111110	-37.00	0011110	Reserved
1111101	-0.50	1011101	-11.00	0111101	-38.00	0011101	Reserved
1111100	-0.75	1011100	-11.50	0111100	-39.00	0011100	Reserved
1111011	-1.00	1011011	-12.00	0111011	-40.00	0011011	Reserved
1111010	-1.25	1011010	-12.50	0111010	-41.00	0011010	Reserved
1111001	-1.50	1011001	-13.00	0111001	-42.00	0011001	Reserved
1111000	-1.75	1011000	-13.50	0111000	-43.00	0011000	Reserved
1110111	-2.00	1010111	-14.00	0110111	-44.00	0010111	Reserved
1110110	-2.25	1010110	-14.50	0110110	-45.00	0010110	Reserved
1110101	-2.50	1010101	-15.00	0110101	-46.00	0010101	Reserved
1110100	-2.75	1010100	-15.50	0110100	-47.00	0010100	Reserved
1110011	-3.00	1010011	-16.00	0110011	-48.00	0010011	Reserved
1110010	-3.25	1010010	-17.00	0110010	-49.00	0010010	Reserved
1110001	-3.50	1010001	-18.00	0110001	-50.00	0010001	Reserved
1110000	-3.75	1010000	-19.00	0110000	-51.00	0010000	Reserved
1101111	-4.00	1001111	-20.00	0101111	-52.00	0001111	Reserved
1101110	-4.25	1001110	-21.00	0101110	-53.00	0001110	Reserved
1101101	-4.50	1001101	-22.00	0101101	-54.00	0001101	Reserved
1101100	-4.75	1001100	-23.00	0101100	-55.00	0001100	Reserved
1101011	-5.00	1001011	-24.00	0101011	-56.00	0001011	Reserved
1101010	-5.25	1001010	-25.00	0101010	-57.00	0001010	Reserved
1101001	-5.50	1001001	-26.00	0101001	-58.00	0001001	Reserved
1101000	-5.75	1001000	-27.00	0101000	-59.00	0001000	Reserved
1100111	-6.00	1000111	-28.00	0100111	-60.00	0000111	Reserved
1100110	-6.50	1000110	-29.00	0100110	-61.00	0000110	Reserved
1100101	-7.00	1000101	-30.00	0100101	-62.00	0000101	Reserved
1100100	-7.50	1000100	-31.00	0100100	-63.00	0000100	Reserved
1100011	-8.00	1000011	-32.00	0100011	-64.00	0000011	Reserved
1100010	-8.50	1000010	-33.00	0100010	Reserved	0000010	Reserved
1100001	-9.00	1000001	-34.00	0100001	Reserved	0000001	Reserved
1100000	-9.50	1000000	-35.00	0100000	Reserved	0000000	Mute

ADDR	B7	B6	B5	B4	B3	B2	B1	B0
0x88	OCP_ERR	OTP_ERR	DC_ERR	HP_MONO	HP_AMIX	HP_BMIX	SP_AMIX	SP_BMIX
Default				0	0	0	0	0

### OCP\_ERR

(Read only)

1=Indicates that the speaker amplifier current limit of  $1.3 A_{PEAK}$  has been exceeded. Speaker amplifier turns off. Bit remains HIGH and amplifier stays off until power or SRST are cycled.

0=Normal operation.

### OTP\_ERR

(Read only)

1=Indicates that the temperature limit of  $150^{\circ}\text{C}$  has been exceeded. Speaker amplifier turns off. Bit remains HIGH and amplifier stays off until temperature falls below thermal shutdown hysteresis (see *Electrical Characteristics*) or power or SRST are cycled.

0=Normal operation.

### DC\_ERR

(Read only)

1=Indicates that the DC voltage across the speaker amplifier terminals has exceeded  $1.5 V_{pk}$ . Speaker amplifier turns off. Bit remains high and amplifier stays off until power or SRST are cycled.

0=Normal operation.

### HP\_MONO, HP\_AMIX, HP\_BMIX

Selects inputs to the headphone amplifiers.

HP_MONO	DIFA	DIFB	HP_AMIX	HP_BMIX	HOUTL	HOUTR
1	1	1	1	1	$(INA1-INA2+INB1-INB2)/2$	Amplifier Off
1	1	1	1	0	$(INA1-INA2)/2$	Amplifier Off
1	1	1	0	1	$(INB1-INB2)/2$	Amplifier Off
1	1	1	0	0	Amplifier Off	Amplifier Off
1	1	0	1	1	$(INA1-INA2+INB1+INB2)/2$	Amplifier Off
1	1	0	1	0	$(INA1-INA2)/2$	Amplifier Off
1	1	0	0	1	$(INB1+INB2)/2$	Amplifier Off
1	1	0	0	0	Amplifier Off	Amplifier Off
1	0	1	1	1	$(INA1+INA2+INB1-INB2)/2$	Amplifier Off
1	0	1	1	0	$(INA1+INA2)/2$	Amplifier Off
1	0	1	0	1	$(INB1-INB2)/2$	Amplifier Off
1	0	1	0	0	Amplifier Off	Amplifier Off
1	0	0	1	1	$(INA1+INA2+INB1+INB2)/2$	Amplifier Off
1	0	0	1	0	$(INA1+INA2)/2$	Amplifier Off
1	0	0	0	1	$(INB1+INB2)/2$	Amplifier Off
1	0	0	0	0	Amplifier Off	Amplifier Off
0	1	1	1	1	$(INA1-INA2+INB1-INB2)$	$(INA1-INA2+INB1-INB2)$
0	1	1	1	0	$(INA1-INA2)$	$(INA1-INA2)$
0	1	1	0	1	$(INB1-INB2)$	$(INB1-INB2)$
0	1	1	0	0	Amplifier Off	Amplifier Off
0	1	0	1	1	$[(INA1-INA2)]+INB1$	$[(INA1-INA2)]+INB2$
0	1	0	1	0	$(INA1-INA2)$	$(INA1-INA2)$
0	1	0	0	1	INB1	INB2
0	1	0	0	0	Amplifier Off	Amplifier Off
0	0	1	1	1	$INA1+[(INB1-INB2)]$	$INA2+[(INB1-INB2)]$
0	0	1	1	0	INA1	INA2
0	0	1	0	1	$(INB1-INB2)$	$(INB1-INB2)$
0	0	1	0	0	Amplifier Off	Amplifier Off
0	0	0	1	1	INA1+ INB1	INA2+INB2
0	0	0	1	0	INA1	INA2
0	0	0	0	1	INB1	INB2
0	0	0	0	0	Amplifier Off	Amplifier Off

## SP\_AMIX, SP\_BMIX

Selects inputs to the speaker amplifier.

DIFA	DIFB	SP_AMIX	SP_BMIX	Speaker Volume Inputs
1	1	1	1	$(INA1-INA2+INB1-INB2)/2$
1	1	1	0	$(INA1-INA2)/2$
1	1	0	1	$(INB1-INB2)/2$
1	1	0	0	Speaker Amplifier Off
1	0	1	1	$(INA1-INA2+INB1+INB2)/2$
1	0	1	0	$(INA1-INA2)/2$
1	0	0	1	$(INB1+INB2)/2$
1	0	0	0	Speaker Amplifier Off
0	1	1	1	$(INA1+INA2+INB1-INB2)/2$
0	1	1	0	$(INA1+INA2)/2$
0	1	0	1	$(INB1-INB2)/2$
0	1	0	0	Speaker Amplifier Off
0	0	1	1	$(INA1+INA2+INB1+INB2)/2$
0	0	1	0	$(INA1+INA2)/2$
0	0	0	1	$(INB1+INB2)/2$
0	0	0	0	Speaker Amplifier Off

ADDR	B7	B6	B5	B4	B3	B2	B1	B0
0xC0	0	DALC[2:0]			HP_GAIN[1:0]		SP_GAIN[1:0]	
Default	0	0	0	1	0	0	0	0

## DALC[2:0]

Sets the DRC's clip limiter. To avoid extraneous noise, do not change this setting while the speaker amplifier is on.

DALC[2:0]	SVDD Fraction (V/V)	THD with 1 kHz Sine Wave (%) ( $V_{SVDD}=3.7\text{ V}$ , $8\ \Omega$ Load)
111	Reserved	Reserved
110	Reserved	Reserved
101	Reserved	Reserved
100	1.15	10
011	1.00	4.9
010	0.95	3
001	0.90	1
000	Reserved	Reserved



### HP\_GAIN[1:0]

Sets the gain of the headphone amplifier block.

HP_GAIN[1:0]	Headphone Amplifier Gain (dB)
11	6.0
10	3.0
01	1.5
00	0

### SP\_GAIN[1:0]

Sets the speaker amplifier gain.

SP_GAIN[1:0]	Speaker Amplifier Gain (dB)
11	Reserved
10	24
01	20
00	16

ADDR	B7	B6	B5	B4	B3	B2	B1	B0
0xC1	0	0	0	0	0	HP_ZCSOFF	0	SP_ZCSOFF
Default	0	0	0	0	0	1	0	1

### SP\_ZCSOFF

1=Speaker volume zero-crossing detection is off.

0=Speaker volume zero-crossing detection is on.

### HP\_ZCSOFF

1=Headphone volume zero-crossing detection is off.

0=Headphone volume zero-crossing detection is on.

## Applications Information

### Layout Considerations

General layout and supply bypassing play a major role in analog performance and thermal characteristics. Fairchild provides a demonstration board to guide layout and aid device evaluation. A graphical user interface software program allows control of the I<sup>2</sup>C registers to optimize the performance of the device in various applications. For the best results, follow the steps and recommended routing rules listed below.

### Recommended Routing/Layout Rules

- Do not run analog and digital signals in parallel.
- Use separate analog and digital power planes to supply power.
- Traces should run on top of the ground plane at all times.
- No trace should run over ground/power splits.
- Avoid routing at 90-degree angles.
- Place bypass capacitors within 2.54 mm (0.1 inches) of the device power pin.
- Minimize all trace lengths to reduce series inductance.

## Physical Dimensions

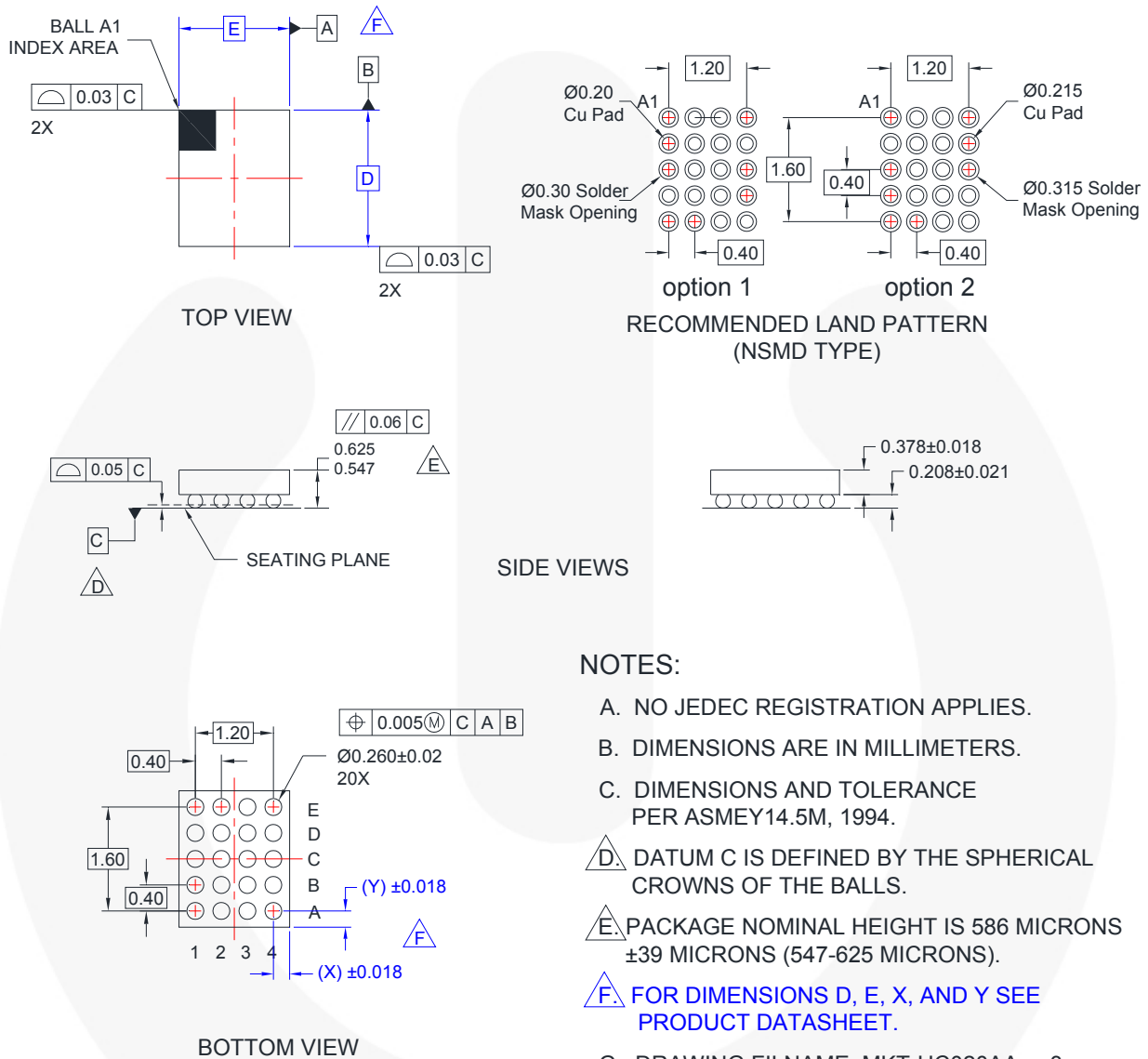

Figure 33. 20-Bump, Wafer-Level Chip-Scale Package (WLCSP), 0.4 mm Pitch

## External Product Dimensions

Product	D	E	X	Y
FAB2210UCX	1.96 mm	1.96 mm	0.38 mm	0.18 mm

Package drawings are provided as a service to customers considering Fairchild components. Drawings may change in any manner without notice. Please note the revision and/or date on the drawing and contact a Fairchild Semiconductor representative to verify or obtain the most recent version. Package specifications do not expand Fairchild's worldwide terms and conditions, specifically the warranty therein, which covers Fairchild products.

Always visit Fairchild Semiconductors online packaging area for the most recent packaging drawings and tape and reel specifications: <http://www.fairchildsemi.com/packaging/>.



**TRADEMARKS**

The following includes registered and unregistered trademarks and service marks, owned by Fairchild Semiconductor and/or its global subsidiaries, and is not intended to be an exhaustive list of all such trademarks.

- |  |  |  |   |
|--|--|--|---|
| 2Cool™   | F-PFS™   | PowerTrench®   | The Power Franchise®  |
| AccuPower™   | FRFET®   | PowerXS™   | <b>the power franchise</b>  |
| AX-CAP™*   | Global Power Resource™                         | Programmable Active Droop™   | TinyBoost™  |
| BitSIC™  | GreenBridge™                                   | QFET®  | TinyBuck™   |
| Build it Now™  | Green FPS™                                     | QS™  | TinyCalc™   |
| CorePLUS™  | Green FPS™ e-Series™                           | Quiet Series™  | TinyLogic®  |
| CorePOWER™   | Gmax™  | RapidConfigure™  | TINYOPTO™   |
| CROSSVOLT™   | GTO™   |  ™                | TinyPower™  |
| CTL™   | IntelliMAX™                                    | Saving our world, 1mW/W/kW at a time™  | TinyPWM™  |
| Current Transfer Logic™  | ISOPLANAR™                                     | SignalWise™  | TinyWire™   |
| DEUXPEED®  | Making Small Speakers Sound Louder and Better™ | SmartMax™  | TranSIC™  |
| Dual Cool™   | MegaBuck™                                      | SMART START™   | TriFault Detect™  |
| EcoSPARK®  | MICROCOUPLER™                                  | Solutions for Your Success™  | TRUECURRENT®*   |
| EfficientMax™  | MicroFET™                                      | SPM®   | µSerDes™  |
| ESBC™  | MicroPak™                                      | STEALTH™   |  SerDes™ |
|  Fairchild® | MicroPak2™                                     | SuperFET®  | UHC®  |
| Fairchild Semiconductor®   | MillerDrive™                                   | SuperSOT™-3  | Ultra FRFET™  |
| FACT Quiet Series™   | MotionMax™                                     | SuperSOT™-6  | UniFET™   |
| FACT®  | mWSaver™                                       | SuperSOT™-8  | VCX™  |
| FAST®  | OptoHi™  | SupreMOS®  | VisualMax™  |
| FastvCore™   | OPTOLOGIC®                                     | SyncFET™   | VoltagePlus™  |
| FETBench™  | OPTOPLANAR®                                    | Sync-Lock™   | XS™   |
| FlashWriter®*  |  |  SYSTEM GENERAL®* |   |
| FPS™   |  |  |   |

\* Trademarks of System General Corporation, used under license by Fairchild Semiconductor.

**DISCLAIMER**

FAIRCHILD SEMICONDUCTOR RESERVES THE RIGHT TO MAKE CHANGES WITHOUT FURTHER NOTICE TO ANY PRODUCTS HEREIN TO IMPROVE RELIABILITY, FUNCTION, OR DESIGN. FAIRCHILD DOES NOT ASSUME ANY LIABILITY ARISING OUT OF THE APPLICATION OR USE OF ANY PRODUCT OR CIRCUIT DESCRIBED HEREIN; NEITHER DOES IT CONVEY ANY LICENSE UNDER ITS PATENT RIGHTS, NOR THE RIGHTS OF OTHERS. THESE SPECIFICATIONS DO NOT EXPAND THE TERMS OF FAIRCHILD'S WORLDWIDE TERMS AND CONDITIONS, SPECIFICALLY THE WARRANTY THEREIN, WHICH COVERS THESE PRODUCTS.

**LIFE SUPPORT POLICY**

FAIRCHILD'S PRODUCTS ARE NOT AUTHORIZED FOR USE AS CRITICAL COMPONENTS IN LIFE SUPPORT DEVICES OR SYSTEMS WITHOUT THE EXPRESS WRITTEN APPROVAL OF FAIRCHILD SEMICONDUCTOR CORPORATION.

As used herein:

1. Life support devices or systems are devices or systems which, (a) are intended for surgical implant into the body or (b) support or sustain life, and (c) whose failure to perform when properly used in accordance with instructions for use provided in the labeling, can be reasonably expected to result in a significant injury of the user.
2. A critical component in any component of a life support, device, or system whose failure to perform can be reasonably expected to cause the failure of the life support device or system, or to affect its safety or effectiveness.

**ANTI-COUNTERFEITING POLICY**

Fairchild Semiconductor Corporation's Anti-Counterfeiting Policy. Fairchild's Anti-Counterfeiting Policy is also stated on our external website, [www.fairchildsemi.com](http://www.fairchildsemi.com), under Sales Support.

Counterfeiting of semiconductor parts is a growing problem in the industry. All manufacturers of semiconductor products are experiencing counterfeiting of their parts. Customers who inadvertently purchase counterfeit parts experience many problems such as loss of brand reputation, substandard performance, failed applications, and increased cost of production and manufacturing delays. Fairchild is taking strong measures to protect ourselves and our customers from the proliferation of counterfeit parts. Fairchild strongly encourages customers to purchase Fairchild parts either directly from Fairchild or from Authorized Fairchild Distributors who are listed by country on our web page cited above. Products customers buy either from Fairchild directly or from Authorized Fairchild Distributors are genuine parts, have full traceability, meet Fairchild's quality standards for handling and storage and provide access to Fairchild's full range of up-to-date technical and product information. Fairchild and our Authorized Distributors will stand behind all warranties and will appropriately address any warranty issues that may arise. Fairchild will not provide any warranty coverage or other assistance for parts bought from Unauthorized Sources. Fairchild is committed to combat this global problem and encourage our customers to do their part in stopping this practice by buying direct or from authorized distributors.

**PRODUCT STATUS DEFINITIONS**

**Definition of Terms**

Datasheet Identification	Product Status	Definition
Advance Information	Formative / In Design	Datasheet contains the design specifications for product development. Specifications may change in any manner without notice.
Preliminary	First Production	Datasheet contains preliminary data; supplementary data will be published at a later date. Fairchild Semiconductor reserves the right to make changes at any time without notice to improve design.
No Identification Needed	Full Production	Datasheet contains final specifications. Fairchild Semiconductor reserves the right to make changes at any time without notice to improve the design.
Obsolete	Not In Production	Datasheet contains specifications on a product that is discontinued by Fairchild Semiconductor. The datasheet is for reference information only.

Rev. I62

ON Semiconductor and  are trademarks of Semiconductor Components Industries, LLC dba ON Semiconductor or its subsidiaries in the United States and/or other countries. ON Semiconductor owns the rights to a number of patents, trademarks, copyrights, trade secrets, and other intellectual property. A listing of ON Semiconductor's product/patent coverage may be accessed at [www.onsemi.com/site/pdf/Patent-Marking.pdf](http://www.onsemi.com/site/pdf/Patent-Marking.pdf). ON Semiconductor reserves the right to make changes without further notice to any products herein. ON Semiconductor makes no warranty, representation or guarantee regarding the suitability of its products for any particular purpose, nor does ON Semiconductor assume any liability arising out of the application or use of any product or circuit, and specifically disclaims any and all liability, including without limitation special, consequential or incidental damages. Buyer is responsible for its products and applications using ON Semiconductor products, including compliance with all laws, regulations and safety requirements or standards, regardless of any support or applications information provided by ON Semiconductor. "Typical" parameters which may be provided in ON Semiconductor data sheets and/or specifications can and do vary in different applications and actual performance may vary over time. All operating parameters, including "Typicals" must be validated for each customer application by customer's technical experts. ON Semiconductor does not convey any license under its patent rights nor the rights of others. ON Semiconductor products are not designed, intended, or authorized for use as a critical component in life support systems or any FDA Class 3 medical devices or medical devices with a same or similar classification in a foreign jurisdiction or any devices intended for implantation in the human body. Should Buyer purchase or use ON Semiconductor products for any such unintended or unauthorized application, Buyer shall indemnify and hold ON Semiconductor and its officers, employees, subsidiaries, affiliates, and distributors harmless against all claims, costs, damages, and expenses, and reasonable attorney fees arising out of, directly or indirectly, any claim of personal injury or death associated with such unintended or unauthorized use, even if such claim alleges that ON Semiconductor was negligent regarding the design or manufacture of the part. ON Semiconductor is an Equal Opportunity/Affirmative Action Employer. This literature is subject to all applicable copyright laws and is not for resale in any manner.

## PUBLICATION ORDERING INFORMATION

### LITERATURE FULFILLMENT:

Literature Distribution Center for ON Semiconductor  
19521 E. 32nd Pkwy, Aurora, Colorado 80011 USA  
**Phone:** 303-675-2175 or 800-344-3860 Toll Free USA/Canada  
**Fax:** 303-675-2176 or 800-344-3867 Toll Free USA/Canada  
**Email:** [orderlit@onsemi.com](mailto:orderlit@onsemi.com)

**N. American Technical Support:** 800-282-9855 Toll Free  
USA/Canada  
**Europe, Middle East and Africa Technical Support:**  
Phone: 421 33 790 2910  
**Japan Customer Focus Center**  
Phone: 81-3-5817-1050

**ON Semiconductor Website:** [www.onsemi.com](http://www.onsemi.com)  
**Order Literature:** <http://www.onsemi.com/orderlit>  
For additional information, please contact your local  
Sales Representative