

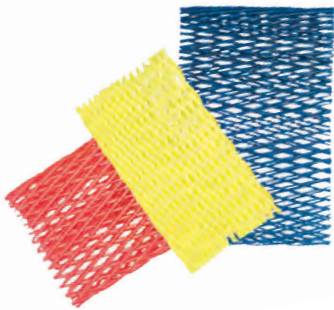

CAPS, PLUGS & NETTING



	TAPERED CAPS & PLUGS.....	24-27
	PUSH-FIT CAPS.....	28-32
	PUSH-FIT CAPS FOR THREADS.....	33-38
	THREADED CAPS.....	39-40
	PUSH-FIT PLUGS.....	41-44
	SHEET METAL PLUGS.....	45-46
	CONNECTOR PLUGS.....	47
	PACKAGING TUBE PLUGS.....	48
	PUSH-FIT PLUGS FOR THREADS.....	49-52
	FLUID ABSORPTION PLUGS.....	53
	THREADED PLUGS.....	54-61
	PROPANE VALVE PRODUCT CAPS & PLUGS.....	62
	NETTING.....	63
	APPLICATION WIZARDS.....	64-65

CAPS, PLUGS & NETTING

CAPS, PLUGS & NETTING

TAPERED CAPS & PLUGS

Numbered/GP Series Tapered Caps or Plugs

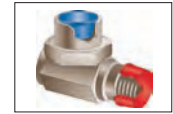
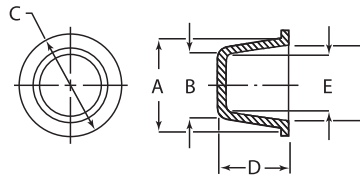

Specifications:

- Material: Low-Density Polyethylene
- Color: See Table

Features:

- The tapered design allows the part to plug multiple inner diameters or cap multiple outside diameters
- Protects against damage, dirt, moisture and corrosion during storage and shipping
- GP series parts have a heavy duty design which includes a rugged wall and seal rings for maximum protection

To Assure Proper Fit:

Plugs

Plug dimension "A" should be approx. 1% larger than the inner diameter of the part.
Minimum of .020"

Caps

Cap dimension "E" should be approx. 1% smaller than the outside diameter of the part.
Minimum of .020"

See pages 64 and 65 for Application Wizards

Item No.	Use as a Plug						Use as a Cap						Bulk Pack Qty	
	Blue	Red	A		B		C		D		E			F
			in	mm	in	mm	in	mm	in	mm	in	mm	in	mm
001A	—	0.180	4.57	0.115	2.92	0.313	7.94	0.406	10.32	0.051	1.30	0.118	3.00	5000
001-SA	—	0.180	4.57	0.138	3.51	0.310	7.87	0.250	6.35	0.051	1.30	0.118	3.00	5000
1000A	1000B	0.205	5.21	0.145	3.68	0.410	10.41	0.410	10.41	0.079	2.01	0.150	3.81	5000
002A	002C	0.240	6.10	0.175	4.45	0.375	9.53	0.375	9.53	0.109	2.77	0.175	4.45	5000
003A	—	0.268	6.81	0.209	5.31	0.375	9.53	0.375	9.53	0.127	3.23	0.193	4.90	5000
003WA	—	0.274	6.95	0.200	5.08	0.594	15.08	0.375	9.53	0.150	3.81	0.220	5.58	5000
004A	004B	0.275	6.99	0.209	5.31	0.438	11.11	0.375	9.53	0.150	3.81	0.209	5.31	5000
005A	005B	0.302	7.67	0.240	6.10	0.469	11.91	0.375	9.53	0.175	4.45	0.240	6.10	5000
—	GP607A	0.325	8.26	0.292	7.42	0.531	13.49	0.375	9.53	0.215	5.46	0.250	6.35	5000
—	50222	0.335	8.50	0.185	4.70	0.461	11.70	0.886	22.50	0.098	2.50	0.224	5.70	10000
006A	006B	0.335	8.51	0.265	6.73	0.469	11.91	0.375	9.53	0.204	5.18	0.275	6.99	5000
007A	007B	0.365	9.27	0.300	7.62	0.531	13.49	0.375	9.53	0.234	5.94	0.301	7.65	5000
007WA	—	0.365	9.27	0.300	7.62	0.680	17.27	0.375	9.53	0.234	5.94	0.301	7.65	5000
007SA	—	0.365	9.27	0.330	8.38	0.500	12.70	0.219	5.56	0.266	6.76	0.301	7.65	5000
—	GP610A	0.389	9.88	0.320	8.12	0.563	14.29	0.438	11.11	0.212	5.38	0.285	7.23	5000
008A	008C	0.398	10.11	0.330	8.38	0.563	14.29	0.375	9.53	0.275	6.99	0.330	8.38	5000
009A	009C	0.428	10.87	0.360	9.14	0.594	15.08	0.375	9.53	0.299	7.59	0.365	9.27	5000
010A	010B	0.460	11.68	0.390	9.91	0.625	15.88	0.393	10.0	0.325	8.26	0.396	10.06	5000
—	10750	0.465	11.80	0.394	10.00	0.591	15.00	0.374	9.50	0.335	8.50	0.394	10.00	10000
011A	011B	0.485	12.32	0.420	10.67	0.594	15.08	0.375	9.53	0.356	9.04	0.421	10.69	5000
—	GP617A	0.501	12.72	0.437	11.09	0.647	16.43	0.438	11.11	0.352	8.94	0.420	10.66	4000
012A	012E	0.512	13.00	0.447	11.35	0.625	15.88	0.406	10.32	0.385	9.78	0.448	11.38	5000
—	10421	0.520	13.20	0.445	11.30	0.669	17.00	0.433	11.00	0.386	9.80	0.457	11.60	10000
013A	013C	0.547	13.89	0.490	12.45	0.719	18.26	0.500	12.70	0.409	10.39	0.485	12.32	5000
—	12421	0.551	14.00	0.441	11.20	0.689	17.50	0.728	18.50	0.362	9.20	0.476	12.10	5000
013SPA	—	0.545	13.84	0.478	12.14	0.719	18.26	0.313	7.94	0.410	10.41	0.480	12.19	5000
013WA	—	0.547	13.89	0.478	12.14	0.875	22.23	0.500	12.70	0.409	10.39	0.485	12.32	7000
014A	014C	0.568	14.43	0.500	12.70	0.750	19.05	0.438	11.11	0.435	11.05	0.503	12.78	5000
1015A	—	0.576	14.63	0.500	12.70	0.720	18.29	0.470	11.94	0.440	11.18	0.516	13.11	5000
—	12901	0.583	14.80	0.472	12.00	0.689	17.50	0.433	11.00	0.413	10.50	0.472	12.00	5000
—	015A	0.594	15.09	0.504	12.80	0.728	18.49	0.949	24.10	0.421	10.69	0.520	13.21	4000
—	10438	0.602	15.30	0.535	13.60	0.748	19.00	0.441	11.20	0.476	12.10	0.539	13.70	5000
1020A	—	0.612	15.54	0.554	14.07	0.750	19.05	0.340	8.64	0.490	12.45	0.551	14.00	5000
016A	016D	0.620	15.75	0.531	13.49	0.750	19.05	0.500	12.70	0.468	11.89	0.555	14.10	7500
—	10342	0.630	16.00	0.559	14.20	0.748	19.00	0.476	12.10	0.500	12.70	0.567	14.40	5000
017A	017D	0.634	16.10	0.550	13.97	0.781	19.84	0.500	12.70	0.485	12.32	0.568	14.43	7500
—	10424	0.669	17.00	0.579	14.70	0.811	20.60	0.500	12.70	0.520	13.20	0.606	15.40	5000
018A	018E	0.675	17.15	0.580	14.99	0.875	22.23	0.531	13.49	0.520	13.21	0.605	15.37	5000
1025A	—	0.694	17.63	0.669	16.99	0.750	19.05	0.220	5.59	0.613	15.57	0.638	16.21	5000
020A	020D	0.695	17.65	0.610	15.49	0.844	21.43	0.500	12.70	0.549	13.94	0.634	16.10	6000
021A	021B	0.728	18.49	0.641	16.28	0.875	22.23	0.500	12.70	0.575	14.61	0.665	16.89	5000
022A	022C	0.754	19.15	0.675	17.15	0.875	22.23	0.625	15.88	0.615	15.62	0.690	17.53	4000
—	GP628A	0.757	19.22	0.658	16.71	0.921	23.39	0.648	16.45	0.538	13.66	0.662	16.81	5700
—	110197	0.764	19.40	0.673	17.10	0.866	22.00	0.512	13.00	0.610	15.50	0.701	17.80	6500
—	11088	0.772	19.60	0.697	17.70	0.874	22.20	0.500	12.70	0.598	15.20	0.681	17.30	5000
023A	023C	0.785	19.94	0.690	17.53	0.938	23.81	0.625	15.88	0.625	15.88	0.724	18.39	4000
—	12197	0.795	20.20	0.677	17.20	0.953	24.20	0.709	18.00	0.610	15.50	0.709	18.00	4000
024A	—	0.805	20.45	0.750	19.05	0.860	21.84	0.190	4.83	0.688	17.48	0.743	18.87	7500
026A	026C	0.825	20.96	0.725	18.42	1.000	25.40	0.500	12.70	0.662	16.81	0.760	19.30	4000
026-LA	—	0.825	20.96	0.725	18.42	0.970	24.64	0.590	14.99	0.662	16.81	0.760	19.30	8000
027A	027E	0.848	21.54	0.750	19.05	1.031	26.19	0.625	15.88	0.686	17.42	0.777	19.74	7000
—	GP632A	0.851	21.61	0.766	19.45	1.045	26.54	0.625	15.88	0.609	15.46	0.740	18.79	4200
—	027AA	0.882	22.40	0.768	19.50	1.039	26.40	0.787	20.00	0.701	17.80	0.823	20.90	3000
028A	028D	0.910	23.11	0.802	20.37	1.094	27.78	0.750	19.05	0.725	18.42	0.846	21.49	5000
029A	029D	0.931	23.65	0.820	20.83	1.125	28.58	0.625	15.88	0.754	19.15	0.868	22.05	5500
030A	030C	0.973	24.71	0.856	21.74	1.125	28.58	0.750	19.05	0.768	19.51	0.906	23.01	4500

(Continued on next page >)



TAPERED CAPS & PLUGS

Numbered/GP Series Tapered Caps or Plugs (continued)

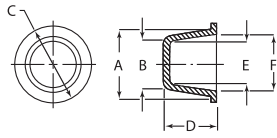

To Assure Proper Fit:

Plugs Plug dimension "A" should be approx. 1% larger than the inner diameter of the part. Minimum of .020"

Caps Cap dimension "E" should be approx. 1% smaller than the outside diameter of the part. Minimum of .020"

See pages 64 and 65 for Application Wizards

Table with columns for Item No., Use as a Plug (A, B, C, D), Use as a Cap (E, F), and Bulk Pack Qty. Rows include various part numbers like 073A, 074A, etc.

TAPERED CAPS & PLUGS



LF Series
Wide Flange Caps or Plugs

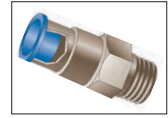
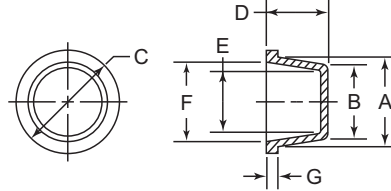

Specifications:

- Material: Low-Density Polyethylene
- Color: See Table

Features:

- Wider flange assures added protection on bearing surfaces
- Wider flange keeps plug from being accidentally pushed down through the mating part
- The tapered design allows the part to plug multiple inner diameters or cap multiple outside diameters

To Assure Proper Fit:

Plugs	Caps
Plug dimension "A" should be approx. 1% larger than the inner diameter of the part. Minimum of .020"	Cap dimension "E" should be approx. 1% smaller than the outside diameter of the part. Minimum of .020"

tem No.	Use as a Plug				Use as a Cap							Color	Bulk Pack Qty			
	A		B		C		D		E		F			G		
	in	mm	in	mm	in	mm	in	mm	in	mm	in	mm	in	mm		
LF2A	0.240	6.10	0.173	4.39	0.562	14.27	0.465	11.81	0.111	2.82	0.177	4.50	0.090	2.29	Blue	5500
LF3A	0.290	7.37	0.236	5.99	0.485	12.32	0.402	10.21	0.146	3.71	0.245	6.22	0.090	2.29	Blue	5000
LF5A	0.374	9.50	0.307	7.80	0.724	18.39	0.404	10.26	0.248	6.30	0.303	7.70	0.030	0.76	Red	5000
LF6A	0.418	10.62	0.367	9.32	0.740	18.80	0.402	10.21	0.298	7.57	0.354	8.99	0.090	2.29	Blue	5000
LF7A	0.447	11.35	0.397	10.08	0.795	20.19	0.402	10.21	0.328	8.33	0.383	9.73	0.090	2.29	Blue	5000
LF8A	0.475	12.07	0.427	10.85	0.812	20.62	0.402	10.21	0.356	9.04	0.422	10.72	0.090	2.29	Blue	4750
12433	0.484	12.30	0.421	10.70	0.866	22.00	0.404	10.26	0.358	9.10	0.421	10.70	0.030	0.76	Red	10000
LF9A	0.509	12.93	0.440	11.18	0.820	20.83	0.465	11.81	0.375	9.53	0.450	11.43	0.090	2.29	Blue	7500
10420	0.520	13.20	0.445	11.30	1.142	29.00	0.463	11.76	0.386	9.80	0.457	11.60	0.030	0.76	Red	10000
LF10A	0.547	13.89	0.481	12.22	0.870	22.10	0.460	11.68	0.409	10.39	0.493	12.52	0.090	2.29	Blue	7000
12434	0.610	15.50	0.531	13.50	1.181	30.00	0.404	10.26	0.449	11.40	0.520	13.20	0.030	0.76	Red	5000
LF11A	0.616	15.65	0.530	13.46	0.940	23.88	0.470	11.94	0.470	11.94	0.570	14.48	0.090	2.29	Blue	5000
LF11XA	0.631	16.03	0.565	14.35	0.950	24.13	0.491	12.47	0.500	12.70	0.580	14.73	0.090	2.29	Blue	5000
LF12A	0.659	16.74	0.580	14.99	0.983	24.97	0.527	13.39	0.518	13.16	0.605	15.37	0.090	2.29	Blue	4500
18351	0.665	16.90	0.579	14.70	1.000	25.40	0.545	13.84	0.520	13.20	0.606	15.40	0.045	1.14	Red	6000
LF12XA	0.687	17.45	0.610	15.49	1.031	26.19	0.527	13.39	0.548	13.92	0.635	16.13	0.090	2.29	Blue	4500
LF13XA	0.710	18.03	0.655	16.64	1.062	26.97	0.528	13.41	0.585	14.86	0.647	16.43	0.090	2.29	Yellow	4000
LF13A	0.725	18.42	0.628	15.95	1.062	26.97	0.528	13.41	0.558	14.17	0.667	16.94	0.090	2.29	Yellow	5000
LF15A	0.775	19.69	0.690	17.53	1.125	28.58	0.559	14.20	0.620	15.75	0.721	18.31	0.090	2.29	Blue	3500
12435	0.787	20.00	0.689	17.50	1.374	34.90	0.608	15.44	0.634	16.10	0.728	18.50	0.045	1.14	Red	3000
LF15XA	0.812	20.62	0.725	18.42	1.140	28.96	0.580	14.99	0.662	16.81	0.765	19.43	0.090	2.29	Blue	3000
18356	0.846	21.50	0.752	19.10	1.500	38.10	0.608	15.44	0.693	17.60	0.783	19.90	0.045	1.14	Red	2500
LF16A	0.870	22.10	0.755	19.18	1.185	30.10	0.580	14.99	0.693	17.60	0.808	20.52	0.090	2.29	Blue	3000
LF17A	0.920	23.37	0.820	20.83	1.250	31.75	0.621	15.77	0.741	18.82	0.865	21.97	0.090	2.29	Blue	2300
LF18A	0.975	24.77	0.867	22.02	1.281	32.54	0.650	16.51	0.805	20.45	0.913	23.19	0.090	2.29	Blue	4000
12436	0.984	25.00	0.862	21.90	1.890	48.00	0.734	18.64	0.744	18.90	0.866	22.00	0.045	1.14	Red	1500
LF19A	1.020	25.90	0.950	24.13	1.344	34.13	0.715	18.16	0.875	22.22	0.957	24.30	0.090	2.29	Blue	1500
18357	1.091	27.70	0.972	24.70	1.500	38.10	0.797	20.24	0.913	23.20	1.028	26.10	0.045	1.14	Red	1500
LF20A	1.105	28.07	0.984	24.99	1.437	36.50	0.746	18.95	0.920	23.37	1.040	26.42	0.090	2.29	Blue	3000
LF21A	1.323	33.60	1.197	30.40	1.862	47.29	0.643	16.33	1.094	27.79	1.209	30.71	0.045	1.14	Red	1400
18360	1.354	34.40	1.224	31.10	1.874	47.60	0.797	20.24	1.173	29.80	1.291	32.80	0.045	1.14	Red	1000
LF22A	1.382	35.10	1.237	31.42	1.687	42.85	0.746	18.95	1.167	29.64	1.312	33.32	0.090	2.29	Blue	2000
LF23XA	1.466	37.24	1.312	33.32	1.845	46.86	0.775	19.69	1.250	31.75	1.425	36.20	0.120	3.05	Blue	1700
LF24A	1.604	40.74	1.450	36.83	1.938	49.23	0.745	18.92	1.380	35.05	1.550	39.37	0.120	3.05	Blue	1500
LF26A	1.764	44.81	1.630	41.40	2.252	57.20	0.784	19.91	1.563	39.70	1.693	43.00	0.035	0.90	Red	700
LF28A	1.890	48.01	1.730	43.94	2.312	58.72	0.745	18.92	1.650	41.91	1.825	46.36	0.120	3.05	Blue	1100
LF30A	2.043	51.89	1.858	47.19	2.835	72.01	1.004	25.50	1.752	44.50	1.917	48.69	0.059	1.50	Red	400
LF32A	2.075	52.71	1.902	48.31	2.500	63.50	1.059	26.90	1.823	46.30	1.996	50.70	0.059	1.50	Red	1000
LF34A	2.130	54.10	2.028	51.51	2.626	66.70	0.768	19.50	1.953	49.61	2.047	51.99	0.039	1.00	Red	500
LF36A	2.402	61.01	2.146	54.51	3.012	76.50	1.024	26.00	2.055	52.20	2.323	59.00	0.039	1.00	Red	300
LF38A	2.614	66.40	2.441	62.00	3.267	83.00	1.152	29.26	2.323	59.00	2.531	64.30	0.050	1.27	Red	250

FREE SAMPLES

See our full range of Masking Solutions on page 66

MASKING PLUGS

Temperature protection up to **600°F**

**A & AR Series
 Round End Caps**

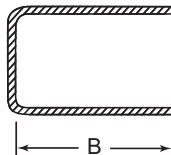
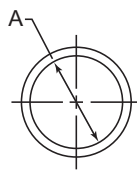

Specifications:

- Material: Low-Density Polyethylene
- Color: See Table

Features:

- Designed to protect outside diameters
- Parts with a W/R have an internal molded ring for extra gripping power
- Parts with AR prefix have internal ribs for superior retention

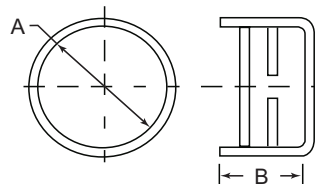

AR Prefix

See pages 64 and 65 for Application Wizards

Item No.	A		B		Color	Bulk Pack Qty
	in	mm	in	mm		
A3/32W/RA	0.094	2.38	0.625	15.88	Blue	5000
A1/8W/RA	0.125	3.18	0.625	15.88	Blue	5000
A5/32W/RA	0.156	3.97	0.625	15.88	Blue	5000
A3/16W/RA	0.187	4.76	0.625	15.88	Blue	5000
A1/4W/RA	0.250	6.35	0.875	22.23	Blue	5000
L1/4A	0.250	6.35	1.750	44.45	Blue	7500
AS9/32A	0.281	7.14	0.500	12.70	Blue	6500
A9/32A	0.281	7.14	0.875	22.23	Blue	6500
AC5/16W/RA	0.295	7.49	0.875	22.23	Blue	6000
A5/16W/RA	0.313	7.94	0.875	22.23	Blue	5000
L5/16A	0.313	7.94	1.750	44.45	Blue	4500
A3/8W/RA	0.375	9.53	0.875	22.23	Blue	4250
L3/8A	0.375	9.53	1.750	44.45	Blue	3800
AR100A	0.390	9.91	0.630	16.00	Red	10000
AS7/16A	0.437	11.11	0.500	12.70	Blue	6000
A7/16W/RA	0.437	11.11	0.875	22.23	Blue	7000
AR105A	0.450	11.43	0.630	16.00	Red	10000
A1/2BA	0.470	11.94	0.875	22.23	Blue	5000
A1/2A	0.495	12.57	0.875	22.23	Blue	5000
AS1/2A	0.500	12.70	0.500	12.70	Blue	5000
A1/2W/RA	0.500	12.70	0.875	22.23	Blue	5000
AS9/16A	0.563	14.29	0.563	14.29	Blue	6500
A9/16A	0.563	14.29	0.875	22.23	Blue	4000
A9/16W/RA	0.563	14.29	0.875	22.23	Blue	4000
AR110A	0.580	14.73	0.787	20.00	Red	5000
AS5/8A	0.625	15.88	0.375	9.53	Blue	4250
A5/8W/RA	0.625	15.88	0.875	22.23	Blue	3500
AR115A	0.630	16.00	0.787	20.00	Red	5000
AS11/16W/RA	0.687	17.46	0.750	19.05	Blue	4000
A11/16A	0.687	17.46	0.875	22.23	Blue	3000
A11/16W/RA	0.687	17.46	0.875	22.23	Blue	3000
A23/32A	0.720	18.29	1.310	33.27	Blue	1700
K505A	0.720	18.29	1.500	38.10	Blue	2800
K505W/RA	0.720	18.29	1.500	38.10	Natural	2800
AR120A	0.727	18.47	0.787	20.00	Red	2500
AS3/4A	0.750	19.05	0.375	9.53	Blue	6000
A3/4A	0.750	19.05	0.875	22.23	Blue	5000
A3/4W/RA	0.750	19.05	0.875	22.23	Blue	5000
AR125A	0.787	20.00	0.787	20.00	Red	2000
AS13/16W/RA	0.813	20.64	0.344	8.73	Blue	6000
A13/16A	0.813	20.64	0.875	22.23	Blue	4500
A13/16W/RA	0.813	20.64	0.875	22.23	Blue	4500
AR130A	0.866	22.00	0.787	20.00	Red	2500
AS7/8W/RA	0.875	22.23	0.500	12.70	Blue	3500
A7/8W/RA	0.875	22.23	0.875	22.23	Blue	4000
L7/8A	0.875	22.23	1.750	44.45	Blue	2000

Item No.	A		B		Color	Bulk Pack Qty
	in	mm	in	mm		
A15/16A	0.937	23.81	0.813	20.64	Blue	3500
AR135A	0.961	24.41	0.827	21.01	Red	2000
A63/64A	0.980	24.89	1.310	33.27	Blue	2000
AS1A	1.000	25.40	0.375	9.53	Blue	4000
A1A	1.000	25.40	0.750	19.05	Blue	3500
A1W/RA	1.000	25.40	0.750	19.05	Blue	3500
AL1A	1.000	25.40	1.000	25.40	Blue	2500
L1B	1.000	25.40	1.750	45.72	Blue	1400
A1-1/16A	1.063	26.99	0.875	22.23	Blue	3000
A1-1/16W/RA	1.063	26.99	0.875	22.23	Blue	3000
AR140A	1.102	28.00	1.043	26.50	Red	1000
A1-1/8A	1.125	28.58	0.875	22.23	Blue	2500
A1-3/16W/RA	1.187	30.16	1.000	25.40	Blue	2000
AR145A	1.200	30.48	1.043	26.50	Red	800
AS1-1/4A	1.250	31.75	0.625	15.88	Blue	3000
A1-1/4A	1.250	31.75	0.875	22.23	Blue	2000
A1-5/16A	1.313	33.34	0.875	22.23	Blue	2000
A1-5/16W/RA	1.313	33.34	0.875	22.23	Blue	2000
A1-3/8A	1.375	34.93	0.875	22.23	Blue	1800
AR150A	1.378	35.00	1.043	26.50	Red	800
A1-7/16A	1.437	36.51	0.875	22.23	Blue	1600
AR155A	1.444	36.68	1.031	26.19	Red	500
A1-1/2A	1.500	38.10	0.875	22.23	Blue	1500
A1-9/16A	1.563	39.69	1.000	25.40	Blue	1200
A1-5/8A	1.625	41.28	1.000	25.40	Blue	1900
A1-11/16A	1.688	42.87	0.875	22.23	Blue	1200
A1-3/4A	1.750	44.45	0.875	22.23	Blue	1200
A1-7/8A	1.875	47.63	0.875	22.23	Blue	1000
A2A	2.000	50.80	0.875	22.23	Blue	1000
A2-1/8A	2.125	53.98	0.875	22.23	Blue	900
AR160A	2.125	54.00	1.094	27.80	Red	300
A2-1/4A	2.250	57.15	1.250	31.75	Blue	450
A2-3/8A	2.375	60.33	0.875	22.23	Blue	700
A2-1/2A	2.500	63.50	0.875	22.23	Blue	600
AS2-9/16A	2.563	65.09	0.375	9.53	Blue	1200
A2-19/32W/RA	2.575	65.40	1.000	25.40	Blue	500
A2-5/8A	2.615	66.42	1.000	25.40	Blue	425
A2-3/4A	2.725	69.22	1.090	27.68	Blue	450
A3A	2.980	75.69	1.000	25.40	Blue	400
A3-1/8A	3.125	79.38	1.375	34.93	Blue	250
A3-1/4A	3.250	82.55	1.875	47.63	Blue	150
A3-1/2A	3.500	88.90	1.000	25.40	Blue	300
A3-3/4A	3.740	94.99	1.000	25.40	Blue	225
A4A	3.990	101.34	1.000	25.40	Blue	200
A4-1/8A	4.115	104.52	1.000	25.40	Blue	200
AR165A	4.331	110.00	1.362	34.60	Yellow	150

PIPE CAPS & PLUGS

See Pages 92 - 95 | www.essentracomponents.com



DM & DMS Series Round Vinyl End Caps

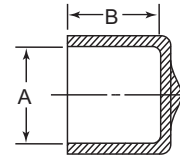
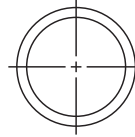

Specifications:

- Material: Vinyl (PVC)
- Color: DM – Black – 75 Durometer
DMS – Red – 63 Durometer
- Temperature Range: Up to 350°F (177°C)
- For high temperature up to 425°F (218°C) see page 71

Features:

- Flexible material can stretch onto larger dimensions for a snug fit without tearing, splitting or shredding
- Typically used to protect threaded or non-threaded tubing, rods, pipe or paper tubes
- Glossy and attractive finish makes this part ideal for use as a decorative end cap
- Red colored parts are highly visible

See pages 64 and 65 for Application Wizards

A = To Fit		Item No.			Bulk Pack Qty			
in	mm	B Length			Color	1/2 in	1 in	1 - 1/2 in
		1/2 in (12.70 mm)	1 in (25.40 mm)	1 - 1/2 in (38.10 mm)				
0.078	1.98	DM0080-1/2A	DM0080-1A	—	Black	5000	5000	—
0.094	2.38	DM0093-1/2A	DM0093-1A	—	Black	5000	10000	—
0.109	2.78	DM0110-1/2A	DM0110-1A	—	Black	5000	5000	—
0.125	3.18	DM0125-1/2A	DM0125-1A	—	Black	5000	5000	—
0.125	3.18	—	DMS0125-1A	—	Red	—	5000	—
0.141	3.57	DM0140-1/2A	DM0140-1A	DM0140-1-1/2A	Black	5000	5000	5000
0.141	3.57	—	DMS0140-1A	—	Red	—	5000	—
0.148	3.76	DM0148-1/2A	DM0148-1A	DM0148-1-1/2A	Black	5000	5000	5000
0.156	3.97	DM0156-1/2A	DM0156-1A	DM0156-1-1/2A	Black	5000	5000	5000
0.172	4.37	DM0172-1/2A	DM0172-1A	DM0172-1-1/2A	Black	5000	5000	5000
0.172	4.37	—	DMS0172-1A	—	Red	—	5000	—
0.180	4.57	DM0180-1/2A	DM0180-1A	DM0180-1-1/2A	Black	5000	5000	5000
0.187	4.75	DM0187-1/2A	DM0187-1A	DM0187-1-1/2A	Black	5000	5000	5000
0.187	4.75	—	DMS0187-1A	—	Red	—	5000	—
0.203	5.16	DM0203-1/2A	DM0203-1A	DM0203-1-1/2A	Black	5000	5000	5000
0.203	5.16	—	DMS0203-1A	—	Red	—	5000	—
0.207	5.26	DM0207-1/2A	DM0207-1A	DM0207-1-1/2A	Black	5000	5000	5000
0.218	5.54	DM0218-1/2A	DM0218-1A	DM0218-1-1/2A	Black	5000	5000	5000
0.224	5.69	DM0224-1/2A	DM0224-1A	DM0224-1-1/2A	Black	5000	5000	5000
0.230	5.84	DM0230-1/2A	DM0230-1A	DM0230-1-1/2A	Black	5000	7500	5000
0.234	5.95	DM0234-1/2A	DM0234-1A	DM0234-1-1/2A	Black	5000	5000	3000
0.234	5.95	—	DMS0234-1A	—	Red	—	5000	—
0.240	6.10	DM0240-1/2A	DM0240-1A	DM0240-1-1/2A	Black	5000	5000	5000
0.250	6.35	DM0250-1/2A	DM0250-1A	DM0250-1-1/2A	Black	5000	5000	5000
0.250	6.35	DMS0250-1/2A	DMS0250-1A	—	Red	5000	5000	—
0.281	7.14	DM0281-1/2A	DM0281-1A	DM0281-1-1/2A	Black	5000	5000	5000
0.281	7.14	DMS0281-1/2A	DMS0281-1A	—	Red	5000	5000	—
0.290	7.37	DM0290-1/2A	DM0290-1A	DM0290-1-1/2A	Black	5000	5000	5000
0.304	7.72	DM0304-1/2A	DM0304-1A	DM0304-1-1/2A	Black	5000	5000	2500
0.313	7.94	DM0313-1/2A	DM0313-1A	DM0313-1-1/2A	Black	5000	5000	4000
0.313	7.94	DMS0313-1/2A	DMS0313-1A	—	Red	5000	5000	—
0.343	8.71	DM0343-1/2A	DM0343-1A	DM0343-1-1/2A	Black	5000	5000	4000
0.343	8.71	—	DMS0343-1A	—	Red	—	5000	—
0.360	9.14	DM0360-1/2A	DM0360-1A	DM0360-1-1/2A	Black	5000	5000	2500
0.375	9.53	DM0375-1/2A	DM0375-1A	DM0375-1-1/2A	Black	5000	5000	2500
0.375	9.53	DMS0375-1/2A	DMS0375-1A	—	Red	5000	5000	—
0.406	10.32	DM0406-1/2A	DM0406-1A	DM0406-1-1/2A	Black	5000	5000	5000
0.420	10.66	DM0420-1/2A	DM0420-1A	DM0420-1-1/2A	Black	5000	5000	5000
0.437	11.10	DM0437-1/2A	DM0437-1A	DM0437-1-1/2A	Black	5000	5000	4000
0.437	11.10	DMS0437-1/2A	DMS0437-1A	DMS0437-1-1/2A	Red	5000	5000	4000
0.460	11.68	DM0460-1/2A	DM0460-1A	DM0460-1-1/2A	Black	5000	3000	1500
0.470	11.94	DM0470-1/2A	DM0470-1A	DM0470-1-1/2A	Black	5000	5000	3000
0.470	11.94	—	DMS0470-1A	—	Red	—	5000	—
0.490	12.45	DM0490-1/2A	DM0490-1A	DM0490-1-1/2A	Black	5000	3000	1500
0.500	12.70	DM0500-1/2A	DM0500-1A	DM0500-1-1/2A	Black	5000	5000	2500
0.500	12.70	DMS0500-1/2A	DMS0500-1A	DMS0500-1-1/2A	Red	5000	5000	2500
0.523	13.28	DM0523-1/2A	DM0523-1A	DM0523-1-1/2A	Black	5000	2500	2500
0.531	13.49	DM0531-1/2A	DM0531-1A	DM0531-1-1/2A	Black	5000	5000	2500
0.531	13.49	—	DMS0531-1A	—	Red	—	5000	—
0.544	13.82	DM0544-1/2A	DM0544-1A	DM0544-1-1/2A	Black	5000	5000	2500
0.544	13.82	—	DMS0544-1A	—	Red	—	5000	—
0.562	14.27	DM0562-1/2A	DM0562-1A	DM0562-1-1/2A	Black	5000	2500	3000
0.562	14.27	DMS0562-1/2A	DMS0562-1A	DMS0562-1-1/2A	Red	5000	2500	3000
0.587	14.90	DM0587-1/2A	DM0587-1A	DM0587-1-1/2A	Black	5000	2500	1200
0.600	15.24	DM0600-1/2A	DM0600-1A	DM0600-1-1/2A	Black	5000	2000	1200
0.625	15.88	DM0625-1/2A	DM0625-1A	DM0625-1-1/2A	Black	5000	2500	1250
0.625	15.88	DMS0625-1/2A	DMS0625-1A	DMS0625-1-1/2A	Red	5000	2500	1250
0.640	16.26	DM0640-1/2A	DM0640-1A	DM0640-1-1/2A	Black	5000	5000	2500
0.665	16.89	DM0665-1/2A	DM0665-1A	DM0665-1-1/2A	Black	5000	2500	2500
0.687	17.45	DM0687-1/2A	DM0687-1A	DM0687-1-1/2A	Black	5000	2500	1500
0.687	17.45	DMS0687-1/2A	DMS0687-1A	DMS0687-1-1/2A	Red	5000	2500	1500
0.725	18.42	DM0725-1/2A	DM0725-1A	DM0725-1-1/2A	Black	5000	2500	1000
0.750	19.05	DM0750-1/2A	DM0750-1A	DM0750-1-1/2A	Black	5000	2500	500
0.750	19.05	DMS0750-1/2A	DMS0750-1A	DMS0750-1-1/2A	Red	5000	2500	500
0.812	20.62	DM0812-1/2A	DM0812-1A	DM0812-1-1/2A	Black	2500	2500	1000
0.812	20.62	DMS0812-1/2A	DMS0812-1A	DMS0812-1-1/2A	Red	2500	2500	1000
0.843	21.41	DM0843-1/2A	DM0843-1A	DM0843-1-1/2A	Black	5000	2500	1200
0.843	21.41	—	DMS0843-1A	—	Red	—	2500	—

(Continued on next page >)



PUSH-FIT CAPS

**DM & DMS Series
Round Vinyl End Caps (continued)**

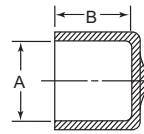
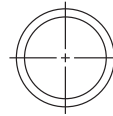

See pages 64 and 65 for Application Wizards

A = To Fit		Item No.			Color	Bulk Pack Qty		
in	mm	1/2 in (12.70 mm)	1 in (25.40 mm)	1 - 1/2 in (38.10 mm)		1/2 in	1 in	1 - 1/2 in
0.875	22.23	DM0875-1/2A	DM0875-1A	DM0875-1-1/2A	Black	5000	2500	1250
0.875	22.23	DMS0875-1/2A	DMS0875-1A	DMS0875-1-1/2A	Red	5000	2500	1250
0.937	23.80	DM0937-1/2A	DM0937-1A	DM0937-1-1/2A	Black	2500	2500	1000
0.937	23.80	—	DMS0937-1A	—	Red	—	2500	—
0.985	25.02	DM0985-1/2A	DM0985-1A	DM0985-1-1/2A	Black	2500	1500	1250
1.000	25.40	DM1000-1/2A	DM1000-1A	DM1000-1-1/2A	Black	2500	2000	1250
1.000	25.40	DMS1000-1/2A	DMS1000-1A	DMS1000-1-1/2A	Red	2500	2000	1250
1.062	26.97	DM1062-1/2A	DM1062-1A	DM1062-1-1/2A	Black	3000	1500	1250
1.062	26.97	—	DMS1062-1A	—	Red	—	1500	—
1.090	27.69	DM1090-1/2A	DM1090-1A	DM1090-1-1/2A	Black	2000	1000	500
1.125	28.58	DM1125-1/2A	DM1125-1A	DM1125-1-1/2A	Black	1000	1000	500
1.125	28.58	DMS1125-1/2A	DMS1125-1A	DMS1125-1-1/2A	Red	1000	1000	500
1.187	30.15	DM1187-1/2A	DM1187-1A	DM1187-1-1/2A	Black	2500	1000	1000
1.187	30.15	—	DMS1187-1A	—	Red	—	1000	—
1.250	31.75	DM1250-1/2A	DM1250-1A	DM1250-1-1/2A	Black	2500	1000	700
1.250	31.75	DMS1250-1/2A	DMS1250-1A	DMS1250-1-1/2A	Red	2500	1000	700
1.312	33.32	DM1312-1/2A	DM1312-1A	DM1312-1-1/2A	Black	2000	1000	500
1.375	34.93	DM1375-1/2A	DM1375-1A	DM1375-1-1/2A	Black	2000	1000	650
1.375	34.93	—	DMS1375-1A	—	Red	—	1000	—
1.437	36.50	DM1437-1/2A	DM1437-1A	DM1437-1-1/2A	Black	1000	1000	600
1.500	38.10	DM1500-1/2A	DM1500-1A	DM1500-1-1/2A	Black	1000	1000	600
1.500	38.10	DMS1500-1/2A	DMS1500-1A	DMS1500-1-1/2A	Red	1000	1000	600
1.593	40.46	DM1593-1/2A	DM1593-1A	DM1593-1-1/2A	Black	1700	1000	500
1.625	41.28	DM1625-1/2A	DM1625-1A	DM1625-1-1/2A	Black	500	750	500
1.625	41.28	—	DMS1625-1A	DMS1625-1-1/2A	Red	—	750	500
1.687	42.85	DM1687-1/2A	DM1687-1A	DM1687-1-1/2A	Black	1000	500	400
1.687	42.85	—	DMS1687-1A	—	Red	—	500	—
1.750	44.45	DM1750-1/2A	DM1750-1A	DM1750-1-1/2A	Black	1000	500	500
1.750	44.45	—	DMS1750-1A	DMS1750-1-1/2A	Red	—	500	500
1.812	46.02	DM1812-1/2A	DM1812-1A	DM1812-1-1/2A	Black	1000	500	400
1.875	47.63	DM1875-1/2A	DM1875-1A	DM1875-1-1/2A	Black	700	625	400
1.875	47.63	—	DMS1875-1A	—	Red	—	625	—
1.937	49.19	DM1937-1/2A	DM1937-1A	DM1937-1-1/2A	Black	1000	550	400
2.000	50.80	DM2000-1/2A	DM2000-1A	DM2000-1-1/2A	Black	1000	550	400
2.000	50.80	DMS2000-1/2A	DMS2000-1A	DMS2000-1-1/2A	Red	1000	550	400
2.125	53.98	DM2125-1/2A	DM2125-1A	DM2125-1-1/2A	Black	500	400	300
2.125	53.98	—	DMS2125-1A	—	Red	—	400	—
2.156	54.76	DM2156-1/2A	DM2156-1A	DM2156-1-1/2A	Black	1000	550	250
2.250	57.15	DM2250-1/2A	DM2250-1A	DM2250-1-1/2A	Black	250	500	300
2.250	57.15	—	DMS2250-1A	DMS2250-1-1/2A	Red	—	500	300
2.375	60.33	DM2375-1/2A	DM2375-1A	DM2375-1-1/2A	Black	500	350	250
2.460	62.48	DM2460-1/2A	DM2460-1A	DM2460-1-1/2A	Black	1000	350	200
2.500	63.50	DM2500-1/2A	DM2500-1A	DM2500-1-1/2A	Black	500	300	200
2.500	63.50	—	DMS2500-1A	DMS2500-1-1/2A	Red	—	300	200
2.625	66.68	DM2625-1/2A	DM2625-1A	DM2625-1-1/2A	Black	500	250	250
2.687	68.25	DM2687-1/2A	DM2687-1A	DM2687-1-1/2A	Black	400	250	200
2.750	69.85	DM2750-1/2A	DM2750-1A	DM2750-1-1/2A	Black	500	250	250
2.750	69.85	—	DMS2750-1A	—	Red	—	250	—
2.875	73.03	DM2875-1/2A	DM2875-1A	DM2875-1-1/2A	Black	500	250	200
3.000	76.20	DM3000-1/2A	DM3000-1A	DM3000-1-1/2A	Black	500	300	200
3.000	76.20	—	DMS3000-1A	DMS3000-1-1/2A	Red	—	300	200
3.125	79.38	—	DM3125-1A	DM3125-1-1/2A	Black	—	250	150
3.125	79.38	—	DMS3125-1A	—	Red	—	250	150
3.250	82.55	—	DM3250-1A	DM3250-1-1/2A	Black	—	100	100
3.250	82.55	—	DMS3250-1A	—	Red	—	100	—
3.375	85.73	—	DM3375-1A	DM3375-1-1/2A	Black	—	200	150
3.500	88.90	DM3500-1/2A	DM3500-1A	DM3500-1-1/2A	Black	—	175	100
3.500	88.90	—	DMS3500-1A	—	Red	—	175	—
3.625	92.08	—	DM3625-1A	DM3625-1-1/2A	Black	—	150	100
3.750	95.25	—	DM3750-1A	DM3750-1-1/2A	Black	—	100	100
3.750	95.25	—	DMS3750-1A	—	Red	—	100	—
3.825	97.16	—	DM3825-1A	DM3825-1-1/2A	Black	—	150	100
3.875	98.43	—	DM3875-1A	DM3875-1-1/2A	Black	—	100	100
4.000	101.60	DM4000-1/2A	DM4000-1A	DM4000-1-1/2A	Black	—	150	100
4.000	101.60	—	DMS4000-1A	DMS4000-1-1/2A	Red	—	150	100
4.125	104.78	—	DM4125-1A	DM4125-1-1/2A	Black	—	100	100
4.187	106.35	—	DM4187-1A	DM4187-1-1/2A	Black	—	100	100
4.250	107.95	—	DM4250-1A	DM4250-1-1/2A	Black	—	150	100
4.375	111.13	—	DM4375-1A	DM4375-1-1/2A	Black	—	100	50
4.500	114.30	DM4500-1/2A	DM4500-1A	DM4500-1-1/2A	Black	—	150	75
4.750	120.65	—	DM4750-1A	DM4750-1-1/2A	Black	—	85	100
5.000	127.00	—	DM5000-1A	DM5000-1-1/2A	Black	—	125	50
5.187	131.75	—	DM5187-1A	DM5187-1-1/2A	Black	—	50	50
5.375	136.53	—	DM5375-1A	DM5375-1-1/2A	Black	—	100	50
5.500	139.70	DM5500-1/2A	DM5500-1A	DM5500-1-1/2A	Black	—	50	50
5.750	146.05	—	DM5750-1A	DM5750-1-1/2A	Black	—	50	50
6.000	152.40	—	DM6000-1A	DM6000-1-1/2A	Black	—	50	50
6.250	158.75	—	DM6250-1A	DM6250-1-1/2A	Black	—	50	50
6.500	165.10	DM6500-1/2A	DM6500-1A	DM6500-1-1/2A	Black	—	50	50
6.750	171.45	—	DM6750-1A	DM6750-1-1/2A	Black	—	25	50
7.000	177.80	—	DM7000-1A	DM7000-1-1/2A	Black	—	25	25
7.250	184.15	—	DM7250-1A	DM7250-1-1/2A	Black	—	50	50
7.500	190.50	—	DM7500-1A	DM7500-1-1/2A	Black	—	50	25
7.750	196.85	—	DM7750-1A	DM7750-1-1/2A	Black	—	50	50
8.000	203.20	—	DM8000-1A	DM8000-1-1/2A	Black	—	50	25



DMPC Series Easy-Pull Vinyl Caps



Specifications:

- Material: Vinyl (PVC)
- Color: Black
- Temperature Range: Up to 350°F (177°C)
- For high temperature up to 425°F (218°C) see page 71

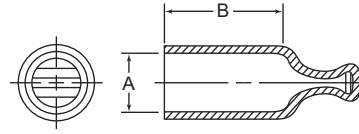

Features:

- The curved pull-tab design provides more surface contact area requiring less gripping force during installation and removal
- Flexible material can stretch onto larger dimensions for a snug fit without tearing, splitting or shredding
- Glossy and attractive finish makes this part ideal for use as a decorative end cap

A = To Fit		Item No.			Bulk Pack Qty		
In	mm	1/2 in (12.70 mm)	1 in (25.40 mm)	1 - 1/2 in (38.10 mm)	1/2 in	1 in	1 - 1/2 in
0.187	4.75	DMPC0180-1/2A	DMPC0180-1A	—	5000	5000	—
0.218	5.54	DMPC0207-1/2A	DMPC0207-1A	—	5000	5000	—
0.250	6.35	DMPC0240-1/2A	DMPC0240-1A	—	5000	5000	—
0.302	7.67	DMPC0302-1/2A	DMPC0302-1A	DMPC0302-1-1/2A	7500	5000	2500
0.320	8.13	DMPC0320-1/2A	DMPC0320-1A	DMPC0320-1-1/2A	5000	5000	2500
0.343	8.71	DMPC0343-1/2A	DMPC0343-1A	DMPC0343-1-1/2A	5000	3000	2500
0.375	9.53	DMPC0365-1/2A	DMPC0365-1A	DMPC0365-1-1/2A	5000	3000	2000
0.406	10.32	DMPC0396-1/2A	DMPC0396-1A	DMPC0396-1-1/2A	5000	5000	2500
0.420	10.67	DMPC0420-1/2A	DMPC0420-1A	DMPC0420-1-1/2A	5000	5000	2500
0.437	11.10	DMPC0427-1/2A	DMPC0427-1A	DMPC0427-1-1/2A	5000	4000	2500
0.450	11.43	DMPC0450-1/2A	DMPC0450-1A	DMPC0450-1-1/2A	5000	4000	2500
0.472	11.99	DMPC0470-1/2A	DMPC0470-1A	DMPC0470-1-1/2A	5000	4000	2500
0.500	12.70	DMPC0490-1/2A	DMPC0490-1A	DMPC0490-1-1/2A	5000	4000	2000
0.531	13.49	DMPC0521-1/2A	DMPC0521-1A	DMPC0521-1-1/2A	5000	4000	2500
0.562	14.27	DMPC0552-1/2A	DMPC0552-1A	DMPC0552-1-1/2A	2500	2500	2500
0.593	15.06	DMPC0590-1/2A	DMPC0590-1A	DMPC0590-1-1/2A	2500	1900	1500
0.600	15.24	DMPC0600-1/2A	DMPC0600-1A	DMPC0600-1-1/2A	5000	2500	2500
0.615	15.62	DMPC0615-1/2A	DMPC0615-1A	DMPC0615-1-1/2A	5000	2500	2000
0.625	15.88	DMPC0625-1/2A	DMPC0625-1A	DMPC0625-1-1/2A	2500	1350	1500
0.655	16.64	DMPC0655-1/2A	DMPC0655-1A	DMPC0655-1-1/2A	2000	2500	1500
0.677	17.20	DMPC0677-1/2A	DMPC0677-1A	DMPC0677-1-1/2A	5000	2500	1500
0.687	17.45	DMPC0687-1/2A	DMPC0687-1A	DMPC0687-1-1/2A	2500	2000	1500
0.708	17.98	DMPC0708-1/2A	DMPC0708-1A	DMPC0708-1-1/2A	2500	2000	1500
0.750	19.05	DMPC0740-1/2A	DMPC0740-1A	DMPC0740-1-1/2A	4000	2500	1500
0.812	20.62	DMPC0812-1/2A	DMPC0812-1A	DMPC0812-1-1/2A	2500	2000	750
0.875	22.23	DMPC0865-1/2A	DMPC0865-1A	DMPC0865-1-1/2A	1500	1500	750
0.937	23.79	DMPC0937-1/2A	DMPC0937-1A	DMPC0937-1-1/2A	1500	1500	750
1.000	25.40	DMPC0990-1/2A	DMPC0990-1A	DMPC0990-1-1/2A	1500	1500	750
1.060	26.92	—	DMPC1060-1A	DMPC1060-1-1/2A	—	1000	700
1.125	28.58	—	DMPC1125-1A	DMPC1125-1-1/2A	—	1000	700
1.250	31.75	—	DMPC1230-1A	DMPC1230-1-1/2A	—	1000	700
1.500	38.10	—	DMPC1500-1A	DMPC1500-1-1/2A	—	700	250
1.625	41.28	—	DMPC1605-1A	DMPC1605-1-1/2A	—	550	350

FEC Series Flexible End Caps



Type 1

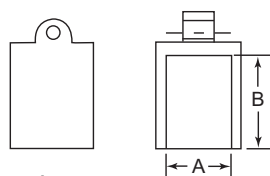

Type 2

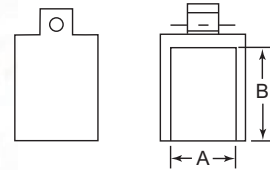

Specifications:

- Material: Thermoplastic Elastomer
- Temperature Range: 203°F (95°C)
- Color: Black

Features:

- Flexible material can stretch onto larger diameters for a snug fit
- Good resistance to acids
- Can be used with Masking Hooks on page 85



Item No.	Type	A		B		Bulk Pack Qty
		In	mm	In	mm	
1340242	2	0.157	4.0	0.945	24.0	10000
12200B	1	0.197	5.0	0.925	23.5	10000
1341946	2	0.236	6.0	0.984	25.0	10000
1287248	2	0.276	7.0	0.945	24.0	10000
1287251	2	0.315	8.0	0.965	24.5	8000
12204B	1	0.354	9.0	0.984	25.0	7000
1341978	2	0.394	10.0	1.161	29.5	5000
1341987	2	0.433	11.0	1.142	29.0	4500
12207B	1	0.472	12.0	1.142	29.0	4000
1341981	2	0.512	13.0	1.142	29.0	3500
12209B	1	0.551	14.0	1.161	29.5	3000
12210B	1	0.591	15.0	1.161	29.5	2500
12211B	1	0.630	16.0	1.102	28.0	2500
12212B	1	0.669	17.0	1.161	29.5	2000

Item No.	Type	A		B		Bulk Pack Qty
		In	mm	In	mm	
12213B	2	0.709	18.0	1.122	28.5	2000
1287245	2	0.748	19.0	1.161	29.5	2000
1341984	2	0.787	20.0	1.122	28.5	1600
12216B	1	0.827	21.0	1.358	34.5	1300
12217B	2	0.866	22.0	1.339	34.0	1200
12218B	2	0.906	23.0	1.358	34.5	1000
1341988	2	0.945	24.0	1.339	34.0	1000
12220B	2	0.984	25.0	1.358	34.5	1000
12221B	2	1.024	26.0	1.358	34.5	900
12222B	2	1.063	27.0	1.319	33.5	900
1287254	2	1.102	28.0	1.319	33.5	800
12224B	2	1.142	29.0	1.378	35.0	800
1287243	2	1.181	30.0	1.358	34.5	600



PUSH-FIT CAPS

MCP Series Stretch Fit Cover Caps

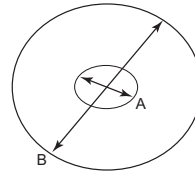

Specifications:

- Material: Polyethylene
- Color: See Table

Features:

- Capable of covering a wide range of part diameters and shapes
- Protects against dirt and moisture during storage and shipping
- Reusable

Item No.		A= Elastic Ø		B= Flat Overall Ø		Bulk Pack Qty
Blue	Clear	in	mm	in	mm	
MCP050B	MCP050N	1.00	25.40	3.00	76.20	1000
MCP100B	MCP100N	1.22	30.99	3.78	96.01	1000
MCP105B	MCP105N	1.25	50.80	8.00	203.20	500
MCP110B	MCP110N	1.50	38.10	4.50	114.30	1000
MCP120B	MCP120N	2.00	50.80	5.75	146.05	1000
MCP125B	MCP125N	2.50	63.50	10.00	254.00	500
MCP130B	MCP130N	2.44	61.98	8.66	219.96	500
MCP140B	MCP140N	3.07	77.98	9.45	240.03	500
MCP145B	MCP145N	3.50	88.90	18.00	457.20	300
MCP150B	MCP150N	4.25	107.95	13.00	330.20	250
MCP155B	MCP155N	5.75	146.05	24.00	609.60	200
MCP160B	MCP160N	5.00	127.00	15.95	405.13	250
MCP165B	MCP165N	6.50	165.10	32.00	812.80	100

MFC Series Finned Stud Caps

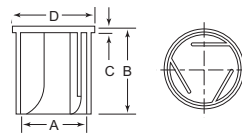

Type 1



Specifications:

- Material: Low-Density Polyethylene
- Color: Natural

Features:

- Unique finned design enables each cap to fit a range of stud diameters
- The MFC010A* has beveled corners

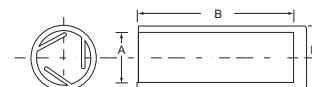

Type 2



Item No.	Stud Size Range		Type	A		B		C		D		Bulk Pack Qty
	in	mm		in	mm	in	mm	in	mm	in	mm	
MFC110A	0.255 - 0.314	6.5 - 8.0	1	0.394	10	0.866	22	0.059	1.5	0.551	14.0	500
MFC010A*	0.255 - 0.314	6.5 - 8.0	2	0.394	10	1.299	33	—	—	0.433	11.0	5000
MFC120A	0.314 - 0.354	8.0 - 9.0	1	0.433	11	0.866	22	0.059	1.5	0.591	15.0	500
MFC020A	0.314 - 0.354	8.0 - 9.0	2	0.433	11	0.866	22	—	—	0.472	12.0	5000
MFC030A	0.354 - 0.393	9.0 - 10	2	0.472	12	0.866	22	—	—	0.511	13.0	5000
MFC130A	0.354 - 0.413	9.0 - 10.5	1	0.492	12.5	0.866	22	0.059	1.5	0.650	16.5	250
MFC140A	0.433 - 0.512	11.0 - 13.0	1	0.630	16	0.866	22	0.059	1.5	0.787	20.0	250
MFC150A	0.551 - 0.629	14.0 - 16.0	1	0.709	18	0.866	22	0.059	1.5	0.866	22.0	250
MFC160A	0.669 - 0.748	17.0 - 19.0	1	0.866	22	0.866	22	0.059	1.5	1.024	26.0	100
MFC170A	0.787 - 0.866	20.0 - 22.0	1	0.984	25	0.984	25	0.059	1.5	1.142	29.0	100
MFC180A	0.944 - 1.023	24.0 - 26.0	1	1.142	29	1.181	30	0.059	1.5	1.299	33.0	100
MFC190A	1.102 - 1.181	28.0 - 30.0	1	1.299	33	1.339	34	0.059	1.5	1.457	37.0	100

MC Series Meter Caps

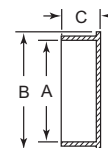
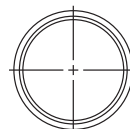

Specifications:

- Material: Low-Density Polyethylene
- Color: Black

Features:

- Designed to protect threads on gas and water meters
- Remains on the unit until installation

Item No.	Thread Size	A		B		C		Bulk Pack Qty
		in	mm	in	mm	in	mm	
• MC5LT	5LT	1.114	28.3	1.380	35.1	0.640	16.3	2500
MC10LT	10LT	1.415	35.9	1.670	42.4	0.640	16.3	1500
MC1S	#1 Sprague	1.600	40.6	1.820	46.2	0.610	15.5	1200
• MC1P	#1 Pittsburgh	1.610	40.9	1.870	47.5	0.640	16.3	1200
MC20LT	20LT	1.808	45.9	2.070	52.6	0.640	16.3	1000
MC2S	#2 Sprague	1.850	47.0	2.110	53.6	0.640	16.3	1000
MC30LT	30 LT	2.028	51.5	2.290	58.2	0.670	17.0	750
MC45LT	45LT	2.252	57.2	2.510	63.8	0.870	22.1	500
MC3S	#3 Sprague	2.316	58.8	2.580	65.5	0.940	23.9	500



E Series Flanged Caps for Standard Threads

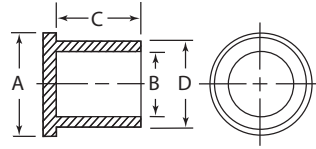

Specifications:

- Material: Low-Density Polyethylene
- Color: See Table

Features:

- Designed for easy assembly and removal either with automated equipment or by hand
- Typically used to protect standard threads with or without O-Rings



Item No.		To Cap Standard Thread	A		B		C		D		Bulk Pack Qty
Natural	Orange		in	mm	in	mm	in	mm	in	mm	
E5/16C	E5/16A	5/16	0.510	12.95	0.315	8.00	0.840	21.33	0.377	9.57	5000
—	E3/8A	3/8	0.531	13.49	0.364	9.25	0.590	16.67	0.428	10.87	5000
E3/8AA	—	3/8	0.580	14.73	0.377	9.58	0.840	21.34	0.447	11.35	5000
EL3/8B	EL3/8A	3/8	0.520	13.21	0.370	9.40	1.280	32.51	0.440	11.18	5000
E7/16A	—	7/16	0.625	15.88	0.428	10.87	0.590	14.99	0.492	12.50	4250
E7/16CATB	—	7/16	0.625	15.88	0.429	10.90	0.600	15.24	0.491	12.47	4250
EL7/16B	EL7/16A	7/16	0.580	14.73	0.428	10.87	1.020	25.91	0.495	12.57	5000
—	EL7/16AA	7/16	0.580	14.73	0.425	10.79	1.330	33.98	0.487	12.37	2800
E1/2A	—	1/2	0.720	18.29	0.490	12.45	0.460	11.68	0.550	13.97	4000
EL1/2A	—	1/2	0.640	16.25	0.490	12.45	1.330	33.78	0.552	14.02	2800
EL9/16A	—	9/16	0.700	17.78	0.550	13.97	1.410	35.81	0.620	15.75	2500
E9/16A	—	9/16	0.810	20.57	0.551	14.00	0.490	12.45	0.621	15.77	5900
E5/8B	E5/8A	5/8	0.813	20.64	0.606	15.39	0.750	19.05	0.677	17.20	4000
EL5/8A	—	5/8	0.760	19.30	0.625	15.88	0.840	21.34	0.687	17.48	3000
E11/16B	—	11/16	0.935	23.75	0.675	17.14	0.500	17.15	0.745	12.70	4000
—	EL11/16A	11/16	0.840	21.33	0.678	17.22	0.880	22.35	0.748	18.99	2500
E3/4B	E3/4A	3/4	1.000	25.40	0.720	18.29	0.688	17.46	0.794	20.17	3000
E3/4CATA	—	3/4	1.000	25.40	0.729	18.52	0.625	15.88	0.786	19.96	3000
EL3/4D	EL3/4A	3/4	0.890	22.61	0.740	18.80	1.540	39.12	0.813	20.65	2500
E13/16A	—	13/16	1.060	26.92	0.800	20.32	0.570	14.48	0.870	22.10	2500
—	K324A	13/16	1.060	20.64	0.605	15.37	0.845	21.50	0.665	16.89	3500
E7/8SA	—	7/8	1.120	28.45	0.864	21.95	0.690	17.53	0.926	23.52	4000
—	E7/8A	7/8	1.096	27.84	0.860	21.84	0.875	22.23	0.933	23.70	3500
E7/8CATB	—	7/8	1.096	27.84	0.865	21.97	0.832	21.13	0.921	23.39	3500
EL7/8B	EL7/8A	7/8	1.010	25.65	0.860	21.84	1.700	43.18	0.929	23.60	2000
E1A	—	1	1.246	31.65	0.993	25.22	0.660	16.76	1.056	26.82	1500
—	E1-1/16A	1 - 1/16	1.187	30.15	1.030	26.16	1.062	27.98	1.092	27.74	2000
E1-1/16CATB	—	1 - 1/16	1.288	32.72	1.043	26.49	0.688	17.48	1.114	28.30	2800
E1-3/16B	—	1 - 3/16	1.432	36.37	1.172	29.77	0.760	19.30	1.242	31.55	2000
E1-5/16B	—	1 - 5/16	1.567	39.80	1.302	33.07	0.760	19.30	1.372	34.85	1800
E1-7/16B	—	1 - 7/16	1.697	43.10	1.432	36.37	0.760	19.30	1.502	38.15	1500
E1-5/8B	—	1 - 5/8	1.875	47.63	1.615	41.02	0.835	21.21	1.685	42.80	1100
E1-11/16B	—	1 - 11/16	1.928	48.97	1.668	42.37	0.835	21.21	1.738	44.15	1000
E1-7/8A	E1-7/8B	1 - 7/8	2.131	54.13	1.871	47.52	0.960	24.38	1.941	49.30	900
E2B	E2A	2	2.256	57.30	1.994	50.65	1.085	27.56	2.064	52.43	600
E2-1/2A	—	2 - 1/2	2.756	70.00	2.491	63.27	1.210	30.73	2.566	65.18	350

ECS Series Flanged Caps for NPT Threads

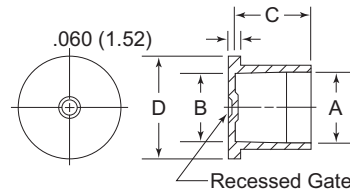

Specifications:

- Material: Low-Density Polyethylene
- Color: Natural

Features:

- Designed for easy assembly and removal either with automated equipment or by hand
- Typically used to protect NPT threads with or without O-Rings



Item No.	To Cap NPT Thread	A		B		C		D		Bulk Pack Qty
		in	mm	in	mm	in	mm	in	mm	
ECS0125A	1/8"	0.399	10.13	0.383	9.73	0.380	9.65	0.660	16.76	10000
ECS0250A	1/4"	0.533	13.54	0.510	12.90	0.530	13.46	0.810	20.57	9000
ECS0375A	3/8"	0.669	16.99	0.644	16.36	0.530	13.46	0.940	23.88	5000
ECS0500A	1/2"	0.833	21.16	0.800	20.32	0.720	18.29	1.090	27.69	3000
ECS0750A	3/4"	1.045	26.54	1.011	25.68	0.750	19.05	1.310	33.27	2000
ECS1000A	1"	1.310	33.27	1.267	32.18	0.930	23.62	1.560	39.62	1000
ECS1250A	1 - 1/4"	1.655	42.04	1.611	40.92	0.970	24.64	1.940	49.28	800
ECS1500A	1 - 1/2"	1.893	48.08	1.848	46.94	0.970	24.64	2.160	54.86	600
ECS2000A	2"	2.370	60.20	2.323	59.00	1.030	26.16	2.620	66.55	500



PUSH-FIT CAPS FOR THREADS

ECM Series Flanged Caps for Metric Threads

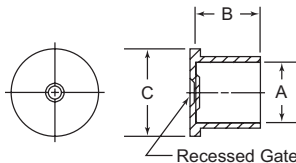

Specifications:

- Material: Low-Density Polyethylene
- Color: Natural

Features:

- Designed for easy assembly and removal either with automated equipment or by hand
- Typically used to protect metric threads with or without O-Rings

Item No.	To Cap Metric Thread	A		B		C		Bulk Pack Qty
		in	mm	in	mm	in	mm	
ECM10A	M10	0.385	9.78	0.665	16.89	0.530	13.50	8000
ECM12A	M12	0.463	11.75	0.470	11.95	0.768	19.50	7000
ECM14A	M14	0.540	13.72	0.470	11.95	0.846	21.50	5000
ECM16A	M16	0.617	15.67	0.470	11.95	0.925	23.50	5000
ECM18A	M18	0.696	17.68	0.470	11.95	1.004	25.50	3000

Item No.	To Cap Metric Thread	A		B		C		Bulk Pack Qty
		in	mm	in	mm	in	mm	
ECM20A	M20	0.774	19.66	0.553	14.05	1.083	27.50	2500
ECM22A	M22	0.855	21.72	0.553	14.05	1.161	29.50	3000
ECM33A	M33	1.285	32.64	0.687	17.45	1.590	40.39	2000
ECM38A	M38	1.481	37.62	0.748	19.00	1.751	44.50	1000
ECM42A	M42	1.640	41.68	0.748	19.00	1.948	49.50	1000

TS Series Tear Tab Caps for SAE/JIC Threads

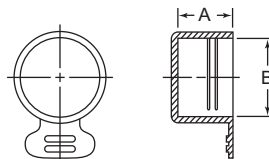

Specifications:

- Material: Low-Density Polyethylene
- Color: See Table

Features:

- Designed with a tear tab for easy removal
- Made to protect standard threads from damage but versatile enough to be used in numerous applications

Item No.		To Cap Standard Thread	SAE/JIC Fitting Size	A		B		Bulk Pack Qty
Natural	Blue			in	mm	in	mm	
TS3B	TS3A	3/8" - 24	3	0.437	11.10	0.364	9.25	6500
TS4B	TS4A	7/16" - 20	4	0.460	11.68	0.433	11.00	5500
TS5B	TS5A	1/2" - 20	5	0.460	11.68	0.490	12.45	4500
TS6B	TS6A	9/16" - 18	6	0.475	12.07	0.551	14.00	7000
TS7B	TS7A	11/16" - 16	7	0.475	12.07	0.675	17.15	5000
TS8B	TS8A	3/4" - 16	8	0.560	14.22	0.740	18.80	3500
TS9B	TS9A	13/16" - 16	9	0.560	14.22	0.802	20.37	3000
TS10B	TS10A	7/8" - 14	10	0.650	16.51	0.873	22.17	4500
TS11B	TS11A	1" - 14	11	0.650	16.51	0.986	25.04	4000
TS12B	TS12A	1-1/16" - 12	12	0.750	19.05	1.053	26.75	3000
TS13B	TS13A	1-3/16" - 12	13	0.750	19.05	1.172	29.77	2700
TS16B	TS16A	1-5/16" - 12	16	0.750	19.05	1.302	33.07	2200
TS17B	TS17A	1-7/16" - 12	17	0.750	19.05	1.432	36.37	2000
TS20B	TS20A	1-5/8" - 12	20	0.825	20.96	1.615	41.02	1300
TS21B	TS21A	1-11/16" - 12	21	0.825	20.96	1.668	42.37	1200
TS24B	TS24A	1-7/8" - 12	24	0.950	24.13	1.871	47.52	900
TS32B	TS32A	2-1/2" - 12	32	1.200	30.48	2.491	63.27	400

Y Series Tear Tab Caps for NPT Threads

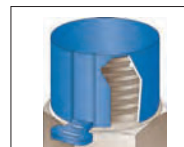
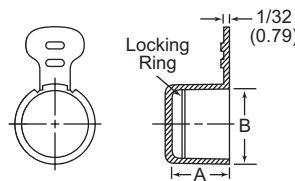

Specifications:

- Material: Low-Density Polyethylene
- Color: See Table

Features:

- Designed with a tear tab for easy removal
- Made to protect NPT threads from damage but versatile enough to be used in numerous applications

See pages 64 and 65 for Application Wizards

Item No.		To Cap NPT Thread	A		B		Bulk Pack Qty
Natural	Blue		in	mm	in	mm	
Y1/8B	Y1/8A	1/8	0.320	8.13	0.386	9.80	5000
Y1/4N	Y1/4A	1/4	0.490	12.45	0.531	13.49	4000
Y3/8B	Y3/8A	3/8	0.490	12.45	0.665	16.89	5500
Y1/2B	Y1/2A	1/2	0.640	16.26	0.817	20.75	5500
Y3/4D	Y3/4A	3/4	0.630	16.00	1.033	26.24	4000
Y1B	Y1A	1	0.785	19.94	1.305	33.15	2000
Y1-1/4N	Y1-1/4A	1 - 1/4	0.840	21.34	1.643	41.73	1300
Y1-1/2E	Y1-1/2A	1 - 1/2	0.850	21.59	1.884	47.85	1000
Y2B	Y2A	2	0.890	22.61	2.339	59.41	600
Y2-1/2N	---	2 - 1/2	1.375	34.93	2.850	72.39	500
Y3N	---	3	1.437	36.50	3.475	88.27	250
Y3-1/2N	---	3 - 1/2	1.500	38.10	3.980	101.09	200
Y4N	---	4	1.500	38.10	4.480	113.79	150
Y5N	---	5	1.625	41.28	5.535	140.59	100
Y6N	---	6	1.700	43.18	6.600	167.64	50

PUSH-FIT CAPS FOR THREADS



TSM Series

Tear Tab Caps for Metric Threads

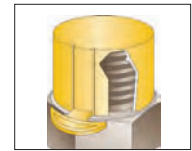
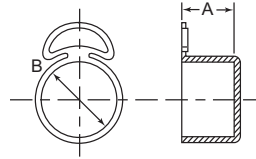

Specifications:

- Material: Low-Density Polyethylene
- Color: Refer to Chart

Features:

- Designed with a tear tab for easy removal
- Made to protect metric threads from damage but versatile enough to be used in numerous applications

Item No.	To Cap Metric Thread	A		B		Color	Bulk Pack Qty
		in	mm	in	mm		
TSM12A	M12	0.472	12.00	0.472	12.00	Yellow	5000
TSM14A	M14	0.551	14.00	0.555	14.10	Yellow	5000
TSM16A	M16	0.634	16.10	0.650	16.50	Yellow	5000
TSM18A	M18	0.709	18.00	0.709	18.00	Yellow	4000
TSM20B	M20	0.787	20.00	0.787	20.00	Natural	2000
TSM22A	M22	0.866	22.00	0.866	22.00	Yellow	2000

TSB Series

Tear Tab Caps for BSP Threads

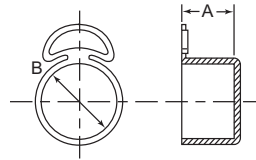

Specifications:

- Material: Low-Density Polyethylene
- Color: Yellow

Features:

- Designed with a tear tab for easy removal
- Made to protect BSP/Gas threads from damage but versatile enough to be used in numerous applications

Item No.	To Cap BSP/Gas Thread	A		B		Bulk Pack Qty
		in	mm	in	mm	
TSB10351A	1/4" x 19	0.433	11.00	0.512	13.00	10000
TSB10492A	3/8" x 19	0.472	12.00	0.630	16.00	5000
TSB10308A	1/2" x 14	0.591	15.00	0.835	21.20	4000
TSB12373A	5/8" x 14	0.728	18.50	0.906	23.00	3000
TSB10701A	3/4" x 14	0.937	23.80	1.035	26.30	1500
TSB12375A	7/8" x 14	0.984	25.00	1.161	29.50	1500
TSB12376A	1" x 11	0.709	18.00	1.339	34.00	1500

HEX Series

Hexagonal Caps

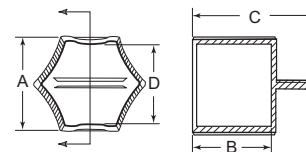

Specifications:

- Material: Polyethylene
- Color: Natural

Features:

- Rigid design allows easy application and removal
- Available in all common hydraulic coupling sizes
- Also suitable for protecting round components

Item No.	To Fit Thread Sizes			A		B		C		D		Bulk Pack Qty
	UNF	Metric	BSP	in	mm	in	mm	in	mm	in	mm	
HEX100A	—	M10	—	0.433	11	0.630	16	1.102	28	0.421	10.7	500
HEX105A	7/16	M12	1/8	0.551	14	0.709	18	1.181	30	0.539	13.7	500
HEX110A	—	—	—	0.630	16	0.787	20	1.260	32	0.618	15.7	500
HEX115A	1/2	M14	—	0.669	17	0.787	20	1.260	32	0.657	16.7	500
HEX120A	9/16	M16	1/4	0.748	19	0.984	25	1.535	39	0.736	18.7	500
HEX125A	3/4	M18	3/8	0.866	22	0.984	25	1.535	39	0.850	21.6	500
HEX130A	—	—	—	0.945	24	1.102	28	1.654	42	0.929	23.6	500
HEX135A	—	—	—	0.984	25	1.102	28	1.654	42	0.969	24.6	250
HEX140A	7/8	M22	1/2	1.063	27	1.102	28	1.654	42	1.047	26.6	250
HEX145A	—	—	—	1.142	29	1.181	30	1.732	44	1.126	28.6	250
HEX150A	—	M24	5/8	1.181	30	1.181	30	1.732	44	1.165	29.6	250
HEX155A	1 - 1/16	M26	3/4	1.260	32	1.181	30	1.732	44	1.244	31.6	250
HEX160A	—	M30	—	1.417	36	1.181	30	1.732	44	1.398	35.5	250
HEX165A	—	—	—	1.496	38	1.220	31	1.772	45	1.476	37.5	100
HEX170A	1 - 5/16	M36	1	1.614	41	1.220	31	1.772	45	1.594	40.5	100
HEX175A	—	—	—	1.811	46	1.260	32	1.811	46	1.791	45.5	100
HEX180A	1 - 5/8	M45	1 - 1/4	1.969	50	1.260	32	1.811	46	1.949	49.5	100



PUSH-FIT CAPS FOR THREADS

FC CAP Series Circular Connector Caps

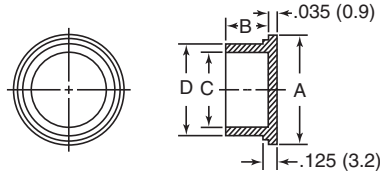

Specifications:

- Material: Low-Density Polyethylene
- Color: Red

Features:

- Designed for easy assembly and removal either with automated equipment or by hand
- Typically used to protect electrical connectors per Mil Spec 90376
- See page 47 if plug is needed

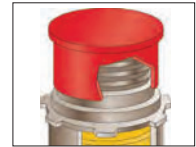

Item No.	MS90376 Dash No.	To Cap Connector	A		B		C		D		Bulk Pack Qty
			in	mm	in	mm	in	mm	in	mm	
FC708A	MS90376-8R	1/2	0.740	18.80	0.500	12.70	0.480	12.19	0.540	13.72	5000
FC710A	MS90376-10R	5/8	0.840	21.34	0.500	12.70	0.605	15.37	0.665	16.89	6000
FC712A	MS90376-12R	3/4	0.970	24.62	0.500	12.70	0.720	18.29	0.775	19.69	5500
FC714A	MS90376-14R	7/8	1.125	28.58	0.500	12.70	0.850	21.59	0.905	22.99	3000
FC716A	MS90376-16R	1	1.220	30.99	0.500	12.70	0.973	24.71	1.035	26.29	3300
FC718A	MS90376-18R	1 - 1/8	1.330	33.78	0.562	14.27	1.093	27.76	1.155	29.34	2500
FC19RA	MS90376-19R	1 - 3/16	1.430	36.32	0.562	14.27	1.168	29.67	1.238	31.45	2300
FC720A	MS90376-20R	1 - 1/4	1.465	37.21	0.562	14.27	1.231	31.27	1.301	33.05	2200
FC722A	MS90376-22R	1 - 3/8	1.580	40.39	0.562	14.27	1.340	34.04	1.410	35.81	1800
FC23RA	MS90376-23R	1 - 7/16	1.650	41.91	0.562	14.27	1.408	35.76	1.478	37.54	1200
FC724A	MS90376-24R	1 - 1/2	1.709	43.41	0.562	14.27	1.463	37.16	1.533	38.94	1500
FC726A	MS90376-26R	1 - 5/8	1.810	45.97	0.562	14.27	1.590	40.39	1.660	42.16	1250
FC728A	MS90376-28R	1 - 3/4	1.950	49.53	0.562	14.27	1.715	43.56	1.790	45.47	1000
FC732A	MS90376-32R	2	2.220	56.39	0.562	14.27	1.965	49.91	2.040	51.82	900
FC736A	MS90376-36R	2 - 1/4	2.435	61.85	0.600	15.24	2.215	56.26	2.290	58.17	700
FC740A	MS90376-40R	2 - 1/2	2.660	67.56	0.600	15.24	2.440	61.98	2.530	64.26	550
FC744A	MS90376-44R	2 - 3/4	2.960	75.18	0.600	15.24	2.720	69.09	2.812	71.42	450

D Series Flanged Connector Caps

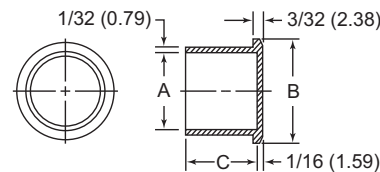

Specifications:

- Material: Low-Density Polyethylene
- Color: Red

Features:

- Designed for easy assembly and removal either with automated equipment or by hand
- Typically used to protect connectors with standard threads



Item No.	To Cap Std. Threaded Connector	A		B		C		Bulk Pack Qty
		in	mm	in	mm	in	mm	
D1/4A	1/4	0.240	6.10	0.480	12.19	0.500	12.70	5000
D3/8A	3/8	0.360	9.14	0.625	15.88	0.500	12.70	5000
D1/2A	1/2	0.477	12.12	0.750	19.05	0.500	12.70	7000
D9/16A	9/16	0.551	14.00	0.781	19.84	0.500	12.70	6000
D5/8A	5/8	0.593	15.06	0.875	22.23	0.500	12.70	4500
D3/4A	3/4	0.716	18.19	1.000	25.40	0.487	12.37	3500
D7/8A	7/8	0.841	21.36	1.125	28.58	0.491	12.47	2500
D15/16A	15/16	0.930	23.62	1.156	29.36	0.547	13.89	2000
D1A	1	0.960	24.38	1.250	31.75	0.500	12.70	2000
D1-1/8A	1 - 1/8	1.092	27.74	1.375	34.93	0.563	14.29	1500
D1-3/16A	1 - 3/16	1.176	29.87	1.438	36.51	0.563	14.29	3000
D1-1/4A	1 - 1/4	1.207	30.66	1.500	38.10	0.563	14.29	3000
D1-3/8A	1 - 3/8	1.348	34.24	1.625	41.28	0.563	14.29	2500
D1-7/16A	1 - 7/16	1.407	35.74	1.688	42.86	0.563	14.29	2200
D1-1/2A	1 - 1/2	1.458	37.03	1.719	43.66	0.563	14.29	2000
D1-3/4A	1 - 3/4	1.730	43.94	1.969	50.01	0.563	14.29	1500



OFR Series O-Ring Face-Fitting Caps for UNF/JIC Threads



Specifications:

- Material: Low-Density Polyethylene
- Color: See Table

Features:

- Designed to protect O-Ring face seal connectors used on hydraulic connections
- Designed with a longer overall length and includes a molded retaining ring at the bottom that snaps under the connector for added security

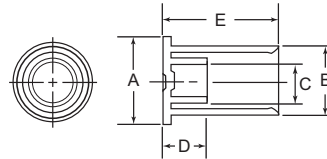

Item No.	To Cap UNF Thread	A		B		C		D		E		Bulk Pack Qty
		in	mm	in	mm	in	mm	in	mm	in	mm	
Blue												
OFR4B	9/16" - 18	0.938	23.80	0.771	19.58	0.500	12.70	0.330	8.30	0.690	17.50	3000
OFR6B	11/16" - 16	1.125	28.40	0.903	22.93	0.625	16.00	0.370	9.40	0.770	19.60	2500
OFR8A	13/16" - 16	1.219	31.00	1.052	26.72	0.750	19.10	0.430	10.90	0.930	23.60	3000
OFR10A	1" - 14	1.438	36.50	1.255	31.50	0.906	23.00	0.530	13.50	1.040	26.40	2000
OFR12A	1 - 3/16" - 12	1.688	42.70	1.530	38.86	1.093	27.70	0.570	14.50	1.140	28.80	1200
OFR16A	1 - 7/16" - 12	2.000	50.80	1.804	45.82	1.343	34.10	0.580	14.70	1.210	30.70	900
OFR20A	1 - 11/16" - 12	2.250	57.20	2.093	53.16	1.593	40.50	0.580	14.70	1.210	30.70	700
OFR24A	2" - 12	2.719	69.00	2.520	64.01	1.875	47.60	0.580	14.70	1.210	30.70	450

Item No.	To Cap JIC Thread	JIC Fitting Size	A		B		C		D		E		Bulk Pack Qty	
			in	mm	in	mm	in	mm	in	mm	in	mm		
Blue														
OFR100A	OFR100B	7/16" - 20	4	0.770	19.60	0.712	18.08	0.370	9.40	0.420	10.67	0.710	18.03	3000
OFR110A	OFR110B	9/16" - 18	6	0.950	24.10	0.864	21.95	0.500	12.80	0.420	10.67	0.840	21.34	2500
OFR120A	OFR120B	3/4" - 16	8	1.160	29.30	1.067	27.10	0.670	17.00	0.430	10.92	0.930	23.62	1200
OFR130A	OFR130B	7/8" - 14	10	1.280	32.50	1.192	30.28	0.780	19.80	0.500	12.70	1.050	26.67	1200
OFR140A	OFR140B	1 - 1/16" - 12	12	1.580	40.10	1.489	37.82	0.960	24.40	0.570	14.48	1.150	29.21	1200
OFR150A	OFR150B	1 - 5/16" - 12	16	1.880	47.80	1.766	44.86	1.220	30.90	0.590	14.99	1.210	30.73	1000

OR Series O-Ring Face-Fitting Caps for UNF Threads



Specifications:

- Material: Low-Density Polyethylene
- Color: Blue

Features:

- Designed to protect O-Ring face seal connectors used on hydraulic connections

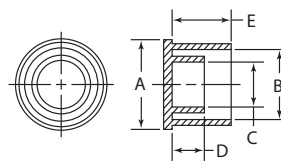

Item No.	To Cap UNF Thread	A		B		C		D		E		Bulk Pack Qty
		in	mm	in	mm	in	mm	in	mm	in	mm	
OR4A	9/16" - 18	0.875	22.23	0.768	19.51	0.500	12.70	0.326	8.28	0.578	14.68	3500
OR6A	11/16" - 16	1.000	25.40	0.901	22.89	0.594	15.08	0.370	9.40	0.672	17.07	2500
OR8A	13/16" - 16	1.156	29.37	1.053	26.75	0.750	19.05	0.430	10.92	0.828	21.03	3000
OR10A	1" - 14	1.375	34.93	1.260	32.00	0.906	23.02	0.530	13.46	0.922	23.42	2000
OR12A	1 - 3/16" - 12	1.625	41.28	1.535	38.99	1.094	27.78	0.560	14.48	1.031	26.19	1200
OR16A	1 - 7/16" - 12	1.844	46.83	1.804	45.82	1.344	34.13	0.580	14.73	1.094	27.78	900
OR20A	1 - 11/16" - 12	2.125	53.98	2.093	53.16	1.594	40.48	0.580	14.73	1.094	27.78	700
OR24B	2" - 12	2.688	68.26	2.520	64.01	1.875	47.63	0.580	14.73	1.094	27.78	450



PUSH-FIT CAPS

Hydraulic Quick Release Dust Caps

Specifications:

- Material: Thermoplastic Elastomer
- Color: See Table

Features:

- Suitable to cap ISO 7241-1 Series A and B Quick Couplings
- Designed to remain attached to a hose
- Excellent protection from dirt, moisture and corrosion
- Temperature Range: -40°F - 275°F (-40°C - 135°C)
- See page 51 if plug is needed

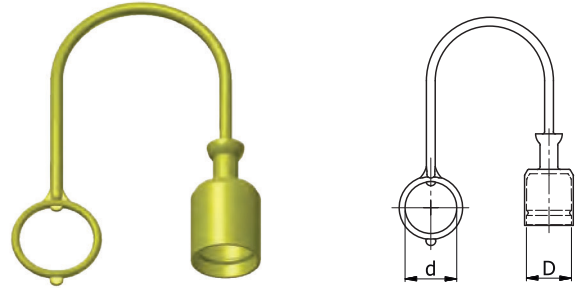

Item No.					D		d		Bulk Pack Qty	
Red	Yellow	Green	Blue	Size	Series	mm	in	mm	in	
498796	499736	499746	499756	1/4	ISO A	12.7	0.500	20.0	0.787	150
498797	499737	499747	499757	3/8	ISO A	18.3	0.720	25.0	0.984	150
498798	499738	499748	499758	1/2	ISO A	24.3	0.957	28.0	1.102	150
498799	499739	499749	499759	3/4	ISO A	30.7	1.209	35.0	1.378	150
498800	499740	499750	499760	1	ISO A	36.5	1.437	42.0	1.654	150
498801	499741	499751	499761	1/4	ISO B	15.5	0.610	20.0	0.787	150
498802	499742	499752	499762	3/8	ISO B	20.0	0.787	23.0	0.906	150
498803	499743	499753	499763	1/2	ISO B	25.7	1.012	28.0	1.102	150
498804	499744	499754	499764	3/4	ISO B	32.7	1.287	34.0	1.339	150
498805	499745	499755	499765	1	ISO B	40.5	1.594	43.0	1.693	150

M Series

Tube and Nut Assembly Caps

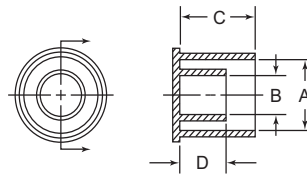

Specifications:

- Materials: Low-Density Polyethylene
- Color: Red

Features:

- Designed to protect flareless hydraulic tube and nut assemblies
- Features a double cap design; the outside cap conforms to the hex shape of the nut, the inside cap covers the tube and sleeve inside the nut to hold the assembly in place
- The MCA and MCM Series are frequently applied to automobile air conditioning tube and nut assemblies



Item No.	To Cap Tube Size	A		B		C		D		Bulk Pack Qty
		in	mm	in	mm	in	mm	in	mm	
M2A	1/8	0.391	9.93	0.172	4.37	0.580	14.73	0.400	10.16	6000
M3A	3/16	0.456	11.58	0.236	5.99	0.630	16.00	0.410	10.41	8500
M4A	1/4	0.606	15.39	0.283	7.19	0.650	16.51	0.380	9.65	5000
M5A	5/16	0.655	16.64	0.352	8.94	0.810	20.57	0.540	13.72	3500
M6A	3/8	0.740	18.80	0.440	11.18	0.845	21.46	0.545	13.84	2800
M8A	1/2	0.914	23.22	0.567	14.40	0.905	22.99	0.540	13.72	1800
M10A	5/8	1.044	26.52	0.670	17.02	1.030	26.16	0.647	16.43	2500
M12A	3/4	1.324	33.62	0.851	21.62	1.045	26.54	0.643	16.33	1600
M16A	1	1.564	39.73	1.060	26.92	1.097	27.86	0.550	13.97	1100
M20A	1 - 1/4	2.090	53.09	1.320	33.53	1.104	28.04	0.625	15.88	650
M24A	1 - 1/2	2.345	59.56	1.535	38.99	1.078	27.38	0.620	15.75	550
MCA10A	3/8 female	0.799	20.29	0.326	8.28	0.610	15.49	0.211	5.36	2800
MCA12A	1/2 female	0.930	23.62	0.450	11.43	0.750	19.05	0.315	8.00	3500
MCA17A	3/4 female	1.330	33.78	0.684	17.37	1.060	26.92	0.315	8.00	1500
MCM10A	3/8 male	0.612	15.54	0.326	8.28	0.800	20.32	0.211	5.36	3500
MCM12A	1/2 male	0.735	18.67	0.450	11.43	1.000	25.40	0.315	8.00	2000

W Series

Hose Washer Caps

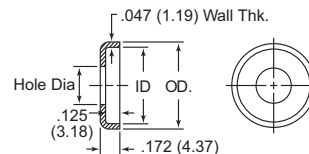

Specifications:

- Material: See Table
- Color: See Table

Features:

- Applied on hose and tube ends in order to prevent them from sliding over the fittings

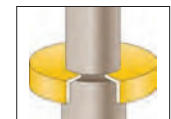

Item No.	Ø Hole		I.D.		O.D.		Color	Material	Bulk Pack Qty
	in	mm	in	mm	in	mm			
W6A	0.320	8.13	0.589	14.96	0.685	17.40	Yellow	LDPE	4750
W6C	0.320	8.13	0.589	14.96	0.685	17.40	Black	TPE	4750
W8A	0.445	11.30	0.760	19.30	0.860	21.84	Yellow	LDPE	4000
W8C	0.445	11.30	0.760	19.30	0.860	21.84	Black	TPE	4000
W10A	0.575	14.61	0.870	22.10	0.968	24.59	Yellow	LDPE	5000
W10C	0.575	14.61	0.870	22.10	0.968	24.59	Black	TPE	5000

Item No.	Ø Hole		I.D.		O.D.		Color	Material	Bulk Pack Qty
	in	mm	in	mm	in	mm			
W13A	0.700	17.78	1.040	26.42	1.141	28.98	Yellow	LDPE	7000
W13C	0.700	17.78	1.040	26.42	1.141	28.98	Black	TPE	6500
W15A	0.828	21.03	1.165	29.59	1.266	32.16	Yellow	LDPE	5000
W15C	0.828	21.03	1.165	29.59	1.266	32.16	Black	TPE	5000
W20A	1.050	26.67	1.300	33.02	1.400	35.56	Yellow	LDPE	5000
W20C	1.050	26.67	1.300	33.02	1.400	35.56	Black	TPE	5000



CAPS, PLUGS & NETTING
THREADED CAPS

TSC Series
UNF/Metric Threaded Sealing Caps



Specifications:

- Material: High-Density Polyethylene
- Color: Yellow

Features:

- This cap includes a neoprene sealing disk to limit fluid leakage
- The HDPE material reduces the potential of shearing

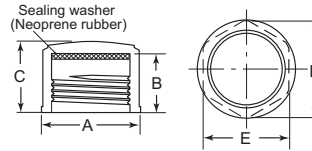

Unified Threads

Item No.	To Cap Thread Size	A		B		C		D		E		Bulk Pack Qty
		in	mm	in	mm	in	mm	in	mm	in	mm	
TSC467054A	1/4" - 28	0.393	10.00	0.452	11.50	0.531	13.50	0.346	8.80	0.314	8.00	500
TSC467055A	3/8" - 24	0.511	13.00	0.492	12.50	0.570	14.50	0.476	12.10	0.433	11.00	500
TSC467056A	7/16" - 24	0.610	15.50	0.492	12.50	0.570	14.50	0.562	14.30	0.511	13.00	500
TSC467057A	7/16" - 20	0.610	15.50	0.511	13.00	0.590	15.00	0.562	14.30	0.511	13.00	500
TSC467058A	1/4" - 28	0.689	17.50	0.511	13.00	0.590	15.00	0.649	16.50	0.590	15.00	500
TSC467059A	9/16" - 18	0.728	18.50	0.531	13.50	0.610	15.50	0.688	17.50	0.629	16.00	500
TSC467060A	5/8" - 18	0.826	21.00	0.531	13.50	0.610	15.50	0.775	19.70	0.708	18.00	500
TSC467061A	3/4" - 16	0.944	24.00	0.570	14.50	0.649	16.50	0.905	23.00	0.826	21.00	500
TSC467062A	13/16" - 16	1.043	26.50	0.570	14.50	0.649	16.50	0.992	25.20	0.905	23.00	500
TSC467063A	7/8" - 18	1.082	27.50	0.531	13.50	0.610	15.50	1.035	26.30	0.944	24.00	500
TSC467064A	7/8" - 14	1.082	27.50	0.610	15.50	0.688	17.50	1.035	26.30	0.944	24.00	250
TSC467065A	1" - 14	1.220	31.00	0.610	15.50	0.688	17.50	1.165	29.60	1.062	27.00	250
TSC467066A	1 - 1/16" - 12	1.358	34.50	0.649	16.50	0.728	18.50	1.295	32.90	1.181	30.00	250
TSC467067A	1 - 3/16" - 12	1.437	36.50	0.649	16.50	0.728	18.50	1.381	35.10	1.259	32.00	250
TSC467068A	1 - 5/16" - 12	1.614	41.00	0.649	16.50	0.728	18.50	1.555	39.50	1.417	36.00	250
TSC467069A	1 - 3/8" - 12	1.692	43.00	0.649	16.50	0.728	18.50	1.641	41.70	1.496	38.00	250
TSC467070A	1 - 7/16" - 12	1.791	45.50	0.649	16.50	0.728	18.50	1.728	43.90	1.574	40.00	250
TSC467071A	1 - 5/8" - 12	2.007	51.00	0.649	16.50	0.748	19.00	1.944	49.40	1.771	45.00	100
TSC467072A	1 - 3/4" - 16	2.145	54.50	0.570	14.50	0.669	17.00	2.070	52.60	1.889	48.00	100
TSC467073A	1-7/8" - 12	2.322	59.00	0.649	16.50	0.748	19.00	2.244	57.00	2.047	52.00	100

Metric Threads

Item No.	To Cap Thread Size	A		B		C		D		E		Bulk Pack Qty
		in	mm	in	mm	in	mm	in	mm	in	mm	
TSC467033A	M8 x 1	0.472	12.00	0.433	11.00	0.511	13.00	0.433	11.00	0.393	10.00	500
TSC467034A	M10 x 1	0.559	14.20	0.433	11.00	0.511	13.00	0.519	13.20	0.472	12.00	500
TSC467035A	M12 x 1	0.649	16.50	0.433	11.00	0.511	13.00	0.606	15.40	0.551	14.00	500
TSC467036A	M12 x 1.5	0.649	16.50	0.511	13.00	0.590	15.00	0.606	15.40	0.551	14.00	500
TSC467037A	M14 x 1.5	0.728	18.50	0.511	13.00	0.590	15.00	0.689	17.50	0.629	16.00	500
TSC467038A	M16 x 1.5	0.826	21.00	0.511	13.00	0.590	15.00	0.775	19.70	0.708	18.00	500
TSC467039A	M18 x 1.5	0.905	23.00	0.511	13.00	0.590	15.00	0.862	21.90	0.787	20.00	500
TSC467040A	M20 x 1.5	0.984	25.00	0.511	13.00	0.590	15.00	0.948	24.10	0.866	22.00	500
TSC467041A	M22 x 1.5	1.082	27.50	0.511	13.00	0.590	15.00	1.035	26.30	0.944	24.00	250
TSC467042A	M24 x 1.5	1.181	30.00	0.511	13.00	0.590	15.00	1.122	28.50	1.023	26.00	250
TSC467043A	M25 x 1.5	1.220	31.00	0.511	13.00	0.590	15.00	1.165	29.60	1.063	27.00	250
TSC467044A	M26 x 1.5	1.259	32.00	0.511	13.00	0.590	15.00	1.208	30.70	1.102	28.00	250
TSC467045A	M28 x 1.5	1.338	34.00	0.511	13.00	0.590	15.00	1.295	32.90	1.181	30.00	250
TSC467046A	M30 x 1.5	1.437	36.50	0.511	13.00	0.590	15.00	1.381	35.10	1.259	32.00	250
TSC467047A	M30 x 2	1.437	36.50	0.590	15.00	0.669	17.00	1.381	35.10	1.259	32.00	250
TSC467048A	M36 x 1.5	1.752	44.50	0.551	14.00	0.629	16.00	1.685	42.80	1.535	39.00	100
TSC467049A	M36 x 2	1.752	44.50	0.629	16.00	0.708	18.00	1.685	42.80	1.535	39.00	100
TSC467050A	M42 x 2	2.007	51.00	0.629	16.00	0.728	18.50	1.944	49.40	1.771	45.00	100
TSC467051A	M45 x 1.5	2.145	54.50	0.551	14.00	0.649	16.50	2.070	52.60	1.889	48.00	100
TSC467052A	M45 x 2	2.145	54.50	0.629	16.00	0.728	18.50	2.070	52.60	1.889	48.00	100
TSC467053A	M52 x 2	2.440	62.00	0.629	16.00	0.728	18.50	2.374	60.30	2.165	55.00	100



HOSE
PROTECTION

Wrap it. Cover it. Shield it. Secure it.

800 847 0486 | www.essentracomponents.com



SPIRALGUARD
www.spiralguard.com

FT Series
TPR, PVC & Vinyl Plugs

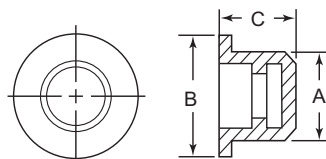

Specifications:

- Materials: Thermoplastic Rubber, PVC or Vinyl
- Color: See Table

Features:

- Highly resistant to shredding
- Ideal for threaded applications
- Thermoplastic rubber is recommended for use wherever resistance to acid is required
- PVC is highly resistant to shredding and ideal for threaded applications
- Green Vinyl works well with oils and greases



Item No.			A		B		C		Bulk Pack Qty		
Black TPR	Black PVC	Green Vinyl	in	mm	in	mm	in	mm	Black TPR	Black PVC	Green Vinyl
18071B	10874A	—	0.125	3.20	0.276	7.00	0.354	9.00	10000	10000	10000
12049B	12665A	—	0.197	5.00	0.433	11.00	0.471	11.99	10000	10000	10000
12050B	12666A	11806	0.236	5.99	0.472	11.99	0.471	11.99	10000	10000	5000
12051B	12667A	11817	0.275	6.99	0.511	12.98	0.471	11.99	10000	10000	5000
12052B	12668A	11808	0.315	8.00	0.551	14.00	0.471	11.99	10000	10000	10000
12053B	12669A	11829	0.354	8.99	0.580	14.99	0.471	11.99	10000	10000	5000
12054B	12670A	11807	0.393	9.98	0.629	15.98	0.471	11.99	10000	10000	5000
12055B	12671A	11824	0.433	11.00	0.669	16.99	0.471	11.99	10000	10000	10000
12056B	12672A	11809	0.472	11.99	0.787	19.99	0.471	11.99	8000	8000	8000
12057B	12673A	11822	0.511	12.98	0.826	20.98	0.551	14.00	8000	8000	8000
12058B	12674A	11813	0.551	14.00	0.866	22.00	0.551	14.00	6000	7000	7000
12059B	12675A	11830	0.580	14.99	0.905	22.99	0.571	14.50	6000	5000	6000
12060B	12677A	11820	0.630	16.00	0.945	24.00	0.551	14.00	6000	6000	6000
FLP17A	12678A	11811	0.669	17.00	1.063	27.00	0.531	13.50	4000	5000	5000
12062B	12679A	11827	0.709	18.01	1.102	27.99	0.551	14.00	4000	4000	4000
12063B	12680A	11818	0.748	19.00	1.142	29.01	0.551	14.00	4000	2000	2000
12064B	12681A	11812	0.787	19.99	1.181	30.00	0.551	14.00	4000	2000	2000
12065B	12683A	11823	0.827	21.01	1.220	30.99	0.551	14.00	3000	2500	3000
FLP21A	12684A	11828	0.879	22.33	1.260	32.00	0.551	14.00	2500	3000	1500
12067B	12685A	11814	0.906	23.01	1.299	32.99	0.630	16.00	3000	1500	1500
12068B	12686A	11810	0.945	24.00	1.339	34.01	0.630	16.00	2500	2500	2500
12069B	12687A	11816	0.984	24.99	1.378	35.00	0.630	16.00	2000	2000	2000
12070B	12688A	11819	1.024	26.01	1.417	35.99	0.630	16.00	2000	2000	2000
12071B	12689A	11821	1.063	27.00	1.457	37.01	0.630	16.00	2000	2000	2000
12072B	12690A	11825	1.102	27.99	1.496	38.00	0.630	16.00	2000	2000	2000
FLP30A	12692A	11826	1.190	30.23	1.400	35.56	0.630	16.00	1500	1000	1000
12501B	12693A	12078	1.575	40.01	1.969	50.01	0.866	22.00	700	500	700
12502B	12694A	—	1.850	46.99	2.244	57.00	0.866	22.00	500	500	500

DMVP Series
Vinyl Tapered Plugs

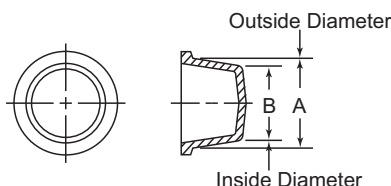

Specifications:

- Material: PVC
- Color: Black
- Temperature Range: Up to 350°F (177°C)

Features:

- The flexibility of the material allows these plugs to fit into smaller dimensions for a snug fit
- The tapered design allows the part to plug multiple inner diameters

To Assure Proper Fit:



Plug dimension "A" should be approx. 1% larger than the inner diameter of the part.
 Minimum of .020"

Item No.	A		B		Bulk Pack Qty
	in	mm	in	mm	
DMVP0285A	0.290	7.20	0.180	4.40	5000
DMVP0360A	0.360	9.10	0.250	6.40	5000
DMVP0405A	0.410	10.30	0.300	7.50	5000
DMVP0465A	0.470	11.80	0.360	9.00	5000
DMVP0530A	0.530	13.50	0.420	10.70	5000
DMVP0605A	0.610	15.40	0.500	12.60	5000
DMVP0750A	0.750	19.10	0.640	16.30	2000
DMVP0850A	0.850	21.60	0.740	18.80	2500
DMVP1015A	1.020	25.80	0.910	23.00	2500
DMVP1190A	1.190	30.20	1.060	27.40	2000



**CP Series
Center Pull Tab Plugs**

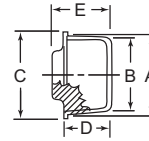
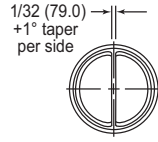

Specifications:

- Material: Low-Density Polyethylene
- Color: See Table

Features:

- The integral center pull tab feature is designed for quick and easy removal
- The tapered design allows the part to plug multiple inner diameters

To Assure Proper Fit:



Plug dimension "A" should be approx. 1% larger than the inner diameter of the part. Minimum of .020"

Item No.	A		B		C		D		E		Bulk Pack Qty	
Orange	Red	in	mm	in	mm	in	mm	in	mm	in	mm	
CP4A	—	0.269	6.83	0.209	5.31	0.380	9.65	0.340	8.64	0.590	14.99	5000
CP5A	—	0.303	7.69	0.239	6.07	0.469	11.91	0.370	9.39	0.630	16.00	5000
CP6A	—	0.335	8.51	0.267	6.78	0.469	11.91	0.406	10.32	0.625	15.88	5000
CP7A	—	0.370	9.40	0.302	7.67	0.531	13.49	0.375	9.53	0.750	19.05	5000
CP8A	—	0.396	10.06	0.330	8.38	0.530	13.46	0.410	10.41	0.790	20.07	5000
CP9A	—	0.428	10.87	0.362	9.19	0.594	15.08	0.375	9.53	0.750	19.05	7000
CP10A	—	0.463	11.76	0.402	10.21	0.625	15.88	0.375	9.53	0.750	19.05	6000
CP11A	—	0.486	12.34	0.422	10.72	0.625	15.88	0.406	10.32	0.781	19.84	5500
CP12A	—	0.512	13.00	0.448	11.38	0.656	16.67	0.406	10.32	0.563	14.29	5000
—	110033	0.539	13.70	0.461	11.70	0.677	17.20	0.433	11.00	0.866	22.00	5000
—	—	0.548	13.92	0.471	11.96	0.690	17.53	0.470	11.94	0.850	21.59	5000
CP13A	—	0.568	14.43	0.500	12.70	0.719	18.26	0.469	11.91	0.813	20.64	7500
CP14A	—	0.608	15.44	0.532	13.51	0.750	19.05	0.470	11.94	0.780	19.81	6000
CP15B	—	0.633	16.08	0.551	14.00	0.790	19.81	0.500	12.70	0.750	19.05	5000
CP16A	—	0.668	16.97	0.580	14.73	0.813	20.64	0.531	13.49	0.750	19.05	5500
CP18A	—	0.695	17.65	0.610	15.49	0.840	21.34	0.530	13.46	0.780	19.81	5000
CP19A	—	0.720	18.30	0.646	16.40	0.874	22.20	0.484	12.30	0.925	23.50	5000
—	110035	0.787	19.99	0.691	17.55	0.938	23.81	0.594	15.08	0.750	19.05	3500
CP23A	—	0.825	20.96	0.727	18.47	1.000	25.40	0.590	14.99	0.840	21.34	5000
CP24A	—	0.933	23.70	0.819	20.80	1.125	28.58	0.750	19.05	1.000	25.40	4000
CP29A	—	0.973	24.71	0.869	22.07	1.120	28.45	0.750	19.05	1.000	25.40	4000
CP31A	—	1.004	25.50	0.886	22.50	1.138	28.90	0.701	17.80	1.142	29.00	2500
—	10418	1.074	27.28	0.935	23.75	1.156	29.37	0.750	19.05	0.938	23.81	3500
CP35A	—	1.092	27.74	0.967	24.56	1.250	31.75	0.780	19.81	1.030	26.16	2500
CP37A	—	1.146	29.11	1.026	26.06	1.340	34.04	0.750	19.05	1.000	25.40	2500
CP40A	—	1.219	30.96	1.093	27.76	1.410	35.81	0.780	19.81	1.000	25.40	2500
CP42A	—	1.286	32.66	1.150	29.21	1.550	39.37	0.750	19.05	1.000	25.40	2000
CP44A	—	1.360	34.54	1.235	31.37	1.530	38.86	0.750	19.05	1.000	25.40	2000
CP46A	—	1.356	33.22	1.292	32.82	1.500	38.10	0.781	19.84	1.000	25.40	1800
CP47A	—	1.465	37.21	1.312	33.32	1.620	41.15	0.750	19.05	1.000	25.40	1800
CP49A	—	1.527	38.79	1.344	34.14	1.750	44.45	0.880	22.35	1.000	25.40	1500
CP51A	—	1.601	40.67	1.451	36.86	1.750	44.45	0.750	19.05	1.000	25.40	1500
CP55A	—	1.735	44.07	1.615	41.02	1.906	48.42	0.719	18.26	1.125	28.58	1000
CP56A	—	1.835	46.61	1.820	46.23	2.031	51.59	0.500	12.70	0.750	19.05	1500
CP59A	—	1.938	49.23	1.807	45.90	2.160	54.86	1.000	25.40	1.250	31.75	1000
CP57A	—	2.075	52.70	1.898	48.20	2.248	57.10	1.000	25.40	1.039	26.40	300
—	110039	2.243	56.97	2.067	52.50	2.440	61.98	1.030	26.16	1.250	31.75	1000
CP61A	—	2.270	57.66	2.230	56.64	2.530	64.26	0.500	12.70	0.750	19.05	1000
CP63A	—	2.402	61.00	2.165	55.00	2.559	65.00	0.984	25.00	1.024	26.00	400
CP65A	—	2.464	62.59	2.300	58.42	2.660	67.56	1.000	25.40	1.250	31.75	500
—	110041	2.650	67.30	2.335	59.30	2.780	70.60	1.209	30.70	1.240	31.50	150
—	110042	2.764	70.20	2.654	67.40	2.937	74.60	0.984	25.00	1.024	26.00	300
CP71A	—	3.452	87.68	3.320	84.33	3.620	91.95	0.750	19.05	1.000	25.40	200

Tapered Plug with Ring Tab

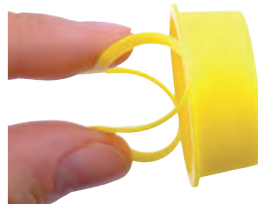

Specifications:

- Material: Low-Density Polyethylene
- Color: Yellow

Features:

- Tapered profile for extended dimensions
- Easy removal of the part with strong ring tab

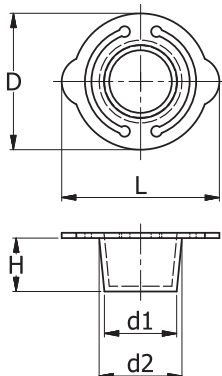

Item No.	d1		d2		H		D		L		Bulk Pack Qty
	mm	in	mm	in	mm	in	mm	in	mm	in	
498716	5.0	0.197	7.0	0.276	9.5	0.374	17.3	0.681	20.3	0.799	1000
498717	6.0	0.236	8.0	0.315	9.5	0.374	18.2	0.717	21.1	0.831	1000
498718	7.0	0.276	9.5	0.374	9.5	0.374	20.3	0.799	23.3	0.917	1000
498719	8.0	0.315	10.0	0.394	9.5	0.374	20.3	0.799	23.2	0.913	1000
498720	9.5	0.374	11.5	0.453	9.5	0.374	21.9	0.862	24.8	0.976	1000
498721	10.5	0.413	12.5	0.492	9.5	0.374	22.6	0.890	26.5	1.043	1000
498722	11.5	0.453	13.5	0.531	9.5	0.374	23.7	0.933	27.5	1.083	1000
498723	12.5	0.492	14.5	0.571	10.0	0.394	24.5	0.965	28.4	1.118	1000
498724	13.5	0.531	15.5	0.61	10.0	0.394	25.5	1.004	29.5	1.161	1000
498725	14.2	0.559	16.2	0.638	10.0	0.394	26.3	1.035	30.3	1.193	1000
498726	14.5	0.571	17.0	0.669	10.0	0.394	27.0	1.063	31.0	1.220	500
498727	15.5	0.610	18.0	0.709	10.0	0.394	28.3	1.114	32.0	1.260	500
498728	17.5	0.689	19.5	0.768	10.0	0.394	30.0	1.181	34.0	1.339	500
498729	18.0	0.709	20.0	0.787	10.0	0.394	30.0	1.181	34.0	1.339	500
498730	19.0	0.748	21.5	0.846	11.0	0.433	32.0	1.260	35.7	1.406	500
498731	21.0	0.827	24.2	0.953	11.0	0.433	34.7	1.366	38.7	1.524	500
498732	22.5	0.886	25.5	1.004	12.0	0.472	36.0	1.417	40.0	1.575	500
498733	25.0	0.984	28.0	1.102	12.0	0.472	38.5	1.516	42.2	1.661	500
498734	29.0	1.142	31.5	1.240	12.0	0.472	41.8	1.646	47.0	1.850	500
498735	29.5	1.161	32.0	1.260	12.0	0.472	42.5	1.673	47.6	1.874	500



PUSH-FIT PLUGS

P Series Side Pull Tab Plugs

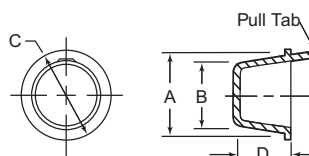

Specifications:

- Material: Low-Density Polyethylene
- Color: Blue

Features:

- The integral side pull tab feature is designed for easy removal in awkward locations
- The tapered design allows the part to plug multiple inner diameters

Item No.	A		B		C		D		Bulk Pack Qty
	in	mm	in	mm	in	mm	in	mm	
P7A	0.365	9.27	0.300	7.62	0.531	13.49	0.375	9.53	5000
P8A	0.398	10.11	0.330	8.38	0.563	14.30	0.375	9.53	5000
P11A	0.485	12.32	0.420	10.67	0.594	15.08	0.375	9.53	5000
P13A	0.548	13.92	0.471	11.96	0.690	17.53	0.470	11.94	5000
P16A	0.623	15.82	0.531	13.49	0.750	19.05	0.500	12.70	7000
P17A	0.634	16.10	0.550	13.97	0.781	19.84	0.500	12.70	7000
P18A	0.668	16.97	0.580	14.73	0.810	20.57	0.530	13.46	5000
P20A	0.729	18.52	0.640	16.26	0.880	22.35	0.500	12.70	5000
P23A	0.785	19.94	0.690	17.53	0.937	23.81	0.625	15.88	3500
P24A	0.805	20.44	0.717	18.21	0.937	23.81	0.625	15.88	5000
P26A	0.912	23.16	0.802	20.37	1.060	26.92	0.650	16.51	5000
P27A	0.933	23.70	0.815	20.70	1.120	28.45	0.620	15.75	5000
P31A	0.975	24.77	0.870	22.10	1.125	28.58	0.625	15.88	2500
P33A	1.040	26.42	0.915	23.24	1.160	29.46	0.720	18.29	5000
P40A	1.090	27.69	0.964	24.49	1.250	31.75	0.780	19.81	3000
P41A	1.145	29.08	0.995	25.27	1.310	33.27	0.780	19.81	2500
P42A	1.230	31.24	1.110	28.19	1.516	38.50	0.750	19.05	2500
P44A	1.275	32.39	1.165	29.59	1.405	35.69	0.750	19.05	2500
P46A	1.360	34.54	1.233	31.32	1.500	38.10	0.840	21.34	2500
P53A	1.600	40.64	1.450	36.83	1.750	44.45	0.750	19.05	2000
P55A	1.682	42.74	1.560	39.62	1.875	47.63	0.750	19.05	1500
P57A	1.750	44.45	1.633	41.48	1.940	49.28	0.750	19.05	1000
P59A	1.825	46.36	1.800	45.72	2.031	51.59	0.500	12.70	2000
P61A	1.950	49.53	1.780	45.21	2.120	53.85	1.000	25.40	1000
P63A	2.000	50.80	1.844	46.84	2.120	53.85	1.000	25.40	1000
P65A	2.083	52.91	1.920	48.77	2.250	57.15	1.000	25.40	1000
P68A	2.261	57.43	2.231	56.67	2.500	63.50	0.500	12.70	1000

Tapered Plugs with Lateral Pull Tabs

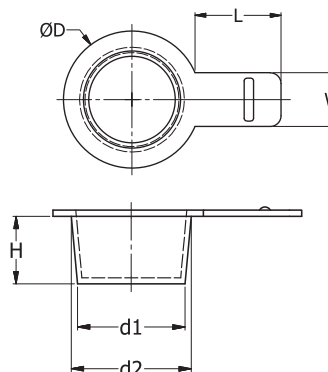

Specifications:

- Material: Thermoplastic Rubber
- Color: White

Features:

- The soft and flexible material provides a close fit
- The lateral pull tab makes for easy removal
- TPR is recommended wherever resistance to acid is required

Item No.	d1		d2		D		H		W		L		Bulk Pack Qty
	mm	in	mm	in	mm	in	mm	in	mm	in	mm	in	
494297	5.0	0.197	7.0	0.276	11.0	0.433	9.5	0.374	7.0	0.276	15.0	0.591	5000
494298	6.0	0.236	8.0	0.315	12.0	0.472	9.5	0.374	7.0	0.276	15.0	0.591	5000
494299	7.0	0.276	9.5	0.374	13.5	0.531	9.5	0.374	7.0	0.276	15.0	0.591	5000
494300	8.0	0.315	10.0	0.394	14.0	0.551	9.5	0.374	8.0	0.315	15.0	0.591	5000
494301	9.5	0.374	11.5	0.453	15.5	0.610	9.5	0.374	8.0	0.315	15.0	0.591	5000
494302	10.5	0.413	12.5	0.492	16.5	0.650	9.5	0.374	8.0	0.315	15.0	0.591	5000
494303	11.5	0.453	13.5	0.531	17.5	0.689	9.5	0.374	8.0	0.315	15.0	0.591	5000
494304	12.5	0.492	14.5	0.571	18.5	0.728	10.0	0.394	8.0	0.315	15.0	0.591	5000
494305	13.5	0.531	15.5	0.610	19.5	0.768	10.0	0.394	10.0	0.394	15.0	0.591	5000
494306	14.2	0.559	16.2	0.638	20.2	0.795	10.0	0.394	10.0	0.394	15.0	0.591	5000
494307	14.5	0.571	17.0	0.669	21.0	0.827	10.0	0.394	10.0	0.394	15.0	0.591	2000
494308	15.5	0.61	18.0	0.709	22.0	0.866	10.0	0.394	10.0	0.394	15.0	0.591	2000
494309	17.5	0.689	19.5	0.768	23.5	0.925	10.0	0.394	10.0	0.394	15.0	0.591	2000
494310	19.0	0.748	21.5	0.846	25.5	1.004	11.0	0.433	10.0	0.394	15.0	0.591	2000
494311	21.0	0.827	23.5	0.925	27.5	1.083	11.0	0.433	10.0	0.394	15.0	0.591	2000
494312	22.5	0.886	25.5	1.004	29.5	1.161	12.0	0.472	12.0	0.472	15.0	0.591	2000
494313	25.0	0.984	28.0	1.102	32.0	1.260	12.0	0.472	12.0	0.472	15.0	0.591	2000
494314	29.0	1.142	31.5	1.240	35.5	1.398	12.0	0.472	12.0	0.472	15.0	0.591	2000



S Series
Sheet Metal Plugs

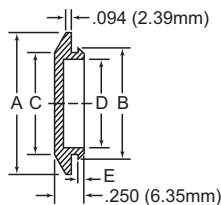

Specifications:

- Material: Low-Density Polyethylene
- Color: Black

Features:

- Economical snap-in plug that provides an attractive finish and a secure fit for entry holes in sheet metal

Item No.	Ø Hole		Max Panel Thickness		A		B		C		D		E		Bulk Pack Qty
	in	mm	in	mm	in	mm	in	mm	in	mm	in	mm	in	mm	
S1/4A	0.250	0.110	2.79	0.500	12.70	0.280	7.11	0.250	6.35	0.188	4.78	0.250	6.35	5000	
SM3/8A	0.375	0.065	1.65	0.740	18.80	0.400	10.16	0.370	9.40	0.240	6.10	0.250	6.35	5000	
S3/8A	0.375	0.110	2.79	0.730	18.54	0.412	10.46	0.370	9.40	0.270	6.86	0.110	2.79	5000	
S7/16A	0.438	0.110	2.79	0.688	17.48	0.471	11.96	0.438	11.13	0.375	9.53	0.250	6.35	6000	
S1/2A	0.500	0.075	1.91	0.875	22.23	0.570	14.48	0.510	12.95	0.375	9.53	0.115	2.92	6000	
S9/16A	0.563	0.110	2.79	0.813	20.64	0.600	15.24	0.563	14.3	0.500	12.70	0.250	6.35	6000	
S5/8A	0.625	0.075	1.91	0.813	20.65	0.670	17.02	0.620	15.75	0.540	13.72	0.100	2.54	6000	
S11/16A	0.688	0.110	2.79	1.000	25.40	0.720	18.29	0.688	17.48	0.925	23.50	0.250	6.35	5000	
SM3/4A	0.750	0.094	2.39	1.120	28.45	0.810	20.57	0.760	19.30	0.610	15.49	0.250	6.35	5000	
S3/4A	0.750	0.110	2.79	1.125	28.58	0.790	20.07	0.760	19.30	0.623	15.82	0.115	2.92	6500	
S13/16A	0.813	0.110	2.79	1.125	28.58	0.845	21.46	0.813	20.65	0.750	19.05	0.250	6.35	5000	
S7/8A	0.875	0.110	2.79	1.250	31.75	0.900	22.86	0.870	22.10	0.745	18.92	0.094	2.39	5000	
S15/16A	0.937	0.111	2.80	1.251	31.76	0.980	24.9	0.937	23.8	0.875	22.23	0.250	6.35	5000	
S1A	1.000	0.110	2.79	1.438	36.53	1.040	26.42	1.010	25.65	0.875	22.23	0.110	2.79	3500	
S1-3/32A	1.094	0.110	2.79	1.375	34.93	1.150	29.21	1.094	27.79	1.031	26.19	0.250	6.35	4000	
S1-1/8A	1.125	0.110	2.79	1.500	38.10	1.180	29.97	1.125	28.58	1.063	27.00	0.250	6.35	3000	
S1-5/16A	1.313	0.110	2.79	1.688	42.88	1.360	34.54	1.313	33.35	1.250	31.75	0.250	6.35	2500	
S1-1/2A	1.500	0.110	2.79	1.875	47.63	1.540	39.12	1.500	38.10	1.400	35.56	0.110	2.79	2000	
S1-3/4A	1.750	0.110	2.79	2.130	54.10	1.835	46.61	1.730	43.94	1.610	40.89	0.105	2.67	1500	
S2A	2.000	0.110	2.79	2.375	60.33	2.060	52.32	2.000	50.80	1.938	49.23	0.250	6.35	1000	
S2-1/8A	2.125	0.110	2.79	2.500	63.50	2.175	55.25	2.125	53.98	2.063	52.40	0.250	6.35	1000	
S2-1/2A	2.500	0.110	2.79	3.000	76.20	2.560	65.02	2.500	63.50	2.438	61.93	0.250	6.35	700	
S2-5/8A	2.625	0.110	2.79	3.125	79.38	2.685	68.20	2.625	66.68	2.563	65.10	0.250	6.35	1200	
S3A	3.000	0.110	2.79	3.375	85.73	3.060	77.72	3.000	76.20	2.938	74.63	0.250	6.35	1000	
S3-3/8A	3.375	0.110	2.79	3.750	95.25	3.435	87.25	3.375	85.73	3.313	84.15	0.250	6.35	500	
S3-1/2A	3.500	0.110	2.79	3.875	98.43	3.560	90.42	3.500	88.90	3.438	87.33	0.250	6.35	600	

SR Series
Recessed Sheet Metal Plugs

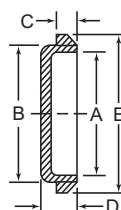

Specifications:

- Material: Low-Density Polyethylene
- Color: Black

Features:

- Economical snap-in plug that provides an attractive finish and a secure fit for entry holes in sheet metal

Item No.	Ø Hole		Max Panel Thickness		A		B		C		D		E		Bulk Pack Qty
	in	mm	in	mm	in	mm	in	mm	in	mm	in	mm	in	mm	
SR1/2A	0.500	0.110	2.79	0.510	12.95	0.550	13.97	0.090	2.29	0.290	7.37	0.850	21.59	3000	
SR3/4A	0.750	0.180	4.57	0.750	19.05	0.800	20.32	0.190	4.83	0.380	9.65	1.156	29.36	4000	
SR7/8A	0.875	0.180	4.57	0.875	22.23	0.920	23.37	0.190	4.83	0.380	9.65	1.250	31.75	3500	
SR1A	1.000	0.150	3.81	1.000	25.40	1.043	26.49	0.096	2.44	0.319	8.10	1.377	34.98	3500	
SR1-1/4A	1.250	0.120	3.04	1.280	32.51	1.330	33.78	0.120	3.05	0.350	8.89	1.615	41.02	2000	
SR1-3/8A	1.375	0.190	4.82	1.375	34.93	1.437	36.50	0.200	5.08	0.410	10.41	1.750	44.45	1800	
SR1-1/2A	1.500	0.125	3.17	1.515	38.48	1.555	39.50	0.120	3.05	0.350	8.89	1.875	47.63	1500	
SR1-5/8A	1.625	0.190	4.82	1.625	41.28	1.688	42.88	0.200	5.08	0.410	10.41	2.000	50.80	1000	
SR1-3/4A	1.750	0.190	4.82	1.750	44.45	1.812	46.02	0.200	5.08	0.410	10.41	2.125	53.98	1000	
SR1-7/8A	1.875	0.190	4.82	1.875	47.63	1.937	49.20	0.200	5.08	0.410	10.41	2.250	57.15	900	
SR2A	2.000	0.190	4.82	2.000	50.80	2.060	52.32	0.170	4.32	0.390	9.91	2.500	63.50	800	
SR3A	3.000	0.190	4.82	3.000	76.20	3.065	77.85	0.200	5.08	0.410	10.41	3.500	88.90	300	



SHEET METAL PLUGS

Blanking Plug Series PVC & TPE Hole Plugs

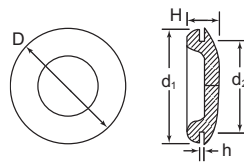

Specifications:

- Material: See Table
- Color: Black

Features:

- PVC Material: Non-staining; resistant to ozone, acids, and sunlight; with excellent aging qualities
- TPE Material: Very resistant to oils, acids and alkalies
- Resistant to temperatures up to 203°F (95°C)

Item No.		Ø Hole d2		Max Panel Thickness h		D= OD		Depth H		d1		Bulk Pack Qty
		in	mm	in	mm	in	mm	in	mm	in	mm	
10860B	15150B	0.187	4.70	0.063	1.60	0.366	9.30	0.181	4.60	0.366	9.30	10000
10825B	15151B	0.250	6.40	0.063	1.60	0.374	9.50	0.197	5.00	0.374	9.50	10000
10832B	—	0.313	8.00	0.031	0.80	0.571	14.50	0.157	4.00	0.417	10.60	10000
10233B	—	0.313	8.00	0.063	1.60	0.571	14.50	0.177	4.50	0.417	10.60	10000
10488B	—	0.354	9.00	0.063	1.60	0.591	15.00	0.260	6.60	0.488	12.40	10000
10912B	15155B	0.438	11.10	0.063	1.60	0.697	17.70	0.244	6.20	0.504	12.80	10000
10768B	—	0.453	11.50	0.063	1.60	0.669	17.00	0.276	7.00	0.610	15.50	5000
15511B	—	0.469	11.90	0.047	1.20	0.689	17.50	0.280	7.10	0.626	15.90	10000
10502B	15157B	0.500	12.70	0.063	1.60	0.736	18.70	0.220	5.60	0.610	15.50	5000
11321B	15158B	0.587	14.90	0.051	1.30	0.787	20.00	0.276	7.00	0.724	18.40	10000
10213B	15159B	0.610	15.50	0.063	1.60	0.866	22.00	0.295	7.50	0.748	19.00	5000
40043B	—	0.625	15.90	0.063	1.60	0.748	19.00	0.280	7.10	0.748	19.00	10000
12914B	—	0.642	16.30	0.051	1.30	0.787	20.00	0.276	7.00	0.728	18.50	5000
10678B	15160B	0.750	19.00	0.063	1.60	0.984	25.00	0.256	6.50	0.846	21.50	5000
10499A	15161B	0.781	20.00	0.063	1.60	0.984	25.00	0.256	6.50	0.846	21.50	5000
11152B	15162B	0.866	22.00	0.094	2.40	1.122	28.50	0.323	8.20	1.047	26.60	3000
10902B	—	0.875	22.50	0.063	1.60	1.122	28.50	0.295	7.50	1.063	27.00	3000
11027B	15164B	0.968	24.50	0.094	2.40	1.181	30.00	0.343	8.70	1.083	27.50	2000
11323B	—	0.984	25.00	0.031	0.80	1.516	38.50	0.181	4.60	1.122	28.50	3000
10705B	15166B	1.000	25.40	0.063	1.60	1.260	32.00	0.354	9.00	1.114	28.30	3000
11148B	15165B	1.000	25.40	0.094	2.40	1.260	32.00	0.354	9.00	1.114	28.30	3000
11239B	—	1.250	31.50	0.031	0.80	1.504	38.20	0.276	7.00	1.240	31.50	2000
11059B	15168B	1.250	31.50	0.063	1.60	1.504	38.20	0.295	7.50	1.394	35.40	2000
11281B	15170B	1.260	32.00	0.122	3.10	1.504	38.20	0.354	9.00	1.394	35.40	2000
10877B	15171B	1.500	38.20	0.063	1.60	1.720	43.70	0.323	8.20	1.693	43.00	1500
10320B	15172B	2.031	51.50	0.063	1.60	2.264	57.50	0.488	12.40	2.071	52.60	500

Body Series TPE Hole Plugs

Specifications:

- Material: TPE
- Color: Black

Features:

- Each size covers a range of panel thicknesses
- Designed to fit standard metric holes
- Very resistant to oils, acids and alkalies
- Resistant to temperatures up to 203°F (95°C)

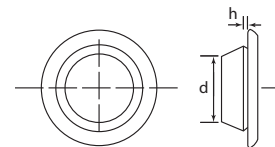

Item No.	Ø Hole d		Max Panel Thickness h		Bulk Pack Qty
	in	mm	in	mm	
BP-16230	0.394	10.00	0.032 - 0.078	0.8 - 2.0	5000
BP-16231	0.472	12.00	0.031 - 0.078	0.8 - 2.0	5000
BP-16232	0.551	14.00	0.031 - 0.078	0.8 - 2.0	5000
BP-16233	0.630	16.00	0.031 - 0.078	0.8 - 2.0	5000
BP-16234	0.709	18.00	0.031 - 0.078	0.8 - 2.0	2500

Item No.	Ø Hole d		Max Panel Thickness h		Bulk Pack Qty
	in	mm	in	mm	
16235B	0.787	20.00	0.031 - 0.078	0.8 - 2.0	2500
BP-16236	0.866	22.00	0.031 - 0.078	0.8 - 2.0	2500
16237B	0.984	25.00	0.031 - 0.078	0.8 - 2.0	3000
BP-16238	1.181	30.00	0.031 - 0.078	0.8 - 2.0	2000
10517B	1.772	45.00	0.031 - 0.078	0.8 - 2.0	1000

FIBER, WIRE & CABLE MANAGEMENT

Free Samples Available! Call Today.



FC PLUG Series
Circular Connector Plugs

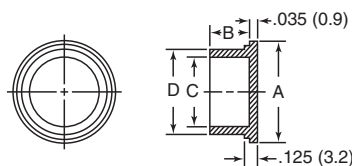

Specifications:

- Material: Low-Density Polyethylene
- Color: Yellow

Features:

- Designed for easy assembly and removal either with automated equipment or by hand
- Typically used to protect electrical connectors per Mil Spec 90376
- See page 36 if cap is needed

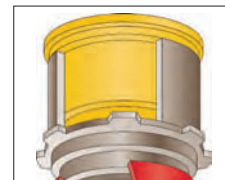

Item No.	MS90376 Dash No	To Plug Connector	A		B		C		D		Bulk Pack Qty
			in	mm	in	mm	in	mm	in	mm	
FC707A	MS90376-8Y	1/2 - 18	0.670	17.02	0.625	15.88	0.413	10.49	0.483	12.27	10000
FC709B	MS90376-10Y	5/8 - 24	0.750	19.05	0.625	15.88	0.530	13.46	0.595	15.11	8000
FC711B	MS90376-12Y	3/4 - 20	0.860	21.84	0.625	15.88	0.655	16.64	0.715	18.16	5500
FC713B	MS90376-14Y	7/8 - 20	1.031	26.19	0.625	15.88	0.785	19.94	0.845	21.46	4000
FC715B	MS90376-16Y	1 - 20	1.125	28.58	0.625	15.88	0.893	22.68	0.963	24.46	3000
FC717C	MS90376-18Y	1 - 1/8 - 18	1.250	31.75	0.625	15.88	1.028	26.11	1.088	27.64	3000
FC719A	MS90376-20Y	1 - 1/4 - 18	1.406	35.71	0.625	15.88	1.150	29.21	1.215	30.86	2000
FC721A	MS90376-22Y	1 - 3/8 - 18	1.500	38.10	0.625	15.88	1.270	32.26	1.340	34.04	1500
FC723A	MS90376-24Y	1 - 1/2 - 18	1.640	41.66	0.625	15.88	1.390	35.31	1.460	37.08	1400
FC725B	MS90376-25Y	1 - 5/8 - 18	1.810	45.97	0.625	15.88	1.540	39.12	1.580	40.13	1300
FC727C	MS90376-28Y	1 - 3/4 - 18	1.875	47.63	0.625	15.88	1.648	41.86	1.718	43.64	1200
FC731B	MS90376-32Y	2 - 18	2.125	53.98	0.625	15.88	1.890	48.01	1.970	50.04	900
FC735A	MS90376-36Y	2 - 1/4 - 16	2.340	59.44	0.625	15.88	2.140	54.36	2.210	56.13	800

H Series
Flanged Connector Plugs

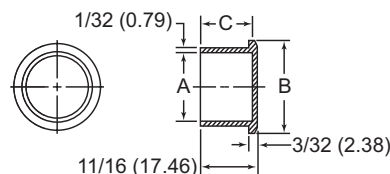

Specifications:

- Material: Low-Density Polyethylene
- Color: Yellow

Features:

- Designed for easy assembly and removal either with automated equipment or by hand
- Typically used to protect connectors with standard threads

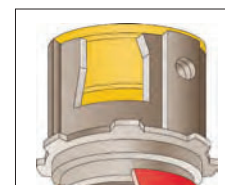

Item No.	To Plug Standard Thread	A		B		C		Bulk Pack Qty
		in	mm	in	mm	in	mm	
H1/2A	1/2" - 28	0.485	12.32	0.625	15.88	0.625	15.88	7000
H5/8A	5/8" - 24	0.601	15.27	0.750	19.05	0.625	15.88	5000
H3/4A	3/4" - 20	0.721	18.31	0.860	21.84	0.625	15.88	4000
H7/8A	7/8" - 20	0.850	21.59	1.000	25.40	0.625	15.88	2500
H1A	1" - 20	0.968	24.59	1.125	28.58	0.625	15.88	2000
H1-1/8A	1-1/8" - 18	1.097	27.86	1.250	31.75	0.625	15.88	1500
H1-1/4A	1-1/4" - 18	1.228	31.19	1.406	35.72	0.625	15.88	1500
H1-3/8A	1-3/8" - 18	1.345	34.16	1.500	38.10	0.625	15.88	2000
H1-1/2A	1-1/2" - 18	1.468	37.29	1.656	42.07	0.625	15.88	2000
H1-3/4A	1-3/4" - 18	1.732	43.99	1.906	48.42	0.625	15.88	1500

CABLE GLANDS, GROMMETS & CONDUIT

800 847 0486 | www.essentracomponents.com



PUSH-FIT PLUGS

TP/SP/FPL Series Packaging Tube Plugs

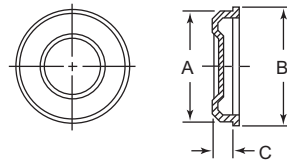

Specifications:

- Material: Low-Density Polyethylene
- Color: TP & SP: White, FPL: Black

Features:

- Designed for tube containers used in shipping, packaging and mail delivery
- Fits securely in the tube end
- SP Series has easy finger grip construction for convenient fast removal

Item No.	Tube ID in	A in	B in	C in	Bulk Pack Qty
TP1-1/2A	1.500	1.520	1.620	0.450	4000
SP1-1/2B	1.500	1.510	1.620	0.405	3500
TP2A	2.000	2.030	2.120	0.450	2300
SP2D	2.000	2.020	2.120	0.405	2100
TP2-1/8A	2.125	2.150	2.250	0.450	2000
TP2-1/4A	2.250	2.280	2.370	0.450	1800
TP2-1/2A	2.500	2.530	2.630	0.450	1400
SP2-1/2C	2.500	2.520	2.630	0.405	1500
TP2-3/4A	2.750	2.780	2.880	0.450	1250
TP3A	3.000	3.030	3.160	0.450	1000
SP3E	3.000	3.020	3.160	0.405	1000
TP3-1/4A	3.250	3.280	3.410	0.450	800
TP3-1/2A	3.500	3.530	3.660	0.450	700
SP3-1/2A	3.500	3.530	3.660	0.450	200
TP3-29/32A	3.900	3.940	4.060	0.450	600
TP4A	4.000	4.060	4.170	0.450	600
SP4A	4.000	4.030	4.160	0.450	500
TP4-3/4A	4.750	4.790	4.930	0.450	350
SP5A	5.000	5.040	5.170	0.450	300
SP6A	6.000	6.040	6.170	0.450	200
FPL6A	6.000	6.040	6.610	1.280	150
SP7A	7.000	7.040	7.170	0.450	200
FPL8A	8.000	8.025	8.610	1.290	100
FPL10A	10.000	10.150	10.730	1.350	50
FPL12A	12.000	12.140	12.700	1.350	30

HASSLE-FREE SERVICE



VISIT OUR WEBSITE
www.essentracomponents.com



SEND US AN EMAIL
sales@essentracomponents.com



GIVE US A CALL
800 847 0486



SEND US A FAX
866 561 6617





MPP Series Flexible Pull Plugs

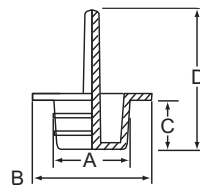

Type 1 – Center Pull

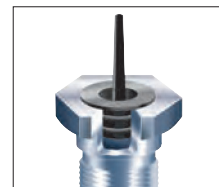

Specifications:

- Material: Thermoplastic Rubber
- Color: Black
- Temperature Range: -40°F to 275°F (-40°C to 135°C)

Features:

- The integral pull tab feature is designed for easy removal
- Protects threaded or non-threaded components
- Acid-resistant

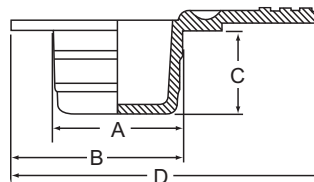

Type 2 – Side Pull



Item No.	To Fit		Type	A		B		C		D		Bulk Pack Qty
	Standard Thread	Metric Thread		in	mm	in	mm	in	mm	in	mm	
MPP3A	1/4"	M6	2	0.216	5.5	0.610	15.5	0.315	8.0	0.913	23.20	500
MPP4A	5/16"	M8	1	0.295	7.5	0.610	15.5	0.315	8.0	0.944	24.00	500
MPP5A	5/16"	M8	2	0.295	7.5	0.591	15.0	0.315	8.0	0.994	25.25	7000
MPP10A	3/8"	M10	1	0.374	9.5	0.689	17.5	0.315	8.0	1.181	30.00	8000
MPP15A	3/8"	M10	2	0.374	9.5	0.669	17.0	0.315	8.0	1.073	27.25	7000
MPP20A	1/2"	M12	1	0.453	11.5	0.768	19.5	0.394	10.0	1.181	30.00	7000
MPP25A	1/2"	M12	2	0.453	11.5	0.669	17.0	0.315	8.0	1.112	28.24	7000
MPP30A	9/16"	M14	1	0.501	12.8	0.846	21.5	0.394	10.0	1.181	30.00	6000
MPP35A	9/16"	M14	2	0.512	13.0	0.827	21.0	0.394	10.0	1.220	30.99	6000
MPP40A	5/8"	M16	1	0.598	15.2	0.925	23.5	0.394	10.0	1.260	32.00	4000
MPP45A	5/8"	M16	2	0.610	15.5	0.906	23.0	0.394	10.0	1.309	33.25	4000
MPP50A	11/16"	M18	2	0.669	17.0	1.024	26.0	0.394	10.0	1.398	35.51	4000
MPP55A	3/4"	M18	1	0.693	17.6	1.004	25.5	0.394	10.0	1.024	26.00	500
MPP60A	13/16"	M20	1	0.764	19.4	1.083	27.5	0.472	12.0	1.024	26.00	500
MPP65A	13/16"	M20	2	0.764	19.4	1.083	27.5	0.472	12.0	1.461	37.10	500
MPP70A	7/8"	M22	1	0.843	21.4	1.161	29.5	0.472	12.0	1.024	26.00	250
MPP75A	7/8"	M22	2	0.843	21.4	1.161	29.5	0.472	12.0	1.551	39.40	250
MPP80A	1"	M24	1	0.925	23.5	1.122	28.5	0.472	12.0	1.024	26.00	250
MPP85A	1"	M24	2	0.925	23.5	1.122	28.5	0.472	12.0	1.606	40.80	250

SFP Series Flangeless Tapered Plugs

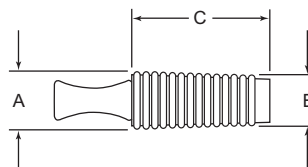

Specifications:

- Material: Thermoplastic Rubber
- Color: Black

Features:

- Protects threaded or unthreaded holes without masking the surrounding areas
- Ergonomically-friendly pull tab allows for easy installation and removal
- For high temperature version see page 76



Item No.	Plugs Threads		M	A		B		C		Bulk Pack Qty
	UN	M		in	mm	in	mm	in	mm	
10398B	#6 & #8	M3	0.196	5.0	0.118	3.0	0.59	15.0	10000	
18409B	#10 & #12	M4	0.236	6.0	0.157	4.0	1.00	25.4	6000	
18410B	1/4 & 5/16	M6	0.315	8.0	0.236	6.0	1.00	25.4	6000	
18411B	3/8	M8	0.394	10.0	0.315	8.0	1.00	25.4	4000	
18412B	7/16	M10	0.472	12.0	0.394	10.0	1.00	25.4	4000	
18414B	5/8	M14	0.630	16.0	0.551	14.0	1.00	25.4	4000	
18415B	11/16	M16	0.709	18.0	0.630	16.0	1.00	25.4	2000	



PUSH-FIT PLUGS FOR THREADS

I Series Push In Plugs for SAE/NPT Threads

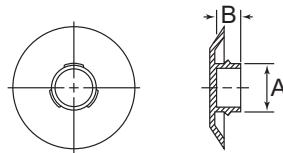

Specifications:

- Material: Low-Density Polyethylene
- Color: Yellow

Features:

- Provides all the advantages of a threaded plug with the ease of a push in style
- Snaps into place providing an attractive finish while keeping contaminants away from the fittings

Item No.	To Fit		A		B		Bulk Pack Qty
	SAE Thread	NPT Thread	in	mm	in	mm	
I1/4A	1/4	—	0.206	5.23	0.220	5.59	5000
I5/16A	5/16	—	0.262	6.65	0.235	5.97	5000
I3/8A	3/8	1/8	0.324	8.23	0.235	5.97	3000
PP3/8A	3/8	1/8	0.310	7.87	0.340	8.64	5000
I7/16A	7/16	—	0.380	9.65	0.270	6.86	3000
I1/2A	1/2	1/4	0.437	11.10	0.270	6.86	5000
I9/16A	9/16	—	0.495	12.57	0.290	7.37	5000
PP9/16A	9/16	—	0.480	12.19	0.360	9.14	5000
I5/8A	5/8	3/8	0.558	14.17	0.290	7.37	7500
I11/16A	11/16	—	0.610	15.49	0.290	7.37	7000
I3/4A	3/4	—	0.676	17.17	0.290	7.37	6000
I13/16A	13/16	1/2	0.732	18.59	0.290	7.37	5000

Item No.	To Fit		A		B		Bulk Pack Qty
	SAE Thread	NPT Thread	in	mm	in	mm	
I7/8A	7/8	—	0.798	20.27	0.295	7.49	4500
I1A	1	3/4	0.922	23.42	0.290	7.37	3500
I1-1/16A	1 - 1/16	—	0.972	24.69	0.290	7.37	3000
I1-3/16A	1 - 3/16	—	1.090	27.69	0.340	8.64	2000
I1-1/4A	1 - 1/4	—	1.160	29.46	0.340	8.64	2000
I1-5/16A	1 - 5/16	1	1.215	30.86	0.340	8.64	2000
I1-7/16A	1 - 7/16	—	1.360	34.54	0.460	11.68	1200
I1-1/2A	1 - 1/2	—	1.405	35.69	0.460	11.68	1100
I1-5/8A	1 - 5/8	—	1.525	38.74	0.460	11.68	1000
I1-3/4A	1 - 3/4	—	1.650	41.91	0.460	11.68	800
I1-7/8A	1 - 7/8	—	1.775	45.09	0.460	11.68	800

NPT Series Plugs for NPT Threads

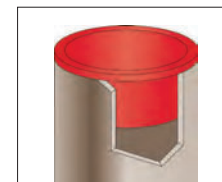
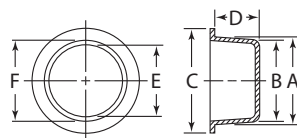

Specifications:

- Material: Low-Density Polyethylene
- Colors: See Table

Features:

- Designed specifically to be used to plug NPT tapered threaded fittings
- The tapered design allows the part to plug multiple inner diameters

To Assure Proper Fit:



Plug dimension "A" should be approx. 1% larger than the inner diameter of the part. Minimum of .020"

Item No.	Color	A		B		C		D		E		F		Bulk Pack Qty
		in	mm	in	mm	in	mm	in	mm	in	mm	in	mm	
NPT3/8A	Yellow	0.615	15.62	0.570	14.48	0.750	19.05	0.285	7.24	0.497	12.62	0.535	13.59	5000
NPT3/4A	Red	0.955	24.26	0.922	23.42	1.125	28.58	0.363	9.22	0.849	21.56	0.872	22.15	5500
NPT1-1/4A	Red	1.560	39.62	1.510	38.35	1.750	44.45	0.435	11.05	1.401	35.59	1.481	37.62	2000
NPT2A	Blue	2.275	57.79	2.225	56.52	2.437	61.90	0.495	12.57	2.092	53.14	2.194	55.73	2500
NPT2-1/2A	Black	2.725	69.22	2.680	68.07	2.875	73.03	0.480	12.19	2.512	63.80	2.628	66.75	600
NPT3A	Blue	3.325	84.46	3.285	83.44	3.500	88.90	0.470	11.94	3.154	80.11	3.220	81.79	400
NPT3-1/2A	Black	3.785	96.14	3.775	95.89	4.062	103.17	0.750	19.05	3.665	93.09	3.675	93.35	550
NPT4A	Blue	4.315	109.61	4.295	109.09	4.687	119.05	0.790	20.07	4.077	103.56	4.115	104.52	500
NPT5A	Blue	5.360	136.14	5.350	135.89	5.750	146.05	0.850	21.59	5.205	132.21	5.215	132.46	275
NPT6A	Blue	6.425	163.20	6.390	162.31	6.750	171.45	0.895	22.73	6.252	158.80	6.272	159.31	180

EN Series Plugs for NPT Threads

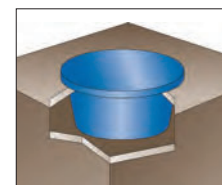
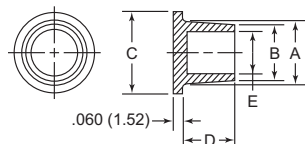

Specifications:

- Material: Low-Density Polyethylene
- Color: Blue

Features:

- Designed specifically to be used to plug NPT tapered threaded fittings
- The tapered design allows the part to plug multiple inner diameters

To Assure Proper Fit:



Plug dimension "A" should be approx. 1% larger than the inner diameter of the part. Minimum of .020"

Item No.	NPT Size I.D.	A		B		C		D		E		Bulk Pack Qty
		in	mm	in	mm	in	mm	in	mm	in	mm	
EN1/4A	1/4	0.485	12.32	0.420	10.67	0.609	15.48	0.281	7.14	0.355	9.02	5000
EN3/8A	3/8	0.640	16.26	0.550	13.97	0.766	19.45	0.500	12.70	0.500	12.70	6500
EN1/2A	1/2	0.785	19.94	0.690	17.53	0.906	23.02	0.500	12.70	0.625	15.88	4000
EN3/4A	3/4	0.975	24.77	0.870	22.10	1.094	27.78	0.625	15.88	0.812	20.63	2500
EN1A	1	1.200	30.48	1.090	27.69	1.344	34.13	0.656	16.67	1.301	26.19	1500

PUSH-FIT PLUGS FOR THREADS



Hydraulic Quick Release Dust Plugs

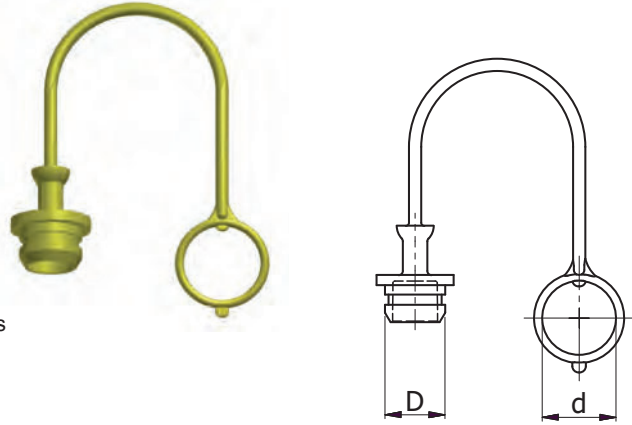

Specifications:

- Material: Thermoplastic Elastomer
- Color: See Table

Features:

- Suitable to plug ISO 7241-1 Series A and B Quick Couplings
- Designed to remain attached to the hose
- Excellent protection from dirt, moisture and corrosion
- Temperature Range: -40°F - 275°F (-40°C - 135°C)
- For cap version see page 38

Item No.					D		d		Bulk Pack Qty	
Red	Yellow	Green	Blue	Size	Series	mm	in	mm		in
499766	499776	499786	499796	1/4"	ISO A	12.7	0.500	19.6	0.772	150
499767	499777	499787	499797	3/8"	ISO A	18.3	0.720	25.0	0.984	150
499768	499778	499788	499798	1/2"	ISO A	23.6	0.929	31.0	1.220	150
499769	499779	499789	499799	3/4"	ISO A	29.2	1.150	36.0	1.417	150
499770	499780	499790	499800	1"	ISO A	36.5	1.437	48.0	1.890	150
499771	499781	499791	499801	1/4"	ISO B	15.5	0.610	22.2	0.874	150
499772	499782	499792	499802	3/8"	ISO B	20.0	0.787	28.0	1.102	150
499773	499783	499793	499803	1/2"	ISO B	25.7	1.012	35.0	1.378	150
499774	499784	499794	499804	3/4"	ISO B	32.7	1.287	42.0	1.654	150
499775	499785	499795	499805	1"	ISO B	40.5	1.594	51.0	2.008	150

SF Series

Snap Fit Plugs for Standard/JIC/Metric/BSP Threads



Specifications:

- Material: Low-Density Polyethylene
- Color: Red

Features:

- Once pushed into position, a single turn gives a tight fit
- Each plug covers a range of different thread sizes and styles
- The 12598A* has pull tab, not as illustrated

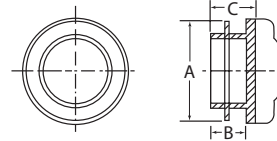

Item No.	To Fit Thread Sizes			A		B		C		Bulk Pack Qty
	Standard/JIC	Metric	BSP	in	mm	in	mm	in	mm	
10530A	7/16"	M10	1/8"	0.386	9.80	0.157	4.00	0.236	6.00	12000
12363A	1/2"	M12, M13, M14	1/4"	0.516	13.10	0.197	5.00	0.276	7.00	10000
12364A	5/8"	M16	3/8"	0.650	16.50	0.197	5.00	0.276	7.00	10000
10314B	3/4"	M18	1/2"	0.720	18.30	0.276	7.00	0.354	9.00	7000
12365A	—	M20	1/2"	0.839	21.30	0.276	7.00	0.354	9.00	5000
12366A	7/8"	M22	5/8"	0.882	22.40	0.276	7.00	0.354	9.00	5000
12621A	—	M24	—	0.925	23.50	0.276	7.00	0.354	9.00	3000
12367A	1 1/16"	M25, M26	3/4"	1.004	25.50	0.276	7.00	0.354	9.00	2000
12368A	1 - 1/8"	M28	7/8"	1.098	27.90	0.276	7.00	0.354	9.00	3000
12369A	1 - 5/16"	M32	1"	1.260	32.00	0.276	7.00	0.354	9.00	2500
12622A	1 - 1/2", 1 - 3/8"	M36	1-1/8"	1.406	35.70	0.276	7.00	0.354	9.00	2000
12598A*	1 - 5/8"	M40, M42	1-1/4"	1.634	41.50	0.276	7.00	0.354	9.00	2000



IT'S SIMPLE:

JUST SAMPLE!

Over 5,000 caps and plugs in stock. Order your FREE samples today.

Our extensive range of caps and plugs provides thousands of solutions for protecting vital components during shipment, storage and finishing processes. Shop our complete line at www.essentracomponents.com





PUSH-FIT PLUGS FOR THREADS

EZP Series

Quick Fit Easy Pull Plugs for Unified Standard/Metric Threads



Specifications:

- Material: Low-Density Polyethylene
- Color: Red

Features:

- Patented Quick Fit design easily locks the plug into place with a simple push
- Strong and flexible pull-tab for quick removal
- Seven sizes in two styles protect more than 25 popular threaded sizes

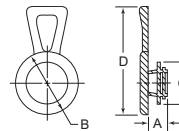

Type 1 - Lateral Pull

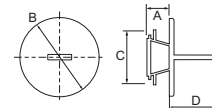

Type 2 - Central Pull

Item No.	To Fit		Type	A		B		C		D		Bulk Pack Qty
	Standard Thread	Metric Thread		in	mm	in	mm	in	mm	in	mm	
EZP1010A	5/16", 3/8"	M8	1	0.300	7.62	0.515	13.08	0.375	9.53	1.195	30.35	10000
EZP1020C	7/16"	M10, M12	1	0.300	7.62	0.748	19.05	0.520	13.20	1.340	34.04	5000
EZP2020A	7/16"	M10, M12	2	0.354	9.00	0.748	19.00	0.519	13.20	0.834	21.20	500
EZP1030A	1/2", 5/8", 9/16"	M14, M16	1	0.275	7.00	0.893	22.70	0.649	16.50	1.574	40.00	5000
EZP2030A	1/2", 5/8", 9/16"	M14, M16	2	0.275	7.00	0.893	22.70	0.649	16.50	0.834	21.20	500
EZP1040A	3/4"	M18, M20	1	0.314	8.00	1.181	30.00	0.767	19.50	1.850	47.00	4000
EZP2040A	3/4"	M18, M20	2	0.314	8.00	1.181	30.00	0.767	19.50	0.842	21.40	250
EZP1050A	7/8"	M22, M24	1	0.374	9.50	1.350	34.30	0.937	23.80	2.023	51.40	3000
EZP2050A	7/8"	M22, M24	2	0.374	9.50	1.350	34.30	0.937	23.80	0.842	21.40	250
EZP1060A	1 - 1/16", 1 - 1/8"	M26, M28	1	0.374	9.50	1.574	40.00	1.086	27.60	2.244	57.00	2000
EZP2060A	1 - 1/16", 1 - 1/8"	M26, M28	2	0.374	9.50	1.574	40.00	1.086	27.60	0.846	21.50	100
EZP1070A	1 - 1/4", 1 - 3/8"	M30, M36	1	0.393	10.00	1.771	45.00	1.358	34.50	2.440	62.00	1500

QFP Series

Quick Fit Plugs for UNF/JIC/Metric Threads



Specifications:

- Material: Low-Density Polyethylene
- Color: Red

Features:

- Fewer thread forms allow for quick application

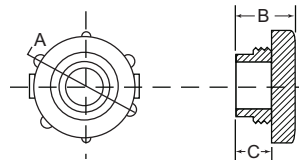

UNF/JIC

Item No.	To Fit UNF/JIC Thread Size	A		B		C		Bulk Pack Qty
		in	mm	in	mm	in	mm	
QFP005A	7/16" x 20	0.728	18.50	0.354	9.00	0.232	5.90	5000
QFP010A	1/2" x 20	0.811	20.60	0.358	9.10	0.232	5.90	5000
QFP015A	9/16" x 18	0.843	21.40	0.354	9.00	0.232	5.90	5000
QFP020A	3/4" x 16	1.051	26.70	0.366	9.30	0.232	5.90	3000
QFP025A	7/8" x 14	1.173	29.80	0.362	9.20	0.244	6.20	2500
QFP030A	1 - 1/16" x 12	1.335	33.90	0.354	9.00	0.232	5.90	2000
QFP035A	1 - 5/16" x 12	1.587	40.30	0.37	9.40	0.236	6.00	1500

Metric

Item No.	To Fit Metric Thread Size	A		B		C		Bulk Pack Qty
		in	mm	in	mm	in	mm	
QFP105A	M14 x 1.5	0.846	21.50	0.492	12.50	0.315	8.00	5000
QFP110A	M16 x 1.5	0.929	23.60	0.492	12.50	0.315	8.00	3000
QFP115A	M20 x 1.5	1.157	29.38	0.512	13.00	0.315	8.00	3000
QFP120A	M30 x 2.0	1.556	34.52	0.575	14.60	0.386	9.80	1500
QFP125A	M36 x 2.0	1.795	45.60	0.649	16.48	0.413	10.50	1000
QFP130A	M42 x 2.0	2.133	54.17	0.854	21.69	0.61	15.50	700
QFP135A	M45 x 2.0	2.232	56.69	0.728	18.50	0.500	12.70	700
QFP140A	M52 x 2.0	2.594	65.90	0.839	21.30	0.606	15.40	500

UN Series

Quick Fit Plugs for Standard/JIC/Metric/BSP Threads



Specifications:

- Material: Low-Density Polyethylene
- Color: Red

Features:

- This uniquely-designed range of plugs have sets of blades which will lock tight when pushed into a threaded hole and twisted
- Each plug covers a range of different thread sizes and styles
- Easily removes by simply unscrewing the plug from the thread

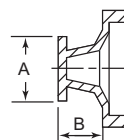

Item No.	To Fit Thread Sizes				A		B		Bulk Pack Qty
	NPT	Standard/JIC	Metric	BSP	in	mm	in	mm	
UN9995A	—	—	—	—	0.420	10.66	0.233	5.91	10000
UN9996A	1/8"	7/16"	M10	1/8"	0.438	11.12	0.240	6.09	10000
UN9997A	1/4"	9/16"	M14	—	0.575	14.60	0.285	7.23	10000
UN9998A	—	1/2"	M12	1/4"	0.485	12.31	0.325	8.25	10000
UN9763A	—	3/4"	M16 - 20	3/8"	0.780	19.81	0.375	9.52	5000
UN9764A	—	1"	M20 - 24	1/2" - 5/8"	0.990	25.14	0.445	11.30	2500
UN9774A	3/4"	1 - 3/16"	M30	3/4" - 7/8"	1.240	31.49	0.435	11.04	2000
UN9765A	—	1-7/16"	M33 - 36	1"	1.475	37.46	0.445	11.30	1000



Fluid Absorption Plugs

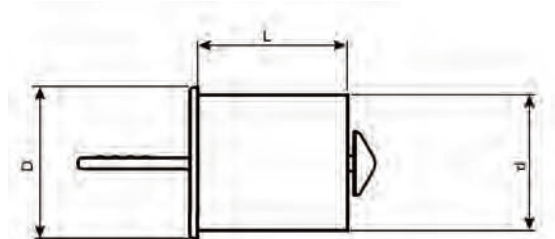

Specifications:

- Material: Polypropylene, Bi-Component Fiber
- Color: Yellow

Features:

- Control excess fluid residue from leaking
- Unique design allows quick, easy installation and removal to save time and cost
- Safer, easier and cleaner than a conventional plug; eliminates residue in the thread/hole

Item No.	To Fit Thread Sizes			D mm	d mm	l mm	Absorption** ml	Bulk Pack Qty
	Metric	BSP	UNF					
1342611	M10 x 1.5	1/8" x 28	3/8" x 24	10.7	8.5	15	0.54	1000
1342613	M12 x 1.5	—	—	12.5	10.5	15	0.86	1000
1342615	—	1/4" x 19	—	13.6	11.5	15	1.05	1000
1349120	M14 x 1.5	—	9/16" x 18	14.5	12.5	20	1.36	1000
1342618	M14 x 1.5	—	9/16" x 18	14.5	12.5	25	1.70	1000
1342619	M16 x 1.5	—	5/8" x 18	16.5	14.5	15	1.48	1000
1342622	M18 x 1.5	—	—	19.0	17.0	25	3.57	1000
1342624	—	3/8" x 19	—	17.2	15.0	25	2.75	1000
1349119	—	-	—	20.0	18.0	20	3.25	1000
1342625	M20 x 1.5	1/2" x 14	—	20.8	18.5	25	4.32	1000
1342626	M22 x 1.5	5/8" x 14	—	22.8	21.0	25	5.60	1000
1342627	—	3/4" x 14	1-1/16" x 12	26.5	24.6	25	8.04	1000
1342628	—	1" x 11	—	32.5	30.5	35	17.68	1000

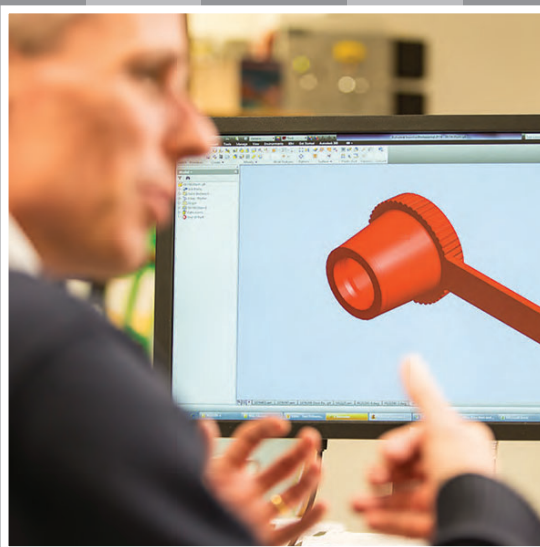

CUSTOM SOLUTIONS AVAILABLE

Looking for a different color, material, size... or something else? We can create it!

Expert In-House Engineering Design Team

3D CAD & 3D Printing Technology Available

Rapid Prototyping to Bring Your Ideas to Life



CAPS, PLUGS & NETTING
THREADED PLUGS

BL Series
UNF Standard Threaded Plugs (O-Ring optional)



Specifications:

- Material: Polypropylene
- Color: Yellow

Features:

- Can be applied or removed by hand, hex wrench or screwdriver
- Optional O-Ring gives this part a water tight seal for superior leakage protection

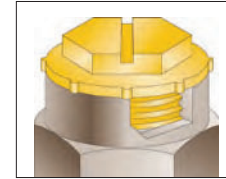
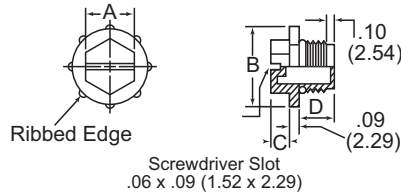

See pages 64 and 65 for Application Wizards

Item No.	Item No. w/ O-Ring	To Plug Standard Thread Size	A		B		C		D		Bulk Pack Qty
			in	mm	in	mm	in	mm	in	mm	
BL3A	BL3L	7/16" - 20	0.430	10.92	0.620	15.75	0.180	4.57	0.390	9.91	5000
*BL4A	*BL4B	1/2" - 13	0.500	12.70	0.687	17.46	0.281	7.14	0.410	10.41	3000
BL5A	BL5K	9/16" - 18	0.500	12.70	0.750	19.05	0.180	4.57	0.420	10.67	3000
BL7A	BL7J	3/4" - 16	0.680	17.27	0.940	23.88	0.190	4.83	0.520	13.21	1500
BL8A	BL8H	7/8" - 14	0.750	19.05	1.060	26.92	0.240	6.10	0.560	14.22	2100
BL10A	BL10I	1-1/16" - 12	0.870	22.10	1.310	33.27	0.250	6.35	0.660	16.76	600
BL11A	BL11D	1-3/16" - 12	1.000	25.40	1.500	38.10	0.300	7.62	0.700	17.78	425
BL12A	BL12H	1-5/16" - 12	1.070	27.18	1.610	40.89	0.290	7.37	0.700	17.78	700
BL13A	BL13D	1-5/8" - 12	1.125	28.58	1.880	42.75	0.300	7.62	0.770	19.56	500
BL14A	BL14C	1-7/8" - 12	1.500	38.10	2.125	53.98	0.300	7.62	0.750	19.05	700

*BL4A and BL4B are black and UNC Threaded

BL Nylon Series
UNF Standard Threaded Nylon Plugs (O-Ring optional)



Specifications:

- Material: Nylon
- Color: Natural

Features:

- Can be applied or removed by hand, hex wrench or screwdriver
- Optional O-Ring gives this part a water tight seal for superior leakage protection
- Recommended when strength and abrasion resistance are desired
- The nylon material absorbs paint, keeping paint flakes to a minimum
- Nylon is able to withstand higher temperatures than Polypropylene
- Temperature Range: -40°F - 230°F (-40°C - 110°C)

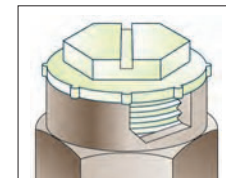
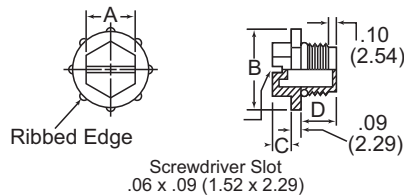

Item No.	Item No. w/ O-Ring	To Plug Standard Thread Size	A		B		C		D		Bulk Pack Qty
			in	mm	in	mm	in	mm	in	mm	
BL3D	BL3I	7/16" - 20	0.430	10.92	0.620	15.75	0.180	4.57	0.390	9.91	10000
BL5C	BL5N	9/16" - 18	0.500	12.70	0.750	19.05	0.180	4.57	0.420	10.67	6000
BL7C	BL7G	3/4" - 16	0.680	17.27	0.940	23.88	0.190	4.83	0.520	13.21	3000
BL8B	BL8P	7/8" - 14	0.750	19.05	1.060	26.92	0.240	6.10	0.560	14.22	2100
BL10C	BL10M	1-1/16" - 12	0.870	22.10	1.310	33.27	0.250	6.35	0.660	16.76	1200
BL11E	BL11C	1-3/16" - 12	1.000	25.40	1.500	38.10	0.300	7.62	0.700	17.78	425
BL12B	BL12M	1-5/16" - 12	1.070	27.18	1.610	40.89	0.290	7.37	0.700	17.78	700
BL13G	BL13C	1-5/8" - 12	1.125	28.58	1.880	42.75	0.300	7.62	0.770	19.56	1000



HOSE PROTECTION

Wrap it. Cover it. Shield it. Secure it.

SPIRALGUARD



B Series
UNF Standard Threaded Plugs

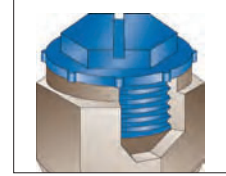
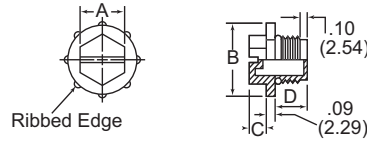

Specifications:

- Material: High-Density Polyethylene
- Color: Blue

Features:

- Threaded plug with a serrated grip (used for a variety of applications)
- Can be applied or removed by hand, hex wrench or screwdriver

Item No.	To Plug Standard Thread Size	A		B		C		D		Bulk Pack Qty
		in	mm	in	mm	in	mm	in	mm	
B3A	7/16" - 20	0.430	10.92	0.620	15.75	0.180	4.57	0.300	7.62	11000
B4A	1/2" - 20	0.500	12.70	0.680	12.27	0.180	4.57	0.360	9.14	7500
B5A	9/16" - 18	0.500	12.70	0.750	19.05	0.180	4.57	0.382	9.70	6000
B6A	5/8" - 18	0.560	14.22	0.810	20.57	0.180	4.57	0.350	8.89	5000
B7A	3/4" - 16	0.680	17.27	0.940	23.88	0.190	4.83	0.440	11.18	3500

Item No.	To Plug Standard Thread Size	A		B		C		D		Bulk Pack Qty
		in	mm	in	mm	in	mm	in	mm	
B8A	7/8" - 14	0.750	19.05	1.060	26.92	0.240	6.10	0.500	12.70	2100
B9A	1" - 14	0.750	19.05	1.180	29.97	0.250	6.35	0.430	10.92	2000
B10A	1-1/8" - 14	0.870	22.10	1.310	33.27	0.250	6.35	0.645	16.38	1200
B11A	1-1/16" - 12	0.870	22.10	1.310	33.27	0.250	6.35	0.620	15.75	1300

TPUNF Series
UNF/JIC Knurled Head Threaded Plugs

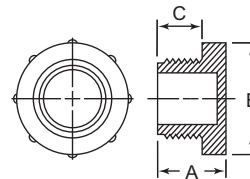

Specifications:

- Material: Low-Density Polyethylene
- Color: Red

Features:

- Knurled head for easy hand installation or removal
- Secure fit for excellent protection against dirt, moisture and corrosion

Item No.	To Plug UNF/JIC Thread Size	A		B		C		Bulk Pack Qty
		in	mm	in	mm	in	mm	
10498A	5/16" - 18	0.472	12.00	0.571	14.50	0.291	7.40	5000
10709A	5/16" - 24	0.484	12.30	0.583	14.80	0.291	7.40	5000
10692A	3/8 - 24	0.551	14.00	0.539	13.70	0.374	9.50	5000
10763A	7/16" - 20	0.634	16.10	0.685	17.40	0.433	11.00	5000
12031A	7/16" - 24	0.476	12.10	0.701	17.80	0.28	7.10	5000
10696A	1/2" - 20	0.602	15.30	0.728	18.50	0.413	10.50	5000
10668A	9/16" - 18	0.606	15.40	0.890	22.60	0.421	10.70	5000
12033A	9/16" - 24	0.535	13.60	0.744	18.90	0.354	9.00	5000
10940A	5/8" - 18	0.583	14.80	0.827	21.00	0.394	10.00	5000
12965A	5/8" - 24	0.583	14.80	0.815	20.70	0.394	10.00	5000
12786A	11/16" - 16	0.713	18.10	1.008	25.60	0.531	13.50	3000

Item No.	To Plug UNF/JIC Thread Size	A		B		C		Bulk Pack Qty
		in	mm	in	mm	in	mm	
10575A	3/4" - 16	0.736	18.70	1.063	27.00	0.543	13.80	3000
12827A	13/16" - 16	0.713	18.10	1.051	26.70	0.531	13.50	2500
10326A	7/8" - 14	0.728	18.50	1.134	28.80	0.535	13.60	2500
12785A	1" - 14	0.701	17.80	1.26	32.00	0.52	13.20	2000
10460A	1-1/16" - 12	0.724	18.40	1.315	33.40	0.543	13.80	2000
12359A	1-1/16" - 14	0.720	18.30	1.311	33.30	0.539	13.70	2000
11506A	1-3/16" - 12	0.72	18.30	1.449	36.80	0.531	13.50	1500
10671A	1-5/16" - 12	0.642	16.30	1.547	39.30	0.433	11.00	1500
11752A	1-5/8" - 12	0.681	17.30	1.992	50.60	0.508	12.90	800
11755A	1-7/8" - 12	0.886	22.50	2.299	58.40	0.657	16.70	400
12040A	2-1/2" - 12	0.811	20.60	2.898	73.60	0.591	15.00	300

BLM Series
UNF Standard Threaded Molded O-Ring Plugs

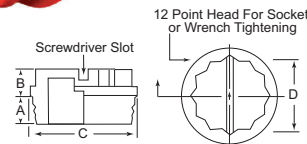

Specifications:

- Material: High-Density Polyethylene
- Color: Red

Features:

- Often used on flat-faced hydraulic fittings
- Integral O-Ring type bead prevents oil leakage or entrance of contaminants
- The flange lip compresses against the surface to keep contaminants out
- Can be applied or removed by hand, wrench, socket or screwdriver

Item No.	To Plug Standard Thread Size	A		B		C		D		Bulk Pack Qty
		in	mm	in	mm	in	mm	in	mm	
BLM3B	7/16" - 20	0.344	8.74	0.281	7.14	0.660	16.76	3/8	8000	
BLM3-24B	7/16" - 24	0.344	8.74	0.281	7.14	0.660	16.76	3/8	8000	
BLM4B	1/2" - 20	0.344	8.74	0.313	7.95	0.730	18.54	7/16	6000	
BLM5B	9/16" - 18	0.350	8.89	0.323	8.20	0.800	20.32	1/2	6000	
BLM6B	5/8" - 18	0.375	9.53	0.313	7.95	0.820	20.83	9/16	5000	
BLM7B	3/4" - 16	0.406	10.31	0.406	10.31	1.020	25.91	11/16	3000	
BLM8B	7/8" - 14	0.469	11.91	0.313	7.95	1.160	29.46	13/16	2000	

Item No.	To Plug Standard Thread Size	A		B		C		D		Bulk Pack Qty
		in	mm	in	mm	in	mm	in	mm	
BLM9B	1" - 14	0.500	12.70	0.313	7.95	1.250	31.75	7/8	1500	
BLM10B	1-1/16"-12	0.594	15.09	0.313	7.95	1.450	36.83	1	1000	
BLM11B	1-3/16"-12	0.594	15.09	0.344	8.74	1.500	38.10	1-1/8	1000	
BLM12B	1-5/16"-12	0.594	15.09	0.344	8.74	1.740	44.20	1-1/4	1000	
BLM13B	1-5/8"-12	0.594	15.09	0.344	8.74	2.156	54.76	1-1/2	700	
BLM14B	1-7/8"-12	0.594	15.09	0.344	8.74	2.188	55.58	1-5/8	700	



CAPS, PLUGS & NETTING
THREADED PLUGS

TE Series
Threaded Plugs for 37° JIC Flared Fittings



Specifications:

- Material: Low-Density Polyethylene
- Color: Red

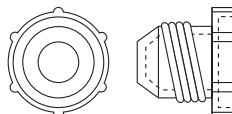

Features:

- Designed with a knurled head for easy finger installation
- Used to seal light pressure requirements on 37° JIC flared fittings
- Functionally Equivalent to Spec: NAS-833, NAS-815 (MIL-C5501/1, MIL-C52078)

Item No.	Tubing Size in	To Plug JIC Thread Size	JIC Fitting Size	Bulk Pack Qty
TE1000A	1/8	5/16" - 24	2	5000
TE1005A	3/16	3/8" - 24	3	5000
TE1010A	1/4	7/16" - 20	4	5000
TE1015A	5/16	1/2" - 20	5	5000
TE1020A	3/8	9/16" - 18	6	5000
TE1025A	3/8	5/8" - 18	—	5000
TE1030A	1/2	3/4" - 16	8	2500
TE1035A	5/8	7/8" - 14	10	2500
TE1040A	3/4	1 - 1/16" - 12	12	2500

Item No.	Tubing Size in	To Plug JIC Thread Size	JIC Fitting Size	Bulk Pack Qty
TE1045A	3/4	1 - 1/16" - 14	—	1000
TE1050A	7/8	1 - 3/16" - 12	14	2500
TE1055A	1	1 - 5/16" - 12	16	1000
TE1060A	—	1 - 1/2 - 12	—	1000
TE1065A	1 - 1/4	1 - 5/8 - 12	20	1000
TE1070A	—	1 - 3/4 - 12	—	1000
TE1075A	1 - 1/2	1 - 7/8 - 12	24	500
TE1080A	1 - 3/4	2 - 1/4 - 12	28	500
TE1085A	2	2 - 1/2 - 12	32	500

TF Series
Threaded Plugs for Flat Faced O-Ring Hydraulic Fittings



Specifications:

- Material: Polyethylene
- Color: Red

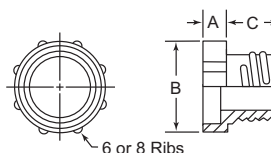

Features:

- Head designed with six or eight ribs for simple hand or mechanical installation
- Used to protect flat-faced O-Ring hydraulic fittings

Item No.	Tubing Size in	To Plug Thread Size	A		B		C		Bulk Pack Qty
			in	mm	in	mm	in	mm	
TF10A	1/4	9/16" - 18	0.250	6.40	0.690	17.50	0.380	9.50	5000
TF20B	3/8	11/16" - 16	0.250	6.40	0.870	22.10	0.410	10.4	5000
TF30B	1/2	13/16" - 16	0.250	6.40	0.940	23.90	0.470	11.9	5000
TF40B	5/8	1" - 14	0.250	6.40	1.160	29.50	0.570	14.5	2500
TF50B	3/4	1 - 3/16" - 12	0.250	6.40	1.320	33.50	0.610	15.5	2500
TF60B	1	1 - 7/16" - 12	0.250	6.40	1.630	41.40	0.690	17.5	1000
TF80B	1-1/4	1 - 11/16" - 12	0.250	6.40	1.880	47.75	0.890	22.6	1000

FP Series
NS & NF Class 1-2-3 Threaded Plugs (O-Ring Optional)



Specifications:

- Material: Polypropylene
- Color: Red

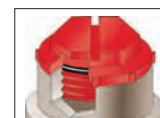
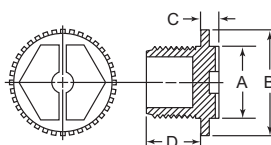

Features:

- Can be applied or removed by hand, hex wrench or screwdriver
- Will fit NS and NF Class 1-2-3 standard threads
- Optional O-Ring gives this part a watertight seal for superior leakage protection

Item No.	Item No. w/ O-Ring	To Plug Standard Thread Size	A		B		C		D		Bulk Pack Qty
			in	mm	in	mm	in	mm	in	mm	
FP104A	FP104B	7/16" - 20	0.438	11.11	0.625	15.88	0.188	4.76	0.300	7.62	9500
FP108A	FP108B	9/16" - 18	0.500	12.70	0.781	19.84	0.188	4.76	0.350	8.89	5000
FP110A	FP110B	5/8" - 18	0.563	14.29	0.813	20.64	0.188	4.76	0.350	8.89	4500
FP115A	FP115B	3/4" - 16	0.688	17.46	0.938	23.81	0.188	4.76	0.440	11.18	2700
FP120A	FP120B	7/8" - 14	0.750	19.05	1.063	26.99	0.250	6.35	0.500	12.70	1800
FP122A	FP122B	1" - 14	0.750	19.05	1.188	30.16	0.250	6.35	0.470	11.94	1500



TMO Series
Threaded Plugs for SAE O-Ring Ports

Specifications:

- Material: High-Density Polyethylene
- Color: Red

Features:

- Designed with an easy to grip head for ease of hand installation
- Threads meet UN and UNS specifications
- Integral O-Ring type bead prevents leakage and entrance of contaminants
- Protects threaded components from dust, moisture and damage during production, storage and shipment

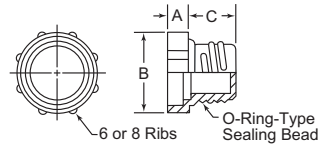

Item No.	To Plug Standard Thread Size	A		B		C		Bulk Pack Qty
		in	mm	in	mm	in	mm	
TMO104A	7/16"-20	0.320	8.13	0.650	16.51	0.380	9.65	5500
TMO105A	1/2"-20	0.320	8.13	0.720	18.29	0.380	9.65	7500
TMO106A	9/16"-18	0.360	9.14	0.780	19.81	0.380	9.65	6000
TMO108A	3/4"-16	0.400	10.16	0.980	24.89	0.380	9.65	3500

Item No.	To Plug Standard Thread Size	A		B		C		Bulk Pack Qty
		in	mm	in	mm	in	mm	
TMO110A	7/8"-14	0.450	11.43	1.110	28.19	0.380	9.65	2100
TMO112A	1-1/16"-12	0.620	15.75	1.310	33.27	0.380	9.65	1200
TMO116A	1-5/16"-12	0.620	15.75	1.560	39.62	0.380	9.65	700
TMO120A	1-5/8"-12	0.620	15.75	1.880	47.75	0.380	9.65	700

BLWF Series
UNF Standard Threaded Wide Flange Plugs

Specifications:

- Material: Plug – Nylon, Gasket – Nitrile
- Color: Plug – Yellow, Gasket – Black

Features:

- The wide flange design keeps any paint flakes away from the hole when removed
- The nylon material absorbs paint keeping paint flakes to a minimum
- The nitrile gasket seals the plug to the mating surface for a watertight seal
- Can be applied or removed by hand, screwdriver or with a torque wrench
- Temperature Range: -40°F - 230°F (-40°C - 110°C)

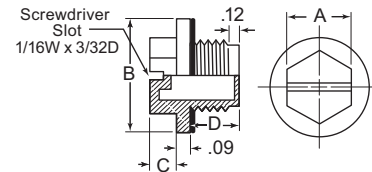

Item No.	To Plug UNF Thread Size	A		B		C		D		Bulk Pack Qty
		in	mm	in	mm	in	mm	in	mm	
BLWF100A	7/16" - 20	0.500	12.70	0.775	19.69	0.180	4.57	0.390	9.91	5000
BLWF105A	1/2" - 20	0.500	12.70	0.853	21.67	0.180	4.57	0.405	10.29	5000
BLWF110A	9/16" - 18	0.500	12.70	0.917	23.29	0.180	4.57	0.420	10.67	2500
BLWF115A	3/4" - 16	0.750	19.05	1.130	28.70	0.190	4.83	0.520	13.21	2500
BLWF120A	7/8" - 14	0.750	19.05	1.284	32.61	0.240	6.10	0.560	14.22	2500
BLWF125A	1 - 1/16" - 12	1.000	25.40	1.577	40.06	0.250	6.35	0.660	16.76	1000
BLWF130A	1 - 3/16" - 12	1.000	25.40	1.722	43.74	0.300	7.62	0.700	17.78	1000
BLWF135A	1 - 5/16" - 12	1.000	25.40	1.867	47.42	0.290	7.37	0.700	17.78	1000
BLWF140A	1 - 5/8" - 12	1.125	28.57	2.217	56.31	0.300	7.62	0.770	19.56	500
BLWF145A	1 - 7/8" - 12	1.500	38.10	2.507	63.68	0.300	7.62	0.750	19.05	500

TSSP Series
Sealing Threaded Plugs For UNF Threads

Specifications:

- Material: Nylon
- Color: Yellow

Features:

- The double sealing ring design on the underside of the flange provides a positive seal
- Design includes five complete threads for a secure fit
- Can be manually applied or removed with a screwdriver, spanner, socket or allen key or with power tools
- Head designed not to trap liquid
- The nylon material absorbs paint, keeping paint flakes to a minimum
- Temperature Range: -40°F - 320°F (-40°C - 160°C)
- See page 60 for Metric and BSP Threads

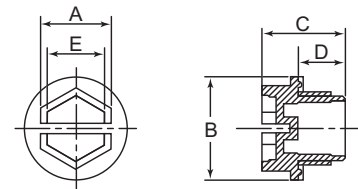

See pages 64 and 65 for Application Wizards

Item No.	To Plug UNF Thread Size	A		B		C		D		E		Bulk Pack Qty
		in	mm	in	mm	in	mm	in	mm	in	mm	
TSSP3/8-24A	3/8" - 24	0.354	9.0	0.630	16.0	0.689	17.5	0.394	10.0	0.236	6.0	5000
TSSP7/16-20A	7/16" - 20	0.394	10.0	0.669	17.0	0.689	17.5	0.394	10.0	0.276	7.0	5000
TSSP1/2-20A	1/2" - 20	0.512	13.0	0.748	19.0	0.689	17.5	0.394	10.0	0.394	10.0	3000
TSSP9/16-18A	9/16" - 18	0.512	13.0	0.807	20.5	0.689	17.5	0.394	10.0	0.394	10.0	3000
TSSP5/8-18A	5/8" - 18	0.591	15.0	0.866	22.0	0.689	17.5	0.394	10.0	0.472	12.0	3000
TSSP3/4-16A	3/4" - 16	0.748	19.0	1.024	26.0	0.689	17.5	0.394	10.0	0.630	16.0	3000
TSSP7/8-14A	7/8" - 14	0.827	21.0	1.124	28.5	0.768	19.5	0.472	12.0	0.709	18.0	3000
TSSP1-14A	1" - 14	0.945	24.0	1.240	31.5	0.768	19.5	0.472	12.0	0.827	21.0	1000
TSSP1-1/16-12A	1 - 1/16" - 12	0.945	24.0	1.299	33.0	0.768	19.5	0.472	12.0	0.827	21.0	1000
TSSP1-3/16-12A	1 - 3/16" - 12	1.181	30.0	1.437	36.5	0.886	22.5	0.591	15.0	1.063	27.0	1000
TSSP1-5/16-12A	1 - 5/16" - 12	1.181	30.0	1.575	40.0	0.886	22.5	0.591	15.0	1.063	27.0	1000
TSSP1-5/8-12A	1 - 5/8" - 12	1.417	36.0	1.870	47.5	0.886	22.5	0.591	15.0	1.299	33.0	500
TSSP1-7/8-12A	1 - 7/8" - 12	1.417	36.0	2.126	54.0	0.886	22.5	0.591	15.0	1.299	33.0	500



R Series
NPT Threaded Square-Headed Plugs



Specifications:

- Material: High-Density Polyethylene or Glass-Filled Nylon - See Table
- Color: See Table

Features:

- Square head design allows the user to install or remove these by hand or with a wrench
- Used to protect NPT threads against contaminants and moisture
- Nylon is recommended when strength and abrasion resistance are desired
- The nylon material absorbs paint, keeping paint flakes to a minimum
- Nylon is able to withstand higher temperatures than HDPE
- Temperature Range: -40°F - 320°F (-40°C - 160°C)

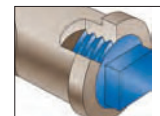
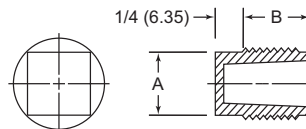

Item No.		To Plug NPT Thread Size	A		B		Bulk Pack Qty
Blue HDPE	Natural GFN		in	mm	in	mm	
R1/8A	R1/8C	1/8" - 27	9/32	7.14	0.375	9.53	8500
R1/4A	R1/4C	1/4" - 18	11/32	8.73	0.437	11.11	9000
R3/8A	R3/8B	3/8" - 18	7/16	11.11	0.500	12.70	5000
R1/2A	R1/2D	1/2" - 14	9/16	14.28	0.562	14.29	3000
R3/4A	R3/4B	3/4" - 14	11/16	17.46	0.625	15.88	1900

Item No.		To Plug NPT Thread Size	A		B		Bulk Pack Qty
Blue HDPE	Natural GFN		in	mm	in	mm	
R1A	R1B	1"-11 - 1/2	3/4	19.05	0.625	15.88	1000
R1-1/4A	R1-1/4C	1-1/4" - 11 - 1/2	15/16	23.81	0.625	15.88	500
R1-1/2A	R1-1/2C	1-1/2" - 11 - 1/2	1 - 1/8	28.57	0.625	15.88	500
R2A	R2C	2"-11 - 1/2	1 - 1/4	31.75	0.625	15.88	500

PFP Series
NPT Threaded Plugs (O-Ring Optional)



Specifications:

- Material: High-Density Polyethylene
- Color: Black

Features:

- Unique head design allows the user to apply or remove this plug by hand or with a 12 point socket head, screwdriver or wrench
- Used to protect NPT threaded ports
- Optional O-Ring gives this part a watertight seal for superior leakage protection

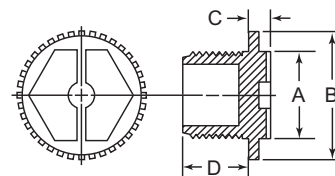

Item No.	Item No. w/ O-Ring	To Plug NPT Thread Size	A		B		C		D		Bulk Pack Qty
			in	mm	in	mm	in	mm	in	mm	
PFP1/8A	PFP1/8B	1/8"	0.348	8.84	0.560	14.22	0.250	6.35	0.250	6.35	5000
PFP1/4A	PFP1/4B	1/4"	0.489	12.42	0.740	18.80	0.310	7.87	0.310	7.87	5000
PFP3/8A	PFP3/8B	3/8"	0.562	14.27	0.850	21.59	0.320	8.13	0.350	8.89	5000
PFP1/2A	PFP1/2B	1/2"	0.705	17.91	1.040	26.42	0.320	8.13	0.500	12.70	3000
PFP3/4A	PFP3/4B	3/4"	0.987	25.07	1.310	33.27	0.320	8.13	0.630	16.00	1500
PFP1A	PFP1B	1"	1.130	28.70	1.530	38.86	0.320	8.13	0.630	16.00	1000

PFP Nylon Series
NPT Threaded Nylon Plugs (O-Ring Optional)



Specifications:

- Material: Nylon
- Color: Natural

Features:

- Unique head design allows the user to apply or remove this plug by hand or with a 12 point socket head, screwdriver or wrench
- Used to protect NPT threaded ports
- Optional O-Ring gives this part a watertight seal for superior leakage protection
- Recommended when strength and abrasion resistance are desired
- The nylon material absorbs paint, keeping paint flakes to a minimum
- Nylon is able to withstand higher temperatures than HDPE
- Temperature Range: -40°F - 230°F (-40°C - 110°C)

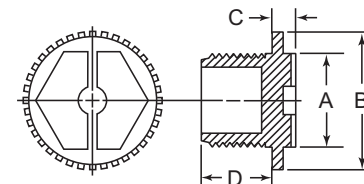

Item No.	Item No. w/ O-Ring	To Plug NPT Thread Size	A		B		C		D		Bulk Pack Qty
			in	mm	in	mm	in	mm	in	mm	
PFP1/8C	PFP1/8D	1/8" NPT	0.348	8.84	0.560	14.22	0.250	6.35	0.250	6.35	5000
PFP1/4C	PFP1/4D	1/4" NPT	0.489	12.42	0.740	18.80	0.310	7.87	0.310	7.87	5000
PFP3/8C	PFP3/8D	3/8" NPT	0.562	14.27	0.850	21.59	0.320	8.13	0.350	8.89	5000
PFP1/2C	PFP1/2D	1/2" NPT	0.705	17.91	1.040	26.42	0.320	8.13	0.500	12.70	3000
PFP3/4C	PFP3/4D	3/4" NPT	0.987	25.07	1.310	33.27	0.320	8.13	0.630	16.00	1500
PFP1C	PFP1D	1" NPT	1.130	28.70	1.530	38.86	0.320	8.13	0.630	16.00	1000



**TP Metric & TPBSP Series
 Metric & BSP Threaded Plugs**



Specifications:

- Material: Low-Density Polyethylene
- Color: Red

Features:

- Series accommodates an extensive range of metric and BSP/Gas threaded sizes
- Knurled head for easy grip
- Secure fit for excellent protection against dirt, moisture and corrosion

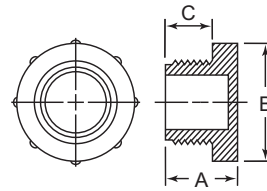

Metric Threads

Item No.	To Plug Metric Thread Size	A		B		C		Bulk Pack Qty
		in	mm	in	mm	in	mm	
12011A	M8 x 1	0.562	14.27	0.484	12.29	0.374	9.50	5000
12012A	M10 x 1	0.574	14.58	0.602	15.29	0.409	10.39	5000
12013A	M12 x 1	0.657	16.69	0.728	18.49	0.421	10.69	5000
12017A	M12 x 1.5	0.641	16.28	0.657	16.69	0.342	8.69	5000
12018A	M14 x 1.5	0.677	17.20	0.728	18.49	0.374	9.50	5000
12019A	M16 x 1.5	0.677	17.20	0.866	22.00	0.492	12.50	3000
10458A	M18 x 1.5	0.720	18.29	0.960	24.38	0.539	13.69	4000
12020A	M20 x 1.5	0.716	18.19	1.035	26.29	0.551	14.00	3000
10128A	M22 x 1.5	0.720	18.29	1.110	28.19	0.539	13.69	3000
12021A	M24 x 1.5	0.728	18.49	1.232	31.29	0.543	13.79	2000
12022A	M25 x 1.5	0.728	18.49	1.232	31.30	0.551	14.00	2500
12023A	M26 x 1.5	0.736	18.69	1.287	32.69	0.543	13.79	2000
12030A	M52 x 1.5	0.846	21.50	2.508	63.70	0.610	15.50	500

BSP/Gas Threads

Item No.	To Plug BSP/GAS Thread Size	A		B		C		Bulk Pack Qty
		in	mm	in	mm	in	mm	
10651A	1/8" x 28	0.413	10.50	0.646	16.40	0.165	4.20	5000
10588A	1/4" x 19	0.504	12.80	0.740	18.80	0.256	6.50	5000
10996A	3/8" x 19	0.472	12.00	0.902	22.90	0.217	5.50	5000
10590A	1/2" x 14	0.681	17.30	1.102	28.00	0.406	10.30	3000
10511A	5/8" x 14	0.724	18.40	1.232	31.30	0.547	13.90	2500
10731A	3/4" x 14	0.669	17.00	1.272	32.30	0.433	11.00	2000
11429B	7/8" x 14	0.713	18.10	1.496	38.00	0.531	13.50	1500
10810A	1" x 11	0.665	16.90	1.567	39.80	0.425	10.80	1500
10459A	1-1/4" x 11	0.823	20.90	1.965	49.90	0.591	15.00	800
11242A	1-1/2" x 11	0.665	16.90	2.173	55.20	0.425	10.80	600
10496A	2" x 11	0.689	17.50	2.902	73.70	0.421	10.70	400
10319A	3" x 11	0.650	16.50	4.134	105.00	0.445	11.30	150

We make finding your ideal product easy!

**NEED HELP? CALL US!
 800 847 0486**





TSSP Series
Sealing Threaded Plugs For Metric/BSP Threads

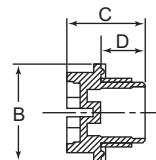
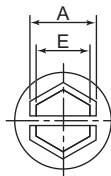

Specifications:

- Material: Nylon
- Color: Yellow

Features:

- The double sealing ring design on the underside of the flange provides a positive seal
- Design includes five complete threads for a secure fit
- Can be manually applied or removed with a screwdriver, spanner, socket or allen key or with power tools
- Head designed not to trap liquid
- The nylon material absorbs paint, keeping paint flakes to a minimum
- Temperature Range: -40°F - 320°F (-40°C - 160°C)
- See page 57 for UNF Threads



See pages 64 and 65 for Application Wizards

Metric Threads

Item No.	To Plug Metric Thread Size	A		B		C		D		E		Bulk Pack Qty
		in	mm	in	mm	in	mm	in	mm	in	mm	
462836A	M8 x 1	0.276	7.0	0.492	12.5	0.610	15.5	0.315	8.0	0.157	4.0	5000
462837A	M10 x 1	0.354	9.0	0.571	14.5	0.650	16.5	0.354	9.0	0.236	6.0	5000
TSSPM10X1.5A	M10 x 1.5	0.354	9.0	0.571	14.5	0.650	16.5	0.354	9.0	0.236	6.0	500
TSSPM12X1A	M12 x 1	0.394	10.0	0.669	17.0	0.650	16.5	0.354	9.0	0.276	7.0	500
462838A	M12 x 1.5	0.394	10.0	0.669	17.0	0.650	16.5	0.354	9.0	0.276	7.0	5000
462839A	M14 x 1.5	0.512	13.0	0.748	19.0	0.689	17.5	0.394	10.0	0.394	10.0	5000
462840A	M16 x 1.5	0.591	15.0	0.878	22.3	0.689	17.5	0.366	9.3	0.472	12.0	5000
462841A	M18 x 1.5	0.669	17.0	0.945	24.0	0.689	17.5	0.394	10.0	0.551	14.0	3000
462842A	M20 x 1.5	0.748	19.0	1.024	26.0	0.689	17.5	0.394	10.0	0.630	16.0	3000
462843A	M22 x 1.5	0.827	21.0	1.102	28.0	0.689	17.5	0.394	10.0	0.709	18.0	3000
TSSPM24X1.5A	M24 x 1.5	0.945	24.0	1.181	30.0	0.689	17.5	0.394	10.0	0.827	21.0	500
TSSPM26X1.5A	M26 x 1.5	0.945	24.0	1.260	32.0	0.807	20.5	0.472	12.0	0.827	21.0	500
466977A	M27 x 1.5	0.945	24.0	1.299	33.0	0.807	20.5	0.472	12.0	0.827	21.0	500
466985A	M27 x 2	0.945	24.0	1.299	33.0	0.866	22	0.531	13.5	0.827	21.0	250
TSSPM28X1.5A	M28 x 1.5	0.945	24.0	1.339	34.0	0.807	20.5	0.472	12.0	0.827	21.0	500
TSSPM30X1.5A	M30 x 1.5	0.945	24.0	1.496	38.0	0.807	20.5	0.472	12.0	0.827	21.0	500
TSSPM30X2A	M30 x 2	0.945	24.0	1.496	38.0	0.866	22	0.531	13.5	0.827	21.0	250
TSSPM32X1.5A	M32 x 1.5	0.945	24.0	1.575	40.0	0.807	20.5	0.472	12.0	0.827	21.0	500
TSSPM33X2A	M33 x 2	0.945	24.0	1.575	40.0	0.866	22	0.531	13.5	0.827	21.0	250
TSSPM36X1.5A	M36 x 1.5	0.945	24.0	1.772	45.0	0.807	20.5	0.472	12.0	0.827	21.0	500
TSSPM36X2A	M36 x 2	0.945	24.0	1.772	45.0	0.866	22	0.531	13.5	0.827	21.0	250
TSSPM38X1.5A	M38 x 1.5	0.945	24.0	1.890	48.0	0.807	20.5	0.472	12.0	0.827	21.0	250
TSSPM42X2A	M42 x 2	1.181	30.0	1.969	50.0	0.866	22	0.531	13.5	1.063	27.0	250
TSSPM45X1.5A	M45 x 1.5	1.181	30.0	2.047	52.0	0.846	21.5	0.472	12.0	1.063	27.0	250
TSSPM45X2A	M45 x 2	1.181	30.0	1.969	50.0	0.866	22	0.531	13.5	1.063	27.0	250
TSSPM48X2A	M48 x 2	1.181	30.0	2.165	55.0	0.906	23	0.531	13.5	1.063	27.0	100
TSSPM52X1.5A	M52 x 1.5	1.181	30.0	2.362	60.0	0.866	22	0.472	12.0	1.063	27.0	250
TSSPM52X2A	M52 x 2	1.181	30.0	2.362	60.0	0.906	23	0.531	13.5	1.063	27.0	100

BSP/Gas Threads

Item No.	To Plug BSP/GAS Thread Size	A		B		C		D		E		Bulk Pack Qty
		in	mm	in	mm	in	mm	in	mm	in	mm	
462882A	1/8" x 28	0.472	12.00	0.630	16.00	0.610	15.50	0.315	8.00	0.354	9.00	5000
462848A	1/4" x 19	0.512	13.00	0.748	19.00	0.689	17.50	0.394	10.00	0.394	10.00	5000
462849A	3/8" x 19	0.591	15.00	0.866	22.00	0.689	17.50	0.394	10.00	0.472	12.00	5000
462850A	1/2" x 14	0.748	19.00	1.063	27.00	0.768	19.50	0.472	12.00	0.630	16.00	3000
462851A	3/4" x 14	0.945	24.00	1.260	32.00	0.768	19.50	0.472	12.00	0.827	21.00	2000
462852A	1" x 11	1.181	30.00	1.575	40.00	0.886	22.50	0.591	15.00	1.063	27.00	1000
462853A	1-1/4" x 11	1.417	36.00	1.969	50.00	0.886	22.50	0.591	15.00	1.299	33.00	400



HDPE Metric Threaded O-Ring Plugs



Specifications:

- Material: High-Density Polyethylene
- Color: Yellow

Features:

- Can be applied or removed by spanner, screwdriver or socket, or by hand

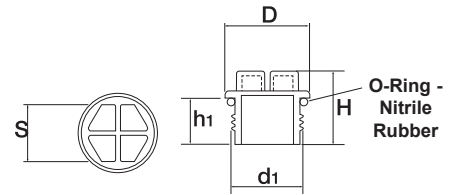

Item No.	To Plug Metric Thread Size	D	H	h1	S	Bulk Pack Qty
	d1	mm	mm	mm	mm	
498659	M8 x 1	12.5	17.0	10.0	6.0	500
498660	M10 x 1	14.5	17.2	10.0	7.0	500
498661	M12 x 1	17.0	17.2	10.0	10.0	500
498662	M10 x 1.5	14.5	19.2	12.0	7.0	500
498663	M12 x 1.5	17.0	19.2	12.0	10.0	500
498664	M14 x 1.5	22.0	19.2	12.0	10.0	500
498540	M16 x 1.5	24.0	20.4	12.0	13.0	500
498541	M18 x 1.5	24.0	20.4	12.0	13.0	500
498542	M20 x 1.5	26.0	20.4	12.0	15.0	250
498665	M22 x 1.5	28.0	20.4	12.0	15.0	250
498543	M24 x 1.5	30.0	20.4	12.0	17.0	250
498544	M26 x 1.5	32.0	20.4	12.0	19.0	250
498546	M30 x 1.5	38.0	20.6	12.0	22.0	250
498547	M32 x 1.5	40.0	20.6	12.0	24.0	250
498666	M36 x 1.5	45.0	20.6	12.0	24.0	100
498667	M38 x 1.5	48.0	20.6	12.0	24.0	100
498668	M27 x 2.0	33.0	24.6	15.0	19.0	250
498548	M30 x 2.0	38.0	24.6	15.0	22.0	250
498549	M33 x 2.0	40.0	24.6	15.0	24.0	250
498550	M36 x 2.0	45.0	24.6	15.0	24.0	100
498669	M42 x 2.0	50.0	24.6	15.0	24.0	100
498551	M45 x 2.0	52.0	25.0	15.0	30.0	100
498670	M48 x 2.0	55.0	25.0	15.0	30.0	100
498671	M52 x 2.0	60.0	25.0	15.0	7.0	100

Nylon Metric Threaded O-Ring Plugs



Specifications:

- Material: Nylon
- Color: Orange

Features:

- Metric thread
- Can be applied or removed by spanner, screwdriver or socket, or by hand
- Nylon is recommended where higher abrasion and slightly higher temperatures are needed where a polyethylene plug will not work

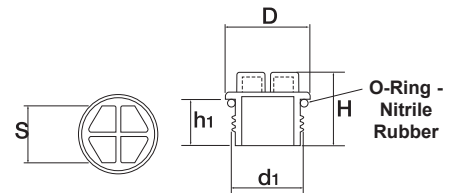

Item No.	To Plug Metric Thread Size	D	H	h1	S	Bulk Pack Qty
	d1	mm	mm	mm	mm	
900535	M8 x 1	12.5	17.0	10.0	6.0	500
900536	M10 x 1	14.5	17.2	10.0	7.0	500
900537	M12 x 1	17.0	17.2	10.0	10.0	500
900538	M10 x 1.5	14.5	19.2	12.0	7.0	500
900539	M12 x 1.5	17.0	19.2	12.0	10.0	500
900540	M14 x 1.5	22.0	19.2	12.0	10.0	500
900541	M16 x 1.5	24.0	20.4	12.0	13.0	500
900542	M18 x 1.5	24.0	20.4	12.0	13.0	500
900543	M20 x 1.5	26.0	20.4	12.0	15.0	250
900544	M22 x 1.5	28.0	20.4	12.0	15.0	250
900545	M24 x 1.5	30.0	20.4	12.0	17.0	250
900546	M26 x 1.5	32.0	20.4	12.0	19.0	250
900547	M30 x 1.5	38.0	20.6	12.0	22.0	250
900548	M32 x 1.5	40.0	20.6	12.0	24.0	250
900549	M36 x 1.5	45.0	20.6	12.0	24.0	100
900550	M38 x 1.5	48.0	20.6	12.0	24.0	100
900551	M27 x 2.0	33.0	24.6	15.0	19.0	250
900552	M30 x 2.0	38.0	24.6	15.0	22.0	250
900553	M33 x 2.0	40.0	24.6	15.0	24.0	250
900554	M36 x 2.0	45.0	24.6	15.0	24.0	100
900555	M42 x 2.0	50.0	24.6	15.0	24.0	100
900556	M45 x 2.0	52.0	25.0	15.0	30.0	100
900557	M48 x 2.0	55.0	25.0	15.0	30.0	100
900558	M52 x 2.0	60.0	25.0	15.0	7.0	100

**PROPANE VALVE PRODUCT CAPS & THREADED PLUGS****PPC Series****Overfill Prevention Device Cylinder Valve Caps**

PPC1A



PPC3RC

Specifications:

- Material: See Table
- Color: See Table

Features:

- Protects threads from damage and contaminants during shipping and use
- Easy to apply
- PPC1A - dust cap and retaining strap with warning labels imprinted in English and Spanish
- PPC3RC is a protective cap with an internal ring and tear feature

Item No.	Material	Color	Product Usage	Bulk Pack Qty
PPC1A	LDPE	Black	OPD Valve for Propane Cylinder	550
PPC3RC	LLDPE	Blue	OPD Valve for Propane Cylinder	900

K Series**Overfill Prevention Device Cylinder Valve Plugs**

Specifications:

- Material: High-Density Polyethylene
- Color: Red

Features:

- Protects threads from damage and contaminants during shipping and use
- Easy to apply
- Flat strap attachment device

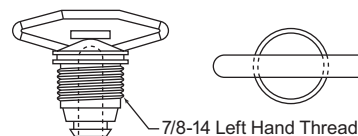

Item No.	Description	Product Usage	Bulk Pack Qty
K737AC	100 Per Bag with Tag	OPD Valve for Propane Cylinder	1000

DP Series**UNJ/UNJS Threaded Plugs**

Specifications:

- Material: High-Density Polyethylene
- Color: Red

Features:

- Protects threaded components from dust, moisture and damage during production, storage and shipment
- Designed with an easy to grip head for ease of hand installation
- Threads meet UNJ and UNJS specifications

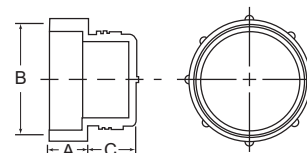

Item No.	To Plug UNJ/UNJS Thread Size	Tubing Size		A		B		C		Bulk Pack Qty
		in	mm	in	mm	in	mm			
DP3A	3/8"-28	3/16	0.250	6.35	0.440	11.18	0.280	7.11	5000	
DP4A	7/16"-24	1/4	0.310	7.87	0.560	14.22	0.300	7.62	5000	
DP5A	1/2"-24	5/16	0.310	7.87	0.620	15.75	0.300	7.62	5000	
DP6A	9/16"-20	3/8	0.310	7.87	0.690	17.53	0.320	8.13	5000	
DP8A	23/32"-20	1/2	0.310	7.87	0.880	22.35	0.320	8.13	5000	
DP10A	27/32"-18	5/8	0.310	7.87	1.000	25.40	0.400	10.16	2500	
DP12A	1"-16	3/4	0.310	7.87	1.120	28.45	0.420	10.67	2500	
DP14A	1-1/8"-16	7/8	0.250	6.35	1.250	31.75	0.450	11.43	2500	
DP16A	1-1/4"-14	1	0.250	6.35	1.380	35.05	0.450	11.43	2000	
DP20A	1-33/64"-14	1-1/4	0.250	6.35	1.620	41.15	0.450	11.43	1000	
DP21SA	1-37/64"-14	1-1/4	0.250	6.35	1.750	44.45	0.460	11.68	1000	
DP24A	1-25/32"-14	1-1/2	0.250	6.35	2.000	50.80	0.550	13.97	1000	
DP25SA	1-27/32"-14	1-1/2	0.250	6.35	2.120	53.85	0.550	13.97	1000	



FNC Series Flexible Protective Netting (Tector-Net)

Specifications:

- Material: Low-Density Polyethylene
- Color: See Table

Features:

- Easily applied and removed
- Reduces labor cost, inventory cost, damage claims and returns
- Does not trap or retain moisture
- Stretches and wraps snugly around virtually any form

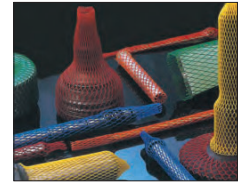
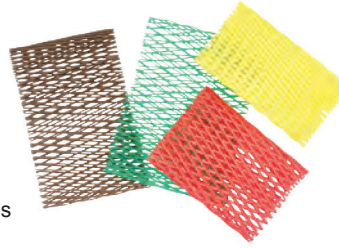

Item No.	Color	Ø Flexible Range		Roll Length		Pack Qty
		in	mm	Ft	M	
FNC00250037S	Red	0.250 - 0.375	6.35 - 9.53	820	249	1
FNC00250037L	Red	0.250 - 0.375	6.35 - 9.53	1500	457	1
FNC00250050S	Orange	0.375 - 0.500	6.35 - 12.70	820	249	1
FNC00250050L	Orange	0.375 - 0.500	6.35 - 12.70	1500	457	1
FNC00500100S	Blue	0.500 - 1.000	12.70 - 25.40	820	249	1
FNC00500100L	Blue	0.500 - 1.000	12.70 - 25.40	1500	457	1
FNC01000200S	Yellow	1.000 - 2.000	25.40 - 50.80	164	49	1
FNC01000200L	Yellow	1.000 - 2.000	25.40 - 50.80	1500	457	1
FNC02000400S	Red	2.000 - 4.000	50.80 - 101.60	164	49	1
FNC02000400L	Red	2.000 - 4.000	50.80 - 101.60	1500	457	1
FNC04000600S	Green	4.000 - 6.000	101.60 - 152.40	164	49	1
FNC06000800S	Brown	6.000 - 8.000	152.40 - 203.20	164	49	1
FNC1000SRA	Green	10.000 - 12.000	254.00 - 304.80	82	24	1

FNH Series Heavy Gauge Protective Netting

Specifications:

- Material: Low-Density Polyethylene
- Color: See Table

Features:

- Easily applied and removed
- Reduces labor cost, inventory cost, damage claims and returns
- Does not trap or retain moisture
- Stretches and wraps snugly around virtually any form
- Has heavier gauge material for applications that need a more durable protection

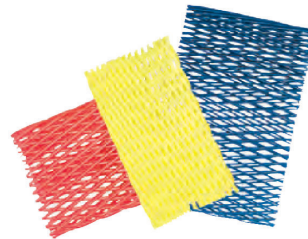

Item No.	Color	Ø Flexible Range		Roll Length		Pack Qty
		in	mm	Ft	M	
FNH0050LRA	Blue	0.500 - 1.000	12.70 - 25.40	820	249	1
FNH0125A	Yellow	1.250 - 1.625	31.75 - 41.28	82	24	1
FNH0200A	Red	2.000 - 2.500	50.80 - 63.50	82	24	1
FNH0250A	Green	2.500 - 3.000	63.50 - 76.20	82	24	1
FNH0300A	Green	3.000 - 4.000	76.20 - 101.60	82	24	1
FNH0400A	Yellow	4.000 - 4.500	101.60 - 114.30	82	24	1
FNH0475A	Red	4.750 - 5.500	120.65 - 139.70	82	24	1
FNH0550A	Blue	5.500 - 6.750	139.70 - 171.45	82	24	1
FNH0675A	Green	6.750 - 8.000	171.45 - 203.20	82	24	1



HASSLE-FREE SERVICE



Our teams of knowledgeable, dedicated employees are committed to providing a hassle-free experience from sampling and quoting through delivery. Call us today!



Tube & Hydraulic Fittings

Caps

Non-Threaded Caps Choices



Numbered Series
Pages 24 - 26



E Series
Page 33



TS Series
Page 34



DM Series
Pages 29 - 30



TCUNF Series
Page 39



G Series
Page 39

Your Application			Non-Threaded Cap Choices				Threaded Cap Choices		
Thread Size	Tube Size	Fitting Size	Numbered Series	E Series	TS Series	DM Series	TCUNF Series	G Series	
5/16 - 24	1/8	-2	008A	—	—	DM0304-1/2A	—	—	
3/8 - 24	3/16	-3	011A	E3/8A	TS3A	DM0360-1/2A	10251A	G1A	
7/16 - 20	1/4	-4	013A	E7/16A	TS4A	DM0437-1/2A	10332A	G2A	
1/2 - 20	5/16	-5	017A	E1/2A	TS5A	DM0490-1/2A	10528A	G5A	
9/16 - 18	3/8	-6	020A	E9/16A	TS6A	DM0544-1/2A	11041A	G6A	
5/8 - 18	3/8	—	021A	E5/8A	TS10348A	DM0600-1A	10653A	G11A	
11/16 - 16	—	-7	026A	E11/16B	TS7A	DM0665-1A	—	—	
3/4 - 16	1/2	-8	028A	E3/4A	TS8A	DM0725-1A	12847A	G14A	
13/16 - 16	—	-9	030A	E13/16A	TS9A	DM0750-1A	12825A	—	
7/8 - 14	5/8	-10	035A	E7/8A	TS10A	DM0843-1A	11089A	G17A	
1 - 14	—	-11	041A	E1A	TS11A	DM0985-1A	12826A	G21A	
1 - 1/16 - 12	3/4	-12	042A	E1-1/16A	TS12A	DM1000-1A	10685A	G22A	
1 - 3/16 - 12	7/8	-13	1040A	E1-3/16B	TS13A	DM1125-1A	10163A	G25A	
1 - 5/16 - 12	1	-16	049A	E1-5/16B	TS16A	DM1250-1A	10151A	G27A	
1 - 7/16 - 12	—	-17	053A	E1-7/16B	TS17A	DM1375-1A	10185A	—	
1 - 5/8 - 12	1-1/4	-20	056A	E1-5/8B	TS20A	DM1593-1A	11053A	G30A	
1 - 11/16 - 12	—	-21	056A	E1-11/16B	TS21A	DM1625-1A	—	—	
1 - 7/8 - 12	1-1/2	-24	062A	E1-7/8B	TS24A	DM1875-1A	11804A	—	
2 - 1/4 - 12	1-3/4	-28	072A	—	—	DM2156-1A	—	—	

Plugs

Non-Threaded Plug Choices



Numbered Series
Pages 24 - 26



CP Series
Page 43

Threaded Plug Choices



TPUNF Series
Page 55



BL Series
Page 54



BLM Series
Page 55



BLWF Series
Page 57

Your Application			Non-Threaded Plug Choices			Threaded Plug Choices			
Thread Size	Tube Size	Fitting Size	Numbered Series	CP Series	TPUNF Series	BL Series	BLM Series	BLWF Series	
5/16 - 24	1/8	-2	005A	CP5A	10709A	—	—	—	
3/8 - 24	3/16	-3	007A	CP7A	10692A	—	—	—	
7/16 - 20	1/4	-4	008A	CP8A	10763A	BL3A	BLM3B	BLWF100A	
1/2 - 20	5/16	-5	010A	CP10A	10696A	B4A	BLM4B	BLWF105A	
9/16 - 18	3/8	-6	013A	CP14A	10668A	BL5A	BLM5B	BLWF110A	
5/8 - 18	3/8	—	014A	CP15B	10940A	B6A	BLM6B	—	
3/4 - 16	1/2	-8	021A	CP19A	10575A	BL7A	BLM7B	BLWF115A	
7/8 - 14	5/8	-10	026A	CP24A	10326A	BL8A	BLM8B	BLWF120A	
1 - 14	—	—	030A	CP31A	12785A	B9A	BLM9B	—	
1 - 1/16 - 12	3/4	-12	035A	CP35A	10460A	BL10A	BLM10B	BLWF125A	
1 - 3/16 - 12	7/8	-13	041A	CP40A	11506A	BL11A	BLM11B	BLWF130A	
1 - 5/16 - 12	1	-16	044A	CP44A	10671A	BL12A	BLM12B	BLWF135A	
1 - 5/8 - 12	1 - 1/4	-20	052A	CP55A	11752A	BL13A	BLM13B	BLWF140A	
2 - 1/4 - 12	1 - 3/4	-28	066A	CP61A	—	—	—	—	

Threaded NPT Fittings

Caps



Numbered Series
Pages 24 - 26



Y Series
Page 34



DM Series
Pages 29 - 30



ECS Series
Page 33

Your Application				
To Cap NPT Thread Size	Numbered Series	Y Series	DM Series	ECS Series
1/8	011A	Y1/8A	DM0375-1/2A	ECS0125A
1/4	018A	Y1/4A	DM0500-1/2A	ECS0250A
3/8	022A	Y3/8A	DM0625-1/2A	ECS0375A
1/2	028A	Y1/2A	DM0843-1A	ECS0500A
3/4	040A	Y3/4A	DM1000-1A	ECS0750A
1	045A	Y1A	DM1250-1A	ECS1000A
1 - 1/4	056A	Y1 - 1/4A	DM1875-1A	ECS1250A
1 - 1/2	060A	Y1 - 1/2A	DM2375-1A	ECS1500A
2	071A	Y2A	DM2750-1A	ECS2000A

Plugs



Numbered Series
Pages 24 - 26



CP Series
Page 43



R Series
Page 58



PFP Series
Page 58

Your Application				
To Plug NPT Thread Size	Numbered Series	CP Series	R Series	PFP Series
1/8	008A	CP8A	R1/8A	PFP1/8A
1/4	011A	CP11A	R1/4A	PFP1/4A
3/8	017A	—	R3/8A	PFP3/8A
1/2	023A	CP23A	R1/2A	PFP1/2A
3/4	035A	CP35A	R3/4A	PFP3/4A
1	042A	CP44A	R1A	PFP1A
1 - 1/4	054A	CP55A	R1 - 1/4A	—
1 - 1/2	057A	CP57A	R1 - 1/2A	—
2	066A	—	R2A	—



Metric Threads

Caps



Your Application				
Thread Size	Numbered Series	DM Series	A & AR Series	TC Metric Series
M4	004A	DM0148-1/2A	A5/32W/RA	—
M5	005A	DM0187-1/2A	—	—
M6	006A	DM0224-1/2A	—	—
M8 x 1	009A	DM0304-1/2A	A5/16W/RA	12100A
M10 x 1	012A	DM0375-1/2A	AR100A	12101A
M12 x 1	014A	DM0460-1/2A	A1/2BA	12102A
M12 x 1.5	1015A	DM0460-1/2A	A1/2BA	12103A
M14 x 1.5	018A	DM0531-1/2A	—	12104A
M16 x 1.5	022A	DM0600-1A	A5/8W/RA	12105A
M18 x 1.5	027A	DM0687-1A	A11/16W/RA	12106A
M20 x 1.5	030A	DM0750-1A	AR125A	12107A
M22 x 1.5	035A	DM0843-1A	AR130A	12108A
M24 x 1.5	040A	DM0937-1A	A15/16A	12109A
M25 x 1.5	041A	—	A63/64A	12110A
M26 x 1.5	041A	DM1000-1A	A1W/RA	12111A
M27	042A	DM1062-1A	A1-1/16W/RA	—
M28 x 1.5	044A	DM1090-1A	—	12967A
M30 x 2	1050A	DM1125-1A	—	12122A
M35	051A	DM1375-1A	A1-3/8A	—
M39	055A	DM1500-1A	A1-1/2A	—
M42 x 2	056A	DM1625-1A	A1-5/8A	12124A
M45	058A	DM1750-1A	A1-3/4A	—
M48	064A	DM1875-1A	A1-7/8A	—
M52 x 2	1085A	DM2125-1A	—	12126A
M58	075A	DM2250-1A	A2-1/4A	—

Caps

Non-Threaded Studs



To Cap OD			Numbered Series	A Series	DM Series
in	dec.	mm			
1/8	0.125	3.17	002A	A1/8W/RA	DM0125-1/2A
3/16	0.187	4.75	005A	A3/16W/RA	DM0187-1/2A
1/4	0.250	6.35	007A	A1/4W/RA	DM0250-1/2A
5/16	0.312	7.92	009A	A5/16W/RA	DM0313-1/2A
3/8	0.375	9.53	011A	A3/8W/RA	DM0375-1/2A
7/16	0.437	11.10	014A	A7/16W/RA	DM0437-1/2A
1/2	0.500	12.70	1020A	A1/2W/RA	DM0500-1A
9/16	0.562	14.27	020A	A9/16W/RA	DM0562-1A
5/8	0.625	15.88	022A	A5/8W/RA	DM0625-1A
11/16	0.687	17.45	026A	A11/16W/RA	DM0687-1A
3/4	0.750	19.05	028A	A3/4W/RA	DM0750-1A
13/16	0.812	20.62	031A	A13/16W/RA	DM0812-1A
7/8	0.875	22.23	039A	A7/8W/RA	DM0875-1A
15/16	0.937	23.80	040A	A15/16A	DM0937-1A
1	1.000	25.40	041A	A1W/RA	DM1000-1A
1 - 1/16	1.062	26.97	042A	A1-1/16W/RA	DM1062-1A
1 - 1/8	1.125	28.58	1040A	A1-1/8A	DM1125-1A
1 - 3/16	1.187	30.15	045A	A1-3/16W/RA	DM1187-1A
1 - 1/4	1.250	31.75	048A	A1-1/4A	DM1250-1A
1 - 5/16	1.312	33.32	051A	A1-5/16W/RA	DM1312-1A
1 - 3/8	1.375	34.93	052A	A1-3/8A	DM1375-1A
1 - 7/16	1.437	36.50	053A	A1-7/16A	DM1437-1A
1 - 1/2	1.500	38.10	055A	A1-1/2A	DM1500-1A
1 - 9/16	1.562	39.67	055A	A1-9/16A	—
1 - 5/8	1.625	41.28	056A	A1-5/8A	DM1625-1A
1 - 11/16	1.687	42.85	057A	A1-11/16A	DM1687-1A
1 - 3/4	1.750	44.45	059A	A1-3/4A	DM1750-1A
1 - 13/16	1.812	46.02	060A	—	DM1812-1A
1 - 7/8	1.875	47.63	062A	A1-7/8A	DM1875-1A
1 - 15/16	1.937	49.20	063A	—	DM1937-1A
2	2.000	50.80	065A	A2A	DM2000-1A

Plugs



Your Application					
Thread Size	Numbered Series	BP Series	TP Metric	TSSP Series	SF Series
M6	002A	BP1012A	—	—	—
M8 x 1	005A	BP1018A	12011A	462836A	—
M10 x 1	007A	BP1026A	12012A	462837A	10530A
M12 x 1	010A	BP1038A	12013A	—	12363A
M12 x 1.5	009A	BP1034A	12017A	462838A	12363A
M14 x 1.5	012A	BP1044A	12018A	462839A	12363A
M16 x 1.5	015A	BP1056A	12019A	462840A	12364A
M18 x 1.5	018A	BP1060A	10458A	462841A	10314B
M20 x 1.5	022A	BP1068A	12020A	462842A	12365A
M22 x 1.5	026A	BP1074A	10128A	462843A	12366A
M24 x 1.5	028A	BP1086A	12021A	—	12621A
M26 x 1.5	030A	BP1092A	12023A	—	12367A
M27	035A	BP1100A	—	—	—
M28	040A	BP1102A	—	—	12368A
M30	041A	BP1106A	—	—	—
M32	044A	BP1112A	—	—	12369A
M33	044A	BP1114A	—	—	—
M36 x 2	045A	BP1116A	—	—	12622A
M38	048A	BP1126A	—	—	—
M42 x 2	053A	BP1134A	—	—	12598A
M52 x 2	1080A	BP1142A	—	—	—

Plugs

Non-Threaded Holes



To Plug ID			Numbered Series	FT Series	CP Series
in	dec.	mm			
1/8	0.125	3.17	001A	10874A	—
3/16	0.187	4.75	1000A	12665A	—
1/4	0.250	6.35	003A	12667A	CP4A
5/16	0.312	7.92	006A	12668A	CP6A
3/8	0.375	9.53	008A	12670A	CP8A
7/16	0.437	11.10	010A	12671A	CP10A
1/2	0.500	12.70	012A	12673A	CP12A
9/16	0.562	14.27	014A	12675A	CP14A
5/8	0.625	15.88	017A	12677A	CP16A
11/16	0.687	17.45	020A	12679A	CP19A
3/4	0.750	19.05	023A	12680A	CP23A
13/16	0.812	20.62	026A	12683A	CP24A
7/8	0.875	22.23	028A	12684A	CP29A
15/16	0.937	23.80	030A	12686A	CP31A
1	1.000	25.40	035A	12688A	CP35A
1 - 1/16	1.062	26.97	040A	12689A	CP37A
1 - 1/8	1.125	28.58	041A	12691A	CP40A
1 - 3/16	1.187	30.15	042A	12692A	CP42A
1 - 1/4	1.250	31.75	044A	—	CP44A
1 - 5/16	1.312	33.32	045A	—	CP46A
1 - 3/8	1.375	34.93	1055A	—	CP49A
1 - 7/16	1.437	36.50	048A	—	CP49A
1 - 1/2	1.500	38.10	051A	—	CP51A
1 - 9/16	1.562	39.67	052A	12693A	CP55A
1 - 5/8	1.625	41.28	055A	—	CP56A
1 - 11/16	1.687	42.85	056A	—	CP56A
1 - 3/4	1.750	44.45	1065A	—	CP59A
1 - 13/16	1.812	46.02	057A	12694A	CP59A
1 - 7/8	1.875	47.63	1070A	—	CP57A
1 - 15/16	1.937	49.20	1075A	—	CP57A
2	2.000	50.80	1080A	—	—