

## Tri Band Antenna for Wi-Fi 6E

### 1. Features

- LAN 2.4 – 2.5 GHz / 5.15 - 5.85 GHz / 5.925 - 7.125 GHz 2.4 – 2.5 GHz / 5.15 - 5.85 GHz / 5.925 – 7.125 GHz Antenna for WLAN
- Compact size
- High efficiency
- Surface mount device
- Embossed reel package

### 2. Part Number

RAC002456-R

2400 (2400-pieces/reel)

### 3. Shape dimensions and height

#### 3.1. Shape

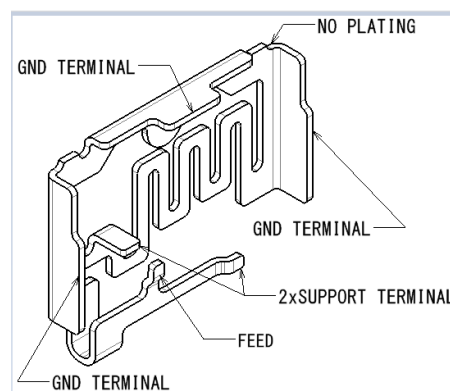
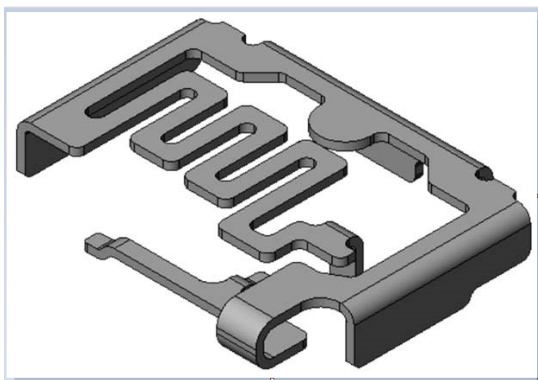

**3.2. Dimensions**

13.0 (width) x 10.5 (depth) x 2 (height) mm

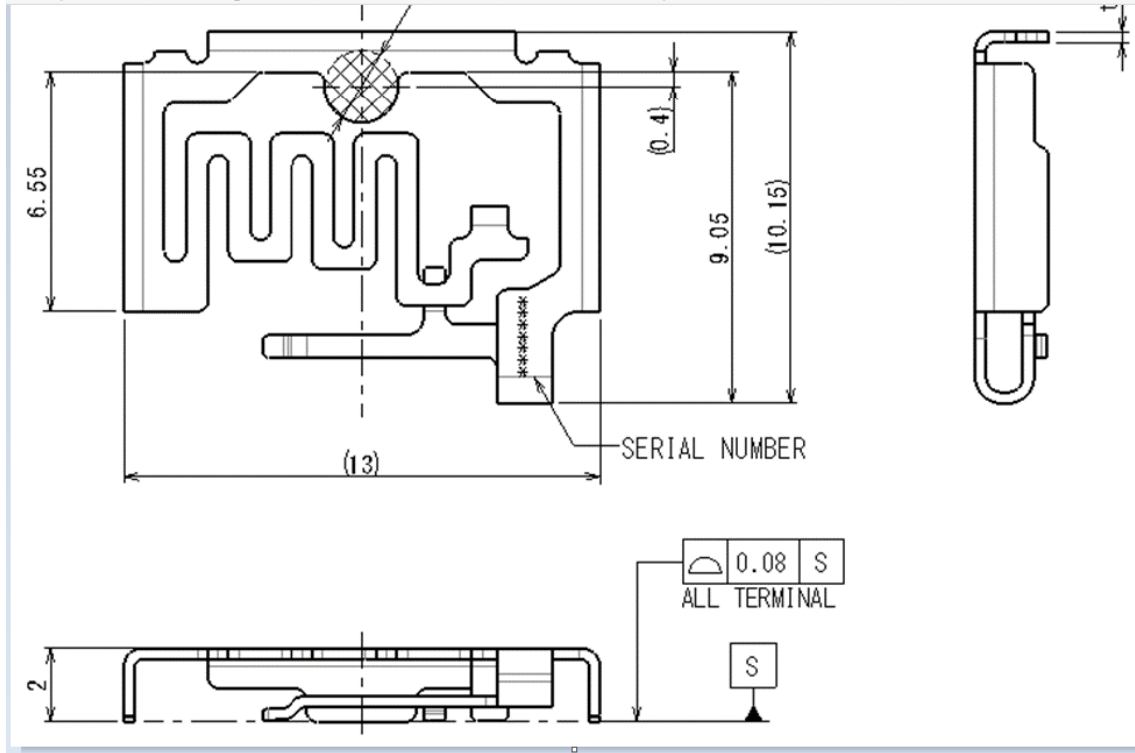

**3.3. Weight**

0.25 g (typical)

**3.4. Plating**

None

**3.5. Type**

Split ring

**3.6. Material**

Copper Alloy

## 4. RF Characteristics

### 4.1. Frequency Range

2.4 - 2.5 GHz / 5.15 - 5.85 GHz / 5.925 – 7.125 GHz

### 4.2. Impepedance

50

### 4.3. Voltage standing wave ratio (VSWR)

50 x 30 mm VSWR

VSWR characteristics of the antenna on a 50 x 30-mm reference board

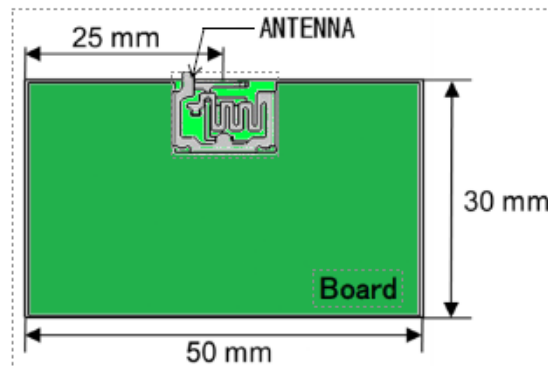

VSWR < 2.0 (Frequency range: 2.4 -2.5 GHz / 5.15 - 5.85 GHz / 5.925 – 7.125 GHz)

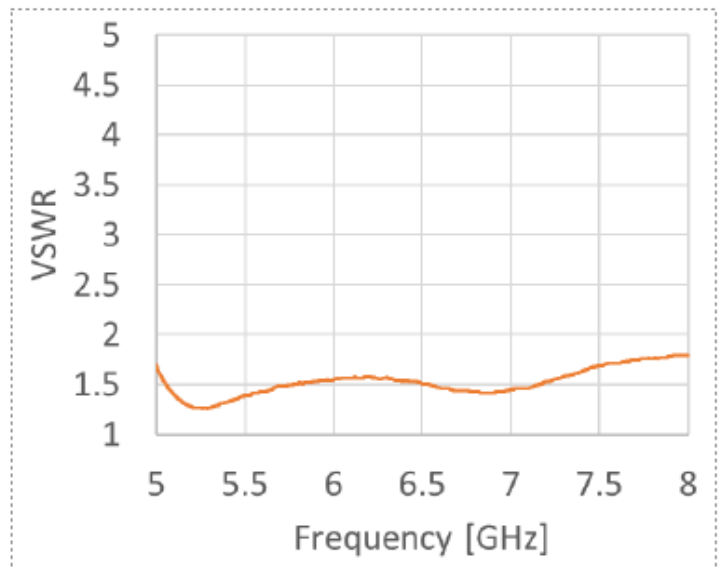
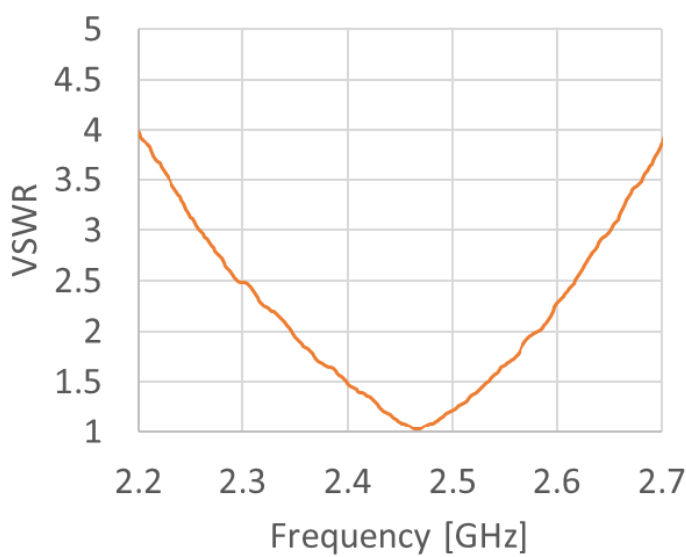

#### 4.4. Radiation efficiency:

50 x 30 mm

Radiation efficiency of the antenna mounted on a 50 x 30-mm reference board (excluding cable and feeder-line loss)

Radiation efficiency > 85 % (Frequency range: 2.4 – 2.5 GHz),

> 70 % (Frequency range: 5.15 - 5.85 GHz /  
5.915 – 7.125 GHz)

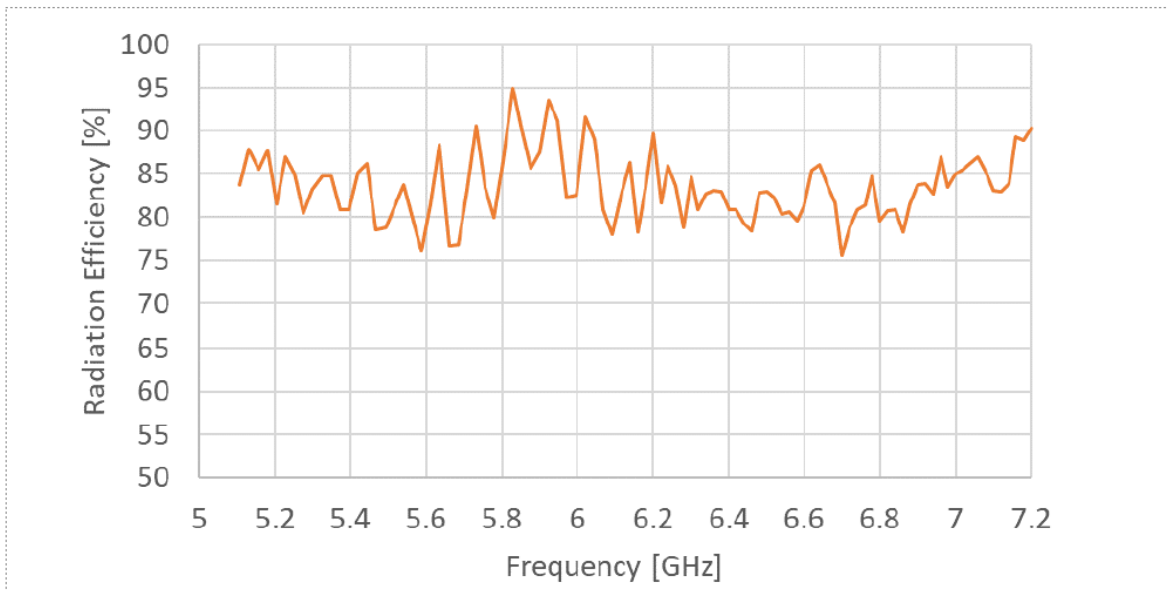
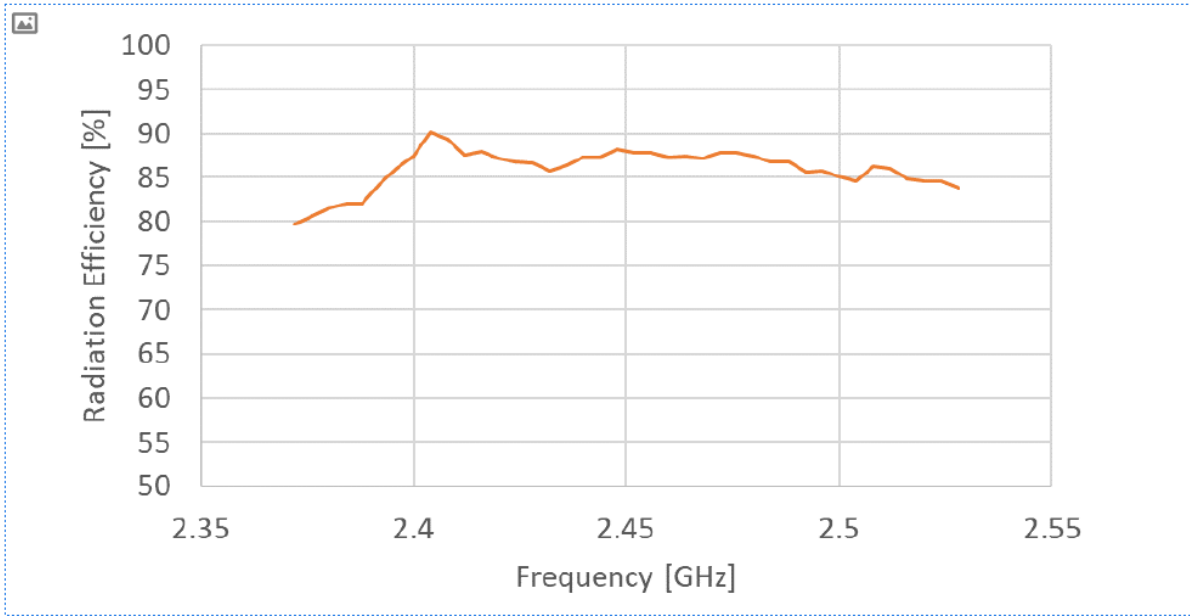

### 4.5. Radiation Pattern

50 x 30 mm

Radiation pattern of the antenna mounted on a 50 x 30-mm reference board

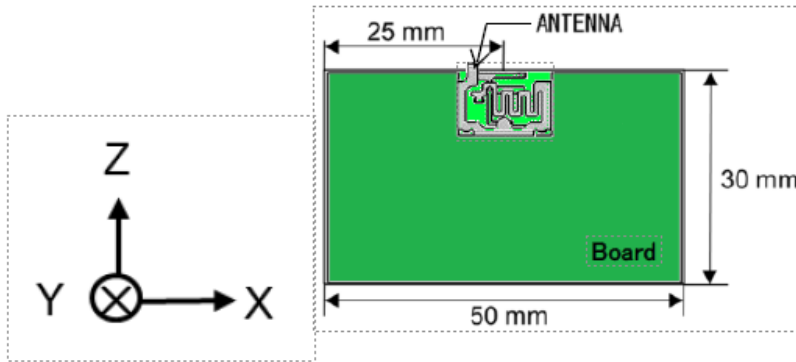

### Radiation pattern

2.4 GHz

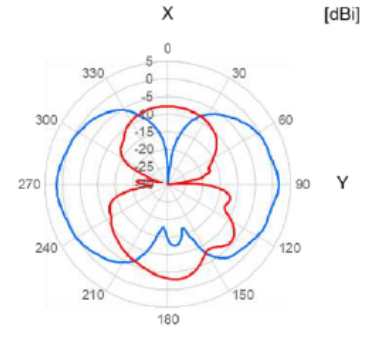
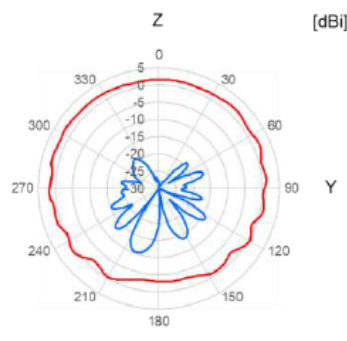
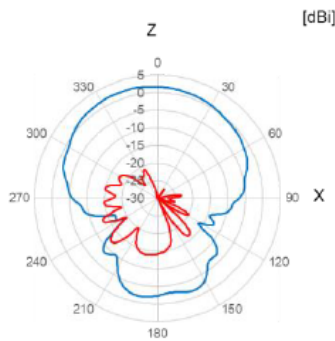

2.5 GHz

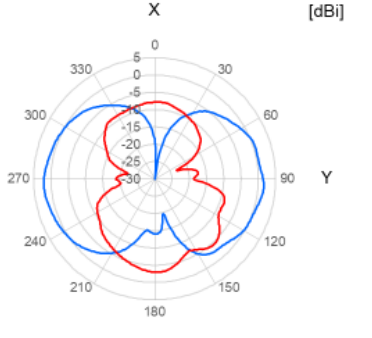
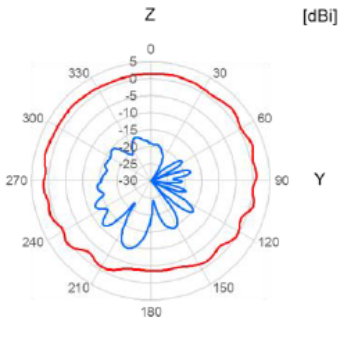
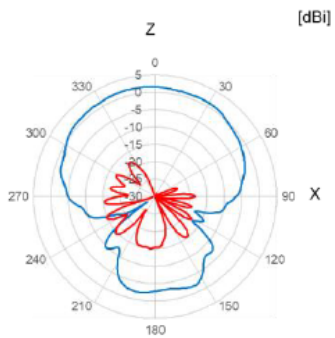

Radiation pattern

**5.15 GHz**

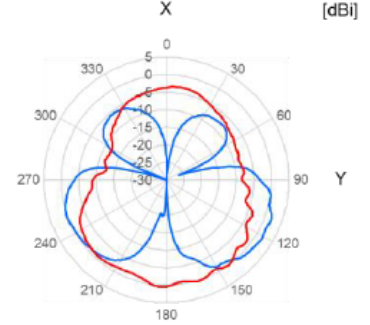
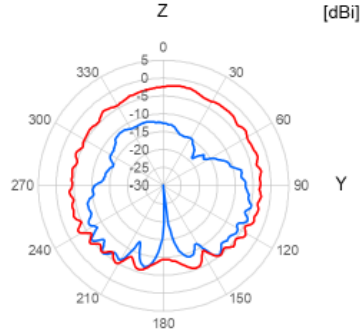
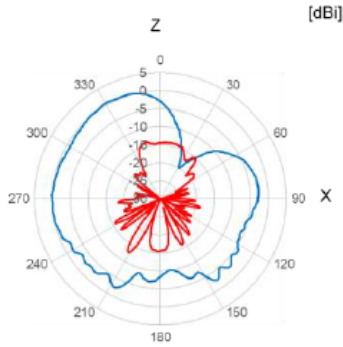

**5.85 GHz**

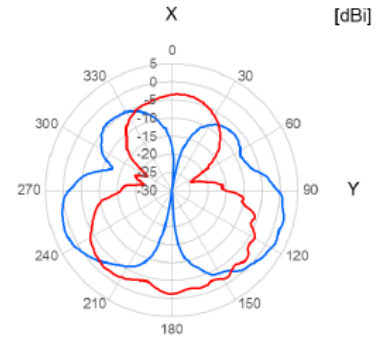
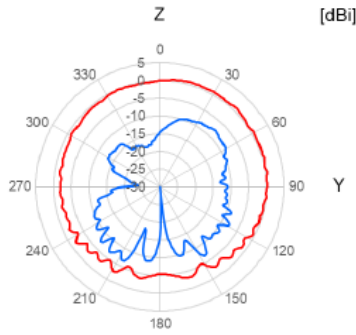
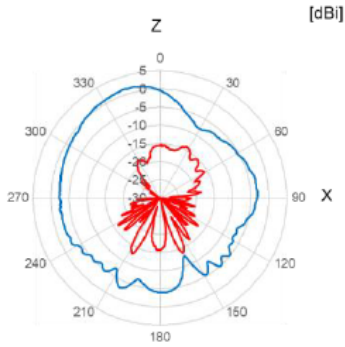

**5.925 GHz**

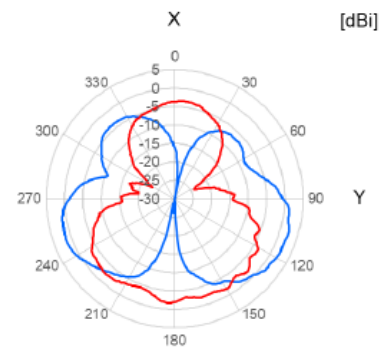
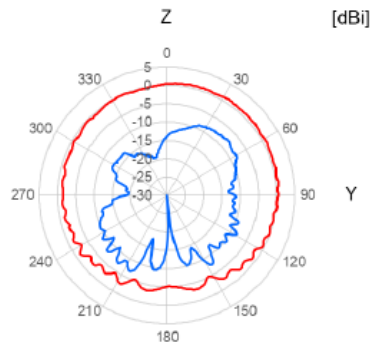
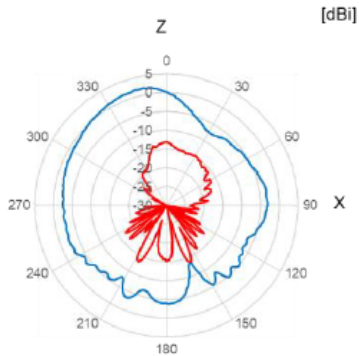

## Radiation pattern

7.125 GHz

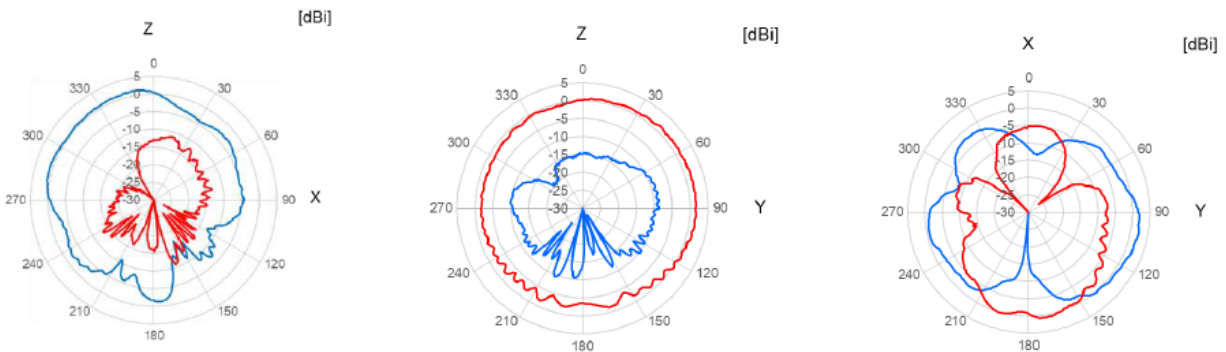

Blue line: Horizontal polarization  
Red line: Vertical polarization

Peak gain of the main polarization component in the ZX, ZY, and XY planes

Frequency [GHz]	Peak gain [dBi]
2.4	1.96
2.5	2.14
5.15	1.97
5.85	2.23
5.925	2.38
7.125	2.35

## 5. Environmental conditions and reliability

5.1. Operating temperature range  
-40 °C to +125 °C

5.2. Storage conditions

IEC 61760-2

Stock temperature range

+5 °C to +40 °C

Relative humidity

10 % to 75 %



## 6. Recommended land pattern and reference board pattern

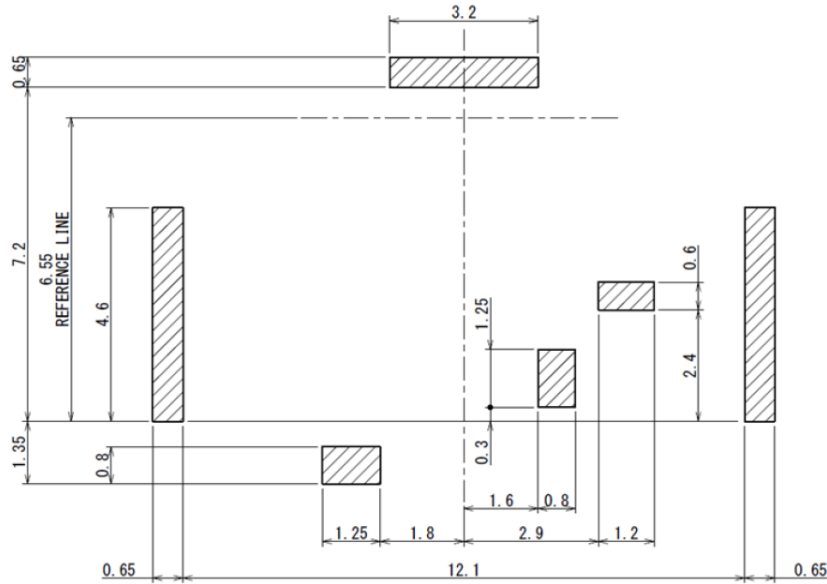

Recommended land pattern

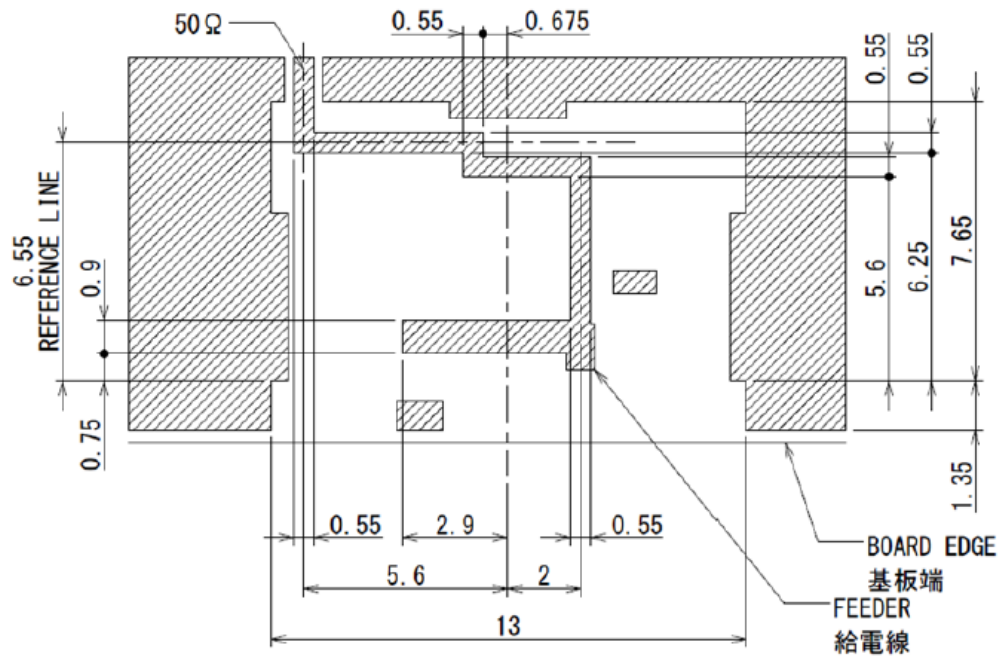

Reference board pattern (board thickness: 1.6 mm)

## 7. Recommended reflow temperature profile

	Temperature	Heating time
Preheating temperature	180 to 200 °C	120 s (max.)
Main heating temperature	Above 220 °C	50 s (max.)
Peak temperature	250 °C (max.)	-

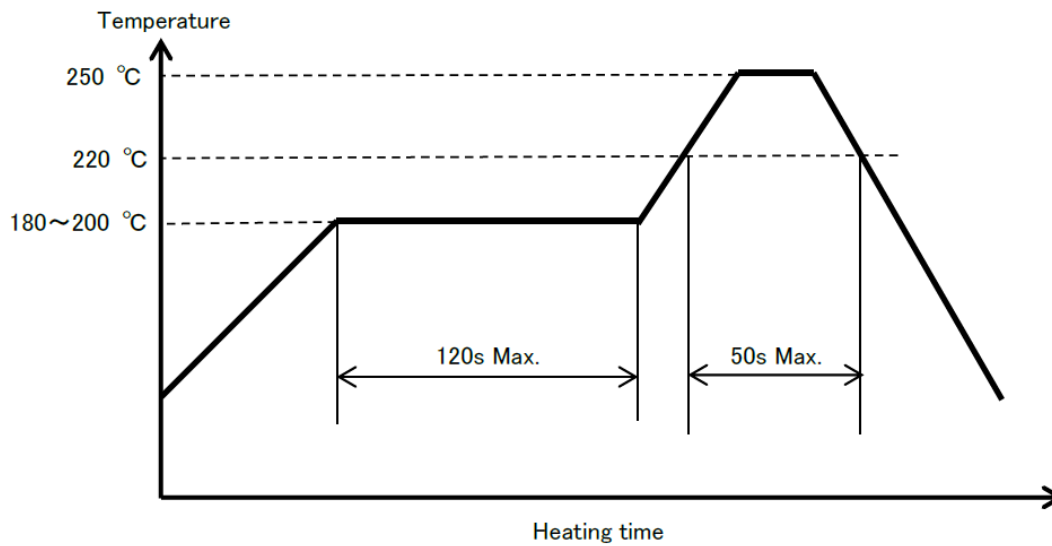



## REVISION HISTORY

Version	Change to current version	Page(s)
RAC002456 Issue A September 30, 2022	Initial datasheet	N/A

[CAUTION]

- All information included in this document is current as of the date this document is issued. Such information, however, is subject to change without any prior notice.
- You should not alter, modify, copy, or otherwise misappropriate any CEL product, whether in whole or in part.
- CEL does not assume any liability for infringement of patents, copyrights, or other intellectual property rights of third parties by or arising from the use of CEL products or technical information described in this document. No license, expressed, implied or otherwise, is granted hereby under any patents, copyrights or other intellectual property rights of CEL or others.
- Descriptions of circuits, software and other related information in this document are provided only to illustrate the operation of semiconductor products and application examples. You are fully responsible for the incorporation of these circuits, software, and information in the design of your equipment. CEL assumes no responsibility for any losses incurred by you or third parties arising from the use of these circuits, software, or information.
- CEL has used reasonable care in preparing the information included in this document, but CEL does not warrant that such information is error free. CEL assumes no liability whatsoever for any damages incurred by you resulting from errors in or omissions from the information included herein.
- Although CEL endeavors to improve the quality and reliability of its products, semiconductor products have specific characteristics such as the occurrence of failure at a certain rate and malfunctions under certain use conditions. Please be sure to implement safety measures to guard them against the possibility of physical injury, and injury or damage caused by fire in the event of the failure of a CEL product, such as safety design for hardware and software including but not limited to redundancy, fire control and malfunction prevention, appropriate treatment for aging degradation or any other appropriate measures  
Because the evaluation of microcomputer software alone is very difficult, please evaluate the safety of the final products or system manufactured by you.
- Please use CEL products in compliance with all applicable laws and regulations that regulate the inclusion or use of controlled substances, including without limitation, the EU RoHS Directive.  
CEL assumes no liability for damages or losses occurring as a result of your noncompliance with applicable laws and regulations.
- This document may not be reproduced or duplicated, in any form, in whole or in part, without prior written consent of CEL.
- Please contact CEL if you have any questions regarding the information contained in this document or CEL products, or if you have any other inquiries.