



Electrical Specifications

Band 1 (Low Band): 1710-1785 MHz
Band 1 Insertion Loss: -3.2 dB Max
Band 1 Ripple: 2.2 dB Max
Band 1 Return Loss @ Port 2: -10 dB Min
Band 1 Return Loss @ Ant: -10 dB Min
Band 1 Attenuation: -40 dB @ 1805-1880 MHz

Band 2 (High Band): 1805-1880 MHz
Band 2 Insertion Loss: -3.0 dB Max
Band 2 Ripple: 2.2 dB Max
Band 2 Return Loss @ Port 3: -10 dB Min
Band 2 Return Loss @ Ant: -10 dB Min
Band 2 Attenuation: -40 dB @ 1710-1785 MHz

Isolation

Rejection @ Low Band: -42 dB @ 1710-1785 MHz
Rejection @ High Band: -42 dB @ 1805-1880 MHz

Power Input (Any Port): 3 Watts Max

Mechanical

Mounting Method: SMT
Dimensions: 24.04 x 7.0 x 4.6 mm

Environmental

Operating Temperature: -40 to +85° C
Storage Temperature: -50 to +95° C

This product is RoHS compliant.

Outline Drawing:

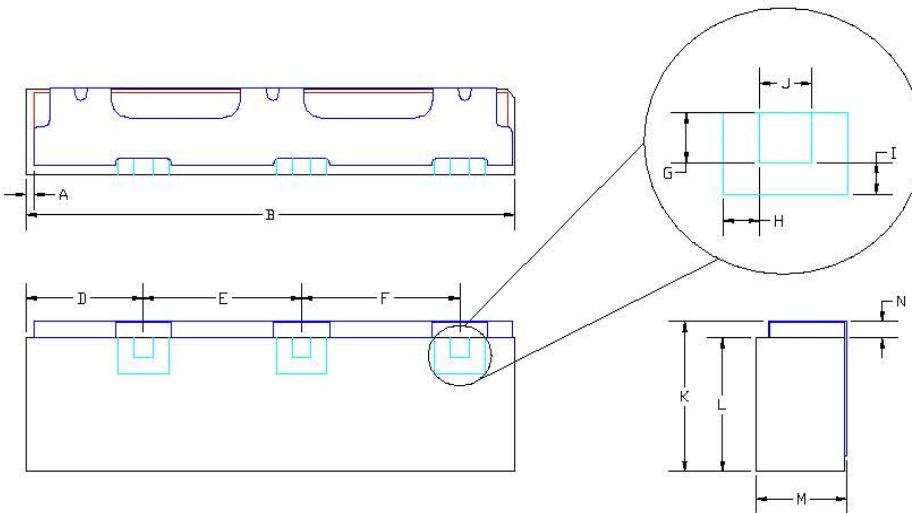

Dim	Nominal (mm)	Tolerance (mm) +/- or max
A	0.25	0.25
B	24.04	max
D	3.05	0.25
E	10.57	0.13
F	7.4	0.13
G	1.02	0.13
H	0.79	0.13
I	0.79	0.13
J	0.89	0.13
K	7.00	max
L	6.00	max
M	4.60	max
N	0.84	0.13



ANATECH ELECTRONICS INC
RF & Microwave Filters & Products

1747.5 / 1842.5 MHz Ceramic Duplexer

Part Number: AM1747-1842D1172



Response Plot:

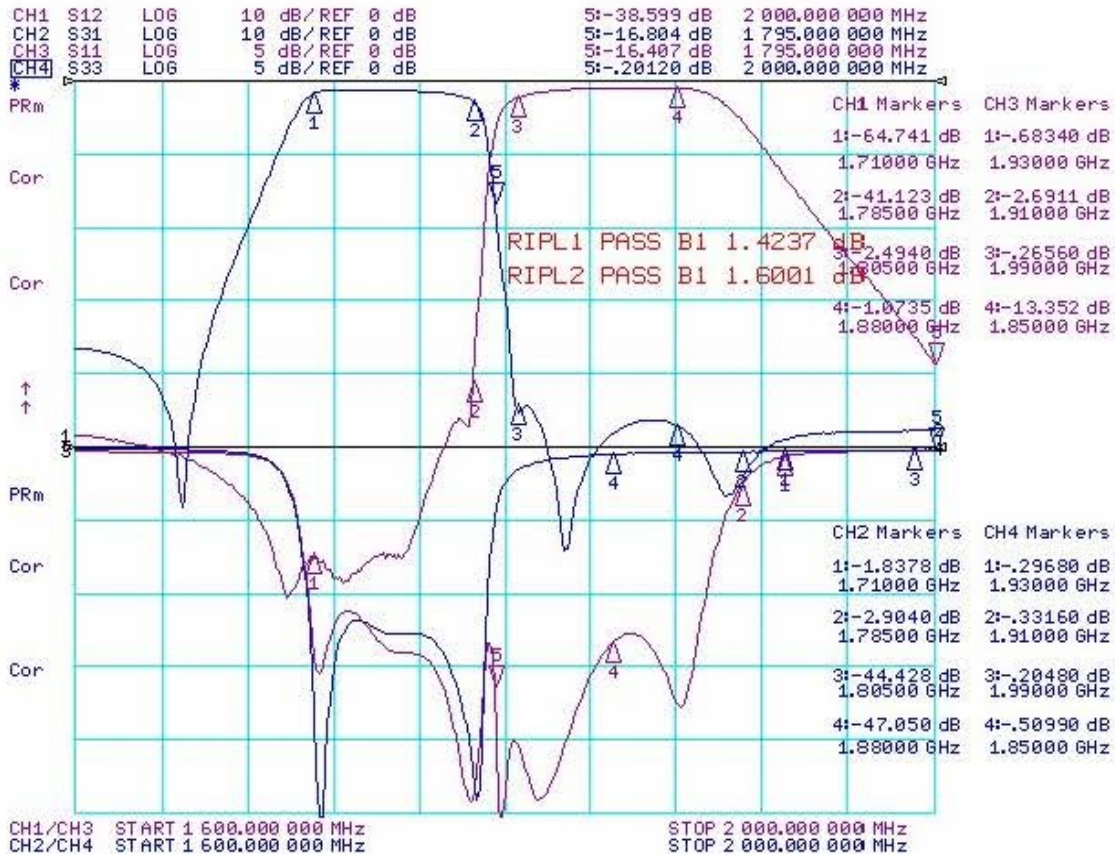

PCB Layout:

