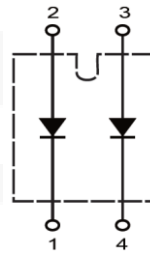

# Schottky Rectifier Module Type 100 A

 $V_{RRM} = 120\text{ V}$ 
 $I_{F(AV)} = 100\text{ A}$ 

## Features

- High Surge Capability
- Type 120 V  $V_{RRM}$
- Isolation Type Package
- Electrically Isolated Base Plate
- Not ESD Sensitive

**SOT-227 Package**

## Maximum ratings

Parameter	Symbol	Conditions	Value	Unit
Maximum recurrent peak reverse voltage	$V_{RRM}$		120	V
Maximum DC blocking voltage	$V_{DC}$		120	V
Maximum RMS Voltage	$V_{RMS}$		84	V
Operating temperature	$T_j$		-40 to 150	°C
Storage temperature	$T_{stg}$		-40 to 150	°C

## Electrical characteristics at 25 °C, unless otherwise specified

Parameter	Symbol	Conditions	Value	Unit
Average forward current (per pkg)	$I_{F(AV)}$	$T_C = 110\text{ °C}$	100	A
Peak forward surge current (per leg)	$I_{FSM}$	8.3 ms, half sine	750	A
Maximum instantaneous forward voltage* (per leg)	$V_F$	$I_{FM} = 50\text{ A}, T_j = 25\text{ °C}$	0.88	V
		$I_{FM} = 50\text{ A}, T_j = 125\text{ °C}$	0.75	V
Maximum instantaneous reverse current at rated DC blocking voltage (per leg)	$I_R$	$T_j = 25\text{ °C}$	3	mA
		$T_j = 100\text{ °C}$	10	mA
		$T_j = 150\text{ °C}$	30	mA
Isolation voltage	$V_{ISO}$	A.C. 1 minute	2500	V

## Thermal characteristics

Maximum thermal resistance junction to case (per leg)	$R_{\theta jc}$		0.80	°C/W
---	-----------------	--	------	------

\* Pulse Test: Pulse width 300  $\mu\text{s}$ , Duty < 2 %

Figure.1 - Typical Forward Characteristics

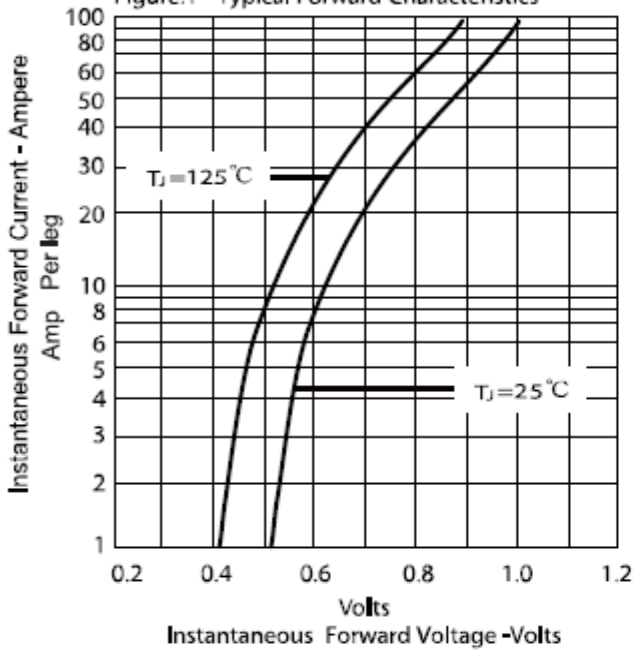

Figure .2- Forward Derating Curve

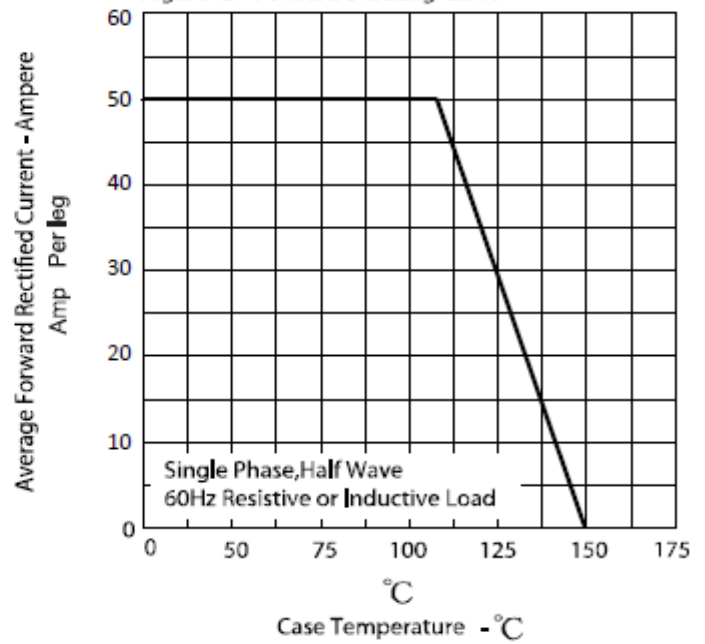

Figure.3 - Peak Forward Surge Current

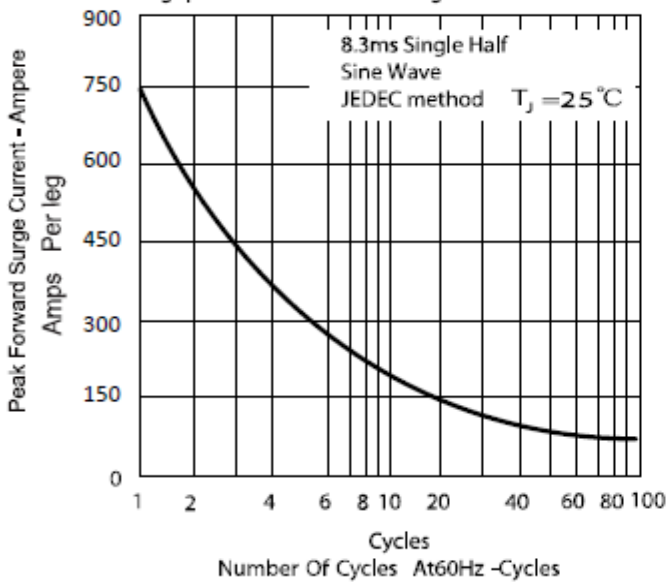
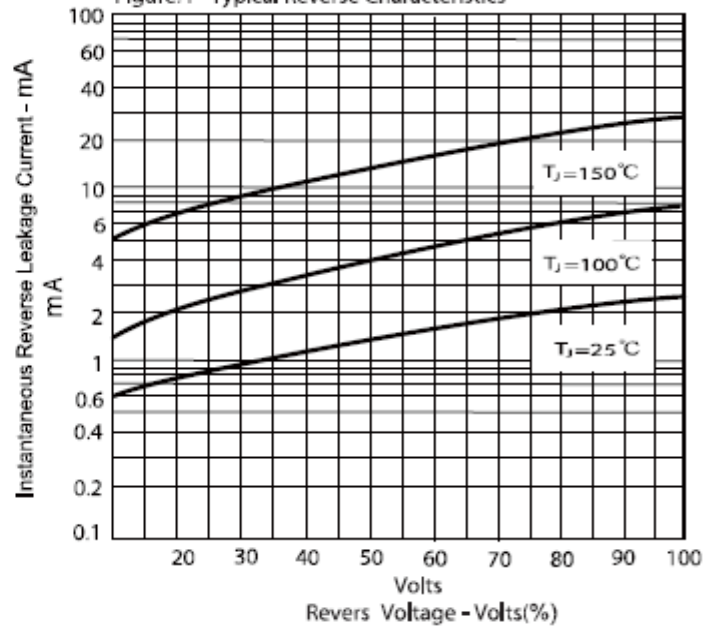
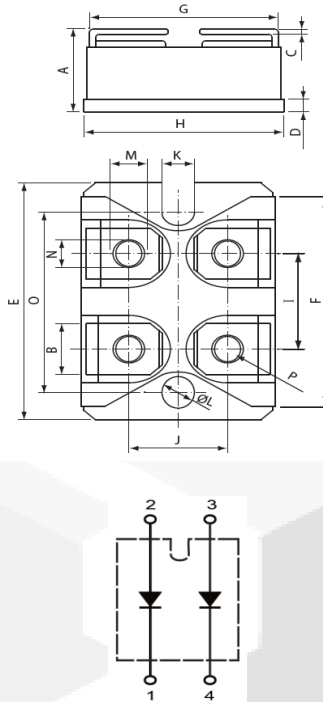

Figure.4 - Typical Reverse Characteristics



**Package dimensions and terminal configuration**

Product is marked with part number and terminal configuration.



DIMENSIONS				
DIM	INCHES		MM	
	MIN	MAX	MIN	MAX
A	.500	.519	12.70	13.20
B	.307	.322	7.80	8.20
C	.029	.033	.75	.84
D	.077	.082	1.95	2.10
E	1.487	1.502	37.80	38.20
F	1.250	1.258	31.75	32.00
G	.931	.956	23.65	24.30
H	.996	1.007	25.30	25.60
I	.586	.594	14.90	15.10
J	.492	.516	12.50	13.10
K	.161	.169	4.10	4.30
L	.161	.169	4.10	4.30
M	.181	.191	4.60	4.95
N	.165	.177	4.20	4.50
O	1.184	1.192	30.10	30.30
P	M4*8			