



MAX13331 Evaluation Kit

General Description

The MAX13331 evaluation kit (EV kit) is a fully assembled and tested surface-mount circuit board that evaluates the MAX13331 DirectDrive® stereo headphone amplifier. DirectDrive eliminates the two large DC-blocking capacitors typically required between the output of the amplifier and the headphones. The MAX13331 EV kit includes two RCA phono jacks on the input and a 3.5mm headphone jack on the output to facilitate easy connections to the circuit board.

The MAX13331 EV kit can also evaluate the MAX13330 IC. This requires the IC replacement of U1.

Features

- ◆ No DC-Blocking Capacitors Required
- ◆ 4V to 5.5V Single-Supply Operation
- ◆ Adjustable Gain (MAX13331 Only)
- ◆ 125mW Per Channel into 32Ω at 0.01% THD+N
- ◆ Shutdown Control
- ◆ Ultra-Compact Solution
- ◆ Low-Profile (1.2mm, max) Design
- ◆ Lead(Pb)-Free and RoHS Compliant
- ◆ Fully Assembled and Tested Surface-Mount Board

Ordering Information

PART	TYPE
MAX13331EVKIT+	EV Kit

+Denotes lead(Pb)-free and RoHS compliant.

DirectDrive is a registered trademark of Maxim Integrated Products, Inc.

Component List

DESIGNATION	QTY	DESCRIPTION
C1, C2	2	1μF ±10%, 16V X7R ceramic capacitors (0603) Murata GRM188R71C105K TDK C1608X7R1C105K
C3, C4, C11	3	1000pF ±10%, 50V X7R ceramic capacitors (0402) Murata GRM155R71H102K TDK C1005X7R1H102K
C5, C7, C8	3	1μF ±10%, 10V X7R ceramic capacitors (0603) Murata GRM188R71A105K TDK C1608X7R1A105K
C6, C9, C14	3	0.1μF ±10%, 16V X7R ceramic capacitors (0402) Murata GRM155R71C104K TDK C1005X7R1C104K
C10	1	10μF ±10%, 10V X7R ceramic capacitor (0805) Murata GRM21BR71A106K
C12, C13	2	0.01μF ±10%, 50V X7R ceramic capacitors (0402) Murata GRM155R71H103K

DESIGNATION	QTY	DESCRIPTION
J1	1	3.5mm stereo headphone jack
JU1	1	2-pin header, 0.1in centers
JU2	0	Not installed, 2-pin header, 0.1in centers
OUTL, OUTR, SGND	0	Not installed, miniature test points
P1	1	RCA phono jack (side-entry PCB mount), white
P2	1	RCA phono jack (side-entry PCB mount), red
R1, R2, R5	3	15kΩ ±1% resistors (0402)
R3, R4	2	22.6kΩ ±1% resistors (0402)
U1	1	Automotive DirectDrive headphone amplifier (16 QSOP) Maxim MAX13331GEE/V+
—	1	Shunt
—	1	PCB: MAX13331 EVALUATION KIT+

Evaluates: MAX13330/MAX13331



MAX13331 Evaluation Kit

Component Suppliers

SUPPLIER	PHONE	WEBSITE
Murata Electronics North America, Inc.	770-436-1300	www.murata-northamerica.com
TDK Corp.	847-803-6100	www.component.tdk.com

Note: Indicate that you are using the MAX13331 when contacting these component suppliers.

Quick Start

Required Equipment

- One pair of 8Ω to 32Ω headphones
- One variable DC power supply capable of supplying between 4V and 5.5V at 500mA
- One stereo audio source

Procedure

The MAX13331 EV kit is fully assembled and tested. Follow the steps below to verify board operation.

Caution: Do not turn on the power supply until all connections are completed.

- 1) Plug the headphones into the 3.5mm headphone jack (J1).
- 2) Ensure that the stereo audio source is turned off.
- 3) Connect the disabled stereo audio source through the RCA phono jacks (P1 and P2).
- 4) Ensure that a shunt is installed on jumper JU1.
- 5) Connect the 4V to 5.5V DC power supply to the VDD and PGND pads.
- 6) Turn on the DC power supply.
- 7) Verify that the audio source level is low.
- 8) Enable the stereo audio source.
- 9) Verify that the audio source signal is clearly heard from the headphones.

Detailed Description of Hardware

The MAX13331 EV kit is a stereo, single-supply headphone amplifier. The input impedance is 15kΩ. The -3dB corner frequencies are approximately 10Hz and greater than 22kHz and are dependent on components R1/C1 and R2/C2. The MAX13331 EV kit has a gain of approximately 1.5 and can be powered with a 4V to 5.5V supply.

The EV kit provides two RCA phono jacks (P1 and P2) to facilitate the connection of an audio source. In addition, both outputs (OUTL and OUTF) are routed to a stereo headphone jack (J1), facilitating output monitoring. Shutdown control of OUTL and OUTF is also provided through jumper JU1.

Shutdown Control

The MAX13331 EV kit provides jumper JU1 to disable the outputs, OUTL and OUTF (see Table 1 for shutdown shunt positions). Both OUTL and OUTF are routed to the headphone jack (J1).

Layout Considerations

To optimize the audio performance of the MAX13331, it is important to follow these layout guidelines. The MAX13331 EV kit uses two ground planes to minimize switching noise. The two planes are star-connected at one point (JU2 pad). Capacitors C5, C6, C8, C12, C13, and C14 should be placed close to the IC. Refer to the MAX13331 IC data sheet for additional layout considerations.

The MAX13331 EV kit is a four-layer design, but it is possible to design the MAX13331 circuit on to a two-layer board. For a two-layer design, optimize the signal and power ground planes by maximizing the area and connecting each plane, as close as possible, to its respective IC pin.

Table 1. Jumper JU1 Function

SHUNT POSITION	DESCRIPTION
Installed	Outputs enabled
Not installed	Outputs disabled

MAX1331 Evaluation Kit

Evaluates: MAX13330/MAX13331

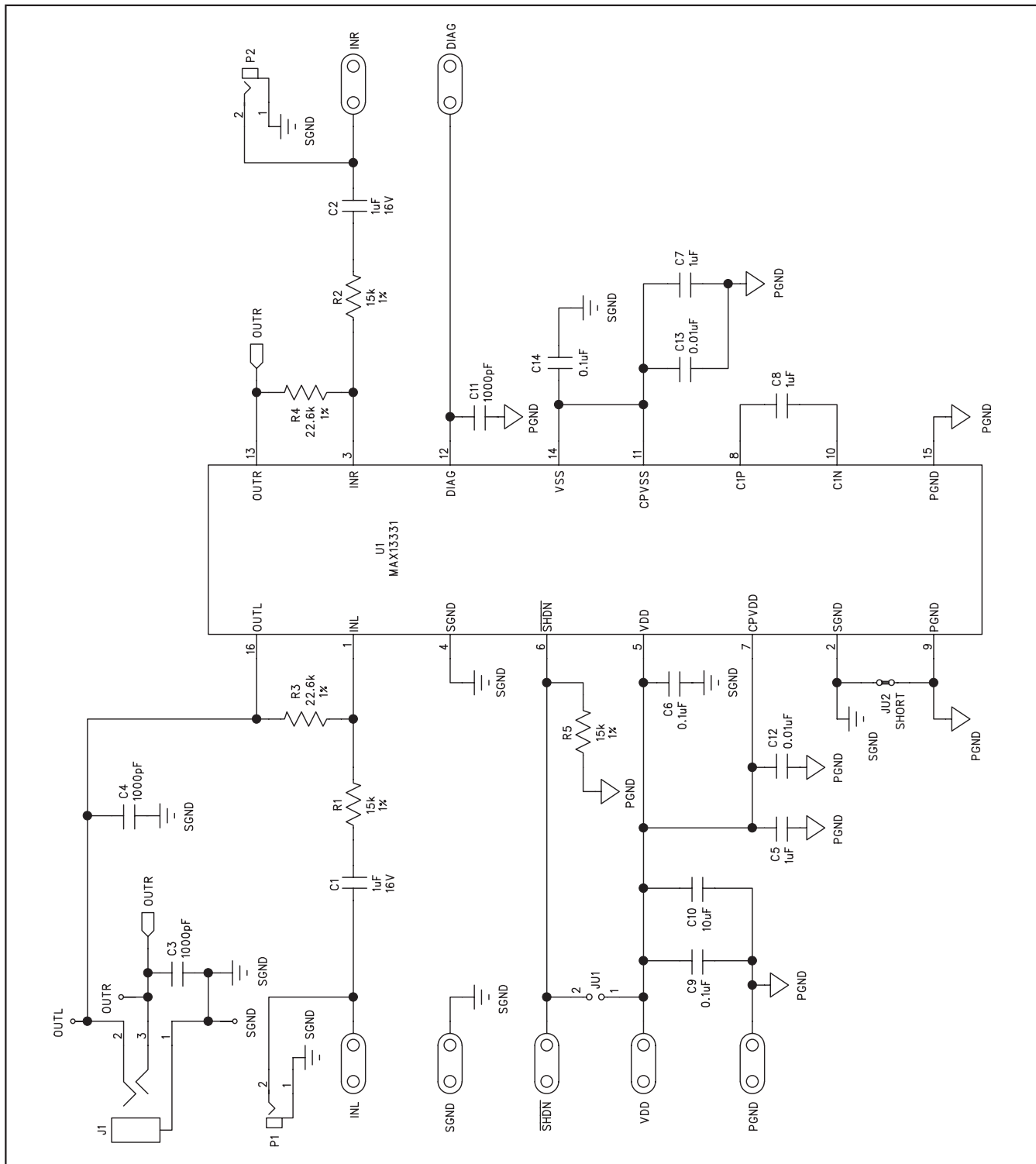

Figure 1. MAX13331 EV Kit Schematic

MAX13331 Evaluation Kit

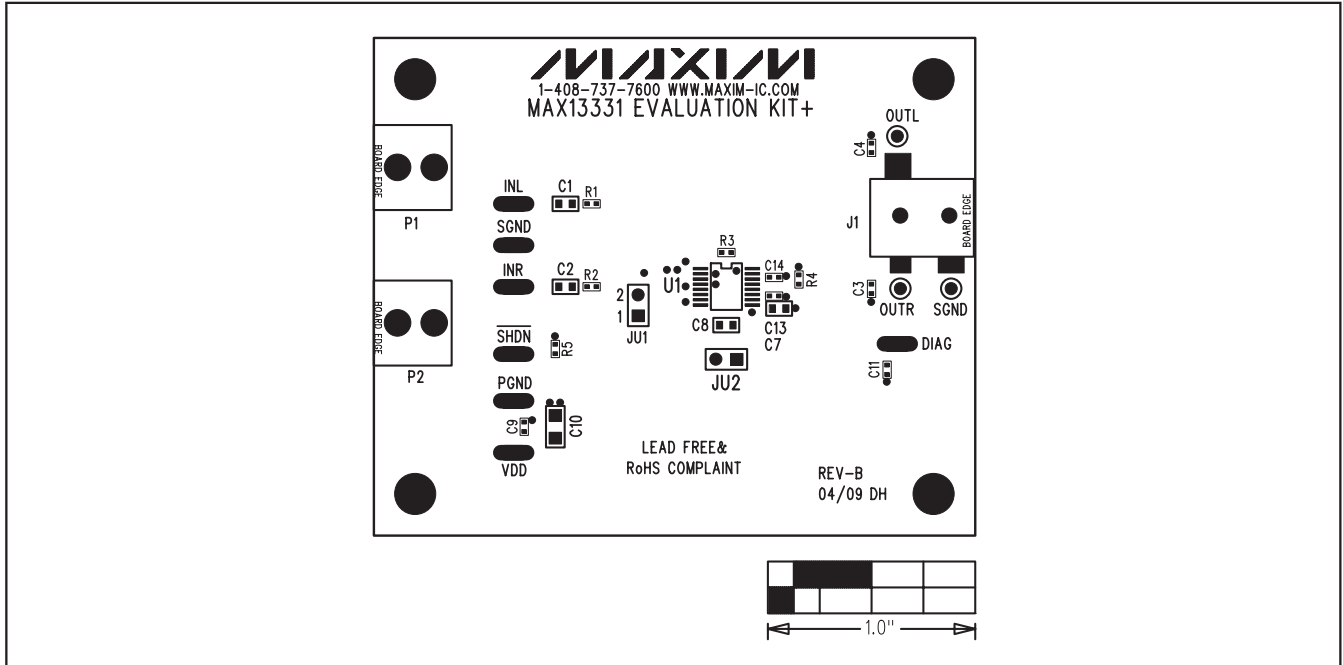

Figure 2. MAX13331 EV Kit Component Placement Guide—Component Side

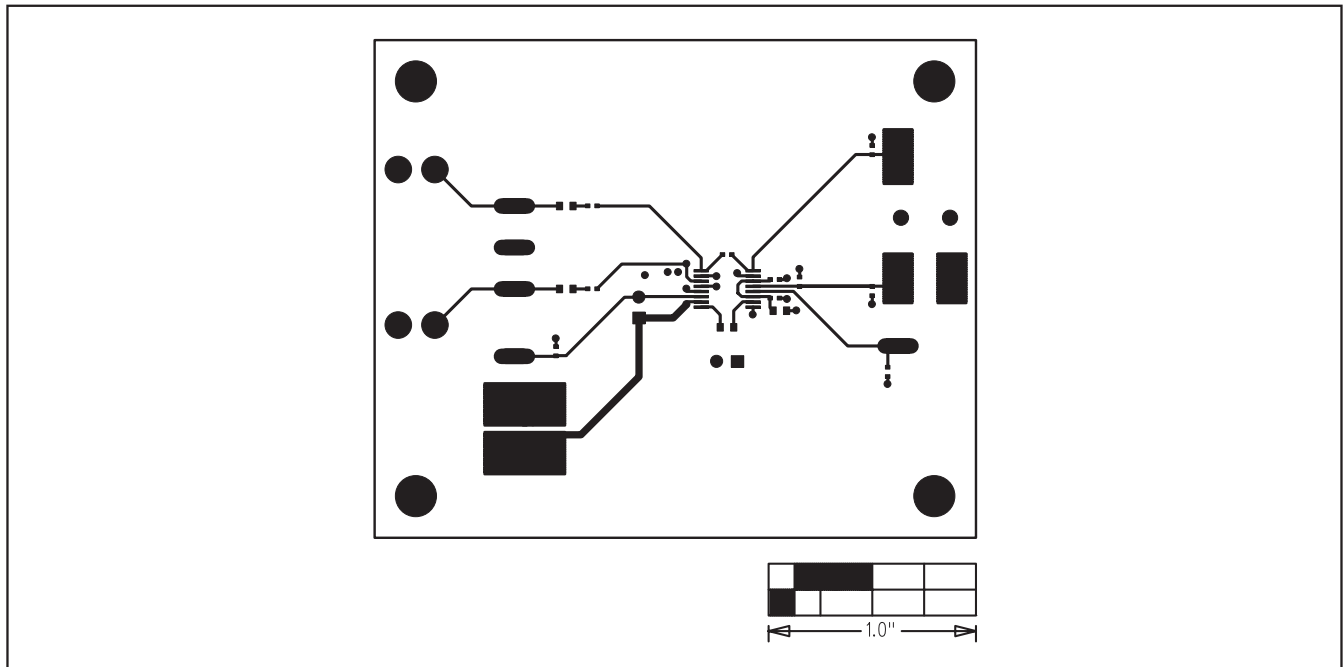

Figure 3. MAX13331 EV Kit PCB Layout—Component Side

MAX13331 Evaluation Kit

Evaluates: MAX13330/MAX13331

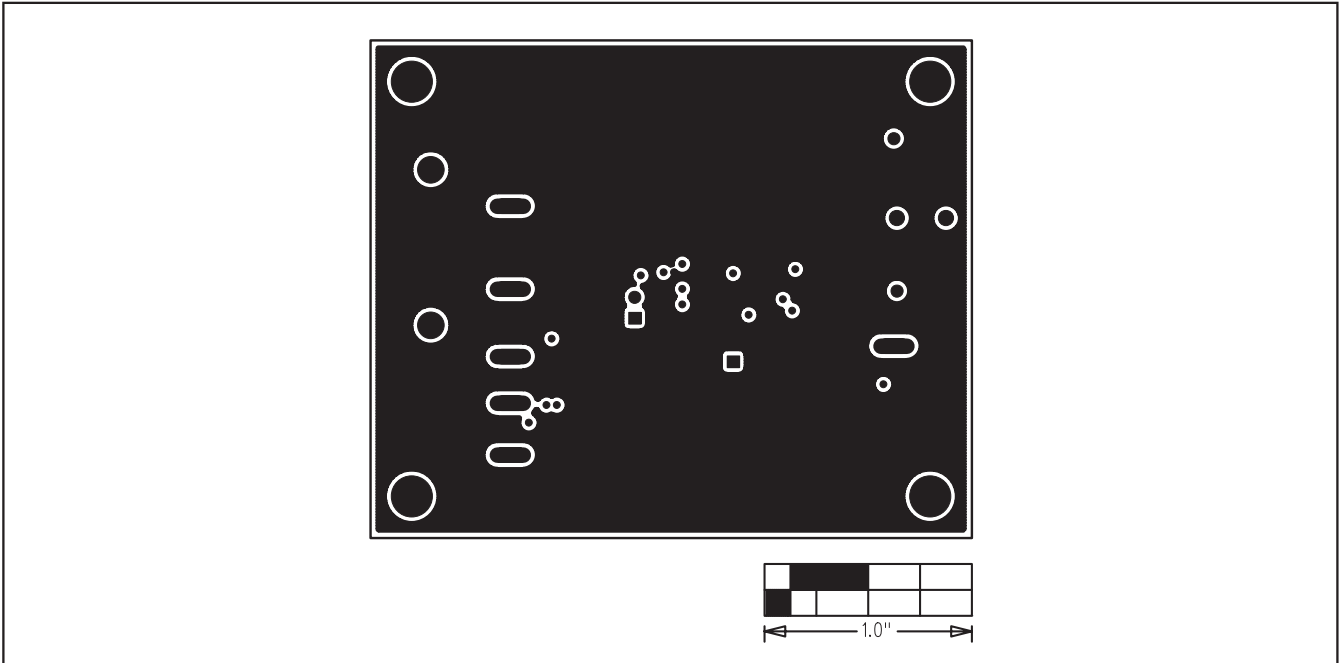

Figure 4. MAX13331 EV Kit PCB Layout—Internal Layer 2

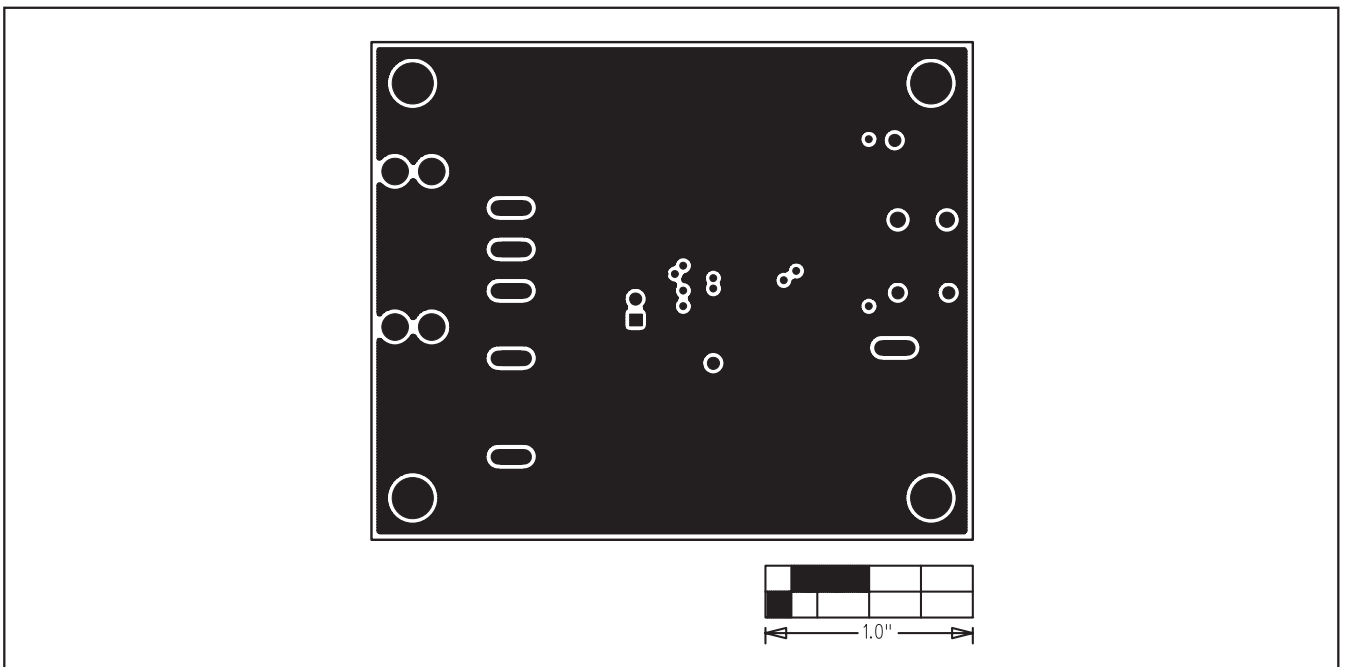

Figure 5. MAX13331 EV Kit PCB Layout—Internal Layer 3

MAX13331 Evaluation Kit

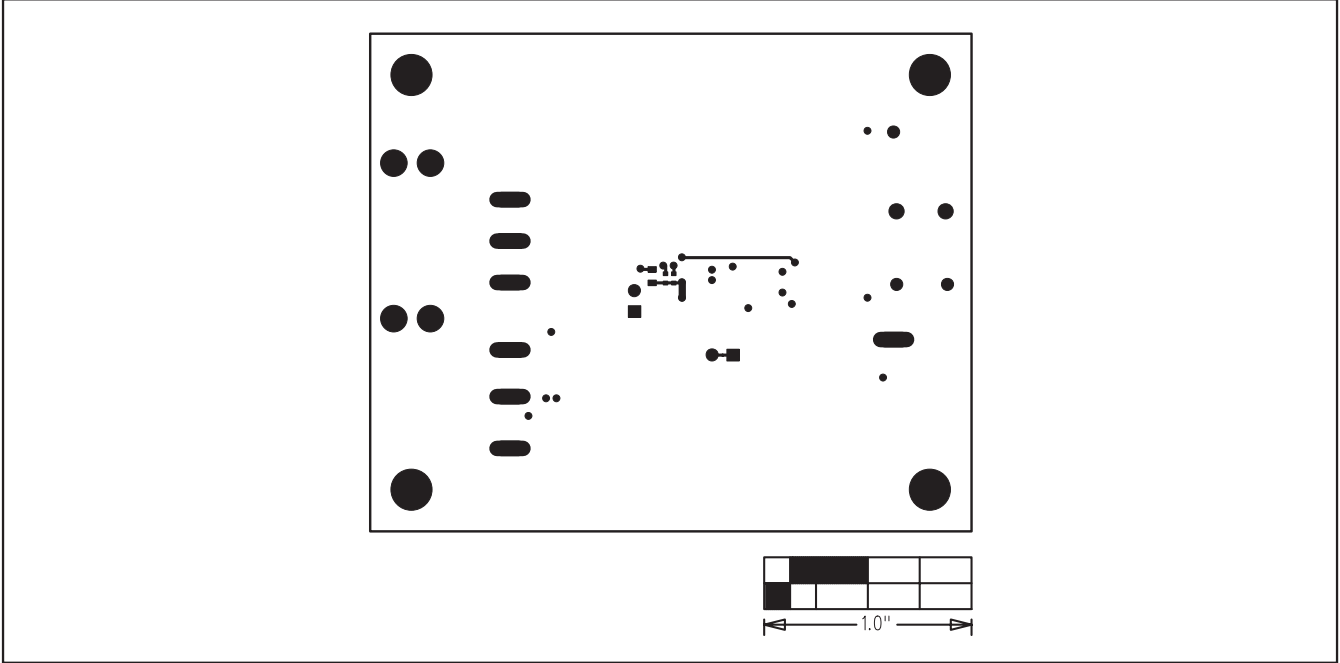

Figure 6. MAX13331 EV Kit PCB Layout—Solder Side

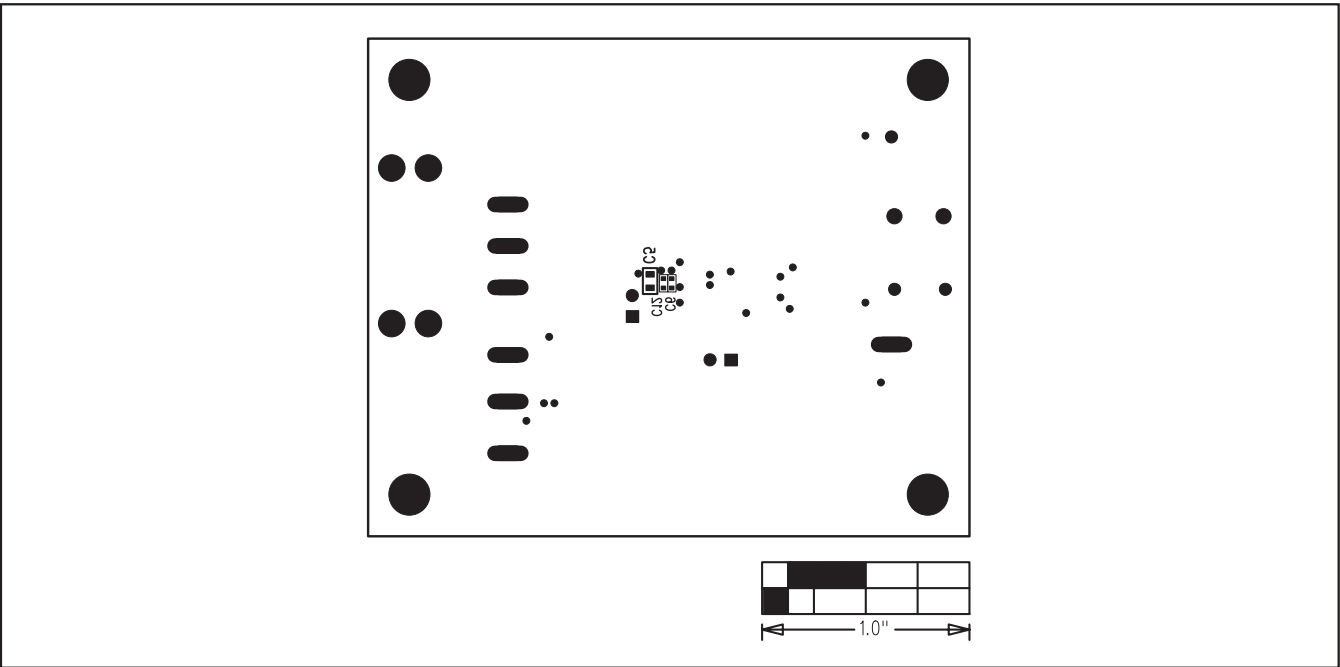

Figure 7. MAX13331 EV Kit Component Placement Guide—Solder Side

MAX13331 Evaluation Kit

Revision History

REVISION NUMBER	REVISION DATE	DESCRIPTION	PAGES CHANGED
0	3/09	Initial release	—
1	4/09	Updated schematic and PCB layout diagrams with routing changes on jacks P1 and P2	3-6

Evaluates: MAX13330/MAX13331

Maxim cannot assume responsibility for use of any circuitry other than circuitry entirely embodied in a Maxim product. No circuit patent licenses are implied. Maxim reserves the right to change the circuitry and specifications without notice at any time.

Maxim Integrated Products, 120 San Gabriel Drive, Sunnyvale, CA 94086 408-737-7600 _____ 7