

eGuard0504F Low Voltage TVS Diode Array

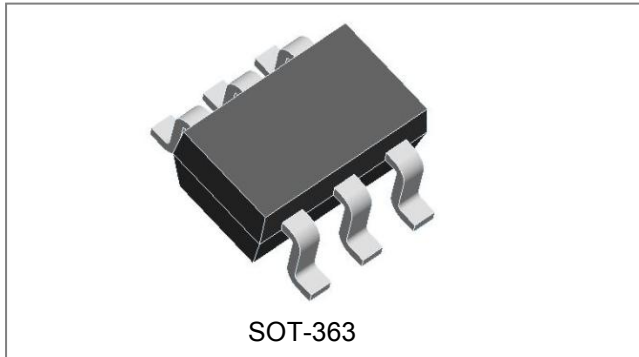

Circuit Diagram

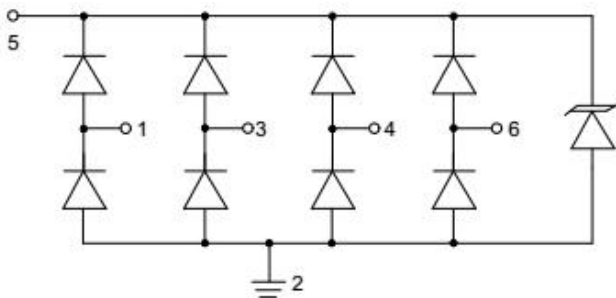

Applications

- USB 2.0
- USB OTG
- Monitors and Flat Panel Displays
- Digital Visual Interface(DVI)
- High Definition Multimedia Interface(HDMI)
- Gigabit Ethernet
- SIM Ports
- IEEE 1394 Firewire Ports

Description

The eGuard0504F TVS diode is a low capacitance TVS(Transient Voltage Suppressor) device designed to protect sensitive components which are connected to data and transmission lines from overvoltage caused by transients electrostatic discharge(ESD), cable discharge events(CDE), and electrical fast transients(EFT). The eGuard0504F integrates low capacitance steering diode and a TVS diode in one single die. During transient conditions, the steering diodes direct the transient to either the positive side of the power supply line or to ground. The internal TVS diode prevents over-voltage on the power line to protect any downstream components.

This low capacitance array device allows the users to protect four high-speed data or transmission lines. The low inductance construction minimizes voltage overshoot during high current surges.

Features

- Transient protection for high-speed data lines
IEC 61000-4-2(ESD)±15KV(air),±8KV(contact)
IEC 61000-4-4(EFT) 40A (5/50ns)
- Array of surge rated diodes with internal TVS Diode
- Small package (2.4*2.2mm) saves board space
- Protects up to four I/O lines & power line
- Low capacitance(<3pF) for high-speed interface
- No insertion loss to 2.0GHz
- Low leakage current and clamping voltages
- Low operating voltage(5V)

Mechanical Characteristics

- SOT-363 package
- ROHS/WEEE Compliant
- Molding compound flammability rating: UL 94V-0
- Marking: F54
- Packaging: Tape and Reel

Maximum Ratings

Characteristics	Symbol	Max.	Units
Peak Pulse Power (tp=8/20us)	P _{PK}	150	Watts
Peak Pulse Current (tp=8/20us)	I _{PP}	6	A
ESD per IEC61000-4-2 (air)	V _{ESD}	15	KV
ESD per IEC61000-4-2 (contact)		8	
Operating Temperature	T _J	-55 to +125	°C
Storage Temperature	T _{STG}	-55 to +150	°C

Electrical Characteristics

Characteristics	Symbol	Condition	Min.	Typ.	Max.	Units
Reverse Stand-Off Voltage	V _{RWM}				5	V
Reverse Breakdown Voltage	V _{BR}	I _t =1mA Pin 5 to 2	6			V
Reverse Leakage Current	I _R	V _{RWM} =5V, T=25°C Pin 5 to 2			3	uA
Clamping Voltage	V _C	I _{PP} =1A, tp=8/20us Any pin to pin2			15	V
Clamping Voltage	V _C	I _{PP} =6A, tp=8/20us Any pin to pin2			25	V
Junction Capacitance	C _j	V _R =0V, f=1MHz Any I/O pin to pin2			3	pF
		V _R =0V, f=1MHz Between I/O pins			1.5	pF

Note: I/O pins are pin 1, 3, 4, and 6

Ratings and Characteristics Curves

Non-Repetitive Peak Pulse Power vs. Pulse Time

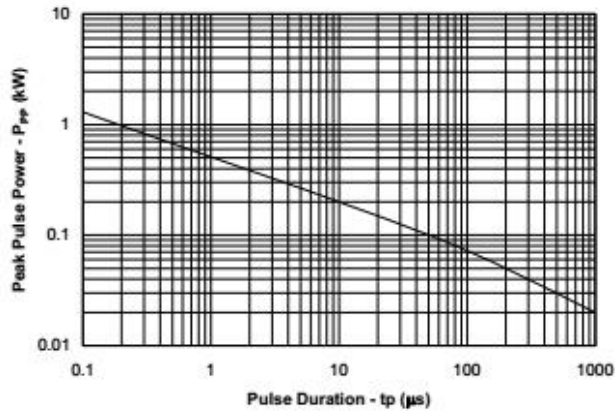

Power Derating Curve

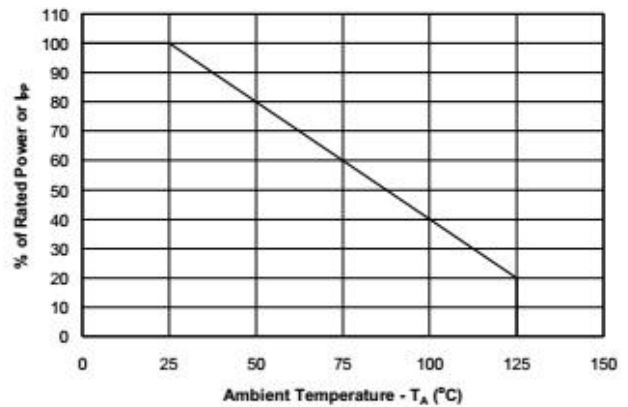

Pulse Waveform

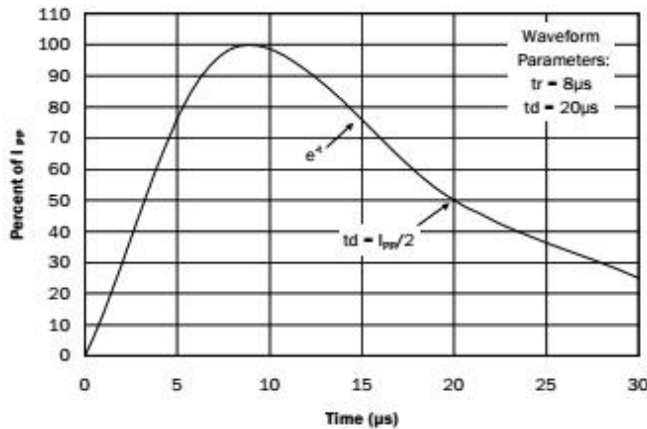

Clamping Voltage vs. Peak Pulse Current

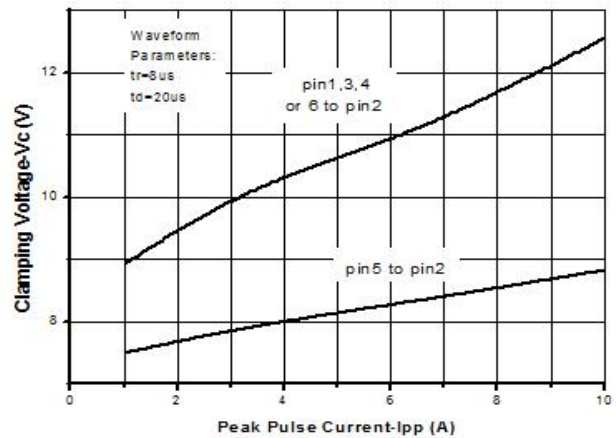

Forward Voltage vs. Peak Pulse Current

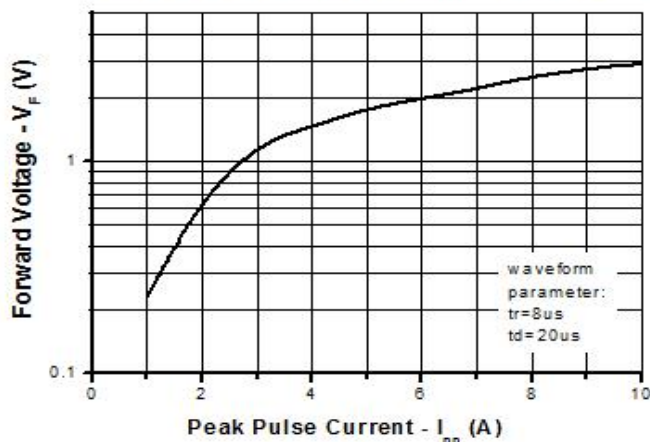

Capacitance vs. Reverse Voltage (Normalized to 0V)

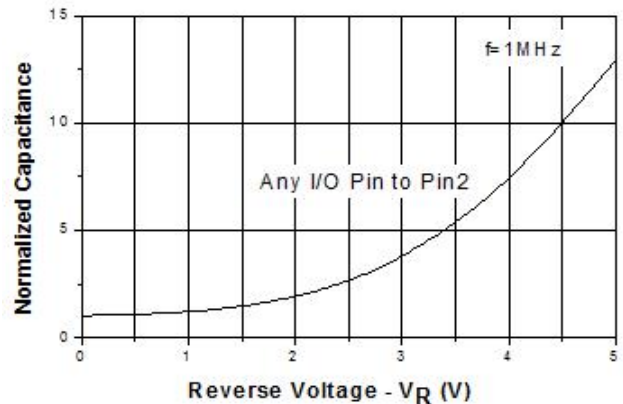

Mechanical Dimensions

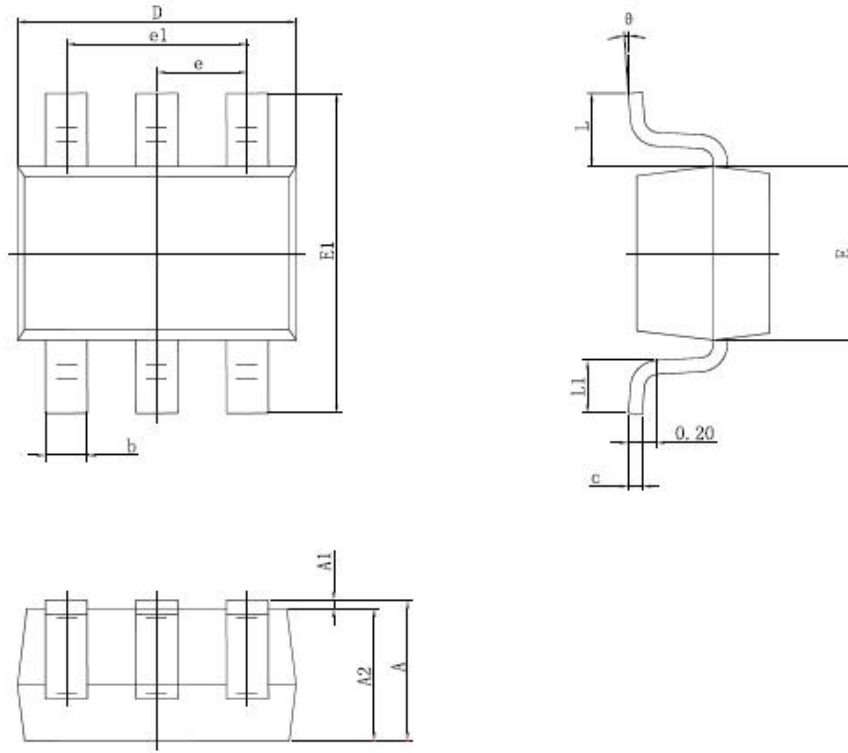

Symbol	Dimensions In Millimeters		Dimensions In Inches	
	Min.	Max.	Min.	Max.
A	0.900	1.100	0.035	0.043
A1	0.000	0.100	0.000	0.004
A2	0.900	1.000	0.035	0.039
b	0.150	0.350	0.006	0.014
c	0.080	0.150	0.003	0.006
D	2.000	2.200	0.079	0.087
E	1.150	1.350	0.045	0.053
E1	2.150	2.450	0.085	0.096
e	0.650 TYP.		0.026 TYP.	
e1	1.200	1.400	0.047	0.055
L	0.525 REF.		0.021 REF.	
L1	0.260	0.460	0.010	0.018
θ	0°	8°	0°	8°

Circuit Diagram

The eGuard0504F TVS diode is designed to protect data lines by clamping them to a fixed reference. When the voltage on the protected line exceeds the reference voltage the steering diodes are forward biased, conducting the transient current away from the sensitive circuitry.

Data lines are connected at pins 1,3,4 and 6. Pin2 should be connected to a ground plane. The positive reference is connected at pin5. Pin5 can be connected to the positive supply rail(Vcc) or not connected according to the different reference.

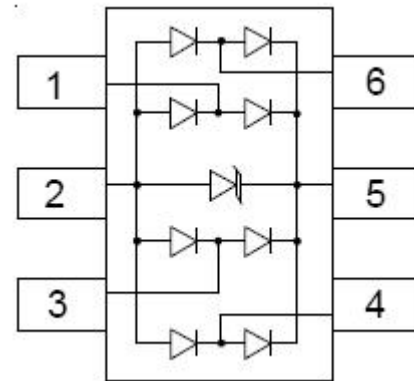

Marking Diagram

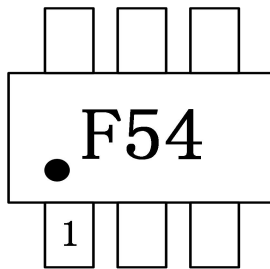

Ordering Information

Device	Package	Shipping
eGuard0504F	SOT-363	3000 pcs/reel

For information on tape and reel specifications, including part orientation and tape sizes, please refer to our tape and reel packaging specification.

Carrier Tape Specification

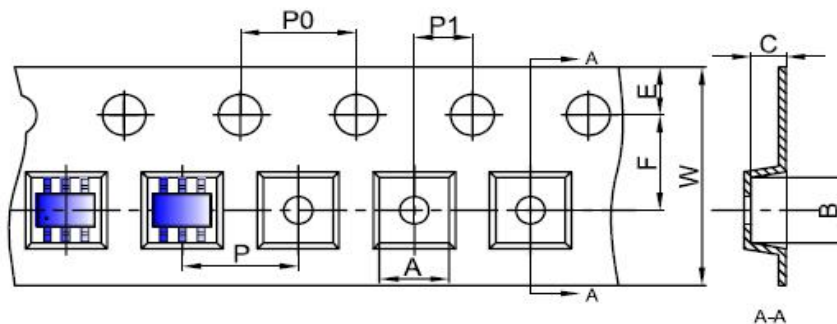

Dimensions are in millimeter										
Pkg type	A	B	C	d	E	F	P0	P	P1	W
SOT-363	2.25	2.55	1.20	Ø1.50	1.75	3.50	4.00	4.00	2.00	8.00
(Tolerance)	+/-0,05	+/-0,05	+/-0,05	+/-0,1	+/-0,1	+/-0,1	+/-0,1	+/-0,1	+/-0,1	+0,3/-0,1



DISCLAIMER:

1- The information given herein, including the specifications and dimensions, is subject to change without prior notice to improve product characteristics. Before ordering, purchasers are advised to contact the SMC Diode Solutions sales department for the latest version of the datasheet(s).

2- In cases where extremely high reliability is required (such as use in nuclear power control, aerospace and aviation, traffic equipment, medical equipment, and safety equipment), safety should be ensured by using semiconductor devices that feature assured safety or by means of users' fail-safe precautions or other arrangement.

3- In no event shall SMC Diode Solutions be liable for any damages that may result from an accident or any other cause during operation of the user's units according to the datasheet(s). SMC Diode Solution assumes no responsibility for any intellectual property claims or any other problems that may result from applications of information, products or circuits described in the datasheets.

4- In no event shall SMC Diode Solutions be liable for any failure in a semiconductor device or any secondary damage resulting from use at a value exceeding the absolute maximum rating.

5- No license is granted by the datasheet(s) under any patents or other rights of any third party or SMC Diode Solutions.

6- The datasheet(s) may not be reproduced or duplicated, in any form, in whole or part, without the expressed written permission of SMC Diode Solutions.

7- The products (technologies) described in the datasheet(s) are not to be provided to any party whose purpose in their application will hinder maintenance of international peace and safety nor are they to be applied to that purpose by their direct purchasers or any third party. When exporting these products (technologies), the necessary procedures are to be taken in accordance with related laws and regulations..