

TAS5142DDV6EVM2

This user's guide describes the operation of the evaluation module for the TAS5142 digital amplifier power output stage using the TAS5086 digital audio PWM processor from Texas Instruments. The user's guide also provides measurement data and design information, including schematic, BOM, and PCB layout.

Contents

1	Overview	2
2	Quick Setup Guide.....	6
3	Protection	9
4	TAS5142DDV6EVM2 Performance.....	10
5	Related Documentation from Texas Instruments	16
Appendix A Design Documents		17

List of Figures

1	Integrated PurePath Digital Amplifier System.....	4
2	Physical Structure for the TAS5142DDV6EVM2 (Approximate Layout).....	5
3	TAS5086 GUI Window	7
4	THD+N vs Power (4 Ω).....	11
5	THD+N vs Power (6 Ω).....	11
6	THD+N vs Power (8 Ω).....	12
7	THD+N vs Frequency (4 Ω).....	12
8	THD+N vs Frequency (6 Ω).....	12
9	THD+N vs Frequency (8 Ω).....	12
10	FFT Spectrum With -60 dBFS Tone	13
11	Idle Noise FFT Spectrum.....	13
12	Channel Separation	13
13	Frequency Response	13
14	High Current Protection	14
15	Pop/Click	14
16	Output Stage Efficiency	15
A-1	TAS5142DDV6EVM2 Schematic (Sheet 1 of 7)	17
A-2	TAS5142DDV6EVM2 Schematic (Sheet 2 of 7)	18
A-3	TAS5142DDV6EVM2 Schematic (Sheet 3 of 7)	19
A-4	TAS5142DDV6EVM2 Schematic (Sheet 4 of 7)	20
A-5	TAS5142DDV6EVM2 Schematic (Sheet 5 of 7)	21
A-6	TAS5142DDV6EVM2 Schematic (Sheet 6 of 7)	22
A-7	TAS5142DDV6EVM2 Schematic (Sheet 7 of 7)	22
A-8	Component Layout	26
A-9	Solder Side	27
A-10	Component Side.....	28
A-11	Component Placement	29
A-12	Silkscreen	30
A-13	Heat Sink	31

PurePath Digital, Equibit are trademarks of Texas Instruments.
 Pozidriv is a trademark of American Screw Company.
 Windows is a trademark of Microsoft Corporation.
 All other trademarks are the property of their respective owners.

A-14	Engineering Change Order	32
------	--------------------------------	----

List of Tables

1	TAS5142DDV6EVM2 Specification	2
2	Recommended Supply Voltages.....	6
3	TAS5142 Warning/Error Signal Decoding.....	9
4	General Test Conditions.....	10
5	TAS5086 Register Settings	10
6	Electrical Data	10
7	Audio Performance.....	11
8	Thermal Specification.....	11
9	Physical Specifications	11
A-1	Parts List	23

1 Overview

The TAS5142DDV6EVM2 PurePath Digital™ customer evaluation module demonstrates the integrated circuits TAS5142DDV and TAS5086DBT from Texas Instruments (TI).

The TAS5142DDV is a high-performance, integrated stereo digital amplifier power stage designed to drive 4-Ω speakers at up to 100 W per channel. The device incorporates TI's Equibit™ technology and is designed to be used with TI's Equibit modulators. This system requires only a simple passive demodulation filter to deliver high-quality, high-efficiency audio amplification.

TAS5086DBT is a high-performance 32-bit (24-bit input) multichannel PurePath Digital pulse width modulator (PWM) based on Equibit technology with a new, fully symmetrical AD modulation scheme.

This EVM is configured with 6 BTL channels.

This EVM, together with a TI input-USB board, is a complete 5.1-channel digital audio amplifier system that includes digital input (S/PDIF), analog inputs, interface to PC, and DAP features like digital volume control, input and output multiplexers.

Table 1. TAS5142DDV6EVM2 Specification

Key Parameters	Values
Output stage supply voltage	0 V–32 V
System supply voltage	15 V–20 V
Number of channels	6 × BTL
Load impedance	4 Ω–8 Ω
Output power	100 W/4 Ω, 10 % THD+N
Dynamic range	>105 dB
PWM processor	TAS5086DBT
Output stage	TAS5142DDV

This 5.1 system is designed for home theater applications such as A/V receivers, DVD receivers, DVD mini-component systems, or home theater in a box (HTIB).

This document covers EVM specifications, audio performance, power efficiency measurement graphs, and design documentation that includes schematics, parts list, layout, and mechanical design.

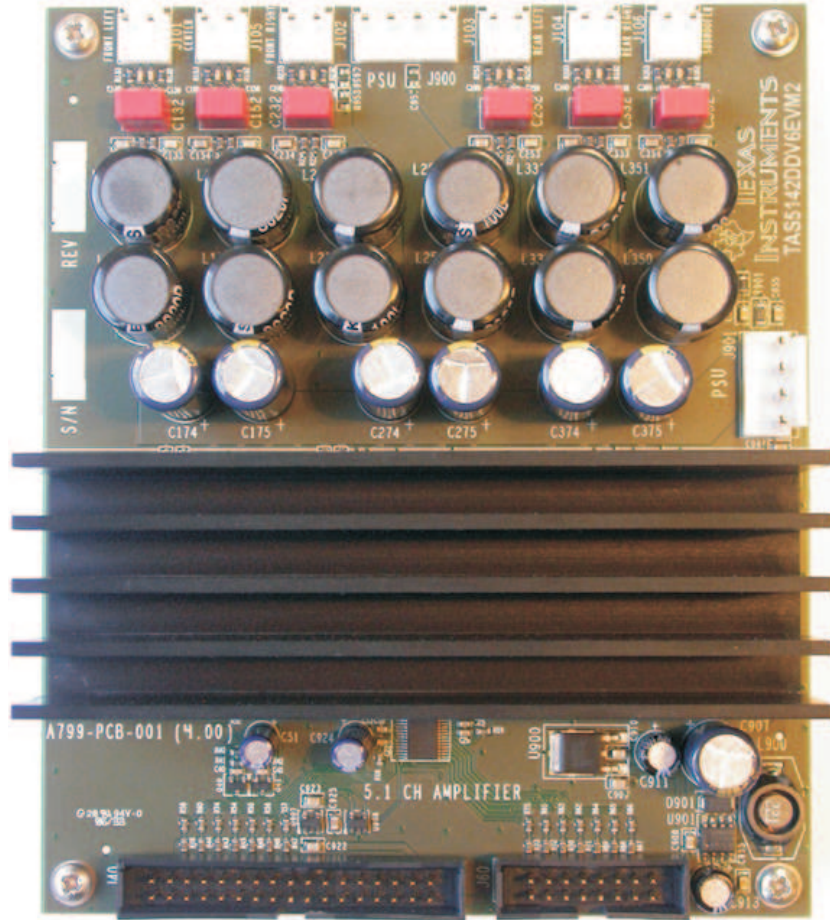

J001

The EVM is delivered with cables and input-USB board to connect to an input source and be controlled from a PC.

1.1 **TAS5142DDV6EVM2 Features**

- 6-channel PurePath Digital evaluation module
- Self-contained protection system (short-circuit and thermal)
- Standard I²S and I²C/control connector for TI input board
- Double-sided plated-through PCB layout

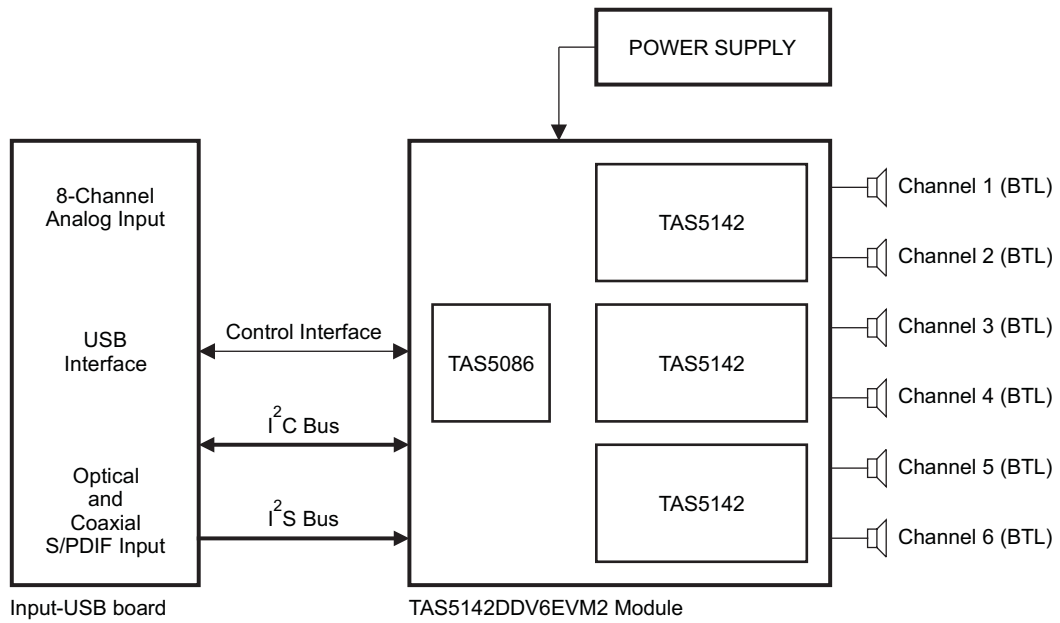

B0228-01

Figure 1. Integrated PurePath Digital Amplifier System

1.2 PCB Key Map

Physical structure for the TAS5142DDV6EVM2 is illustrated in [Figure 2](#).

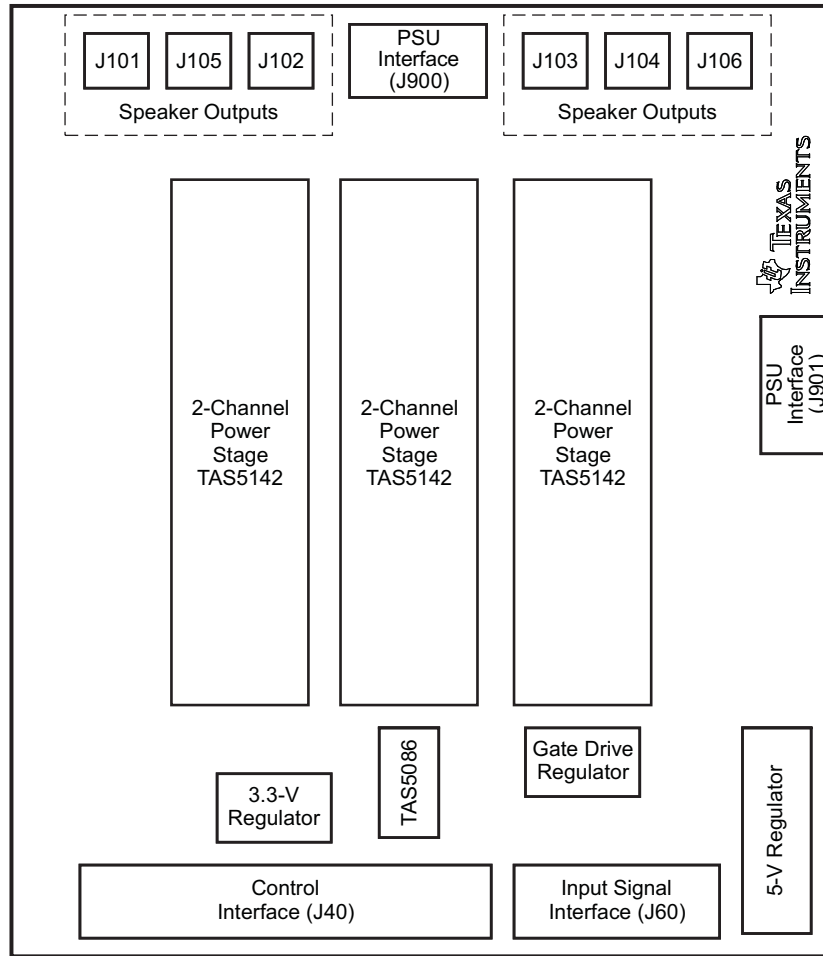

M0078-01

Figure 2. Physical Structure for the TAS5142DDV6EVM2 (Approximate Layout)

2 Quick Setup Guide

This chapter describes the TAS5142DDV6EVM2 board regarding power supplies and system interfaces. The chapter provides information on handling and unpacking, absolute operating conditions, and a description of the factory default switch and jumper configuration.

This chapter provides a step-by-step guide to configuring the TAS5142DDV6EVM2 for device evaluation.

2.1 Electrostatic Discharge Warning

Many of the components on the TAS5142DDV6EVM2 are susceptible to damage by electrostatic discharge (ESD). Customers are advised to observe proper ESD handling precautions when unpacking and handling the EVM, including the use of a grounded wrist strap at an approved ESD workstation.

CAUTION

Failure to observe ESD handling procedures may result in damage to EVM components.

2.2 Unpacking the EVM

On opening the TAS5142DDV6EVM2 package, check to ensure that the following items are included:

- 1 pc. TAS5142DDV6EVM2 board using one TAS5086DBT and three TAS5142DDVs
- 1 pc. TI input-USB board for interfacing TAS5142DDV6EVM2 with SPDIF/analog sources and PC for control
- 1 pc. signal interface IDC cable for connection to an I²S front end, such as the attached TI input-USB board
- 1 pc. control interface IDC cable for connection to an I²C front end, such as the attached TI input-USB board
- 1 pc. cable for connecting input-USB board to a USB port on a PC for TAS5086 control by software
- 1 pc. power-supply cable for two regulated power supplies (H-bridge and system supply)
- 1 pc. PurePath CD-ROM

If any of these items is missing, contact the Texas Instruments Product Information Center nearest you to inquire about a replacement.

Connect the input-USB board to the TAS5142DDV6EVM2 using the two IDC cables provided.

2.3 Power-Supply Setup

To power up the EVM, two power supplies are needed, one for system power, logic, and gate-drive, and one for the output-stage supply. Power supplies are connected to the EVM using the provided power cable red/black, white/black.

Table 2. Recommended Supply Voltages

Description	Voltage Limitations	Current Requirement	Cable
System power supply	15 V–20 V	0.3 A	Red/black
Output-stage power supply	0 V–32 V	10 A	White/black

CAUTION

Applying voltages above the limitations given in [Table 2](#) may cause permanent damage to your hardware.

Note: The length of the power-supply cable must be minimized. Increasing the length of the PSU cable increases the distortion for the amplifier at high output levels and low frequencies.

2.4 Speaker Connection

CAUTION

Both positive and negative speaker outputs are floating and may not be connected to ground (e.g., through an oscilloscope).

2.5 GUI Software Installation

The TAS5086 GUI provides easy control of all registers in TAS5086. To install the GUI, run the setup file from the PurePath CD-ROM.

After installation, turn on the power supplies and connect the USB cable to the input-USB board.

Start the GUI program from the Windows™ menu. Start-up of the GUI takes a few seconds.



C001

Figure 3. TAS5086 GUI Window

From the files menu, load the configuration file:

TAS5142DDV6EVM2 Configuration (2.00).cfg

The file is located on the PurePath CD-ROM. This file contains all settings for a default setup of the EVM.

For easy access of the file, it is recommended to copy the file into the directory where the GUI is installed. Default is C:\Program Files\Texas Instruments Inc\TAS5086\.

For more advanced use of the GUI, see the GUI User's Guide on the PurePath CD-ROM and the *TAS5086 PurePath Digital Audio Six-Channel PWM Processor* data sheet ([SLES131](#)).

3 Protection

This chapter describes the short-circuit protection and fault reporting circuitry of the TAS5142 device.

3.1 Short-Circuit Protection and Fault Reporting Circuitry

The TAS5142 is a self-protecting device that provides fault reporting (including high-temperature protection and short-circuit protection). The TAS5142 is configured in back-end auto-recovery mode and therefore resets automatically after all errors (M1 and M3 are set low, M2 is set high); see the *TAS5142 Stereo Digital Amplifier Power Stage* data sheet ([SLES126](#)) for further explanation. This means that the device will protect itself after an error condition and report the error through the \overline{SD} error signal.

3.2 Fault Reporting

The \overline{OTW} and \overline{SD} outputs from the TAS5142 indicate fault conditions. See the *TAS5142 Stereo Digital Amplifier Power Stage* data sheet ([SLES126](#)) for a description of these pins.

Table 3. TAS5142 Warning/Error Signal Decoding

\overline{OTW}	\overline{SD}	Device Condition
0	0	High-temperature error and/or high-current error
0	1	High-temperature warning
1	0	Undervoltage lockout or high-current error
1	1	Normal operation, no errors/warnings

The temperature warning signals at the TAS5142DDV6EVM2 board are wired-OR to one temperature warning signal (\overline{OTW} – pin 22 in control interface connector). Shutdown signals are wired-OR into one shutdown signal (\overline{SD} – pin 20 in control interface connector).

The shutdown signals, together with the temperature warning signal, give chip state information as described in [Table 3](#). Device fault-reporting outputs are open-drain outputs.

4 TAS5142DDV6EVM2 Performance

Table 4. General Test Conditions

General Test Conditions		Notes
Output stage supply voltage	32 V	Laboratory power supply (EA-PS 7065-10A)
System supply voltage	15 V	
Load Impedance	4 Ω	
Input signal	1-kHz sine	
Sampling frequency	48 kHz	
Gain setting in TAS5086	0 dB	
Measurement filter	AES17 and AUX-0025	
TI input-USB board	Input-USB	Rev 9 S/N:898
EVM configuration file	Ver 2.00	TAS5142DDV6EVM2 Configuration (2.00).cfg

Table 5. TAS5086 Register Settings⁽¹⁾

Register Name	Register Number	Value	Notes
Oscillator trim register	0x1B	0x00	Initiate oscillator to factory trim
Master volume register	0x07	0x30	Set volume to 0 dB
Modulation limit register	0x10	0x04	Set maximum modulation to 96.1%
Split-capacitor charge period register	0x1A	0x00	No split-capacitor charge period
PWM start register	0x18	0x30	
Input mux register	0x20	00 01 23 45	
PWM mux register	0x25	00 01 23 45	
System control register	0x05	0x20	

⁽¹⁾ These register settings are used for all tests, unless otherwise specified.

Table 6. Electrical Data

Electrical Data		Notes/Conditions
Output power, 4 Ω	80 W	1 kHz, unclipped (0 dBFS), $T_A = 25^\circ\text{C}$
Output power, 4 Ω	100 W	1 kHz, 10% THD+N, $T_A = 25^\circ\text{C}$
Maximum peak current	>10 A	1-kHz burst, 1 Ω , $R_{OC} = 22 \text{ k}\Omega$
Output stage efficiency	83%	1 kHz, $2 \times 100 \text{ W}$, 4 Ω
Damping factor	12	1 kHz, relative to 8- Ω load
System supply current	<200 mA	1-kHz, -60-dBFS signal, with TI input board
H-bridge supply current	<250 mA	1-kHz, -60-dBFS signal
Total board idle power consumption	11 W	H-bridge supply + system supply, -60-dBFS signal

Table 7. Audio Performance

Audio Performance			Notes/Conditions
THD+N, 4 Ω	1 W	< 0.08%	1 kHz
THD+N, 4 Ω	10 W	< 0.15%	1 kHz
THD+N, 4 Ω	80 W	< 0.25%	1 kHz
Dynamic range		> 105 dB	Ref: rated power, A-weighted, AES17 filter, 6-ch average
Noise voltage		< 85 μVrms	A-weighted, AES17
Click/pop		< 20 mV	Mute/unmute, no signal, 4 Ω
Channel separation		> 58 dB	1 kHz
Frequency response:		±1 dB	80 W/4 Ω, unclipped (0 dBFS)

Table 8. Thermal Specification

Thermal Specification	T _{HEATSINK} ⁽¹⁾	Notes/Conditions
Idle, all channels switching	40°C	1 kHz, 15 min, -60-dBFS signal, T _A = 25°C
4 × 10 W, 4 Ω + 2 × 21 W, 4 Ω (1/8 power)	68°C	1 kHz, 1 h, T _A = 25°C
2 × 80 W, 4 Ω	83°C	1 kHz, 5 min, T _A = 25°C

⁽¹⁾ Measured on surface of heat sink

Table 9. Physical Specifications

Physical Specifications	Notes/Conditions
PCB dimensions	115 × 135 × 50 Width × length × height (mm)
Total weight	330 g Components + PCB + heat sink + mechanics

Note: All electrical and audio specifications are typical values.

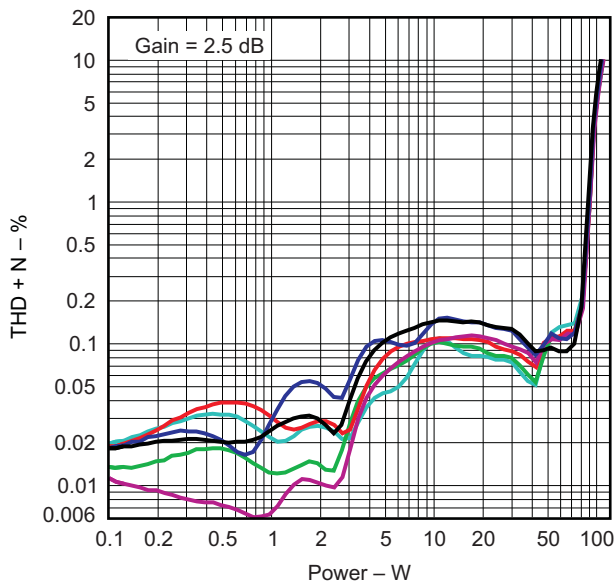

G001

Figure 4. THD+N vs Power (4 Ω)

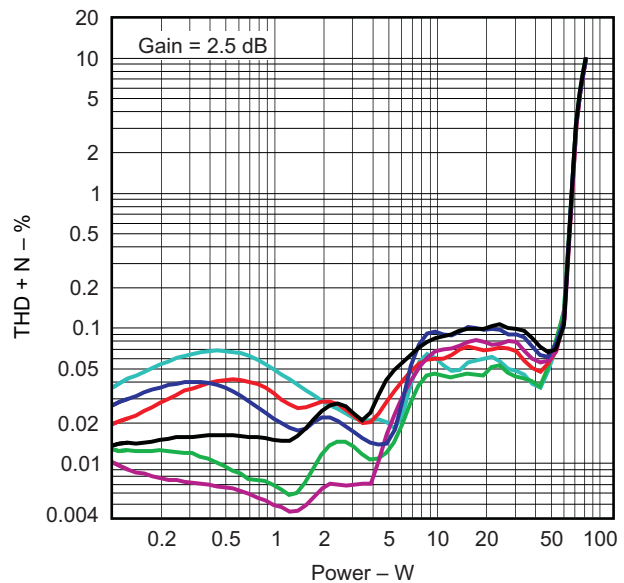

G002

Figure 5. THD+N vs Power (6 Ω)

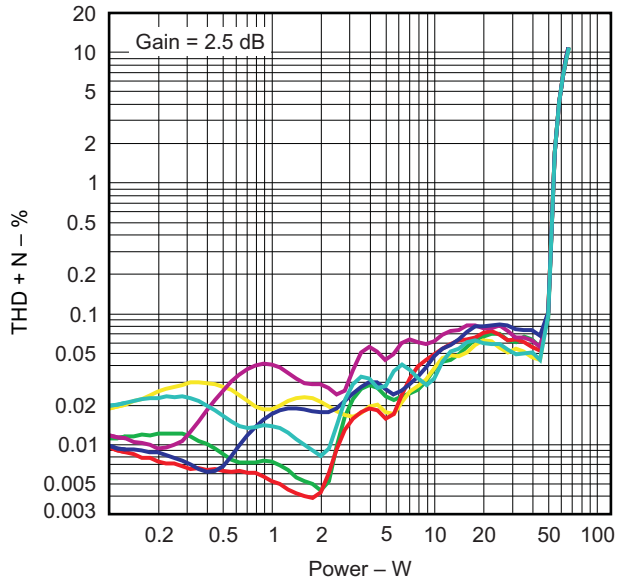

G003

Figure 6. THD+N vs Power (8 Ω)

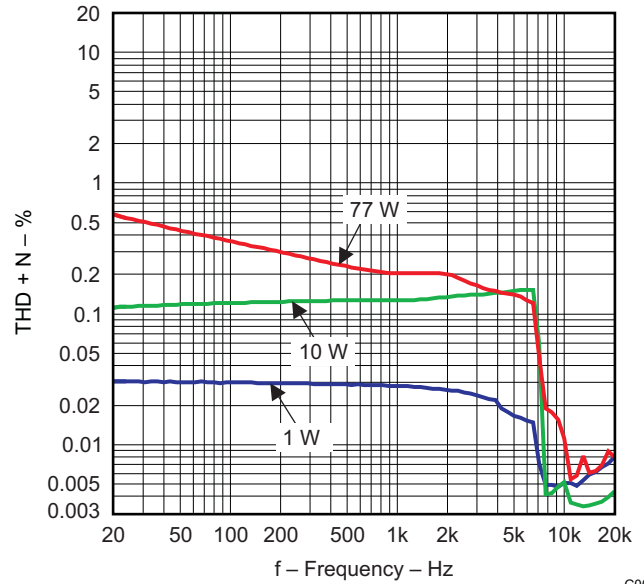

G004

Figure 7. THD+N vs Frequency (4 Ω)

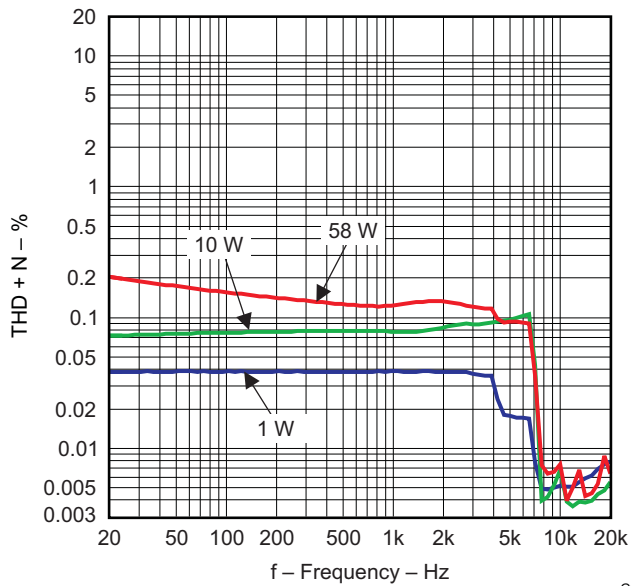

G005

Figure 8. THD+N vs Frequency (6 Ω)

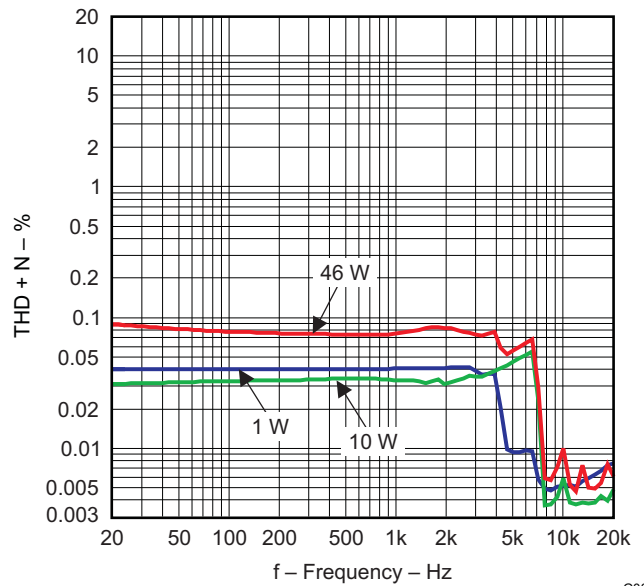

G006

Figure 9. THD+N vs Frequency (8 Ω)

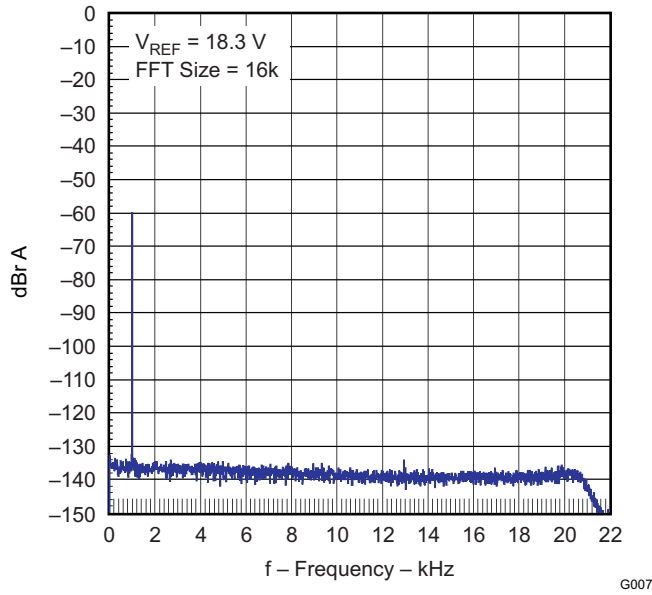

Figure 10. FFT Spectrum With -60 dBFS Tone

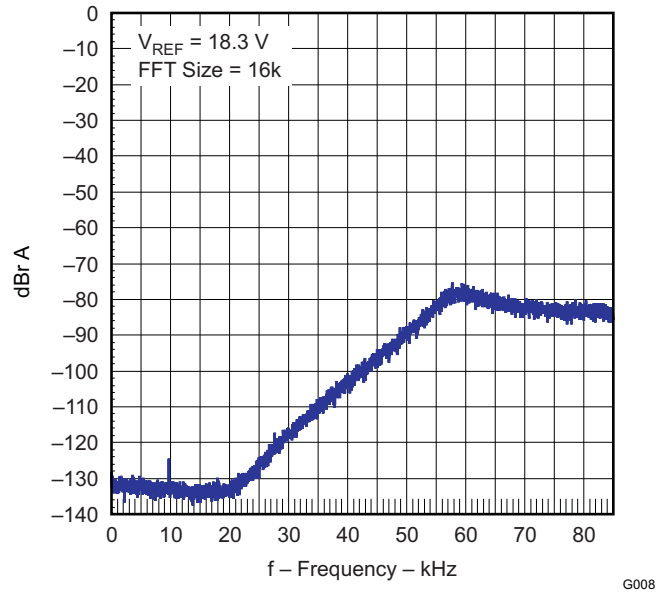

Figure 11. Idle Noise FFT Spectrum

Channel separation is tested for two channels, channel 1 and channel 2. Both channels use 4-Ω loads. The channel 1 input signal is 0 dBFS; channel 2 is muted. Reference voltage is 18.3 Vrms.

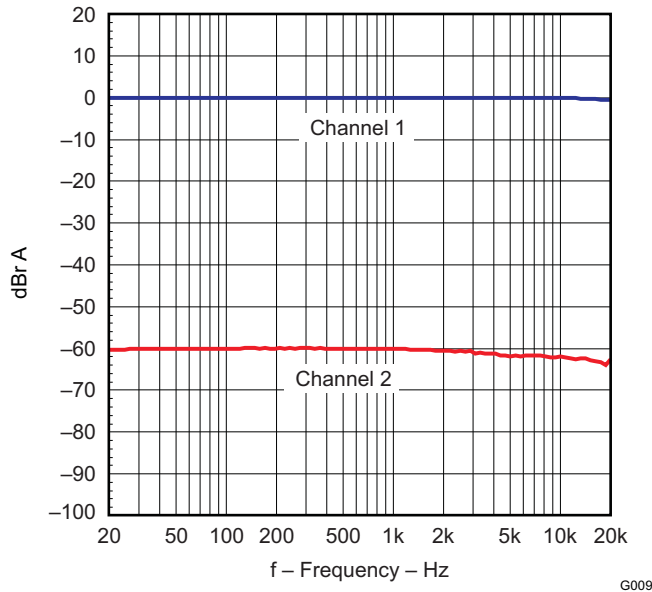

Figure 12. Channel Separation

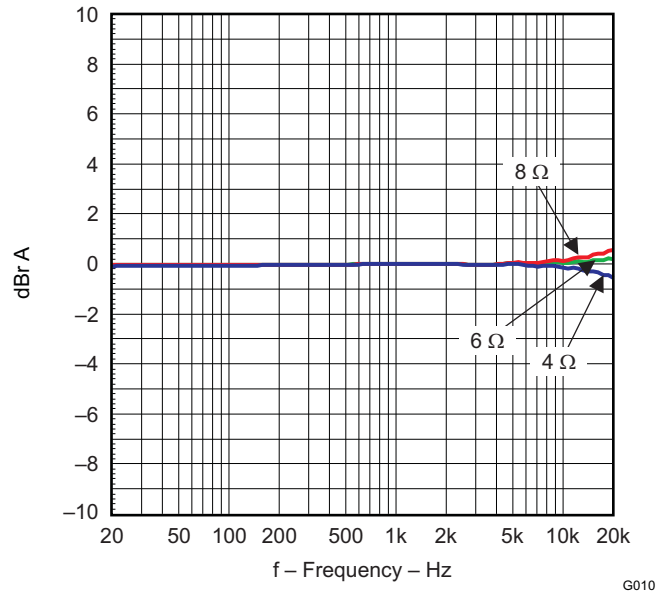
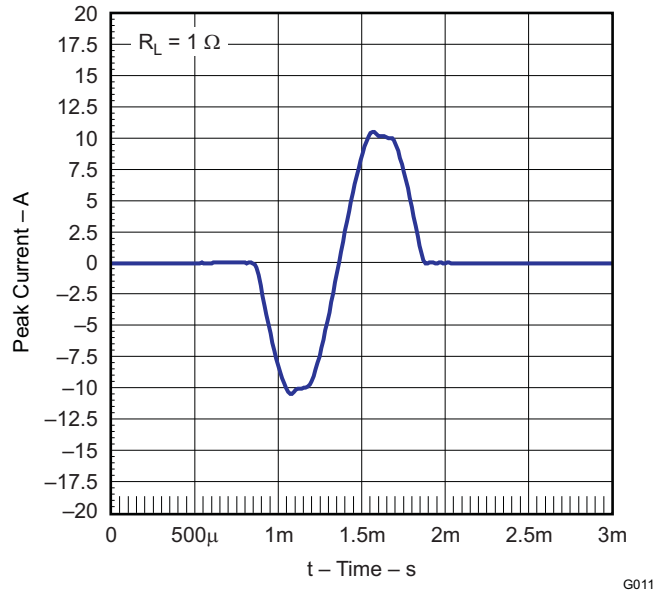

Figure 13. Frequency Response



G011

Figure 14. High Current Protection

No input signal is applied. Load is 4Ω .

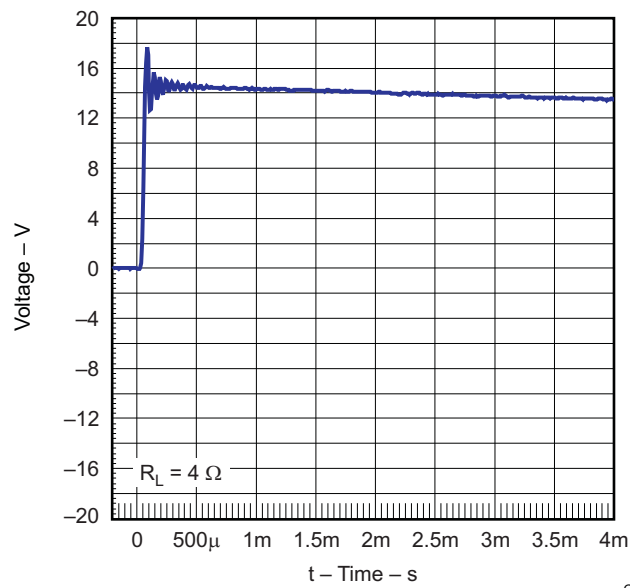

G012

Figure 15. Pop/Click

Efficiency is tested with 2 channels loaded at 4 Ω. The board has been preheated for 1 hour at 1/8 output power.

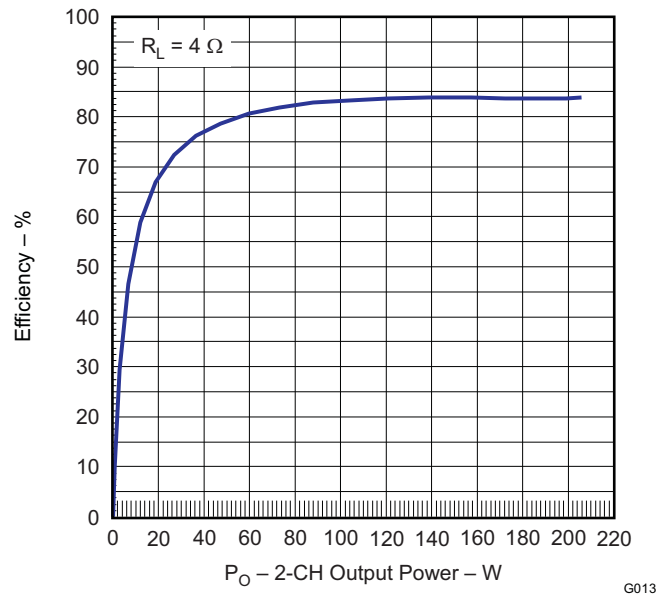

Figure 16. Output Stage Efficiency

G013

5 Related Documentation from Texas Instruments

The following table contains a list of data manuals that have detailed descriptions of the integrated circuits used in the design of the TAS5142DDV6EVM2. The data manuals can be obtained at the URL <http://www.ti.com>.

Part Number	Literature Number
TAS5086	SLES131
TAS5142	SLES126
TPS3825-33	SLVS165
TPS76433	SLVS180
UA78M12	SLVS059

5.1 Additional Documentation

1. *PC Configuration Tool for TAS5086* (TAS5086 GUI version 4.0 or later), on the PurePath CD-ROM
2. *System Design Considerations for True Digital Audio Power Amplifiers* ([SLAA117](#))
3. *Digital Audio Measurements* ([SLAA114](#))
4. *PSRR for PurePath Digital Audio Amplifiers* ([SLEA049](#))
5. *Power Rating in Audio Amplifier* ([SLEA047](#))
6. *PurePath Digital AM Interference Avoidance* ([SLEA040](#))
7. *Click and Pop Measurements Technique* ([SLEA044](#))
8. *Power Supply Recommendations for DVD-Receivers* ([SLEA027](#))
9. *Implementation of Power Supply Volume Control* ([SLEA038](#))

Appendix A Design Documents

A.1 TAS5142DDV6EVM2 Schematic



Design Name: TAS5142DDV6EVM2
Type: Mass Market Evaluation Module
File Name: A799-SCH-001.DSN
Version: 5.00
Date: 21.Nov. 2006
Design Engineer: Tomas Bruunshuus (tbs@ti.com), Jonas Holm (jhh@ti.com)
Audio Configuration: 5.1 PurePath Digital Amplifier Design
 1 x TAS5086, 3 x TAS5142DDV

Interfaces:
 J40: 34 pin IDC Header for Control, I2C and +5V
 J60: 16 pin IDC Header for I2S Audio
 J101-J106: 2 pin 3.96mm Headers for Speakers
 J901: 4 pin 3.96mm Header for H-Bridge and System Power Supply

Setup:
 6 x 4 ohm Speaker Loads
 +32V H-Bridge and +15V System Power Supplies

Performance:
 6 x 100W/4ohm (BTL) - all 10% THD+N
 100dB Dynamic Range

Page
 1/7: Front Page and Schematic Disclaimer
 2/7: Overview - Modulator, Input/Output and Headphone/Line Output Connectors
 3/7: 4 Channel BTL Power Stage (FL and C)
 4/7: 2 Channel BTL Power Stage (FR and RL)
 5/7: 2 Channel BTL Power Stage (RR and LFE SW)
 6/7: Power Supplies
 7/7: Mechanics

Schematic Disclaimer

The schematic information and materials ("Materials") provided here are provided by Texas Instruments and its suppliers to you to assist you in your design and development efforts. You may not copy, modify, or distribute these Materials, in whole or in part, without the express written consent of Texas Instruments. By downloading or viewing these Materials, you are agreeing to these terms.

1.) These evaluation schematics are intended for use for ENGINEERING DEVELOPMENT AND EVALUATION PURPOSES ONLY and are not considered by Texas Instruments to be fit as a basis for establishing production products or systems. This information may be incomplete in several respects, including but not limited to information relating to required design, marketing, and/or manufacturing-related protective considerations and product safety measures typically found in the end-product incorporating the goods.

2.) Accordingly, neither TI nor its suppliers warrant the accuracy or completeness of the information, text, graphics, links or other items contained within the Materials. TI may make changes to the Materials, or to the products described therein, at any time without notice. TI makes no commitment to update the Materials.

3.) TI assumes no liability for applications assistance, customer product design, software performance, or services that may be described or referenced in the Materials. The user assumes all responsibility and liability for proper and safe design and handling of goods. Accordingly, the user indemnifies TI from all claims arising from its use of the Materials.

4.) TI currently deals with various customers for products, and therefore our arrangement with the user will not be exclusive. TI makes no representations regarding the commercial availability of non-TI components that may be referenced in the Materials.

5.) No license is granted under any patent right or other intellectual property right of TI covering or relating to any combination, machine, or process in which such TI products or services might be or are used. Except as expressly provided herein and its suppliers do not grant any express or implied right to you under any patents, copyrights, trademarks, or other intellectual property rights of TI.

6.) Performance tests and ratings, to the extent referenced in the Materials, are measured using specific computer systems and/or components and reflect the approximate performance of TI products as measured by those tests. Any difference in system hardware or software design or configuration may affect actual performance. Buyers should consult other sources of information to evaluate the performance of systems or components they are considering purchasing.

7.) Results of TI's products or services with statements different from or beyond the parameters stated by TI for that product or service in official TI data books or data sheets voids all express and any implied warranties for the associated TI product or service, and is an unfair and deceptive business practice, and TI is not responsible for any such use.

8.) The Materials are copyrighted and any unauthorized use may violate copyright, trademark, and other laws. You may only download one copy for your internal use only, unless you are specifically licensed to do otherwise by TI in writing. This is a license, not a transfer of title, and is subject to the following restrictions: You may not: (a) modify the Materials; (b) create derivative works based on the Materials; (c) use the Materials for any commercial or other business purpose, or any public display, performance, sale or rental; (d) decompile, reverse engineer, or disassemble software Materials except and only to the extent permitted by applicable law; (e) remove any copyright or other proprietary notices from the Materials; (f) transfer the Materials to another person. You agree to prevent any unauthorized copying of the Materials. TI may terminate this license at any time if you are in breach of the terms of this Agreement. Upon termination, you will immediately destroy the Materials.

9.) THE MATERIALS ARE PROVIDED "AS IS" WITHOUT ANY EXPRESS OR IMPLIED WARRANTY OF ANY KIND INCLUDING WARRANTIES OF MERCHANTABILITY, NON-INFRINGEMENT OF INTELLECTUAL PROPERTY, OR FITNESS FOR ANY PARTICULAR PURPOSE. TI DISCLAIMS ALL WARRANTIES, INCLUDING, WITHOUT LIMITATION, DAMAGES FOR LOSS OF PROFITS, BUSINESS INTERRUPTION, LOSS OF INFORMATION, ARISING OUT OF THE USE OF OR INABILITY TO USE THE MATERIALS, EVEN IF TI HAS BEEN ADVISED OF THE POSSIBILITY OF SUCH DAMAGES.

Figure A-1. TAS5142DDV6EVM2 Schematic (Sheet 1 of 7)

S001

Copyright 2005 Texas Instruments, Inc. - All rights reserved - The TI and PurePath Digital logos are trademarks of Texas Instruments.

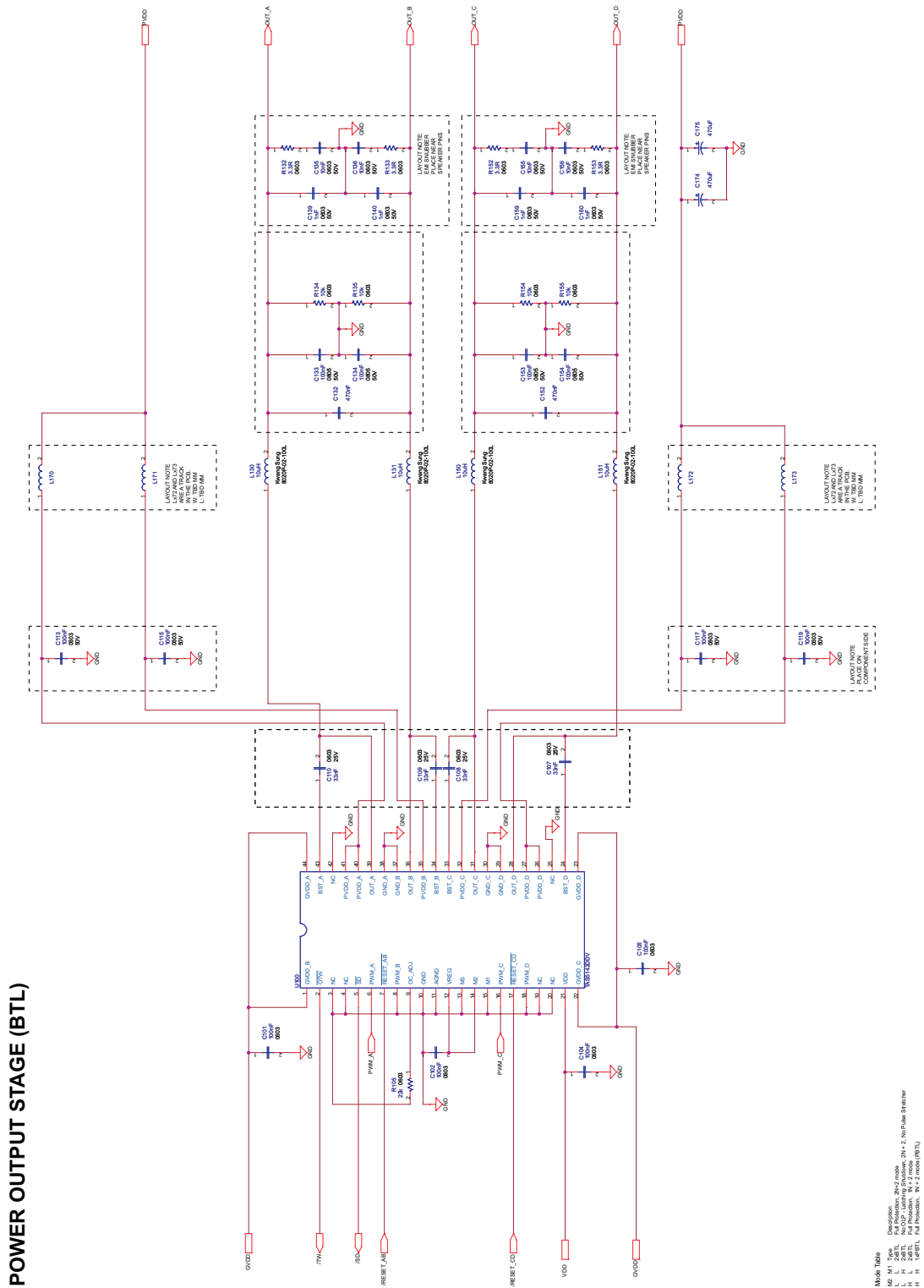

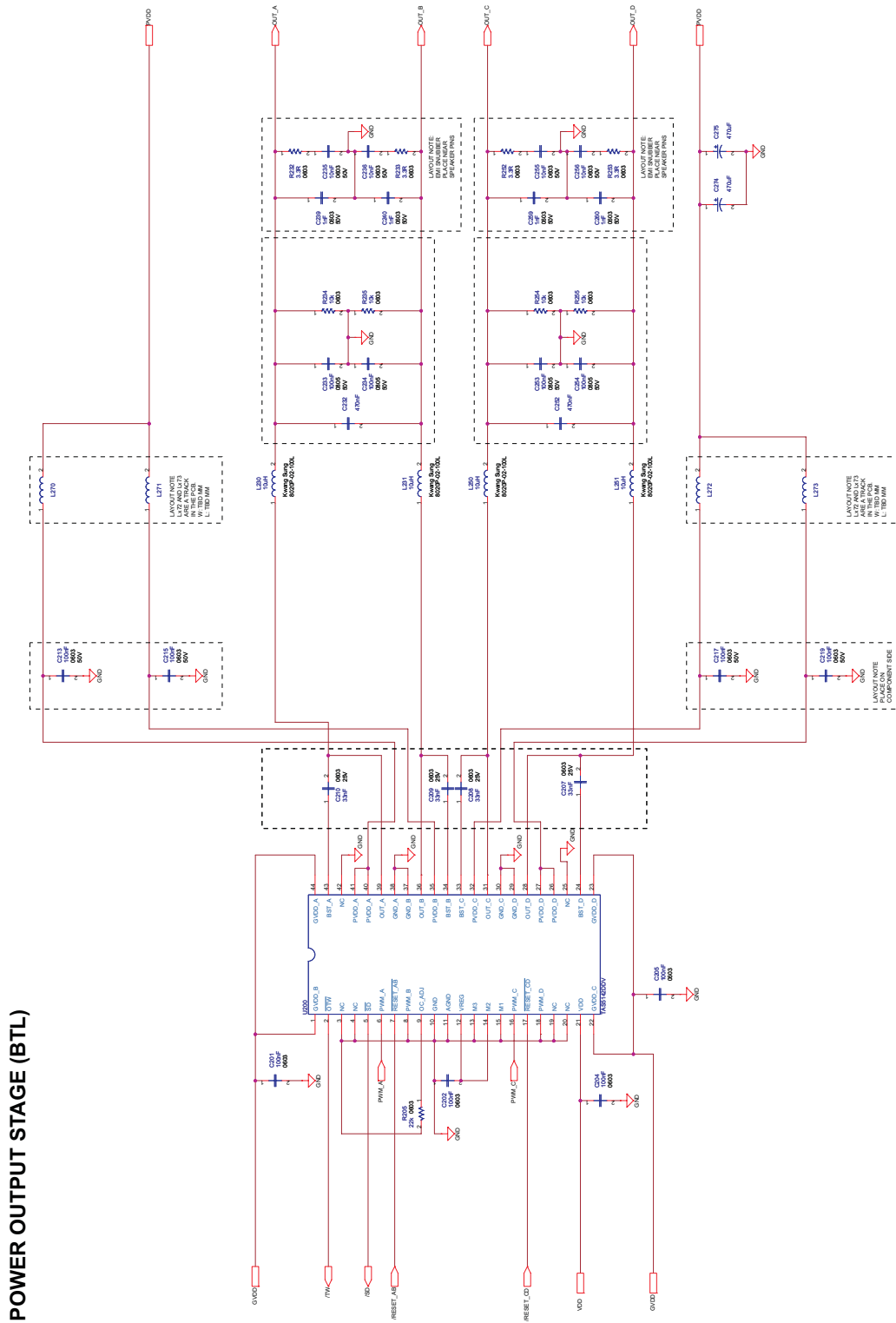

Figure A-4. TAS5142DDV6EVM2 Schematic (Sheet 4 of 7)

Meta Title: TAS5142DDV6EVM2 Schematic (Sheet 4 of 7)
 Meta Description: TAS5142DDV6EVM2 Schematic (Sheet 4 of 7)
 Meta Keywords: TAS5142DDV6EVM2 Schematic (Sheet 4 of 7)

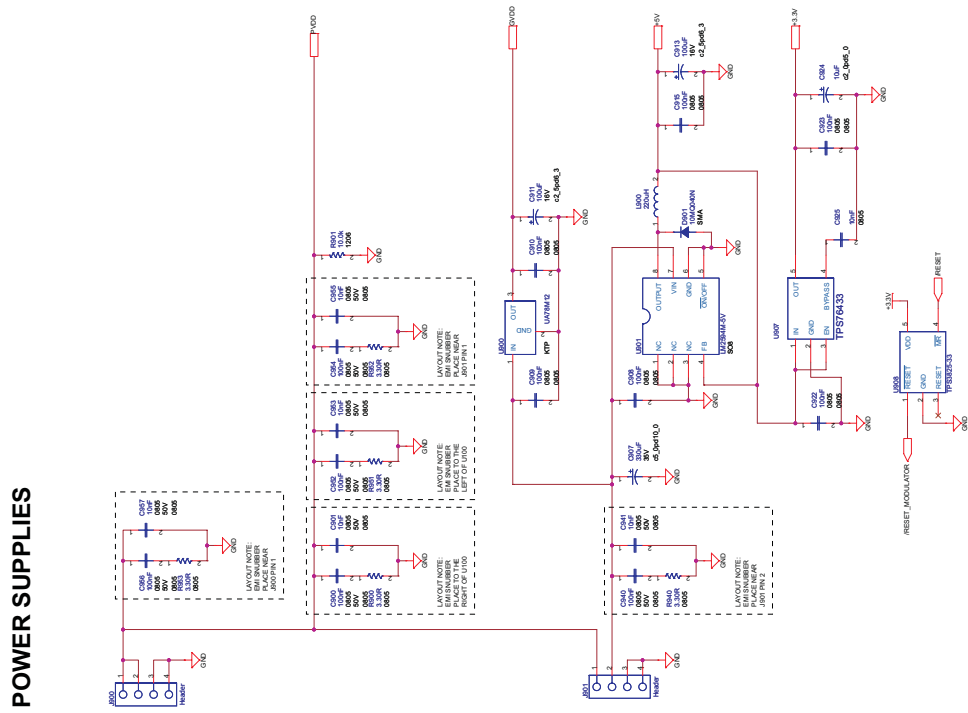

Figure A-6. TAS5142DDV6EVM2 Schematic (Sheet 6 of 7)

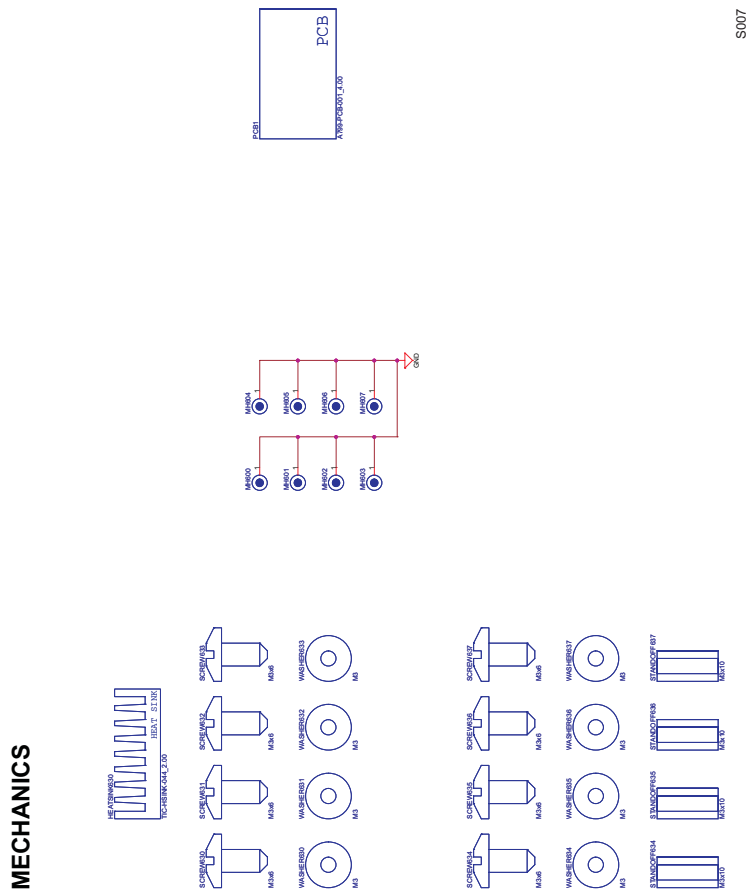

Figure A-7. TAS5142DDV6EVM2 Schematic (Sheet 7 of 7)

A.2 TAS5142DDV6EVM2 Parts List

Table A-1. Parts List

Part Reference	QTY	Description	Manufacture	First MFR P/N
C10 C13 C40 C41 C135 C136 C155 C156 C235 C236 C255 C256 C335 C336 C355 C356	16	Ceramic 10-nF, 50-V, 20% X7R 0603 capacitor	BC Components	0603B103M500NT
C11 C12 C14 C17 C21 C22 C25 C26 C50 C101 C102 C104 C105 C201 C202 C204 C205 C301 C302 C304 C305	21	Ceramic 100-nF, 16-V, 20% X7R 0603 capacitor	BC Components	0603B104M160NT
C51 C924	2	Electrolytic 10- μ F, 16-V, 20% aluminium 2-mm 5-mm M-series general-purpose capacitor	Panasonic	ECA1CM100
C107 C108 C109 C110 C207 C208 C209 C210 C307 C308 C309 C310	12	Ceramic 33-nF, 25-V, 20% X7R 0603 capacitor	BC Components	0603B333M250NT
C113 C115 C117 C119 C213 C215 C217 C219 C313 C315 C317 C319	12	Ceramic 100-nF, 50-V, 20% X7R 0603 capacitor	Vishay	VJ0603Y104MXATW1BC
C132 C152 C232 C252 C332 C352	6	Metal film 470-nF, 63-V, 10% polyester 5-mm (W: 4,5 mm L: 7,2 mm) capacitor	Wima	MKS 2 0.47 μ F/105/63Vdc PCM5
C133 C134 C153 C154 C233 C234 C253 C254 C333 C334 C353 C354 C900 C908 C909 C910 C915 C922 C923 C940 C952 C954 C956	23	Ceramic 100-nF, 50-V, 20% X7R 0805 capacitor	BC Components	0805B104M500NT
C139 C140 C159 C160 C239 C240 C259 C260 C339 C340 C359 C360	12	Ceramic 1-nF, 50-V, 10% NP0 0603 capacitor	BC Components	0603N102K500NT
C174 C175 C274 C275 C374 C375	6	Electrolytic 470- μ F, 35-V, 20% aluminium 5-mm m FC-series low-impedance capacitor	Panasonic	EEUFC1V471
C901 C925 C941 C953 C955 C957	6	Ceramic 10-nF, 50-V, 20% X7R 0805 capacitor	BC Components	0805B103M500NT
C907	1	Electrolytic 330- μ F, 35-V 20% aluminium 5-mm m FC-series low-impedance capacitor	Panasonic	EEUFC1V331
C911 C913	2	Electrolytic 100- μ F, 16-V, 20% aluminium 2,5-mm mm ultramini-series capacitor	Sang Jing Electronics	UMR16V107M6.3X5
D901	1	1-A, 40-V Schottky diode (SMA)	International Rectifier	10MQ040N
HEATSINK630	1	Heat sink for 3 DDV packages, length 110 mm	THF-Teknik	TIC-HSINK-044(2.00)
J40	1	34 pins/2 rows/2,54-mm pitch vertical male IDC	Molex	87256-3411
J60	1	16 pins/2 rows/2,54-mm pitch vertical male IDC	Molex	87256-1611
J101 J102 J103 J104 J105 J106	6	2 pins/1 row/3,96-mm pitch vertical male pin header	JST	BEP-VH
J900 J901	2	4 pins/1 row/3,96-mm pitch vertical male pin header	JST	B4P-VH
L130 L131 L150 L151 L230 L231 L250 L251 L330 L331 L350 L351	12	10- μ H ferrite inductor	Kwang Sung	8020P-02-100L
L900	1	220 μ H, 0.5-A, 20% (390mR) magnetically shielded ferrite inductor	Coil Craft	DT3316P-224
PCB1	1	TAS5142DDV6EVM2 printed circuit board (version 4.00) - Allegro	Printline	A799-PCB-001(4.00)
Q40 Q50	2	100-mA, 45-V PNP small signal transistor (SOT-23)	Philips	9335 897 40215
Q41	1	100-mA, 45-V NPN small-signal transistor (SOT-23)	Philips	9335 895 70215

Table A-1. Parts List (continued)

Part Reference	QTY	Description	Manufacture	First MFR P/N
R10 R11	2	220-Ω, 100-mW 5% 0603 metal film resistor	BC Components	DCT 0603 5% 220R
R18	1	18.0-kΩ, 100-mW, 1% 0603 metal film resistor	BC Components	DCT 0603 1% 18k0
R19 R40 R41 R42 R43 R44 R45 R46 R47 R48 R67 R68 R69 R70 R71 R72 R73 R76 R134 R135 R154 R155 R234 R235 R254 R255 R334 R335 R354 R355	30	10-kΩ, 100-mW, 5% 0603 metal film resistor	BC Components	DCT 0603 5% 10k0
R50 R132 R133 R152 R153 R232 R233 R252 R253 R332 R333 R352 R353	13	3.3-Ω, 100-mW, 5% 0603 metal film resistor	BC Components	DCT 0603 5% 3R30
R51 R52	2	1.0-kΩ, 100-mW, 5% 0603 metal film resistor	BC Components	DCT 0603 5% 1k00
R53	1	100-kΩ, 100-mW, 5% 0603 metal film resistor	BC Components	DCT 0603 5% 100k
R54 R55 R56 R57 R58 R60 R61 R62 R63 R64 R65 R66 R74 R75	14	47-Ω, 100-mW, 5% 0603 metal film resistor	BC Components	DCT 0603 5% 47R0
R105 R205 R305	3	22-kΩ, 100-mW, 5% 0603 metal film resistor	BC Components	DCT 0603 5% 22k0
R900 R940 R951 R952 R953	5	3.30-Ω, 125-mW, 1% 0805 metal film resistor	BC Components	DCU 0805 1% 3R30
R901	1	10.0-kΩ, 250-mW, 1% 1206 metal film resistor	BC Components	DCA 1206 1% 10k0
SCREW630 SCREW631 SCREW632 SCREW633 SCREW634 SCREW635 SCREW636 SCREW637	8	M3x6, pan head, Pozidriv™, A2 screw	Bossard	BN 81882 M3x6
STANDOFF634 STANDOFF635 STANDOFF636 STANDOFF637	4	M3x10 aluminium standoff	Ettinger	05.03.108
U10	1	6-ch PWM processor (SE, VOL, 192-kHz, I ² S out) (TSSOP38)	Texas Instruments	TAS5086DBT
U100 U200 U300	3	4-ch/2-ch/1-ch digital audio PWM power output stage (DDV44)	Texas Instruments	TAS5142DDV
U908	1	3.3-V supply voltage supervisor (SOT23-5)	Texas Instruments	TPS3825-33DBVT
U900	1	12-V, 500-mA positive voltage regulator (KTP)	ON/Motorola	MC78M12CDTG
U901	1	5-V, 0.5-A buck converter (SO8)	National Semiconductor	LM2594M-5.0V
U907	1	3.3-V, 150-mA low-drop linear regulator (SOT23-5)	Texas Instruments	TPS76433DBVR
WASHER630 WASHER631 WASHER632 WASHER633 WASHER634 WASHER635 WASHER636 WASHER637	8	M3 stainless steel spring washer	Bossard	BN 760 M3

A.3 TAS5142DDV6EVM2 PCB Specification (Version 4.00)

Board identification:	A799-PCB-001(4.00)
Board type:	Double-sided plated-through board
Laminate type:	FR4
Laminate thickness:	1,6 mm
Copper thickness:	70 µm (incl. plating exterior layer)
Copper plating of holes:	>25 µm
Minimum hole diameter :	0,3 mm
Silkscreen, component side:	White - remove silkscreen from solder area and pre-tinned areas
Silkscreen, solder side:	None
Solder mask, component side:	Green
Solder mask solder side:	Green
Protective coating:	Solder coating and chemical silver on free copper
Electrical test:	PCB must be electrically tested
Manufactured to:	PERFAG 2E (www.perfag.dk)
Aperture table:	PERFAG 10A (www.perfag.dk)
Board size:	115 mm x 137 mm
Comments:	See drill information file (5140dri.plt.pdf).

A.4 TAS5142DDV6EVM2 PCB Layers

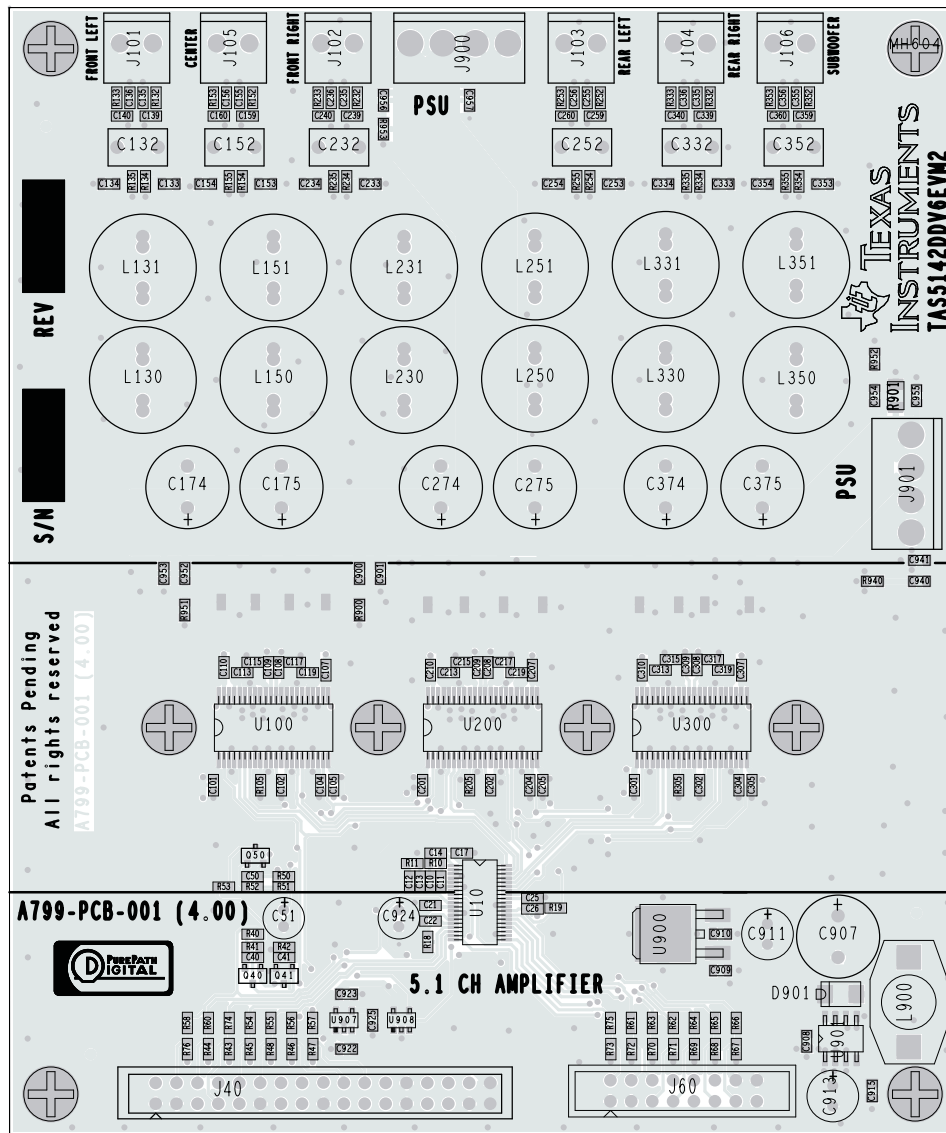

K001

Figure A-8. Component Layout



Figure A-9. Solder Side

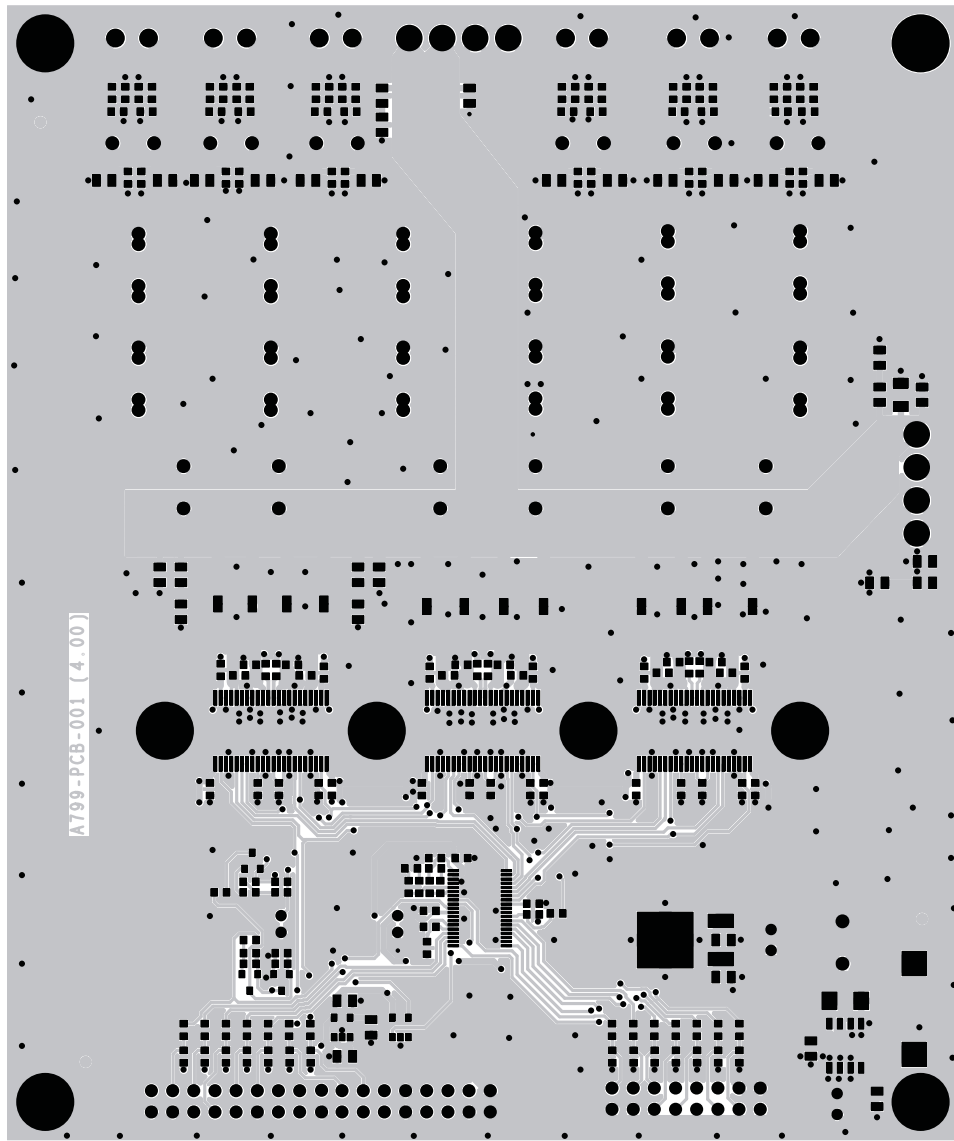
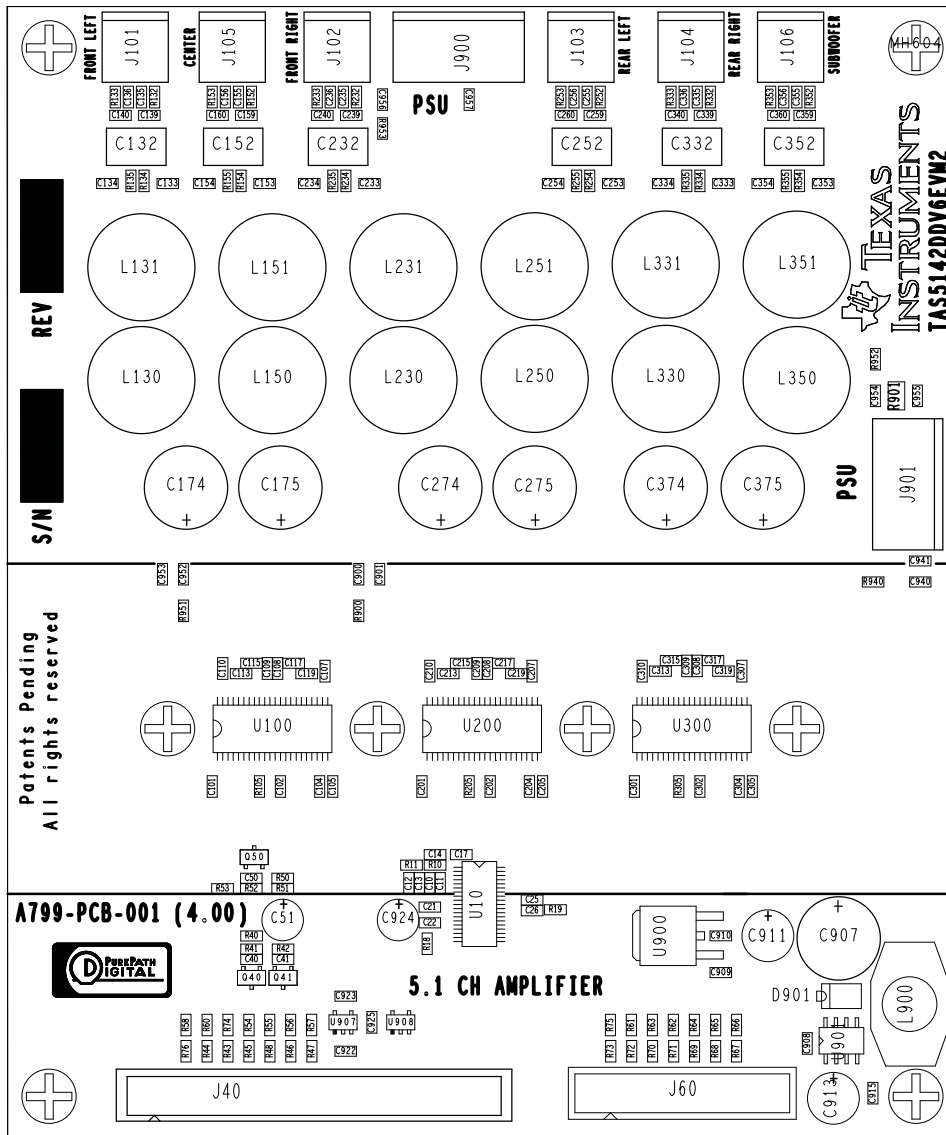

Figure A-10. Component Side



K004

Figure A-11. Component Placement

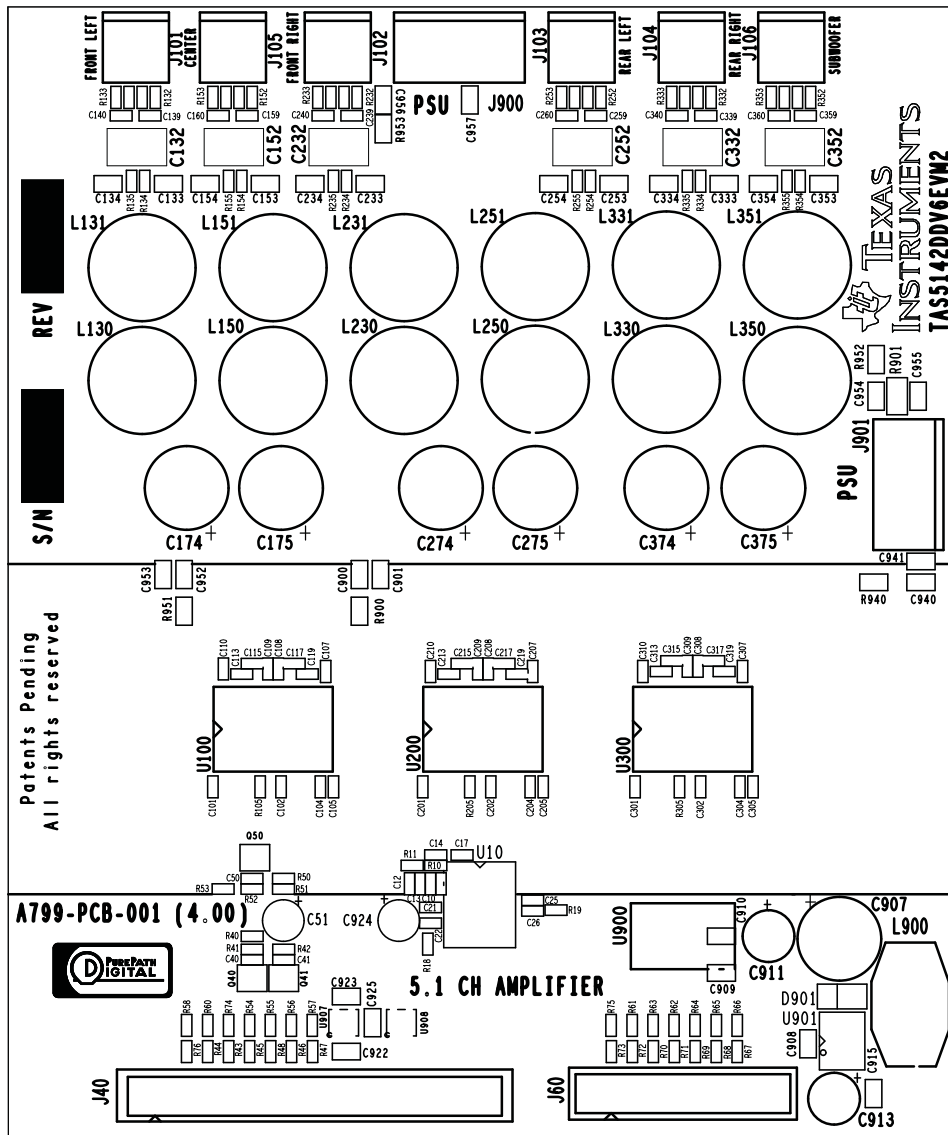
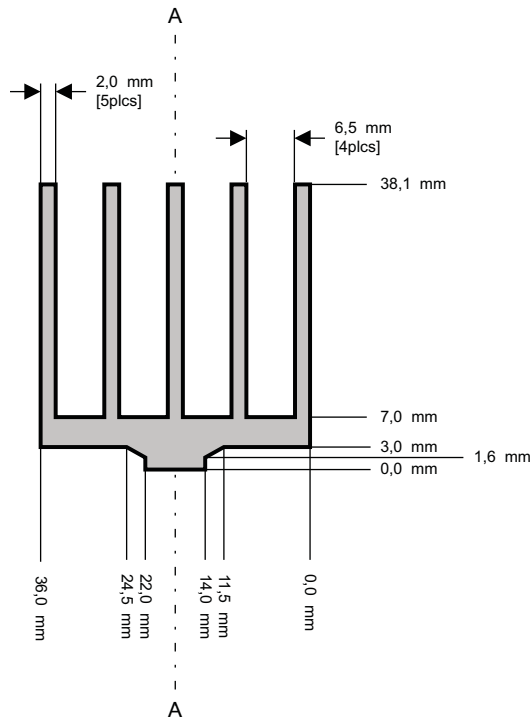
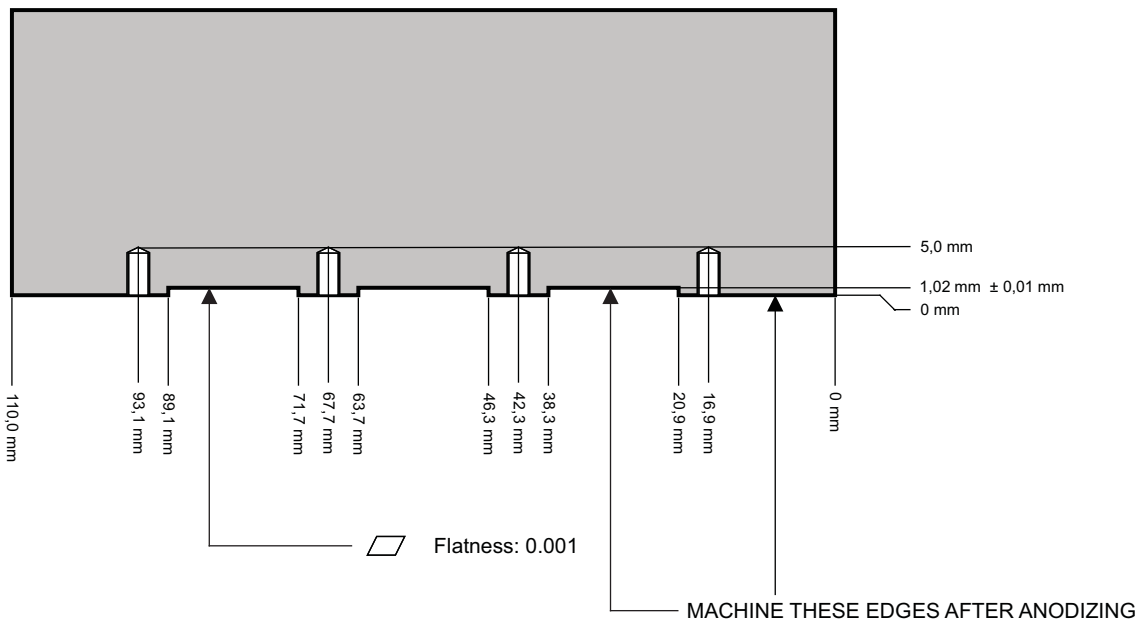

Figure A-12. Silkscreen

A.5 Heat Sink Drawing



Cross section A-A



PROFILE: TIC-HSINK-043 profile (1.00)

MATERIAL: ALUMINIUM

INTERNAL SCREW THREADS: M3

SURFACE: FREE OF SHARP EDGES

SURFACE TREATMENT: BLACK ANODIZED

TOLERANCES: ± 0,1 mm

M0079-01

Figure A-13. Heat Sink

A.6 Engineering Change Order

TAS5142DDV6EVM2 ECO-001 (5.00)
Jens Kroyer, 2008-04-02

TAS5142DDV6EVM2 Engineering Change Order

Affected Documents

Board Revision: REV 6

Title	Document Number	Issue
Schematic	A799-SCH-001	5.00
Printed Circuit Board	A799-PCB-001	4.00
Bill Of Material	A799-LST-001	5.00

Part list changes from version

Type	Value	Part Reference	Old P/N	New P/N
Changed	-	U900	Texas Instruments UA78M12CKTPR	ON/Motorola MC78M12CDTG

Please update board revision to "7".

Figure A-14. Engineering Change Order

EVALUATION BOARD/KIT IMPORTANT NOTICE

Texas Instruments (TI) provides the enclosed product(s) under the following conditions:

This evaluation board/kit is intended for use for **ENGINEERING DEVELOPMENT, DEMONSTRATION, OR EVALUATION PURPOSES ONLY** and is not considered by TI to be a finished end-product fit for general consumer use. Persons handling the product(s) must have electronics training and observe good engineering practice standards. As such, the goods being provided are not intended to be complete in terms of required design-, marketing-, and/or manufacturing-related protective considerations, including product safety and environmental measures typically found in end products that incorporate such semiconductor components or circuit boards. This evaluation board/kit does not fall within the scope of the European Union directives regarding electromagnetic compatibility, restricted substances (RoHS), recycling (WEEE), FCC, CE or UL, and therefore may not meet the technical requirements of these directives or other related directives.

Should this evaluation board/kit not meet the specifications indicated in the User's Guide, the board/kit may be returned within 30 days from the date of delivery for a full refund. **THE FOREGOING WARRANTY IS THE EXCLUSIVE WARRANTY MADE BY SELLER TO BUYER AND IS IN LIEU OF ALL OTHER WARRANTIES, EXPRESSED, IMPLIED, OR STATUTORY, INCLUDING ANY WARRANTY OF MERCHANTABILITY OR FITNESS FOR ANY PARTICULAR PURPOSE.**

The user assumes all responsibility and liability for proper and safe handling of the goods. Further, the user indemnifies TI from all claims arising from the handling or use of the goods. Due to the open construction of the product, it is the user's responsibility to take any and all appropriate precautions with regard to electrostatic discharge.

EXCEPT TO THE EXTENT OF THE INDEMNITY SET FORTH ABOVE, NEITHER PARTY SHALL BE LIABLE TO THE OTHER FOR ANY INDIRECT, SPECIAL, INCIDENTAL, OR CONSEQUENTIAL DAMAGES.

TI currently deals with a variety of customers for products, and therefore our arrangement with the user **is not exclusive.**

TI assumes **no liability for applications assistance, customer product design, software performance, or infringement of patents or services described herein.**

Please read the User's Guide and, specifically, the Warnings and Restrictions notice in the User's Guide prior to handling the product. This notice contains important safety information about temperatures and voltages. For additional information on TI's environmental and/or safety programs, please contact the TI application engineer or visit www.ti.com/esh.

No license is granted under any patent right or other intellectual property right of TI covering or relating to any machine, process, or combination in which such TI products or services might be or are used.

FCC Warning

This evaluation board/kit is intended for use for **ENGINEERING DEVELOPMENT, DEMONSTRATION, OR EVALUATION PURPOSES ONLY** and is not considered by TI to be a finished end-product fit for general consumer use. It generates, uses, and can radiate radio frequency energy and has not been tested for compliance with the limits of computing devices pursuant to part 15 of FCC rules, which are designed to provide reasonable protection against radio frequency interference. Operation of this equipment in other environments may cause interference with radio communications, in which case the user at his own expense will be required to take whatever measures may be required to correct this interference.

EVM WARNINGS AND RESTRICTIONS

It is important to operate this EVM within the input voltage range of 0 V to 32 V for the output stage and 15 V to 20 V for the system supply and the output voltage range of 0 V to 32 V.

Exceeding the specified input range may cause unexpected operation and/or irreversible damage to the EVM. If there are questions concerning the input range, please contact a TI field representative prior to connecting the input power.

Applying loads outside of the specified output range may result in unintended operation and/or possible permanent damage to the EVM. Please consult the EVM User's Guide prior to connecting any load to the EVM output. If there is uncertainty as to the load specification, please contact a TI field representative.

During normal operation, some circuit components may have case temperatures greater than 50°C. The EVM is designed to operate properly with certain components above 50°C as long as the input and output ranges are maintained. These components include but are not limited to linear regulators, switching transistors, pass transistors, and current sense resistors. These types of devices can be identified using the EVM schematic located in the EVM User's Guide. When placing measurement probes near these devices during operation, please be aware that these devices may be very warm to the touch.

Mailing Address: Texas Instruments, Post Office Box 655303, Dallas, Texas 75265
Copyright 2007, Texas Instruments Incorporated

IMPORTANT NOTICE

Texas Instruments Incorporated and its subsidiaries (TI) reserve the right to make corrections, modifications, enhancements, improvements, and other changes to its products and services at any time and to discontinue any product or service without notice. Customers should obtain the latest relevant information before placing orders and should verify that such information is current and complete. All products are sold subject to TI's terms and conditions of sale supplied at the time of order acknowledgment.

TI warrants performance of its hardware products to the specifications applicable at the time of sale in accordance with TI's standard warranty. Testing and other quality control techniques are used to the extent TI deems necessary to support this warranty. Except where mandated by government requirements, testing of all parameters of each product is not necessarily performed.

TI assumes no liability for applications assistance or customer product design. Customers are responsible for their products and applications using TI components. To minimize the risks associated with customer products and applications, customers should provide adequate design and operating safeguards.

TI does not warrant or represent that any license, either express or implied, is granted under any TI patent right, copyright, mask work right, or other TI intellectual property right relating to any combination, machine, or process in which TI products or services are used. Information published by TI regarding third-party products or services does not constitute a license from TI to use such products or services or a warranty or endorsement thereof. Use of such information may require a license from a third party under the patents or other intellectual property of the third party, or a license from TI under the patents or other intellectual property of TI.

Reproduction of TI information in TI data books or data sheets is permissible only if reproduction is without alteration and is accompanied by all associated warranties, conditions, limitations, and notices. Reproduction of this information with alteration is an unfair and deceptive business practice. TI is not responsible or liable for such altered documentation. Information of third parties may be subject to additional restrictions.

Resale of TI products or services with statements different from or beyond the parameters stated by TI for that product or service voids all express and any implied warranties for the associated TI product or service and is an unfair and deceptive business practice. TI is not responsible or liable for any such statements.

TI products are not authorized for use in safety-critical applications (such as life support) where a failure of the TI product would reasonably be expected to cause severe personal injury or death, unless officers of the parties have executed an agreement specifically governing such use. Buyers represent that they have all necessary expertise in the safety and regulatory ramifications of their applications, and acknowledge and agree that they are solely responsible for all legal, regulatory and safety-related requirements concerning their products and any use of TI products in such safety-critical applications, notwithstanding any applications-related information or support that may be provided by TI. Further, Buyers must fully indemnify TI and its representatives against any damages arising out of the use of TI products in such safety-critical applications.

TI products are neither designed nor intended for use in military/aerospace applications or environments unless the TI products are specifically designated by TI as military-grade or "enhanced plastic." Only products designated by TI as military-grade meet military specifications. Buyers acknowledge and agree that any such use of TI products which TI has not designated as military-grade is solely at the Buyer's risk, and that they are solely responsible for compliance with all legal and regulatory requirements in connection with such use.

TI products are neither designed nor intended for use in automotive applications or environments unless the specific TI products are designated by TI as compliant with ISO/TS 16949 requirements. Buyers acknowledge and agree that, if they use any non-designated products in automotive applications, TI will not be responsible for any failure to meet such requirements.

Following are URLs where you can obtain information on other Texas Instruments products and application solutions:

Products

Amplifiers	amplifier.ti.com
Data Converters	dataconverter.ti.com
DSP	dsp.ti.com
Clocks and Timers	www.ti.com/clocks
Interface	interface.ti.com
Logic	logic.ti.com
Power Mgmt	power.ti.com
Microcontrollers	microcontroller.ti.com
RFID	www.ti-rfid.com
RF/IF and ZigBee® Solutions	www.ti.com/lprf

Applications

Audio	www.ti.com/audio
Automotive	www.ti.com/automotive
Broadband	www.ti.com/broadband
Digital Control	www.ti.com/digitalcontrol
Medical	www.ti.com/medical
Military	www.ti.com/military
Optical Networking	www.ti.com/opticalnetwork
Security	www.ti.com/security
Telephony	www.ti.com/telephony
Video & Imaging	www.ti.com/video
Wireless	www.ti.com/wireless

Mailing Address: Texas Instruments, Post Office Box 655303, Dallas, Texas 75265
Copyright © 2008, Texas Instruments Incorporated