

Space and working time saved with new heat sink construction. Series now includes 480-VAC models to allow use in a greater range of applications.

- A comprehensive lineup that now includes 480-VAC models.
- Slim design with 3-phase output and built-in heat sinks.
- New heat sink construction with smaller mounting section.
- DIN track mounting supported as standard. (Screw mounting is also possible.)
- Certified by UL, CSA, and VDE.



 Refer to *Safety Precautions for All Solid State Relays.*

## Model Number Structure

### ■ Model Number Legend

G3PB-□□□-□□□-□  
 1      2 3 4    5 6 7

#### 1. Basic Model Name

G3PB: Solid State Relay

#### 2. Rated Load Power Supply Voltage

2: 200 VAC

5: 480 VAC

#### 3. Rated Load Current

15: 15 A

25: 25 A

35: 35 A

45: 45 A

#### 4. Terminal Type

B: Screw terminals

#### 5. Single-phase/3-phase and Number of Elements for 3-phase

2: 3-phase, 2-element models

3: 3-phase, 3-element models

#### 6. 3-phase Type

N: DIN track mounting and built-in heat sink

H: No heat sink ("hockey puck" type)

#### 7. Certification

VD: Certified by UL, CSA, and VDE

## Ordering Information

### ■ Solid State Contactors

#### Models with Built-in Heat Sinks

Applicable phase	Main circuit voltage	Zero cross function	Applicable load current (with Class-1 AC resistive load)	Number of poles	Model
3	100 to 240 VAC	Yes	15 A	3	G3PB-215B-3N-VD DC12-24
				2	G3PB-215B-2N-VD DC12-24
			25 A	3	G3PB-225B-3N-VD DC12-24
				2	G3PB-225B-2N-VD DC12-24
			35 A	3	G3PB-235B-3N-VD DC12-24
				2	G3PB-235B-2N-VD DC12-24
			45 A	3	G3PB-245B-3N-VD DC12-24
				2	G3PB-245B-2N-VD DC12-24
			200 to 480 VAC	15 A	3
	2				G3PB-515B-2N-VD DC12-24
	25 A			3	G3PB-525B-3N-VD DC12-24
				2	G3PB-525B-2N-VD DC12-24
	35 A			3	G3PB-535B-3N-VD DC12-24
				2	G3PB-535B-2N-VD DC12-24
	45 A			3	G3PB-545B-3N-VD DC12-24
				2	G3PB-545B-2N-VD DC12-24

**Note:** The applicable load current depends on the ambient temperature. When ordering, specify the rated input voltage.

#### Models with Externally Attached Heat Sinks

Applicable phase	Main circuit voltage	Zero cross function	Applicable load current (See note.)	Number of poles	Model
3	100 to 240 VAC	Yes	15 A	3	G3PB-215B-3H-VD DC12-24
				2	G3PB-215B-2H-VD DC12-24
			25 A	3	G3PB-225B-3H-VD DC12-24
				2	G3PB-225B-2H-VD DC12-24
			35 A	3	G3PB-235B-3H-VD DC12-24
				2	G3PB-235B-2H-VD DC12-24
			45 A	3	G3PB-245B-3H-VD DC12-24
				2	G3PB-245B-2H-VD DC12-24
			200 to 480 VAC	15 A	3
	2				G3PB-515B-2H-VD DC12-24
	25 A			3	G3PB-525B-3H-VD DC12-24
				2	G3PB-525B-2H-VD DC12-24
	35 A			3	G3PB-535B-3H-VD DC12-24
				2	G3PB-535B-2H-VD DC12-24
	45 A			3	G3PB-545B-3H-VD DC12-24
				2	G3PB-545B-2H-VD DC12-24

**Note:** The applicable load current depends on the heat sink that is connected and the ambient temperature. For details, refer to *Load Current vs. Ambient Temperature* in *Engineering Data* on page 5.

# Specifications

## ■ Ratings (at an Ambient Temperature of 25°C)

### Operating Circuit (Common)

Item	Common
Rated voltage	12 to 24 VDC
Operating voltage range	9.6 to 30 VDC
Rated input current (Impedance)	10 mA max. (at 24 VDC)
Must operate voltage	9.6 VDC max.
Must release voltage	1 VDC min.
Insulation method	Phototriac coupler
Operation indicator	Yellow LED

### Main Circuit of Models with Built-in Heat Sinks

Item	Model	G3PB-215B-3N-VD	G3PB-215B-2N-VD	G3PB-225B-3N-VD	G3PB-225B-2N-VD	G3PB-235B-3N-VD	G3PB-235B-2N-VD	G3PB-245B-3N-VD	G3PB-245B-2N-VD	G3PB-515B-3N-VD	G3PB-515B-2N-VD	G3PB-525B-3N-VD	G3PB-525B-2N-VD	G3PB-535B-3N-VD	G3PB-535B-2N-VD	G3PB-545B-3N-VD	G3PB-545B-2N-VD	
Rated load voltage		100 to 240 VAC								200 to 480 VAC								
Load voltage range		75 to 264 VAC								180 to 528 VAC								
Applicable load current (See note 1.)		15 A (at 40°C)	25 A (at 40°C)	35 A (at 25°C)	45 A (at 25°C)	15 A (at 40°C)	25 A (at 40°C)	35 A (at 25°C)	45 A (at 25°C)	15 A (at 40°C)	25 A (at 40°C)	35 A (at 25°C)	45 A (at 25°C)	15 A (at 40°C)	25 A (at 40°C)	35 A (at 25°C)	45 A (at 25°C)	
Minimum load current		0.2 A				0.5 A												
Inrush current resistance (peak value)		150 A (60 Hz, 1 cycle)	220 A (60 Hz, 1 cycle)	440 A (60 Hz, 1 cycle)				220 A (60 Hz, 1 cycle)				440 A (60 Hz, 1 cycle)						
Permissible I <sup>2</sup> t (half 60-Hz wave)		121 A <sup>2</sup> s	260 A <sup>2</sup> s	1260 A <sup>2</sup> s				260 A <sup>2</sup> s				1260 A <sup>2</sup> s						
Applicable load (resistive load, AC1) (See note 2.)		5.1 kW max. (at 200 VAC)	8.6 kW max. (at 200 VAC)	12.1 kW max. (at 200 VAC)	15.5 kW max. (at 200 VAC)	12.5 kW max. (at 480 VAC)	20.7 kW max. (at 480 VAC)	29.0 kW max. (at 480 VAC)	37.4 kW max. (at 480 VAC)	12.5 kW max. (at 480 VAC)	20.7 kW max. (at 480 VAC)	29.0 kW max. (at 480 VAC)	37.4 kW max. (at 480 VAC)	12.5 kW max. (at 480 VAC)	20.7 kW max. (at 480 VAC)	29.0 kW max. (at 480 VAC)	37.4 kW max. (at 480 VAC)	

**Note:** 1. The applicable load current depends on the ambient temperature. For details, refer to *Load Current vs. Ambient Temperature* in *Engineering Data* on page 5.

2. Applicable Load

Use the following formula to calculate the maximum total capacity of a heater load for a three-phase balanced load with delta connections.

Maximum load capacity = Load current × Load voltage ×  $\sqrt{3}$

Example: 15 A × 200 V ×  $\sqrt{3}$  = 5.196 W ≅ 5.1 kW

Example: 15 A × 400 V ×  $\sqrt{3}$  = 10.392 W ≅ 10.3 kW

### Main Circuit of Models with Externally Attached Heat Sinks

Item	Model	G3PB-215B-3H-VD	G3PB-215B-2H-VD	G3PB-225B-3H-VD	G3PB-225B-2H-VD	G3PB-235B-3H-VD	G3PB-235B-2H-VD	G3PB-245B-3H-VD	G3PB-245B-2H-VD	G3PB-515B-3H-VD	G3PB-515B-2H-VD	G3PB-525B-3H-VD	G3PB-525B-2H-VD	G3PB-535B-3H-VD	G3PB-535B-2H-VD	G3PB-545B-3H-VD	G3PB-545B-2H-VD	
Rated load voltage		100 to 240 VAC								200 to 480 VAC								
Load voltage range		75 to 264 VAC								180 to 528 VAC								
Applicable load current (See note.)		15 A (at 40°C)	25 A (at 40°C)	35 A (at 25°C)	45 A (at 25°C)	15 A (at 40°C)	25 A (at 40°C)	35 A (at 25°C)	45 A (at 25°C)	15 A (at 40°C)	25 A (at 40°C)	35 A (at 25°C)	45 A (at 25°C)	15 A (at 40°C)	25 A (at 40°C)	35 A (at 25°C)	45 A (at 25°C)	
Minimum load current		0.2 A				0.5 A												
Inrush current resistance (peak value)		150 A (60 Hz, 1 cycle)	220 A (60 Hz, 1 cycle)	440 A (60 Hz, 1 cycle)				220 A (60 Hz, 1 cycle)				440 A (60 Hz, 1 cycle)						
Permissible I <sup>2</sup> t (half 60-Hz wave)		121 A <sup>2</sup> s	260 A <sup>2</sup> s	1,260 A <sup>2</sup> s				260 A <sup>2</sup> s				1,260 A <sup>2</sup> s						
Applicable load (resistive load, AC1)		Refer to <i>Engineering Data</i> on page 5.																

**Note:** The applicable load current depends on the heat sink that is connected and the ambient temperature. For details, refer to *Load Current vs. Ambient Temperature* in *Engineering Data* on page 5.

## ■ Characteristics

### Models with Built-in Heat Sinks

Item	G3PB-215B-3N-VD	G3PB-215B-2N-VD	G3PB-225B-3N-VD	G3PB-225B-2N-VD	G3PB-235B-3N-VD	G3PB-235B-2N-VD	G3PB-245B-3N-VD	G3PB-245B-2N-VD	G3PB-515B-3N-VD	G3PB-515B-2N-VD	G3PB-525B-3N-VD	G3PB-525B-2N-VD	G3PB-535B-3N-VD	G3PB-535B-2N-VD	G3PB-545B-3N-VD	G3PB-545B-2N-VD
<b>Operate time</b>	1/2 of load power source cycle + 1 ms max.															
<b>Release time</b>	1/2 of load power source cycle + 1 ms max.															
<b>Output ON voltage drop</b>	1.6 V (RMS) max.								1.8 V (RMS) max.							
<b>Leakage current (See note.)</b>	10 mA (at 200 VAC)								20 mA (at 480 VAC)							
<b>Insulation resistance</b>	100 MΩ min. (at 500 VDC)															
<b>Dielectric strength</b>	2,500 VAC, 50/60 Hz for 1 min															
<b>Vibration resistance</b>	Destruction: 10 to 55 to 10 Hz, 0.375-mm single amplitude (0.75-mm double amplitude) (Mounted to DIN track)															
<b>Shock resistance</b>	Destruction: 294 m/s <sup>2</sup> (98 m/s <sup>2</sup> with reverse mounting)															
<b>Ambient operating temperature</b>	Operating: -30°C to 80°C (with no icing or condensation) Storage: -30°C to 100°C (with no icing or condensation)															
<b>Ambient operating humidity</b>	Operating: 45% to 85%															
<b>Weight</b>	Approx. 1.25 kg	Ap-prox. 1.45 kg	Ap-prox. 1.25 kg	Ap-prox. 1.65 kg	Ap-prox. 1.45 kg	Ap-prox. 2.0 kg	Ap-prox. 1.65 kg	Approx. 1.25 kg	Ap-prox. 1.45 kg	Ap-prox. 1.25 kg	Ap-prox. 1.65 kg	Ap-prox. 1.45 kg	Ap-prox. 2.0 kg	Ap-prox. 1.65 kg		
<b>Certified standards</b>	UL508, CSA22.2 No. 14, EN60947-4-3 (IEC947-4-3); Certified by VDE (From April 2001)															
<b>EMC</b>	Emission: EN55011 Group 1 Class B Immunity: EN61000-6-2															

**Note:** The leakage current of phase S will be approximately  $\sqrt{3}$  times larger if the 2-element model is applied.

### Models with Externally Attached Heat Sinks

Model Item	G3PB-215B-3H-VD	G3PB-215B-2H-VD	G3PB-225B-3H-VD	G3PB-225B-2HVD	G3PB-235B-3H-VD	G3PB-235B-2H-VD	G3PB-245B-3H-VD	G3PB-245B-2H-VD	G3PB-515B-3H-VD	G3PB-515B-2H-VD	G3PB-525B-3H-VD	G3PB-525B-2H-VD	G3PB-535B-3H-VD	G3PB-535B-2H-VD	G3PB-545B-3H-VD	G3PB-545B-2H-VD
<b>Operate time</b>	1/2 of load power source cycle + 1 ms max.															
<b>Release time</b>	1/2 of load power source cycle + 1 ms max.															
<b>Output ON voltage drop</b>	1.6 V (RMS) max.								1.8 V (RMS) max.							
<b>Leakage current (See note.)</b>	10 mA (at 200 VAC)								20 mA (at 480 VAC)							
<b>Insulation resistance</b>	100 MΩ min. (at 500 VDC)															
<b>Dielectric strength</b>	2,500 VAC, 50/60 Hz for 1 min															
<b>Vibration resistance</b>	Destruction: 10 to 55 to 10 Hz, 0.375-mm single amplitude (0.75-mm double amplitude)															
<b>Shock resistance</b>	Destruction: 294 m/s <sup>2</sup> (98 m/s <sup>2</sup> with reverse mounting)															
<b>Storage temperature</b>	-30°C to 100°C (with no icing or condensation)															
<b>Ambient operating temperature</b>	-30°C to 80°C (with no icing or condensation)															
<b>Ambient storage humidity</b>	45% to 85%															
<b>Weight</b>	Approx. 300 g															

**Note:** The leakage current of phase S will be approximately  $\sqrt{3}$  times larger if the 2-element model is used.

# Engineering Data

## Load Current vs. Ambient Temperature

### Models with Built-in Heat Sinks

**G3PB-215B-3N-VD**  
**G3PB-215B-2N-VD**

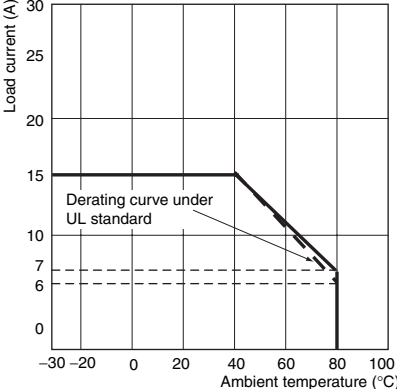

**G3PB-225B-3N-VD**  
**G3PB-225B-2N-VD**

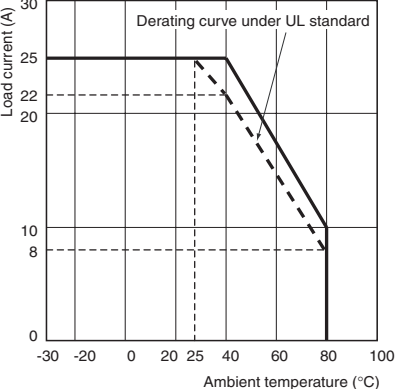

**G3PB-235B-3N-VD**  
**G3PB-235B-2N-VD**

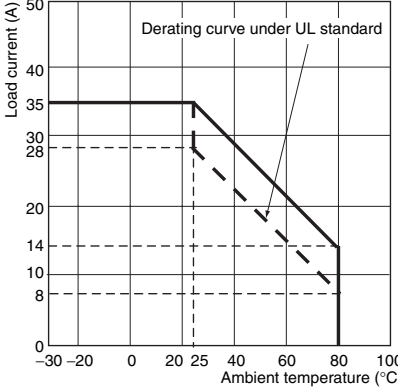

Note: 1. Please use proper ventilation and cooling.  
 2. Please note that the derating curve above 28 A is applicable under the UL standard only with forced air cooling by fan.

**G3PB-245B-3N-VD**  
**G3PB-245B-2N-VD**

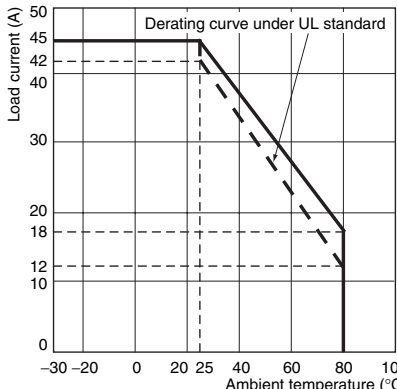

Note: 1. Please use proper ventilation and cooling.  
 2. Please note that the derating curve above 42 A is applicable under the UL standard only with forced air cooling by fan.

**G3PB-515B-3N-VD**  
**G3PB-515B-2N-VD**

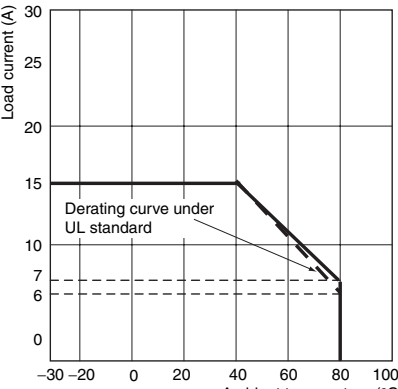

**G3PB-525B-3N-VD**  
**G3PB-525B-2N-VD**

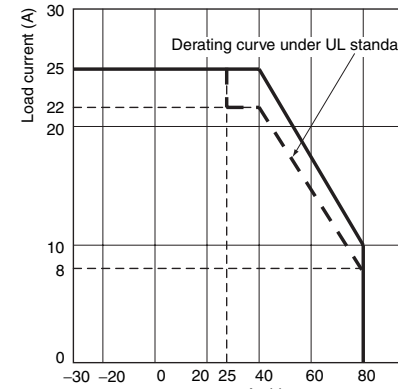

Note: 1. Please use proper ventilation and cooling.  
 2. Please note that the derating curve above 22 A is applicable under the UL standard only with forced air cooling by fan.

**G3PB-535B-3N-VD**  
**G3PB-535B-2N-VD**

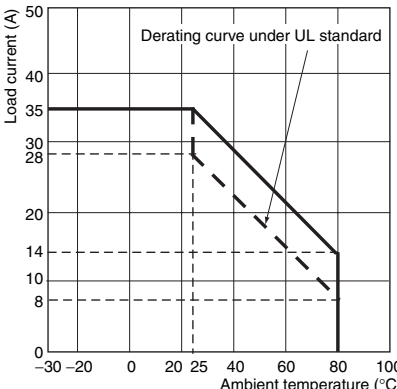

Note: 1. Please use proper ventilation and cooling.  
 2. Please note that the derating curve above 28 A is applicable under the UL standard only with forced air cooling by fan.

**G3PB-545B-3N-VD**  
**G3PB-545B-2N-VD**

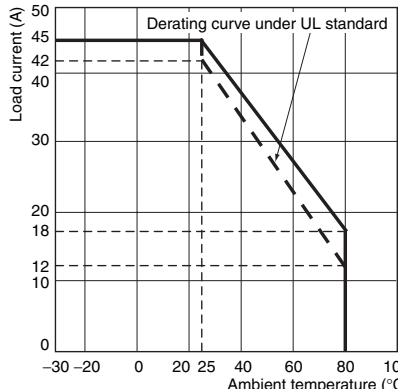

Note: 1. Please use proper ventilation and cooling.  
 2. Please note that the derating curve above 42 A is applicable under the UL standard only with forced air cooling by fan.

## Load Current vs. Ambient Temperature

### Models without Built-in Heat Sinks

G3PB-215B-3H(-2H)-VD  
 G3PB-225B-3H(-2H)-VD  
 G3PB-515B-3H(-2H)-VD  
 G3PB-525B-3H(-2H)-VD

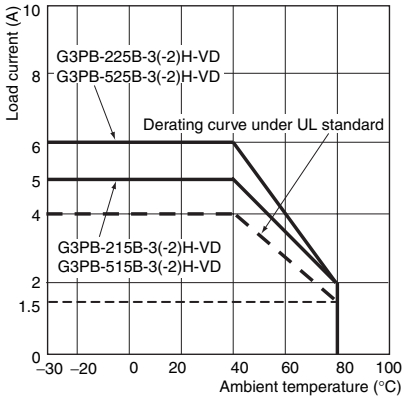

Note: Please use proper ventilation and cooling.

G3PB-235B-3H(-2H)-VD  
 G3PB-245B-3H(-2H)-VD  
 G3PB-535B-3H(-2H)-VD  
 G3PB-545B-3H(-2H)-VD

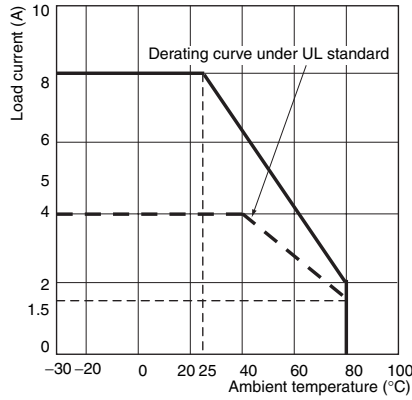

Note: Please use proper ventilation and cooling.

## Input Voltage vs. Input Current and Input Voltage vs. Input Impedance

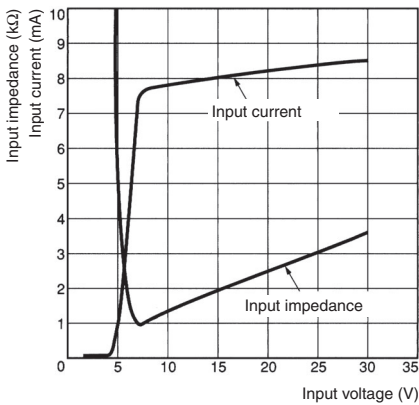

## One Cycle Surge Current: Non-repetitive

Note: Keep the inrush current to half the rated value if it occurs repetitively.

G3PB-215B-3N/3H-VD  
 G3PB-215B-2N/2H-VD

G3PB-225B-3N/3H-VD  
 G3PB-225B-2N/2H-VD  
 G3PB-515B-3N/3H-VD  
 G3PB-515B-2N/2H-VD  
 G3PB-525B-3N/3H-VD  
 G3PB-525B-2N/2H-VD

G3PB-235B-3N/3H-VD  
 G3PB-235B-2N/2H-VD  
 G3PB-245B-3N/3H-VD  
 G3PB-245B-2N/2H-VD  
 G3PB-535B-3N/3H-VD  
 G3PB-535B-2N/2H-VD  
 G3PB-545B-3N/3H-VD  
 G3PB-545B-2N/2H-VD

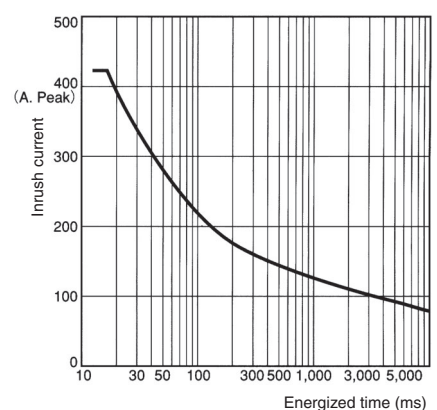
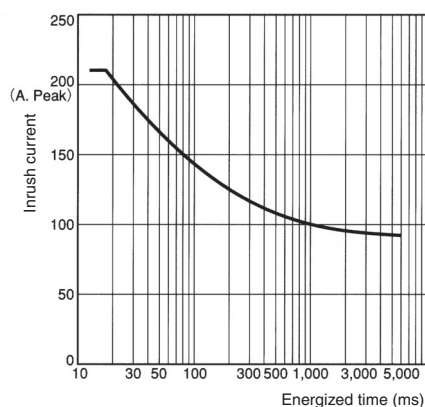
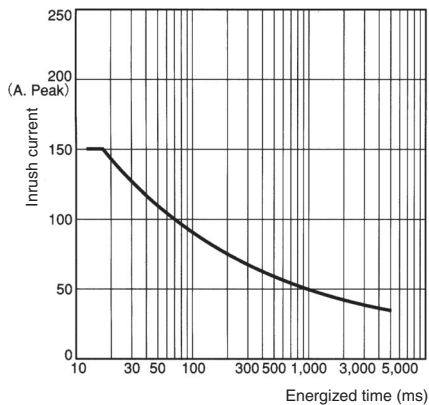

# Dimensions

Note: All units are in millimeters unless otherwise indicated.

- G3PB-215B-3N-VD
- G3PB-215B-2N-VD
- G3PB-225B-2N-VD
- G3PB-515B-3N-VD
- G3PB-515B-2N-VD
- G3PB-525B-2N-VD

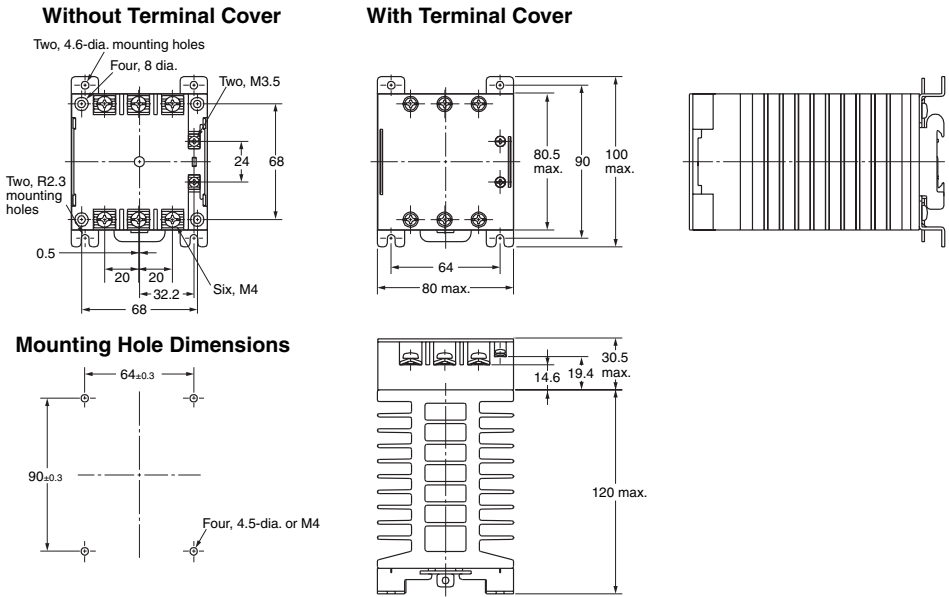
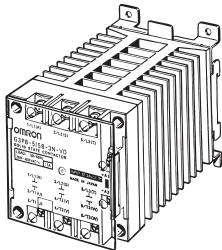

**Terminal Arrangement/Internal Connections**

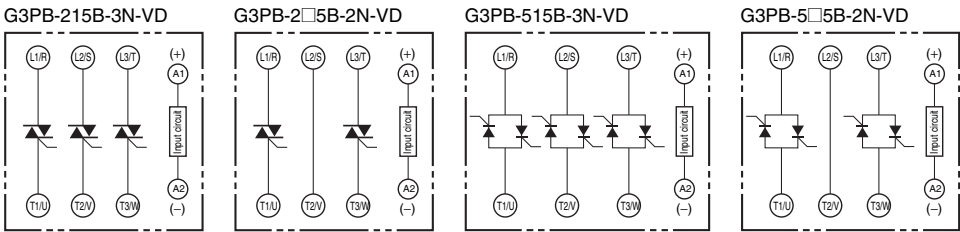

- G3PB-225B-3N-VD
- G3PB-235B-2N-VD
- G3PB-525B-3N-VD
- G3PB-535B-2N-VD

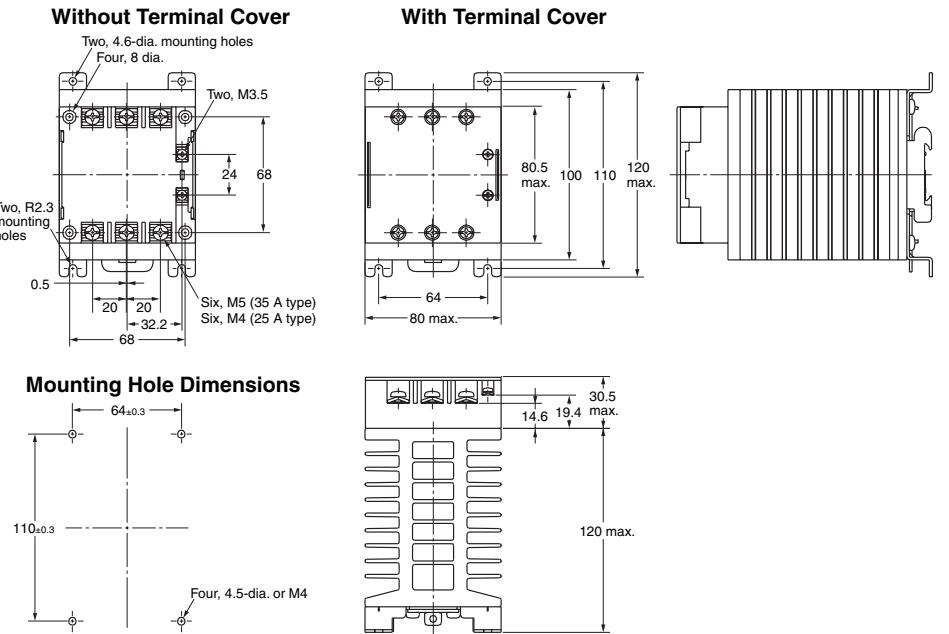
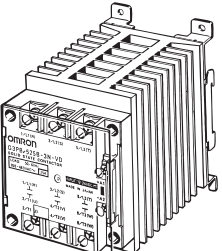

**Terminal Arrangement/Internal Connections**

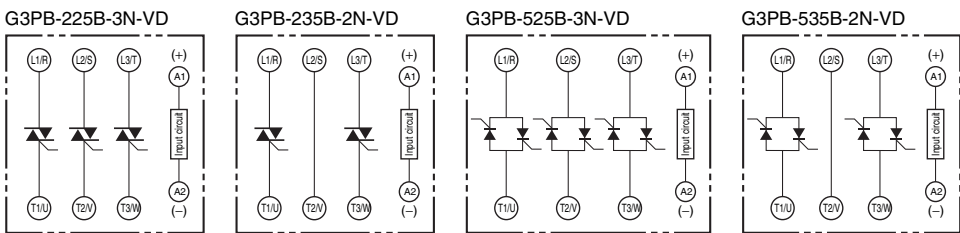

G3PB-235B-3N-VD  
 G3PB-245B-2N-VD  
 G3PB-535B-3N-VD  
 G3PB-545B-2N-VD

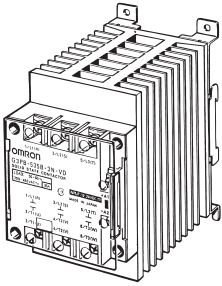

### Without Terminal Cover

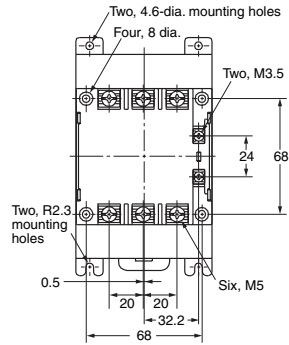

### With Terminal Cover

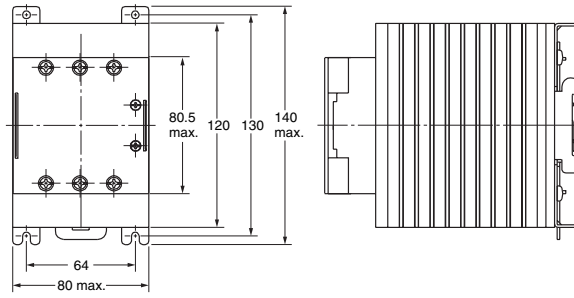

### Mounting Hole Dimensions

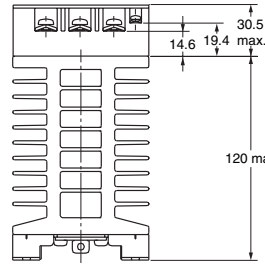
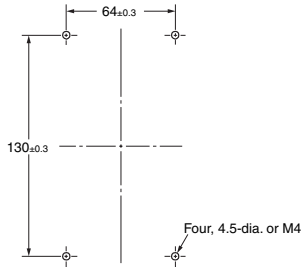

### Terminal Arrangement/Internal Connections

G3PB-235B-3N-VD

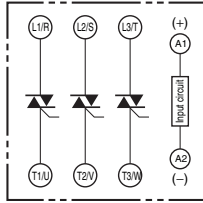

G3PB-245B-2N-VD

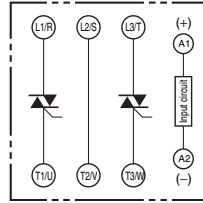

G3PB-535B-3N-VD

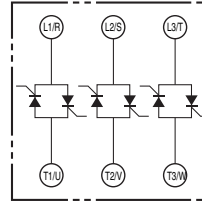

G3PB-545B-2N-VD

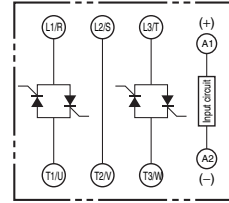

G3PB-245B-3N-VD  
 G3PB-545B-3N-VD

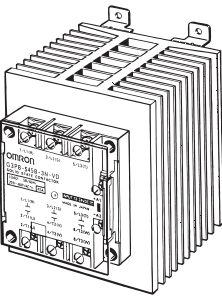

### Without Terminal Cover

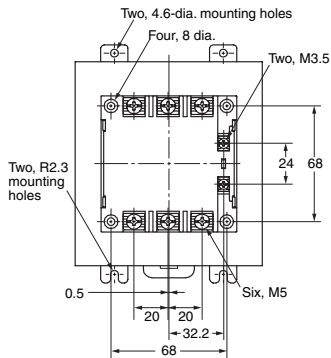

### With Terminal Cover

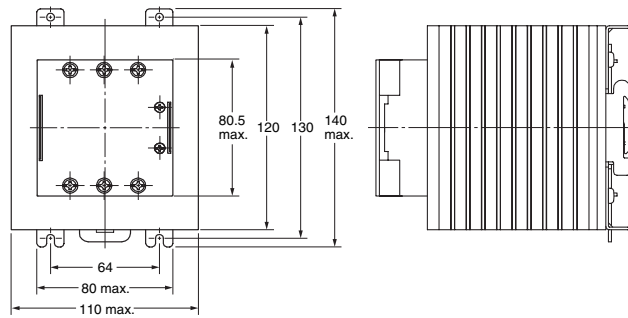

### Mounting Hole Dimensions

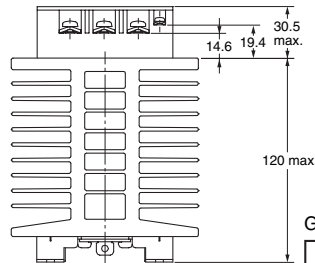
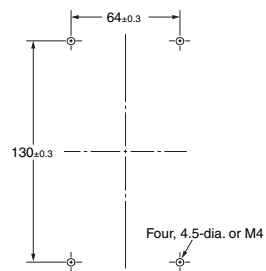

### Terminal Arrangement/Internal Connections

G3PB-245B-3N-VD

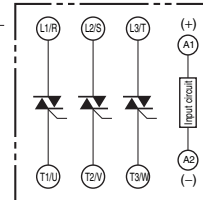

G3PB-545B-3N-VD

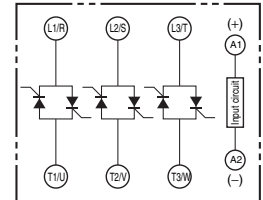



ALL DIMENSIONS SHOWN ARE IN MILLIMETERS.  
To convert millimeters into inches, multiply by 0.03937. To convert grams into ounces, multiply by 0.03527.

In the interest of product improvement, specifications are subject to change without notice.

## Read and Understand This Catalog

Please read and understand this catalog before purchasing the products. Please consult your OMRON representative if you have any questions or comments.

## Warranty and Limitations of Liability

### WARRANTY

OMRON's exclusive warranty is that the products are free from defects in materials and workmanship for a period of one year (or other period if specified) from date of sale by OMRON.

OMRON MAKES NO WARRANTY OR REPRESENTATION, EXPRESS OR IMPLIED, REGARDING NON-INFRINGEMENT, MERCHANTABILITY, OR FITNESS FOR PARTICULAR PURPOSE OF THE PRODUCTS. ANY BUYER OR USER ACKNOWLEDGES THAT THE BUYER OR USER ALONE HAS DETERMINED THAT THE PRODUCTS WILL SUITABLY MEET THE REQUIREMENTS OF THEIR INTENDED USE. OMRON DISCLAIMS ALL OTHER WARRANTIES, EXPRESS OR IMPLIED.

### LIMITATIONS OF LIABILITY

OMRON SHALL NOT BE RESPONSIBLE FOR SPECIAL, INDIRECT, OR CONSEQUENTIAL DAMAGES, LOSS OF PROFITS OR COMMERCIAL LOSS IN ANY WAY CONNECTED WITH THE PRODUCTS, WHETHER SUCH CLAIM IS BASED ON CONTRACT, WARRANTY, NEGLIGENCE, OR STRICT LIABILITY.

In no event shall the responsibility of OMRON for any act exceed the individual price of the product on which liability is asserted.

IN NO EVENT SHALL OMRON BE RESPONSIBLE FOR WARRANTY, REPAIR, OR OTHER CLAIMS REGARDING THE PRODUCTS UNLESS OMRON'S ANALYSIS CONFIRMS THAT THE PRODUCTS WERE PROPERLY HANDLED, STORED, INSTALLED, AND MAINTAINED AND NOT SUBJECT TO CONTAMINATION, ABUSE, MISUSE, OR INAPPROPRIATE MODIFICATION OR REPAIR.

## Application Considerations

### SUITABILITY FOR USE

OMRON shall not be responsible for conformity with any standards, codes, or regulations that apply to the combination of products in the customer's application or use of the products.

At the customer's request, OMRON will provide applicable third party certification documents identifying ratings and limitations of use that apply to the products. This information by itself is not sufficient for a complete determination of the suitability of the products in combination with the end product, machine, system, or other application or use.

The following are some examples of applications for which particular attention must be given. This is not intended to be an exhaustive list of all possible uses of the products, nor is it intended to imply that the uses listed may be suitable for the products:

- Outdoor use, uses involving potential chemical contamination or electrical interference, or conditions or uses not described in this catalog.
- Nuclear energy control systems, combustion systems, railroad systems, aviation systems, medical equipment, amusement machines, vehicles, safety equipment, and installations subject to separate industry or government regulations.
- Systems, machines, and equipment that could present a risk to life or property.

Please know and observe all prohibitions of use applicable to the products.

NEVER USE THE PRODUCTS FOR AN APPLICATION INVOLVING SERIOUS RISK TO LIFE OR PROPERTY WITHOUT ENSURING THAT THE SYSTEM AS A WHOLE HAS BEEN DESIGNED TO ADDRESS THE RISKS, AND THAT THE OMRON PRODUCTS ARE PROPERLY RATED AND INSTALLED FOR THE INTENDED USE WITHIN THE OVERALL EQUIPMENT OR SYSTEM.

### PROGRAMMABLE PRODUCTS

OMRON shall not be responsible for the user's programming of a programmable product, or any consequence thereof.

## Disclaimers

### CHANGE IN SPECIFICATIONS

Product specifications and accessories may be changed at any time based on improvements and other reasons.

It is our practice to change model numbers when published ratings or features are changed, or when significant construction changes are made. However, some specifications of the products may be changed without any notice. When in doubt, special model numbers may be assigned to fix or establish key specifications for your application on your request. Please consult with your OMRON representative at any time to confirm actual specifications of purchased products.

### DIMENSIONS AND WEIGHTS

Dimensions and weights are nominal and are not to be used for manufacturing purposes, even when tolerances are shown.

### PERFORMANCE DATA

Performance data given in this catalog is provided as a guide for the user in determining suitability and does not constitute a warranty. It may represent the result of OMRON's test conditions, and the users must correlate it to actual application requirements. Actual performance is subject to the OMRON Warranty and Limitations of Liability.

### ERRORS AND OMISSIONS

The information in this document has been carefully checked and is believed to be accurate; however, no responsibility is assumed for clerical, typographical, or proofreading errors, or omissions.

2008.11

In the interest of product improvement, specifications are subject to change without notice.

**OMRON Corporation**  
Industrial Automation Company

<http://www.ia.omron.com/>

(c)Copyright OMRON Corporation 2008 All Right Reserved.