



# Bridgelux® H15 Array

Product Data Sheet DS83



BXRH-27x8000 | 30x8000 | 35x800X | 40x8000

# Introduction

H Series



H Series™, an ultra-high lumen density COB product line, is designed for high intensity spotlights used in commercial and retail settings. H series arrays offer industry leading color over angle uniformity, and replace ceramic metal halide lamps by providing equal or greater center beam candle power at lower power and at greater lifetimes. Their tight beam control and exceptional quality of light is well suited for demanding directional spot applications.

H Series LEDs are available in a variety of CCT and CRI combinations, including Décor Series Class A, a revolutionary advancement in lighting designed to match how humans perceive and prefer light, and Décor Series Ultra. Décor Series Ultra offers a high CRI of 97 and emphasizes reds and color tones to which the human eye is most receptive. Typical applications for H Series LEDs include but are not limited to commercial and residential down lights, accent, spot & track lights.

## Features

- Market-leading flux density
- Center beam candle power comparable to ceramic metal halides
- Uniform, high-quality illumination
- Small point LED source
- Minimum 80, 90, 95 CRI and Class A options
- ENERGY STAR®/ANSI compliant color binning structure with 2SDCM and 3SDCM options

## Benefits

- Enhanced optical control
- Clean, consistent white light without pixelation
- High quality, true color reproduction
- Significantly reduced thermal resistance and increased operating conditions
- Lower operating costs
- Reduced maintenance costs
- Environmentally friendly, no disposal issues

# Contents

Product Feature Map	2
Product Nomenclature	2
Product Selection Guide	3
Performance at Commonly Used Drive Currents	4
Electrical Characteristics	6
Absolute Maximum Ratings	7
Performance Curves	8
Typical Radiation Pattern	12
Typical Color Spectrum	13
Mechanical Dimensions	14
Color Binning Information	15
Packaging and Labeling	16
Design Resources	17
Precautions	17
Disclaimers	17
About Bridgelux	18

---



# Product Selection Guide

The following product configurations are available:

**Table 1:** Selection Guide, Pulsed Measurement Data ( $T_j = T_c = 25^\circ\text{C}$ )

Part Number	Nominal CCT <sup>1</sup> (K)	CRI <sup>2</sup>	Nominal Drive Current (mA)	Typical Pulsed Flux <sup>3,4,5</sup> $T_c = 25^\circ\text{C}$ (lm)	Minimum Pulsed Flux <sup>5,6</sup> $T_c = 25^\circ\text{C}$ (lm)	Typical $V_f$ (V)	Typical Power (W)	Typical Efficacy (lm/W) <sup>7</sup>
BXRH-27E8000-J-23	2700	80	2500	8693	7476	36.6	91.5	95
BXRH-27G8000-J-23	2700	90	2500	7229	6217	36.6	91.5	79
BXRH-27H8000-J-23	2700	97	2500	6954	5980	36.6	91.5	76
BXRH-30E8000-J-23	3000	80	2500	9150	7869	36.6	91.5	100
BXRH-30G8000-J-23	3000	90	2500	7686	6610	36.6	91.5	84
BXRH-30H8000-J-23	3000	97	2500	7229	6217	36.6	91.5	79
BXRH-35A8001-J-23 <sup>8</sup>	3500	93	2500	7686	6610	36.6	91.5	84
BXRH-35G8000-J-23	3500	90	2500	7869	6767	36.6	91.5	86
BXRH-40E8000-J-23	4000	80	2500	9699	8341	36.6	91.5	106
BXRH-40G8000-J-23	4000	90	2500	8052	6925	36.6	91.5	88

**Table 2:** Selection Guide, Stabilized DC Performance ( $T_c = 85^\circ\text{C}$ )<sup>9,10</sup>

Part Number	Nominal CCT <sup>1</sup> (K)	CRI <sup>2</sup>	Nominal Drive Current (mA)	Typical DC Flux <sup>4,5</sup> $T_c = 85^\circ\text{C}$ (lm)	Minimum DC Flux <sup>9,11</sup> $T_c = 85^\circ\text{C}$ (lm)	Typical $V_f$ (V)	Typical Power (W)	Typical Efficacy (lm/W)
BXRH-27E8000-J-23	2700	80	2500	7562	6504	35.1	87.8	86
BXRH-27G8000-J-23	2700	90	2500	6289	5408	35.1	87.8	72
BXRH-27H8000-J-23	2700	97	2500	6050	5203	35.1	87.8	69
BXRH-30E8000-J-23	3000	80	2500	7961	6846	35.1	87.8	91
BXRH-30G8000-J-23	3000	90	2500	6687	5751	35.1	87.8	76
BXRH-30H8000-J-23	3000	97	2500	6289	5408	35.1	87.8	72
BXRH-35A8001-J-23	3500	93	2500	6687	5751	35.1	87.8	76
BXRH-35G8000-J-23	3500	90	2500	6846	5888	35.1	87.8	78
BXRH-40E8000-J-23	4000	80	2500	8438	7257	35.1	87.8	96
BXRH-40G8000-J-23	4000	90	2500	7005	6025	35.1	87.8	80

Notes for Tables 1 & 2:

- Nominal CCT as defined by ANSI C78.377-2011.
- CRI values are typical for Décor Series Ultra and Class A color points and minimums for all other color points. Minimum Rg value for 80 CRI products is 0, minimum Rg value for 90 CRI products is 50.
- Products tested under pulsed condition (10 ms pulse width) at nominal test current where  $T_j$  (junction temperature) =  $T_c$  (case temperature) =  $25^\circ\text{C}$ .
- Typical performance values are provided as reference only and are not a guarantee of performance.
- Bridgelux maintains a  $\pm 7\%$  tolerance on flux measurements.
- Minimum flux values at the nominal test current are guaranteed by 100% production testing.
- Typical efficacy is a function of lumen output. See example in Figure. 2.
- Class A products are a revolutionary advancement in lighting designed to match how humans perceive and prefer light. Nominal CCT is defined by the Lighting Research Center's Class A definition. The center of the Class A color bin is on the corresponding isothermal line.
- Typical stabilized DC performance values are provided as reference only and are not a guarantee of performance.
- Typical performance is estimated based on operation under DC (direct current) with LED array mounted onto a heat sink with thermal interface material and the case temperature maintained at  $85^\circ\text{C}$ . Values may vary depending on the thermal design of the luminaire and/or the exposed environment to which the product is subjected.
- Minimum flux values at elevated temperatures are provided for reference only and are not guaranteed by 100% production testing. Values may vary depending on the thermal design of the luminaire and/or the exposed environment to which the product is subjected.

# Performance at Commonly Used Drive Currents

H Series LED arrays are tested to the specifications shown using the nominal drive currents in Table 1. H Series arrays may also be driven at other drive currents depending on specific application design requirements. The performance at any drive current can be derived from the efficacy vs. flux characteristics in Figure 2, the current vs. voltage characteristics shown in Figure 3 and the flux vs. current characteristics shown in Figure 4. The performance at commonly used drive currents is summarized in Table 3.

**Table 3:** Performance at Commonly Used Drive Currents

Part Number	CRI	Drive Current <sup>1</sup> (mA)	Typical $V_f$ $T_c = 25^\circ\text{C}$ (V)	Typical Power $T_c = 25^\circ\text{C}$ (W)	Typical Flux <sup>2</sup> $T_c = 25^\circ\text{C}$ (lm)	Typical DC Flux <sup>3</sup> $T_c = 85^\circ\text{C}$ (lm)	Typical Efficacy $T_c = 25^\circ\text{C}$ (lm/W)
BXRH-27E8000-J-23	80	1050	34.1	35.8	4065	3537	114
		1400	34.8	48.7	5254	4571	108
		2100	36.0	75.6	7494	6520	99
		<b>2500</b>	<b>36.6</b>	<b>91.5</b>	<b>8693</b>	<b>7562</b>	<b>95</b>
		3150	37.4	117.8	10512	9145	89
		3500	37.8	132.2	11426	9940	86
BXRH-27G8000-J-23	90	1050	34.1	35.8	3380	2941	94
		1400	34.8	48.7	4369	3801	90
		2100	36.0	75.6	6232	5422	82
		<b>2500</b>	<b>36.6</b>	<b>91.5</b>	<b>7229</b>	<b>6289</b>	<b>79</b>
		3150	37.4	117.8	8741	7605	74
		3500	37.8	132.2	9501	8266	72
BXRH-27H8000-J-23	97	1050	34.1	35.8	3252	2829	91
		1400	34.8	48.7	4203	3657	86
		2100	36.0	75.6	5996	5216	79
		<b>2500</b>	<b>36.6</b>	<b>91.5</b>	<b>6954</b>	<b>6050</b>	<b>76</b>
		3150	37.4	117.8	8409	7316	71
		3500	37.8	132.2	9141	7952	69
BXRH-30E8000-J-23	80	1050	34.1	35.8	4279	3723	120
		1400	34.8	48.7	5530	4812	114
		2100	36.0	75.6	7889	6863	104
		<b>2500</b>	<b>36.6</b>	<b>91.5</b>	<b>9150</b>	<b>7961</b>	<b>100</b>
		3150	37.4	117.8	11065	9626	94
		3500	37.8	132.2	12027	10464	91
BXRH-30G8000-J-23	90	1050	34.1	35.8	3594	3127	100
		1400	34.8	48.7	4646	4042	95
		2100	36.0	75.6	6627	5765	88
		<b>2500</b>	<b>36.6</b>	<b>91.5</b>	<b>7686</b>	<b>6687</b>	<b>84</b>
		3150	37.4	117.8	9295	8086	79
		3500	37.8	132.2	10103	8789	76

# Performance at Commonly Used Drive Currents

**Table 3:** Performance at Commonly Used Drive Currents

Part Number	CRI	Drive Current <sup>1</sup> (mA)	Typical $V_f$ $T_c = 25^\circ\text{C}$ (V)	Typical Power $T_c = 25^\circ\text{C}$ (W)	Typical Flux <sup>2</sup> $T_c = 25^\circ\text{C}$ (lm)	Typical DC Flux <sup>3</sup> $T_c = 85^\circ\text{C}$ (lm)	Typical Efficacy $T_c = 25^\circ\text{C}$ (lm/W)
BXRH-30H8000-J-23	97	1050	34.1	35.8	3380	2941	94
		1400	34.8	48.7	4369	3801	90
		2100	36.0	75.6	6232	5422	82
		<b>2500</b>	<b>36.6</b>	<b>91.5</b>	<b>7229</b>	<b>6289</b>	<b>79</b>
		3150	37.4	117.8	8741	7605	74
		3500	37.8	132.2	9501	8266	72
BXRH-35A8001-J-23	93	1050	34.1	35.8	3594	3127	100
		1400	34.8	48.7	4646	4042	95
		2100	36.0	75.6	6627	5765	88
		<b>2500</b>	<b>36.6</b>	<b>91.5</b>	<b>7686</b>	<b>6687</b>	<b>84</b>
		3150	37.4	117.8	9295	8086	79
		3500	37.8	132.2	10103	8789	76
BXRH-35G8000-J-23	90	1050	34.1	35.8	3680	3202	103
		1400	34.8	48.7	4756	4138	98
		2100	36.0	75.6	6784	5902	90
		<b>2500</b>	<b>36.6</b>	<b>91.5</b>	<b>7869</b>	<b>6846</b>	<b>86</b>
		3150	37.4	117.8	9516	8279	81
		3500	37.8	132.2	10343	8999	78
BXRH-40E8000-J-23	80	1050	34.1	35.8	4536	3946	127
		1400	34.8	48.7	5862	5100	120
		2100	36.0	75.6	8362	7275	111
		<b>2500</b>	<b>36.6</b>	<b>91.5</b>	<b>9699</b>	<b>8438</b>	<b>106</b>
		3150	37.4	117.8	11729	10204	100
		3500	37.8	132.2	12749	11091	96
BXRH-40G8000-J-23	90	1050	34.1	35.8	3765	3276	105
		1400	34.8	48.7	4867	4234	100
		2100	36.0	75.6	6942	6040	92
		<b>2500</b>	<b>36.6</b>	<b>91.5</b>	<b>8052</b>	<b>7005</b>	<b>88</b>
		3150	37.4	117.8	9737	8471	83
		3500	37.8	132.2	10584	9208	80

Notes for Table 3:

1. Alternate drive currents in Table 3 are provided for reference only and are not a guarantee of performance.
2. Bridgelux maintains a  $\pm 7\%$  tolerance on flux measurements.
3. Typical stabilized DC flux values at  $85^\circ\text{C}$  are provided as reference only and are not a guarantee of performance.

# Electrical Characteristics

**Table 4:** Electrical Characteristics

Part Number	Drive Current (mA)	Forward Voltage Pulsed, $T_c = 25^\circ\text{C}$ (V) <sup>1,2,3,4</sup>			Typical Coefficient of Forward Voltage <sup>5</sup> $\Delta V_f / \Delta T$ (mV/ $^\circ\text{C}$ )	Typical Thermal Resistance Junction to Case <sup>6,7</sup> $R_{j-c}$ (C/W)	Driver Selection Voltages <sup>8</sup> (V)	
		Minimum	Typical	Maximum			$V_f$ Min. Hot $T_c = 105^\circ\text{C}$ (V)	$V_f$ Max. Cold $T_c = -40^\circ\text{C}$ (V)
BXRH-xxx8000-J-2x	2500	33.9	36.6	39.3	-24.4	0.10	32.0	40.9
	3500	35.0	37.8	40.4	-24.4	0.10	33.1	42.0

Notes for Table 4:

- Parts are tested in pulsed conditions,  $T_c = 25^\circ\text{C}$ . Pulse width is 10 ms.
- Voltage minimum and maximum are provided for reference only and are not a guarantee of performance.
- Bridgelux maintains a tolerance of  $\pm 0.10$  V on forward voltage measurements.
- The working voltage designated for insulation is 150 V DC, according to safety testing per IEC 62031 standard.
- Typical coefficient of forward voltage tolerance is  $\pm 0.1$  mV for nominal current.
- Thermal resistance values are based from test data of a 3000 K 80 CRI product.
- Thermal resistance value was calculated using total electrical input power; optical power was not subtracted from input power. The thermal interface material used during testing is not included in the thermal resistance value.
- $V_f$  min hot and max cold values are provided as reference only and are not guaranteed. These values are provided to aid in driver design and selection over the operating range of the product.



# Absolute Maximum Ratings

**Table 5:** Absolute Maximum Ratings

Parameter	Maximum Rating
LED Junction Temperature (T <sub>j</sub> )	125°C
Storage Temperature	-40°C to +105°C
Operating Case Temperature <sup>1</sup> (T <sub>c</sub> )	105°C
Soldering Temperature <sup>2</sup>	350°C or lower for a maximum of 10 seconds
Maximum Drive Current <sup>3</sup>	3500 mA
LM-80 Maximum Drive Current <sup>4,5</sup>	3150 mA
Maximum Peak Pulsed Drive Current <sup>6</sup>	3770 mA
Maximum Reverse Voltage <sup>7</sup>	-60 V

Notes for Table 5:

1. For IEC 62717 requirement, please consult your Bridgelux sales representative.
2. Refer to Bridgelux Application Note AN81: Handling and Assembly of Bridgelux H Series Arrays.
3. H15 LED arrays can be operated above LM-80 maximum drive current, up to 3500 mA. Contact Bridgelux for details.
4. Lumen maintenance (L70) and lifetime predictions are valid for drive current and case temperature conditions used for LM-80 testing as included in the applicable LM-80 test report for these arrays. Contact your Bridgelux sales representatives for LM-80 report.
5. Arrays may be driven at higher currents. However, lumen maintenance may be reduced. Contact Bridgelux for details.
6. Bridgelux recommends a maximum duty cycle of 10% and pulse width of 20 ms when operating LED Arrays at maximum peak pulsed current specified. Maximum peak pulsed currents indicate values where LED Arrays can be driven without catastrophic failures.
7. Light emitting diodes are not designed to be driven in reverse voltage and will not produce light under this condition. Maximum rating provided for reference only.

# Performance Curves

The maximum allowable drive current for the H15 family of products is dependent on the operating case temperature. Please refer to the Product Feature Map (page 2) for the location of the T<sub>c</sub> measurement point.

**Figure 1: H15 Drive Current Derating Curve (T<sub>j</sub> = T<sub>c</sub> = 25°C)**

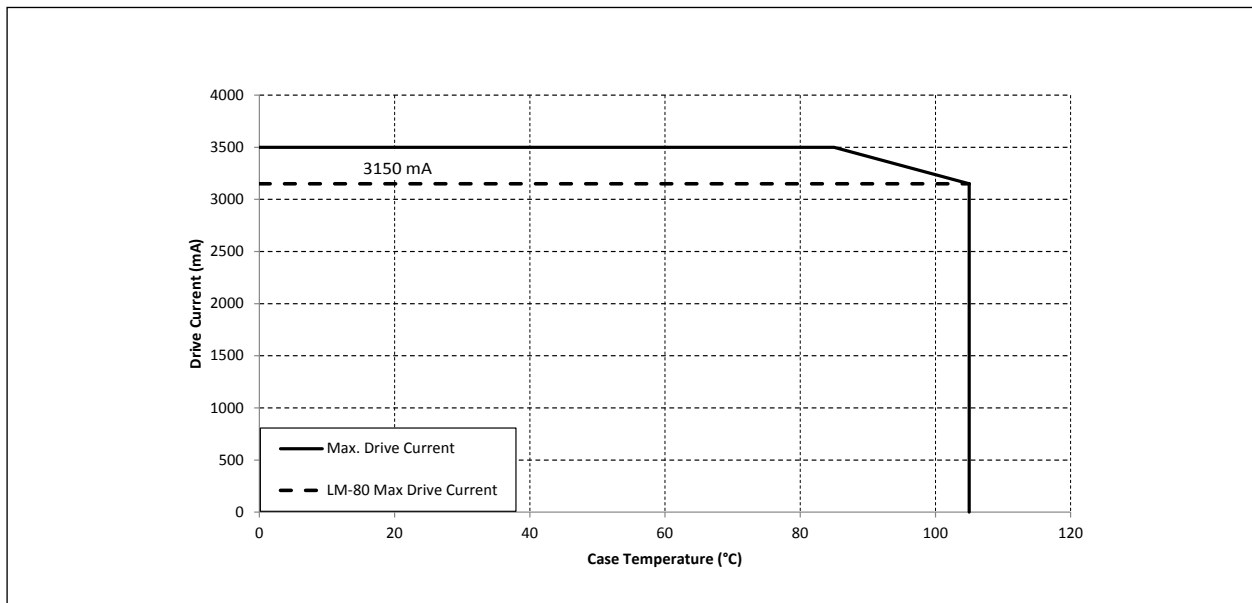

Notes for Figure 1:

1. LM-80 Max Drive Current must not be exceeded in order to meet LM-80 lifetime projections.
2. Lumen maintenance (L70) and lifetime predictions are valid for drive current and case temperature conditions used for LM-80 testing as included in the applicable LM-80 test report for these products. Contact your Bridgelux sales representative for LM-80 report.

# Performance Curves

Figure 2: Efficacy vs. Flux ( $T_j = T_c = 25^\circ\text{C}$ ; BXRH-30E8000-J-23)

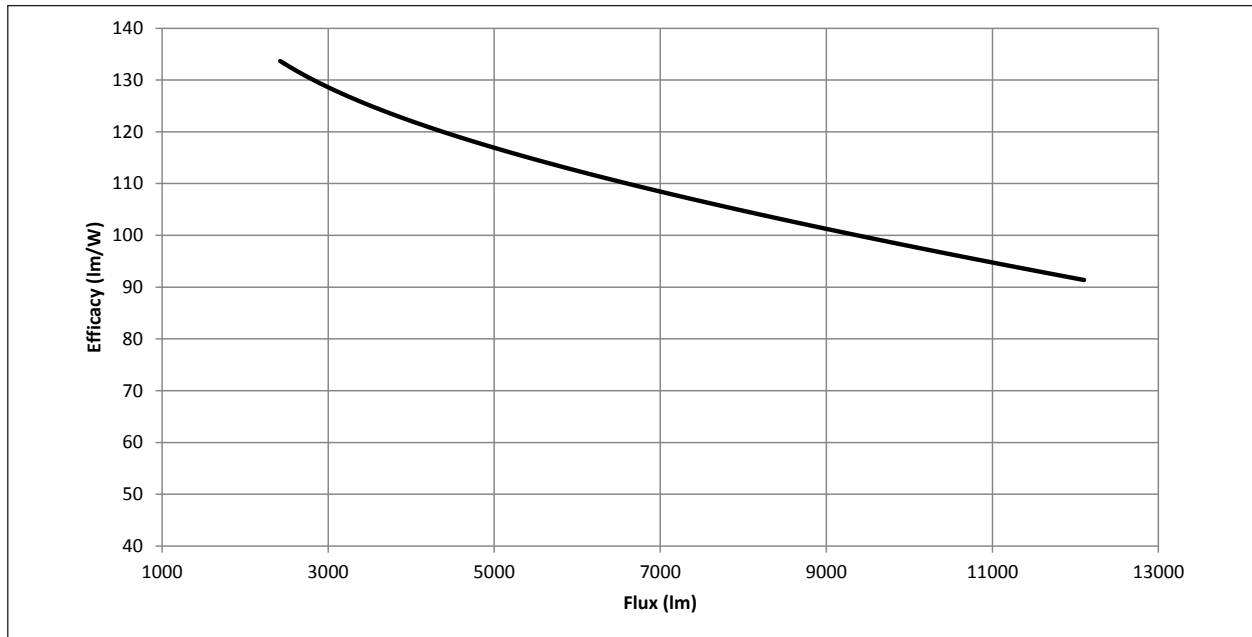

Note for Figure 2:

1. Light output of H Series LEDs span a wide lumen range. Typical efficacy is a function of lumen output.

Figure 3: Drive Current vs. Voltage ( $T_j = T_c = 25^\circ\text{C}$ )

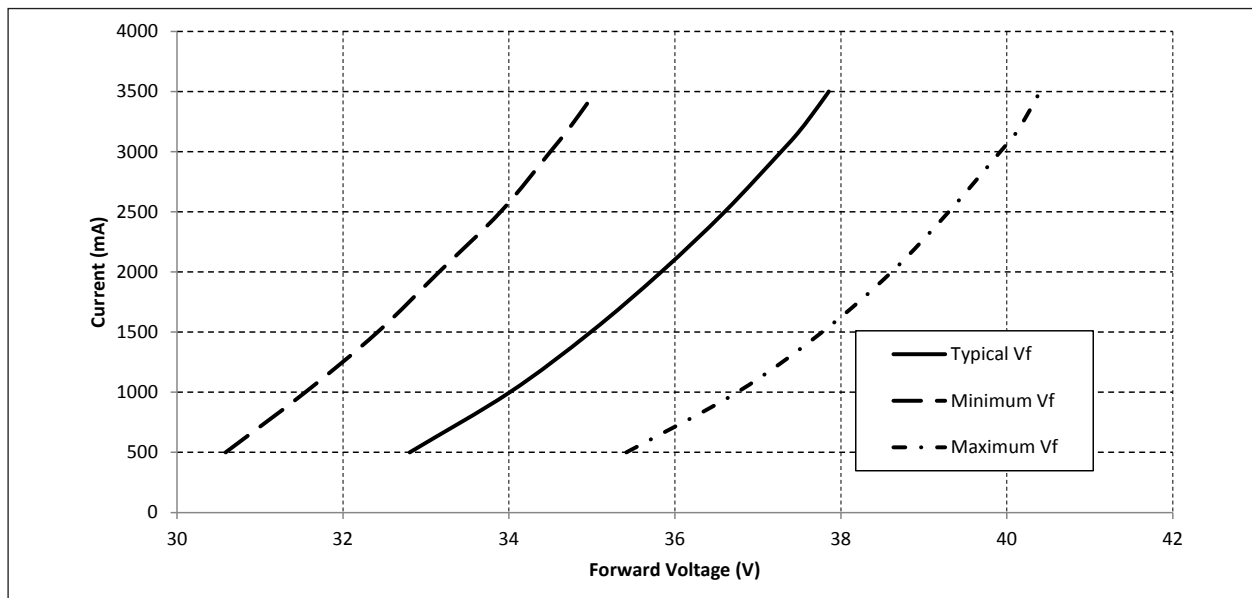

# Performance Curves

Figure 4: Typical Relative Luminous Flux vs. Drive Current ( $T_j = T_c = 25^\circ\text{C}$ )

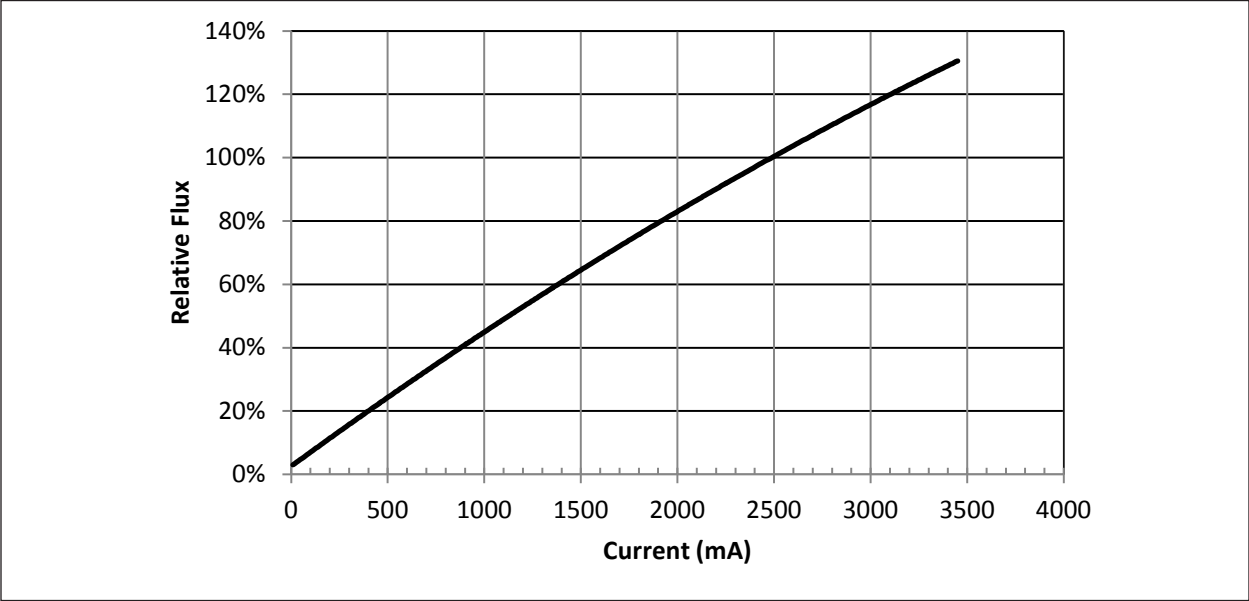

Note for Figure 4:

- 1. Bridgelux does not recommend driving high power LEDs at low currents. Doing so may produce unpredictable results. Pulse width modulation (PWM) is recommended for dimming effects.

Figure 5: Typical DC Flux vs. Case Temperature

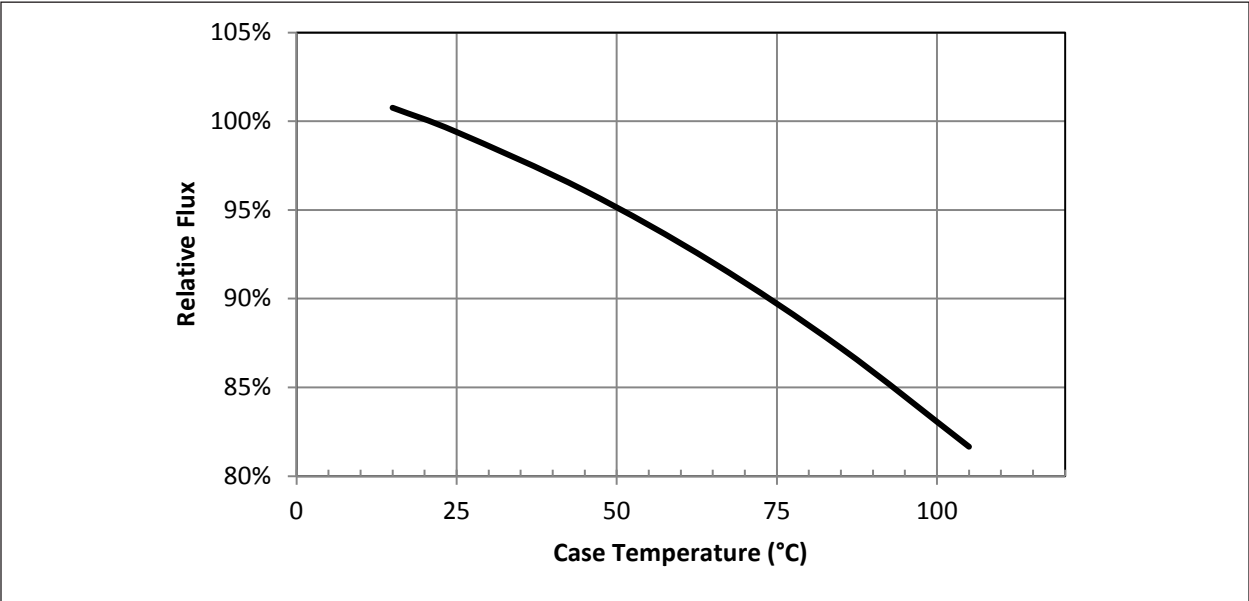

# Performance Curves

Figure 6: Typical DC ccy Shift vs. Case Temperature

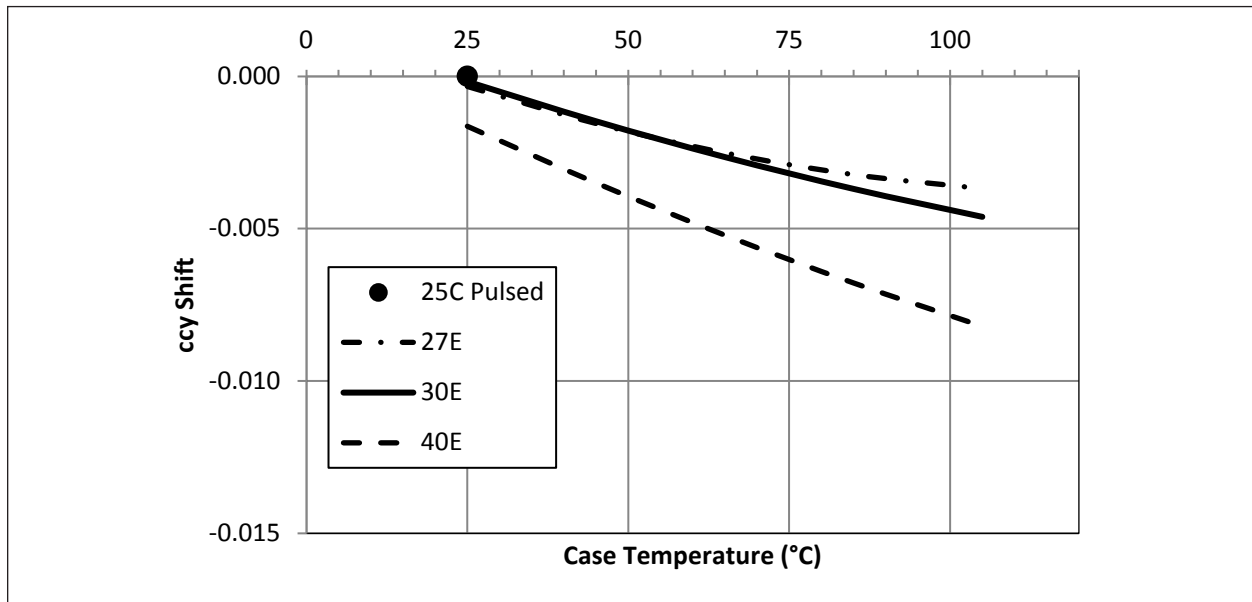
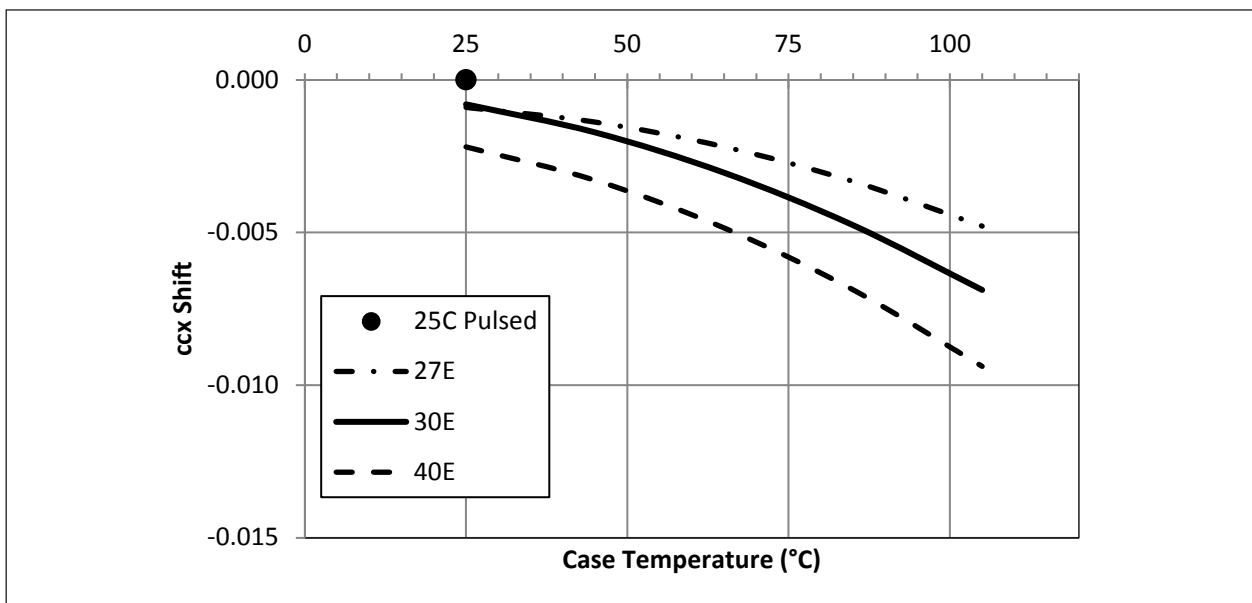

Figure 7: Typical DC ccx Shift vs. Case Temperature



Notes for Figures 6 and 7:

1. Characteristics shown for 27E based on 2700K and 80 CRI.
2. Characteristics shown for 30E based on 3000K and 80 CRI.
3. Characteristics shown for 40E based on 4000K and 80 CRI.
4. For other color SKUs, the shift in color will vary. Please contact your Bridgelux Sales Representative for more information.

# Typical Radiation Pattern

**Figure 8: Typical Spatial Radiation Pattern**

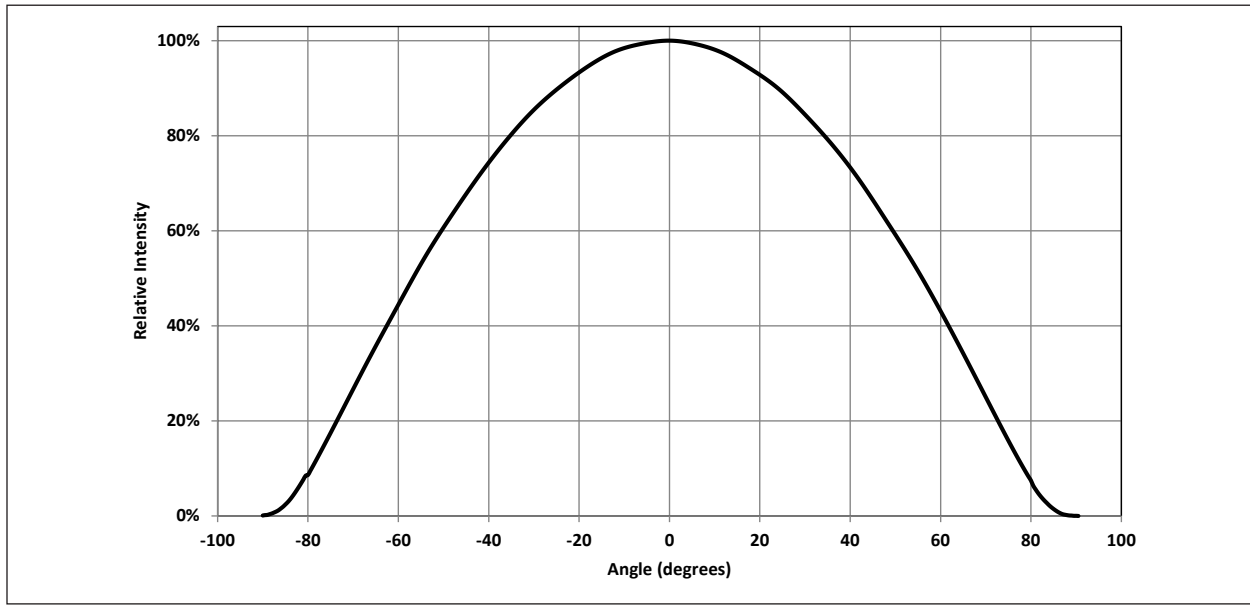

Note for Figure 8:

1. Typical viewing angle is  $112^\circ$ .
2. The viewing angle is defined as the off axis angle from the centerline where intensity is 50% of the peak value.

# Typical Color Spectrum

Figure 9: Typical Color Spectrum

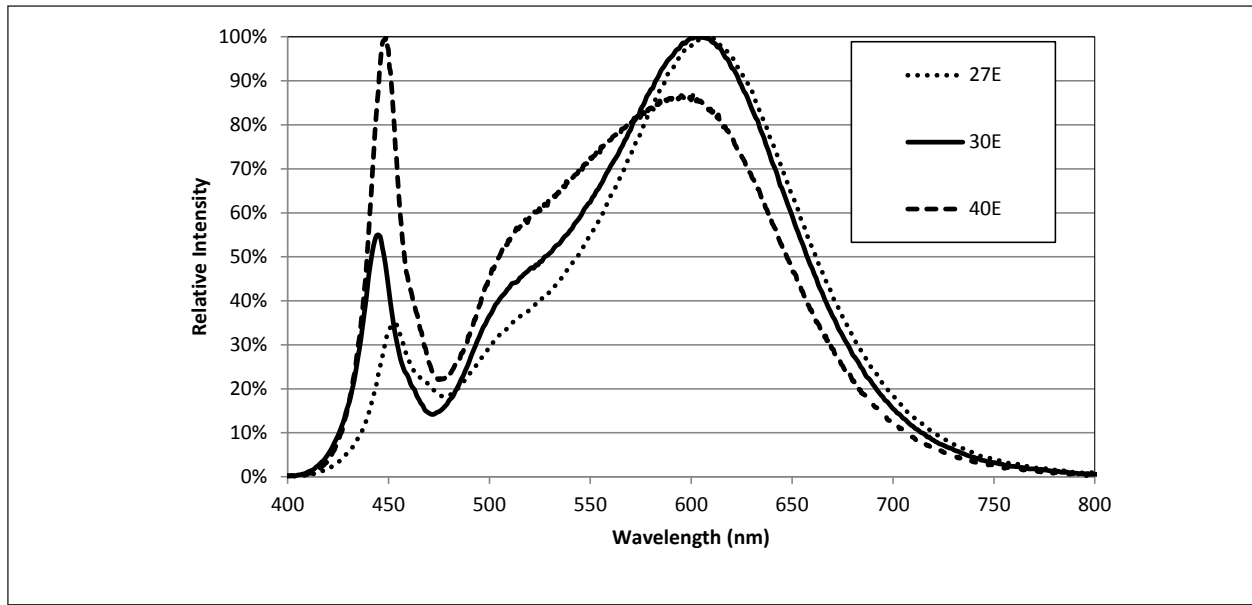

Notes for Figure 9:

1. Color spectra measured at nominal current for  $T_j = T_c = 25^\circ\text{C}$ .
2. Color spectra shown for 27E is 2700K and 80 CRI.
3. Color spectra shown for 30E is 3000K and 80 CRI.
4. Color spectra shown for 40E is 4000K and 80 CRI.

# Mechanical Dimensions

**Figure 10: Drawing for H15 LED Array**

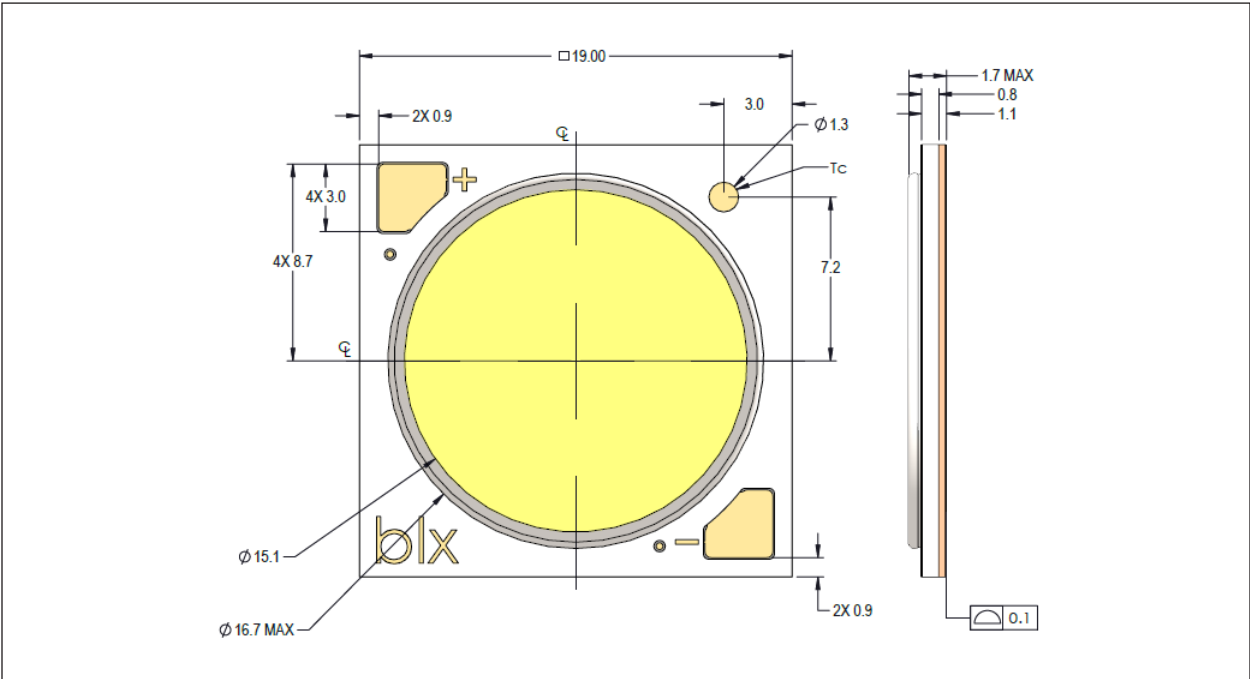

Notes for Figure 10:

1. Solder pads are labeled "+" and "-" to denote positive and negative polarity, respectively.
2. Drawings are not to scale.
3. Drawing dimensions are in millimeters.
4. Array length and width tolerances are  $\pm 0.2$  mm. Unless otherwise specified, all other tolerances are  $\pm 0.10$ mm.
5. The optical center of the LED Array is nominally defined by the mechanical center of the array.
6. Bridgelux maintains a flatness of 0.1 mm across the mounting surface of the array. Refer to Application Note AN81 for product handling, and mounting recommendations



# Color Binning Information

**Figure 11: Graph of Warm and Neutral White Test Bins in xy Color Space**

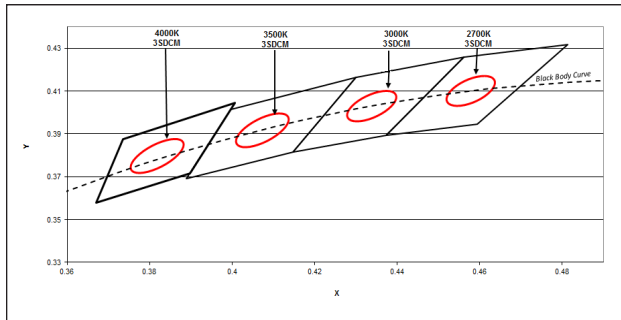

Note: Pulsed Test Conditions,  $T_c = 25^\circ\text{C}$

**Table 6: Warm and Neutral White xy Bin Coordinates and Associated Typical CCT<sup>1</sup>**

Bin Code	2700K	3000K	3500 K	4000K
ANSI Bin (for reference only)	(2580K - 2870K)	(2870K - 3220K)	(3220K - 3710K)	(3710K - 4260K)
23 (3SDCM)	(2651K - 2794K)	(2968K - 3136K)	(3369K - 3586K)	(3851K - 4130K)
Center Point (x,y)	(0.4578, 0.4101)	(0.4338, 0.403)	(0.4073, 0.3917)	(0.3818, 0.3797)

1. Does not apply to Class A color points.

# Packaging and Labeling

**Figure 12: H Series Packaging and Labeling**



Notes for Figure 12:

1. Each tube holds 25 H15 COB arrays.
2. One tube is sealed in an anti-static bag. Four such bags are placed in a box and shipped. Depending on quantities ordered, a bigger shipping box, containing four boxes will be used to ship products.
3. Each bag and box is to be labeled as shown above.
4. Dimensions for each tube are 21.3 (W) x 9.5(H) x 505 mm. Dimensions for the anti-static bag are 75 (W) x 615 (L) x 3.1 (T) mm and that of a shipping box are 58.7 x 13.3 x 7.9 cm.

**Figure 13: Product Labeling**

Bridgelux COB arrays have laser markings on the back side of the substrate to help with product identification. In addition to the product identification markings, Bridgelux COB arrays also contain markings for internal Bridgelux manufacturing use only. The image below shows which markings are for customer use and which ones are for Bridgelux internal use only. The Bridgelux internal manufacturing markings are subject to change without notice, however these will not impact the form, function or performance of the COB array.



# Design Resources

## Application Notes

Bridgelux has developed a comprehensive set of application notes and design resources to assist customers in successfully designing with the H Series product family of LED array products. For a list of resources under development, visit [www.bridgelux.com](http://www.bridgelux.com).

## Optical Source Models

Optical source models and ray set files are available for all Bridgelux products. For a list of available formats, visit [www.bridgelux.com](http://www.bridgelux.com).

# Precautions

## CAUTION: CHEMICAL EXPOSURE HAZARD

Exposure to some chemicals commonly used in luminaire manufacturing and assembly can cause damage to the LED array. Please consult Bridgelux Application Note AN81 for additional information.

## CAUTION: EYE SAFETY

Eye safety classification for the use of Bridgelux H Series LED arrays is in accordance with IEC specification TR 62778: Photobiological Safety of Lamps and Lamp Systems. H Series LED arrays are classified as Risk Group 2 (Moderate Risk) when operated at or below the maximum drive current. The Ethr value is 1187 lux per IEC/TR 62778. Please use appropriate precautions. It is important that employees working with LEDs are trained to use them safely.

## CAUTION: RISK OF BURN

Do not touch the H Series LED array during operation. Allow the array to cool for a sufficient period of time before handling. The H Series LED array may reach elevated temperatures such that could burn skin when touched.

# Disclaimers

## MINOR PRODUCT CHANGE POLICY

The rigorous qualification testing on products offered by Bridgelux provides performance assurance. Slight cosmetic changes that do not affect form, fit, or function may occur as Bridgelux continues product optimization.

## 3D CAD Models

Three dimensional CAD models depicting the product outline of all Bridgelux H Series LED arrays are available in both IGES and STEP formats. Visit [www.bridgelux.com](http://www.bridgelux.com) for details.

## CAUTION

### CONTACT WITH LIGHT EMITTING SURFACE (LES)

Avoid any contact with the LES. Do not touch the LES of the LED array or apply stress to the LES (yellow phosphor resin area). Contact may cause damage to the LED array.

Optics and reflectors must not be mounted in contact with the LES (yellow phosphor resin area). Use the LED array edges to locate and secure optical devices as needed but do not apply large bending forces on the edges of the array.

## STANDARD TEST CONDITIONS

Unless otherwise stated, array testing is performed at the nominal drive current.

# About Bridgelux: We Build Light That Transforms

At Bridgelux, we help companies, industries and people experience the power and possibility of light. Since 2002, we've designed LED solutions that are high performing, energy efficient, cost effective and easy to integrate. Our focus is on light's impact on human behavior, delivering products that create better environments, experiences and returns—both experiential and financial. And our patented technology drives new platforms for commercial and industrial luminaires.

**For more information about the company, please visit**  
**bridgelux.com**  
**twitter.com/Bridgelux**  
**facebook.com/Bridgelux**  
**https://www.linkedin.com/company/bridgelux-inc-\_2**  
**WeChat ID: BridgeluxInChina**



101 Portola Avenue  
Livermore, CA 94551  
Tel (925) 583-8400  
Fax (925) 583-8401  
**www.bridgelux.com**

© 2016 Bridgelux, Inc. All rights reserved. Product specifications are subject to change without notice. Bridgelux and the Bridgelux stylized logo design are registered trademarks, and Decor Series and H Series are trademarks, of Bridgelux, Inc. All other trademarks are the property of their respective owners.

Bridgelux H15 Array Product Data Sheet DS83 Rev. B (11/2016)