

General Description

The MIC5255 is an efficient, precise CMOS voltage regulator optimized for ultra-low-noise applications. It offers 1% initial accuracy, extremely-low dropout voltage (135mV at 150mA) and low ground current (typically 90 μ A). The MIC5255 provides a very-low-noise output, ideal for RF applications where a clean voltage source is required. A noise bypass pin is also available for further reduction of output noise.

Designed specifically for handheld and battery-powered devices, the MIC5255 provides a TTL-logic-compatible enable pin. When disabled, power consumption drops nearly to zero.

The MIC5255 also works with low-ESR ceramic capacitors, reducing the amount of board space necessary for power applications, critical in handheld wireless devices.

Key features include current limit, thermal shutdown, faster transient response, and an active clamp to speed up device turn-off. Available in the 6-pin 2mm \times 2mm MLF[®] package, the IttyBitty[®] SOT-23-5 package and the new Thin SOT-23-5, which offers the same footprint as the standard IttyBitty[®] SOT-23-5, but only 1mm tall. The MIC5255 offers a range of output voltages.

Data sheets and support documentation can be found on Micrel's web site at www.micrel.com.

Features

- Input voltage range: 2.7V to 6.0V
- Thin SOT package: 1mm height SOT-23-5
- Ultra-low output noise: 30 μ V(rms)
- Stability with ceramic output capacitors
- Ultra-low dropout: 135mV @ 150mA
- High output accuracy:
 - 1.0% initial accuracy
 - 2.0% over temperature
- Low quiescent current: 90 μ A
- Tight load and line regulation
- TTL-Logic-controlled enable input
- “Zero” off-mode current
- Thermal shutdown and current limit protection

Applications

- Cellular phones and pagers
- Cellular accessories
- Battery-powered equipment
- Laptop, notebook, and palmtop computers
- Consumer/personal electronics

Typical Application

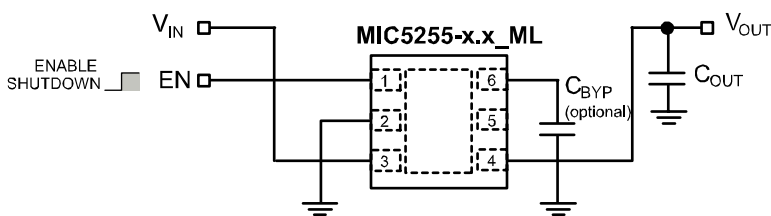
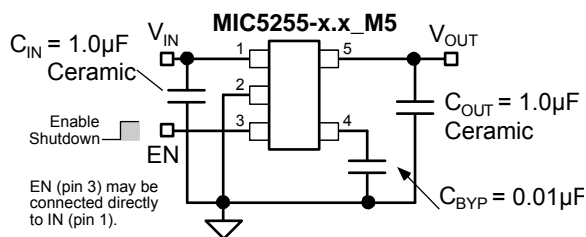

Ultra-Low-Noise Regulator Application

IttyBitty is a registered trademark of Micrel, Inc
MLF and MicroLeadFrame are registered trademarks of Amkor Technology, Inc.

Ordering Information

Part Number		Marking		Voltage*	Junction Temp. Range	Package
Standard	Pb-Free	Standard	Pb-Free**			
MIC5255-2.5BD5	MIC5255-2.5YD5	NW25	<u>NW</u> 25	2.5V	-40° to +125°C	5-Pin TSOT-23
MIC5255-2.5BM5	MIC5255-2.5YM5	LW25	<u>KW</u> 25	2.5V	-40° to +125°C	5-Pin SOT-23
MIC5255-2.6BD5	MIC5255-2.6YD5	NW26	<u>NW</u> 26	2.6V	-40° to +125°C	5-Pin TSOT-23
MIC5255-2.6BM5	MIC5255-2.6YM5	LW26	<u>KW</u> 26	2.6V	-40° to +125°C	5-Pin SOT-23
MIC5255-2.7BD5	MIC5255-2.7YD5	NW27	<u>NW</u> 27	2.7V	-40° to +125°C	5-Pin TSOT-23
MIC5255-2.7BM5	MIC5255-2.7YM5	LW27	<u>KW</u> 27	2.7V	-40° to +125°C	5-Pin SOT-23
MIC5255-2.75BM5	MIC5255-2.75YM5	LW2H	<u>KW</u> 2H	2.75V	-40° to +125°C	5-Pin SOT-23
MIC5255-2.8BD5	MIC5255-2.8YD5	NW28	<u>NW</u> 28	2.8V	-40° to +125°C	5-Pin TSOT-23
MIC5255-2.8BM5	MIC5255-2.8YM5	LW28	<u>KW</u> 28	2.8V	-40° to +125°C	5-Pin SOT-23
MIC5255-2.8BML	MIC5255-2.8YML	W28	<u>W</u> 28***	2.8V	-40° to +125°C	6-Pin 2x2 MLF®
MIC5255-2.85BD5	MIC5255-2.85YD5	NW2J	<u>NW</u> 2J	2.85V	-40° to +125°C	5-Pin TSOT-23
MIC5255-2.85BM5	MIC5255-2.85YM5	LW2J	<u>KW</u> 2J	2.85V	-40° to +125°C	5-Pin SOT-23
MIC5255-2.85BML	MIC5255-2.85YML	W2J	<u>W</u> 2J***	2.85V	-40° to +125°C	6-Pin 2x2 MLF®
MIC5255-2.9BD5	MIC5255-2.9YD5	NW29	<u>NW</u> 29	2.9V	-40° to +125°C	5-Pin TSOT-23
MIC5255-2.9BM5	MIC5255-2.9YM5	LW29	<u>KW</u> 29	2.9V	-40° to +125°C	5-Pin SOT-23
MIC5255-3.0BD5	MIC5255-3.0YD5	NW30	<u>NW</u> 30	3.0V	-40° to +125°C	5-Pin TSOT-23
MIC5255-3.0BM5	MIC5255-3.0YM5	LW30	<u>KW</u> 30	3.0V	-40° to +125°C	5-Pin SOT-23
MIC5255-3.0BML	MIC5255-3.0YML	W30	<u>W</u> 30***	3.0V	-40° to +125°C	6-Pin 2x2 MLF®
MIC5255-3.1BM5	MIC5255-3.1YM5	LW31	<u>KW</u> 31	3.1V	-40° to +125°C	5-Pin SOT-23
MIC5255-3.2BM5	MIC5255-3.2YM5	LW32	<u>KW</u> 32	3.2V	-40° to +125°C	5-Pin SOT-23
MIC5255-3.3BD5	MIC5255-3.3YD5	NW33	<u>NW</u> 33	3.3V	-40° to +125°C	5-Pin TSOT-23
MIC5255-3.3BM5	MIC5255-3.3YM5	LW33	<u>KW</u> 33	3.3V	-40° to +125°C	5-Pin SOT-23
MIC5255-3.3BML	MIC5255-3.3YML	W33	<u>W</u> 33***	3.3V	-40° to +125°C	6-Pin 2x2 MLF®
MIC5255-3.5BM5	MIC5255-3.5YM5	LW35	<u>KW</u> 35	3.5V	-40° to +125°C	5-Pin SOT-23

Notes:

- * Other Voltage available. Contact Micrel for details.
- ** Under bar / Over bar symbol may not be to scale.
- *** Over bar symbol located after Pin 1 identifier.

Pin Configuration

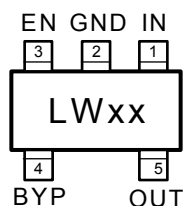

MIC5255-x.xBM5
5-Pin SOT23 (M5)

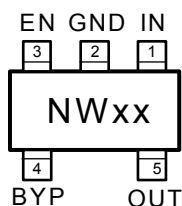

MIC5255-x.xBD5
5-Pin Thin SOT23 (D5)

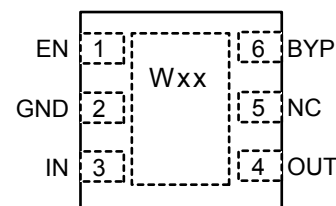

MIC5255-x.xBML
6-Pin 2x2 MLF[®] (ML)

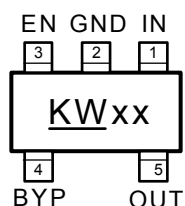

MIC5255-x.xYM5
5-Pin SOT23 (M5)

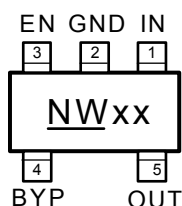

MIC5255-x.xYD5
5-Pin Thin SOT23 (D5)

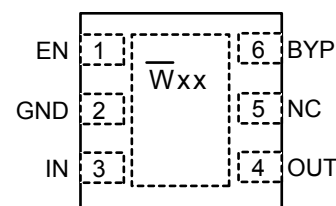

MIC5255-x.xYML
6-Pin 2x2 MLF[®] (ML)

Pin Description

Pin Number SOT23-5 TSOT23-5	Pin Number 6-MLF	Pin Name	Pin Name
1	3	IN	Supply Input.
2	2	GND	Ground.
3	1	EN	Enable/Shutdown (Input): CMOS compatible input. Logic high = enable; logic low = shutdown. Do not leave open.
4	6	BYP	Reference Bypass: Connect external $0.01\mu\text{F} \leq \text{CBYP} \leq 1.0\mu\text{F}$ capacitor to GND to reduce output noise. May be left open.
5	4	OUT	Regulator Output.
–	5	NC	No internal connection.
–	EP	GND	Ground: Internally connected to the exposed pad. Connect externally to GND pin.

Absolute Maximum Ratings⁽¹⁾

Supply Voltage (V_{IN})	0V to +7V
Enable Voltage (V_{EN})	0V to +7V
Power Dissipation (P_D)	Internally Limited ⁽³⁾
Junction Temperature (T_J)	-40°C to +125°C
Storage Temperature (T_S)	-60°C to +150°C
Lead Temperature (soldering, 5 sec.)	260°C
EDS Rating ⁽⁴⁾	2kV

Operating Ratings⁽²⁾

Supply Voltage (V_{IN})	+2.7V to +6V
Enable Voltage (V_{EN})	0V to V_{IN}
Junction Temperature (T_J)	-40°C to +125°C
Thermal Resistance	
SOT23-5 (θ_{JA})	235°C/W
2x2 MLF-6 (θ_{JA})	90°C/W

Electrical Characteristics⁽⁵⁾

$V_{IN} = V_{OUT} + 1V$, $V_{EN} = V_{IN}$; $I_{OUT} = 100\mu A$; $T_J = 25^\circ C$, **bold** values indicate $-40^\circ C \leq T_J \leq +125^\circ C$; unless noted.

Symbol	Parameter	Condition	Min	Typ	Max	Units
V_O	Output Voltage Accuracy	$I_{OUT} = 100\mu A$	-1		1	%
			-2		2	%
ΔV_{LNR}	Line Regulation	$V_{IN} = V_{OUT} + 1V$ to 6V		0.02	0.05	%/V
ΔV_{LDR}	Load Regulation	$I_{OUT} = 0.1mA$ to 150mA ⁽⁶⁾		1.5	2.5	%
$V_{IN} - V_{OUT}$	Dropout Voltage ⁽⁷⁾	$I_{OUT} = 100\mu A$		0.1	5	mV
		$I_{OUT} = 100mA$		90	150	mV
		$I_{OUT} = 150mA$		135	200 250	mV mV
I_Q	Quiescent Current	$V_{EN} \leq 0.4V$ (shutdown)		0.2	1	μA
I_{GND}	Ground Pin Current ⁽⁸⁾	$I_{OUT} = 0mA$		90	150	μA
		$I_{OUT} = 150mA$		117		μA
PSRR	Ripple Rejection	$f = 10Hz$, $C_{OUT} = 1.0\mu F$, $C_{BYP} = 0.01\mu F$		60		dB
		$f = 100Hz$, $V_{IN} = V_{OUT} + 1$		60		dB
		$f = 10kHz$, $V_{IN} = V_{OUT} + 1$		50		dB
I_{LIM}	Current Limit	$V_{OUT} = 0V$	160	425		mV
e_n	Output Voltage Noise	$C_{OUT} = 1.0\mu F$, $C_{BYP} = 0.01\mu F$, $f = 10Hz$ to 100kHz		30		$\mu V(rms)$
Enable Input						
V_{IL}	Enable Input Logic-Low Voltage	$V_{IN} = 2.7V$ to 5.5V, regulator shutdown			0.4	V
V_{IH}	Enable Input Logic-High Voltage	$V_{IN} = 2.7V$ to 5.5V, regulator enabled	1.6			V
I_{EN}	Enable Input Current	$V_{IL} \leq 0.4V$, regulator shutdown		0.01		μA
		$V_{IH} \geq 1.6V$, regulator enabled		0.01		μA
	Shutdown Resistance Discharge			500		Ω
Thermal Protection						
	Thermal Shutdown Temperature			150		$^\circ C$
	Thermal Shutdown Hysteresis			10		$^\circ C$

Notes:

1. Exceeding the absolute maximum rating may damage the device.
2. The device is not guaranteed to function outside its operating rating.
3. The maximum allowable power dissipation of any T_A (ambient temperature) is $P_{D(max)} = (T_{J(max)} - T_A) / \theta_{JA}$. Exceeding the maximum allowable power dissipation will result in excessive die temperature, and the regulator will go into thermal shutdown. The θ_{JA} of the MIC5255-x.xBM5 (all versions) is 235°C/W on a PC board. See "Thermal Considerations" section for further details.
4. Devices are ESD sensitive. Handling precautions recommended. Human body model, 1.5k in series with 100pF.
5. Specification for packaged product only.
6. Regulation is measured at constant junction temperature using low duty cycle pulse testing. Parts are tested for load regulation in the load range from 1.0mA to 150mA. Changes in output voltage due to heating effects are covered by the thermal regulation specification.
7. Dropout Voltage is defined as the input-to-output differential at which the output voltage drops 2% below its nominal value measured at 1V differential. For outputs below 2.7V, dropout voltage is the input-to-output voltage differential with the minimum input voltage 2.7V. Minimum input operating voltage is 2.7V.
8. Ground pin current is the regulator quiescent current. The total current drawn from the supply is the sum of the load current plus the ground pin current.

Typical Characteristics

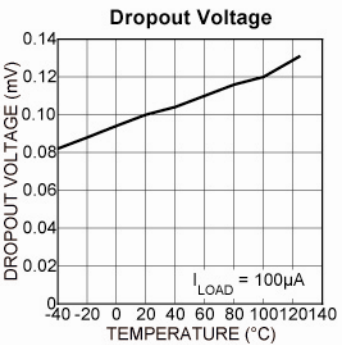
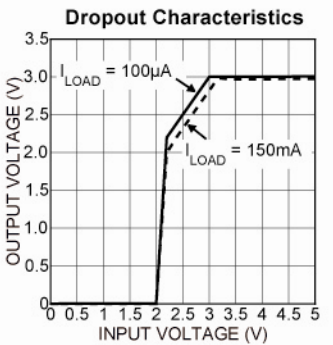
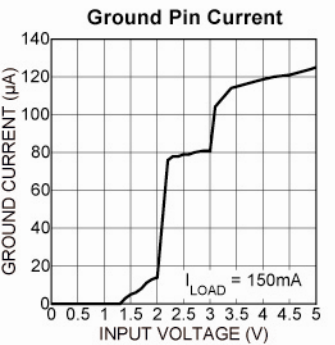
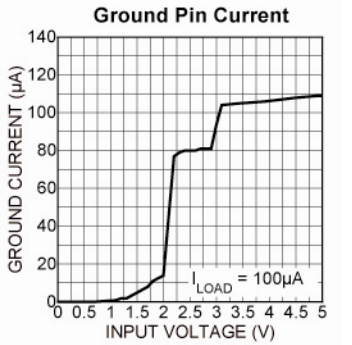
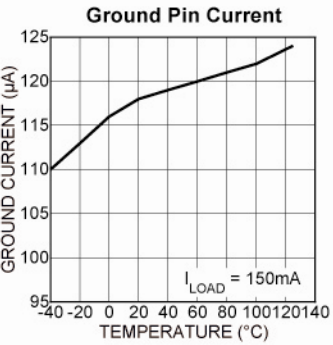
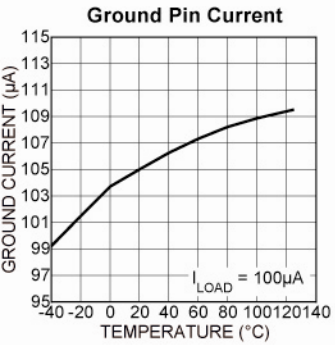
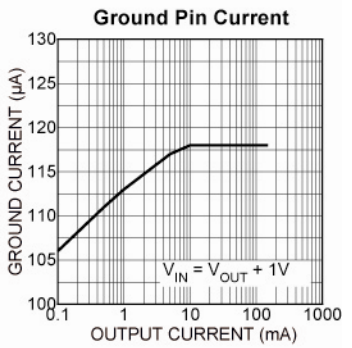
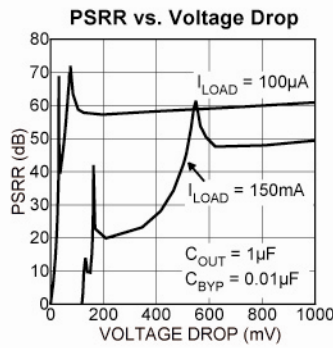
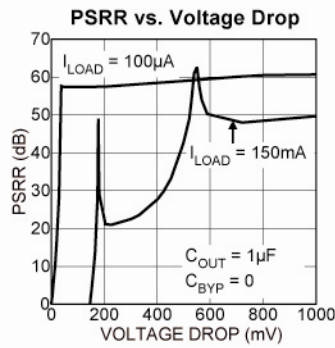
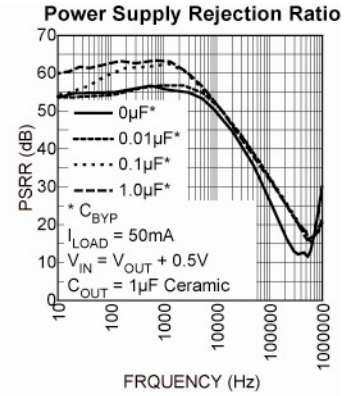
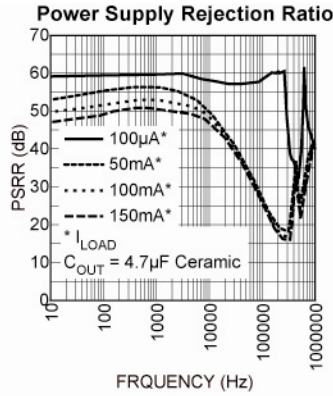
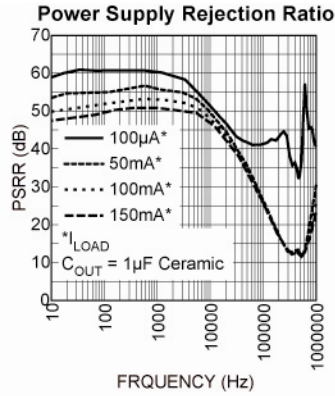

Functional Characteristics

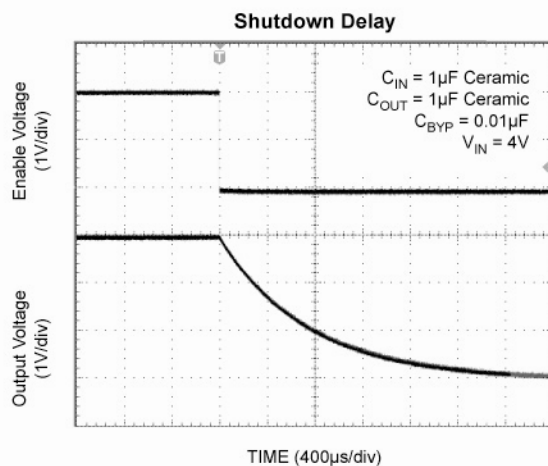
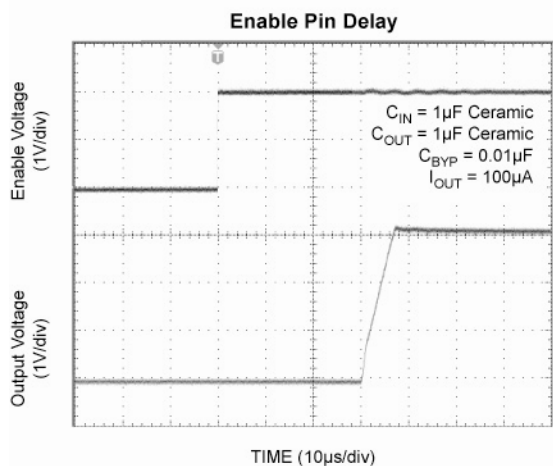
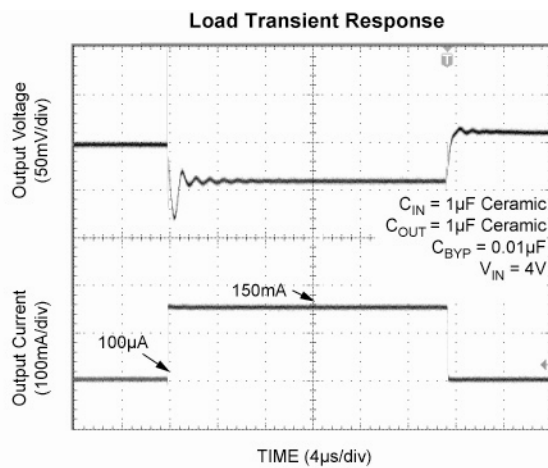
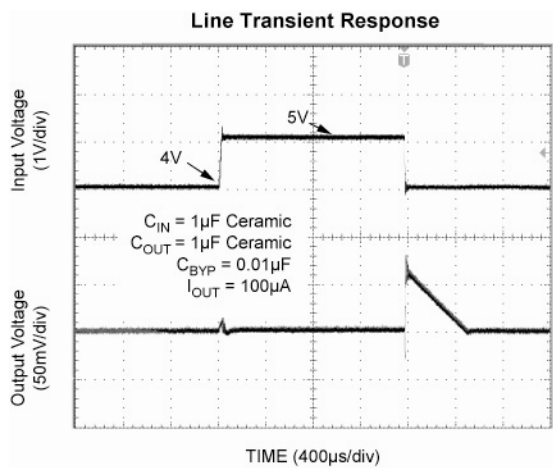

Functional Diagram

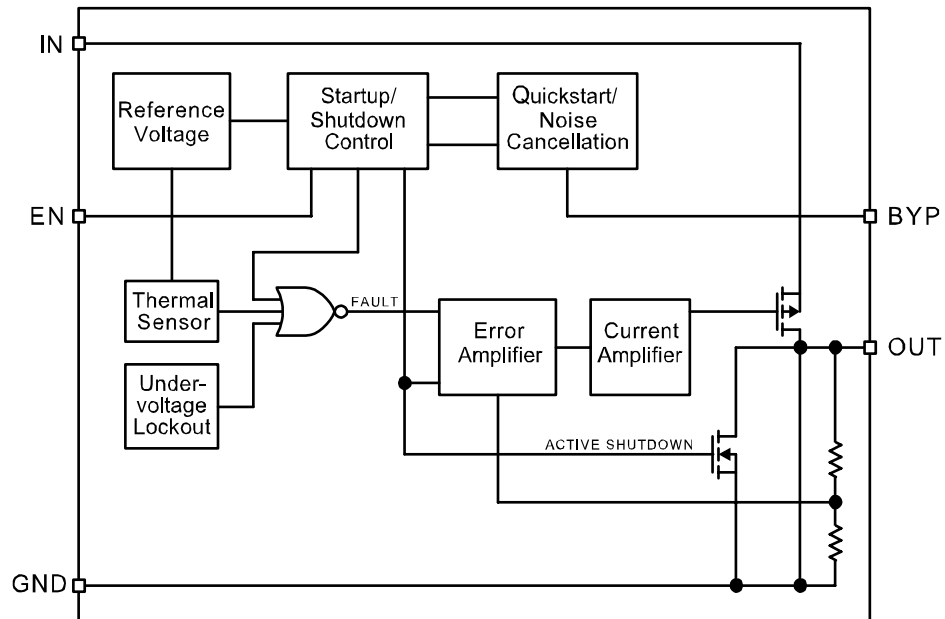

Application Information

Enable/Shutdown

The MIC5255 comes with an active-high enable pin that allows the regulator to be disabled. Forcing the enable pin low disables the regulator and sends it into a “zero” off-mode-current state. In this state, current consumed by the regulator goes nearly to zero. Forcing the enable pin high enables the output voltage. This part is CMOS and the enable pin cannot be left floating; a floating enable pin may cause an indeterminate state on the output.

Input Capacitor

The MIC5255 is a high performance, high bandwidth device. Therefore, it requires a well-bypassed input supply for optimal performance. A 1 μ F capacitor is required from the input to ground to provide stability. Low-ESR ceramic capacitors provide optimal performance at a minimum of space. Additional high frequency capacitors, such as small valued NPO dielectric type capacitors, help filter out high frequency noise and are good practice in any RF-based circuit.

Output Capacitor

The MIC5255 requires an output capacitor for stability. The design requires 1 μ F or greater on the output to maintain stability. The design is optimized for use with low-ESR ceramic chip capacitors. High ESR capacitors may cause high frequency oscillation. The maximum recommended ESR is 300m Ω . The output capacitor can be increased, but performance has been optimized for a 1 μ F ceramic output capacitor and does not improve significantly with larger capacitance.

X7R/X5R dielectric-type ceramic capacitors are recommended because of their temperature performance. X7R-type capacitors change capacitance by 15% over their operating temperature range and are the most stable type of ceramic capacitors. Z5U and Y5V dielectric capacitors change value by as much as 50% and 60%, respectively, over their operating temperature ranges. To use a ceramic chip capacitor with Y5V dielectric, the value must be much higher than an X7R ceramic capacitor to ensure the same minimum capacitance over the equivalent operating temperature range.

Bypass Capacitor

A capacitor can be placed from the noise bypass pin to ground to reduce output voltage noise. The capacitor bypasses the internal reference. A 0.01 μ F capacitor is recommended for applications that require low-noise outputs. The bypass capacitor can be increased, further reducing noise and improving PSRR. Turn-on time increases slightly with respect to bypass capacitance. A unique quick-start circuit allows the MIC5255 to drive a

large capacitor on the bypass pin without significantly slowing turn-on time. Refer to the “*Typical Characteristics*” section for performance with different bypass capacitors.

Active Shutdown

The MIC5255 also features an active shutdown clamp, which is an N-Channel MOSFET that turns on when the device is disabled. This allows the output capacitor and load to discharge, de-energizing the load.

No-Load Stability

The MIC5255 will remain stable and in regulation with no load unlike many other voltage regulators. This is especially important in CMOS RAM keep-alive applications.

Thermal Considerations

The MIC5255 is designed to provide 150mA of continuous current in a very small package. Maximum power dissipation can be calculated based on the output current and the voltage drop across the part. To determine the maximum power dissipation of the package, use the junction-to-ambient thermal resistance of the device and the following basic equation:

$$P_{D(\max)} = \left(\frac{T_{J(\max)} - T_A}{\theta_{JA}} \right)$$

$T_{J(\max)}$ is the maximum junction temperature of the die, 125°C, and T_A is the ambient operating temperature. θ_{JA} is layout dependent; Table 1 shows examples of junction-to-ambient thermal resistance for the MIC5255.

Package	θ_{JA} Recommended Minimum Footprint	θ_{JA} 1" Square Copper Clad	θ_{JC}
SOT23-5 (M5 or D5)	235°C/W	185°C/W	145°C/W

Table 1. SOT-23-5 Thermal Resistance

The actual power dissipation of the regulator circuit can be determined using the equation:

$$P_D = (V_{IN} - V_{OUT}) I_{OUT} + V_{IN} I_{GND}$$

Substituting $P_{D(\max)}$ for P_D and solving for the operating conditions that are critical to the application will give the maximum operating conditions for the regulator circuit. For example, when operating the MIC5255-3.0BM5 at 50°C with a minimum footprint layout, the maximum input voltage for a set output current can be determined as follows:

$$P_{D(\max)} = \left(\frac{125^\circ\text{C} - 50^\circ\text{C}}{235^\circ\text{C/W}} \right)$$

$$P_{D(\max)} = 315\text{mW}$$

The junction-to-ambient thermal resistance for the minimum footprint is 235°C/W, from Table 1. The maximum power dissipation must not be exceeded for proper operation. Using the output voltage of 3.0V and an output current of 150mA, the maximum input voltage can be determined. Because this device is CMOS and the ground current is typically 100µA over the load range, the power dissipation contributed by the ground current is < 1% and can be ignored for this calculation:

$$315\text{mW} = (V_{\text{IN}} - 3.0\text{V}) 150\text{mA}$$

$$315\text{mW} = V_{\text{IN}} \times 150\text{mA} - 450\text{mW}$$

$$810\text{mW} = V_{\text{IN}} \times 150\text{mA}$$

$$V_{\text{IN(max)}} = 5.4\text{V}$$

Therefore, a 3.0V application at 150mA of output current can accept a maximum input voltage of 5.4V in a SOT-23-5 package. For a full discussion of heat sinking and thermal effects on voltage regulators, refer to the “*Regulator Thermals*” section of Micrel’s [Designing with Low-Dropout Voltage Regulators](#) handbook.

Package Information

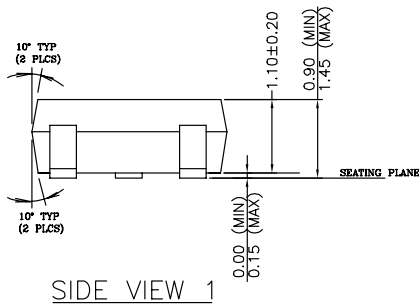
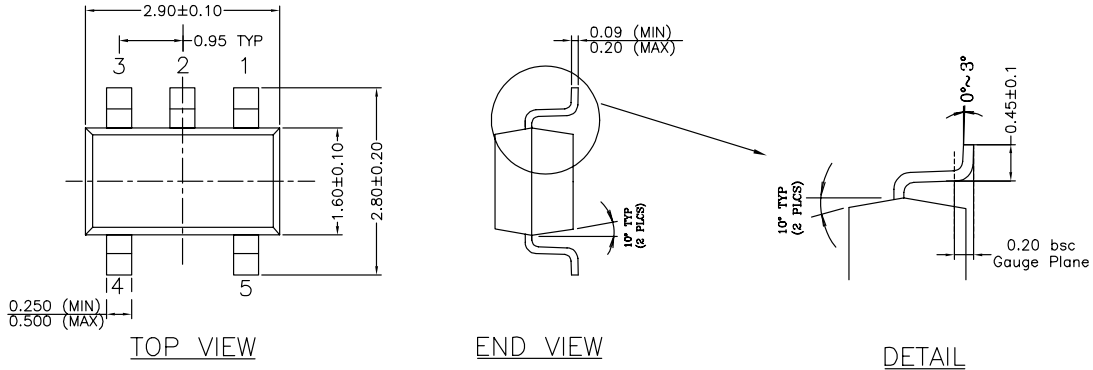

NOTE:
 1. PACKAGE OUTLINE EXCLUSIVE OF MOLD FLASH & BURR.
 2. PACKAGE OUTLINE INCLUSIVE OF SOLER PLATING.
 3. DIMENSION AND TOLERANCE PER ANSI Y14.5M, 1982.
 4. FOOT LENGTH MEASUREMENT BASED ON GAUGE PLANE METHOD.
 5. DIE FACES UP FOR MOLD, AND FACES DOWN FOR TRIM/FORM.
 6. ALL DIMENSIONS ARE IN MILLIMETERS.

5-Pin SOT (M5)

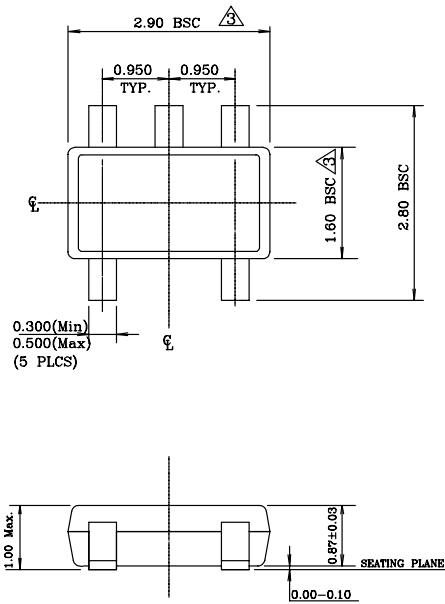

NOTE:
 1. Dimensions and tolerances are as per ANSI Y14.5M, 1994.
 2. Die is facing up for mold. Die is facing down for trim/form, ie. reverse trim/form.
 3. Dimensions are exclusive of mold flash and gate burr.
 4. The footlength measuring is based on the gauge plane method.
 5. All specification comply to Jedec Spec M0193 Issue C.
 6. All dimensions are in millimeters.

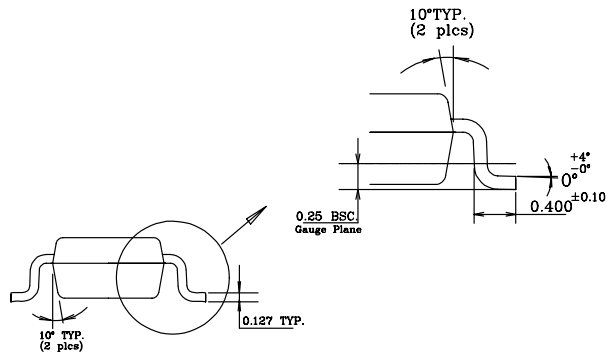

5-Pin Thin SOT (D5)

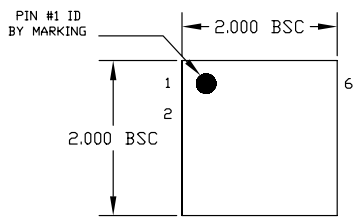

TOP VIEW

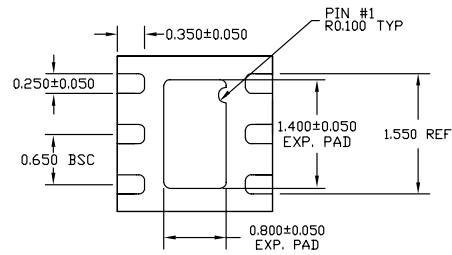

BOTTOM VIEW

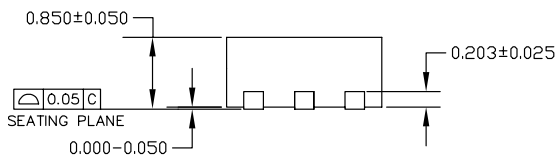

SIDE VIEW

- NOTE:
1. ALL DIMENSIONS ARE IN MILLIMETERS.
 2. MAX. PACKAGE WARPAGE IS 0.05 mm.
 3. MAXIMUM ALLOWABLE BURRS IS 0.076 mm IN ALL DIRECTIONS.
 4. PIN #1 ID ON TOP WILL BE LASER MARKED.

6-Pin MLF[®] (ML)

MICREL, INC. 2180 FORTUNE DRIVE SAN JOSE, CA 95131 USA
 TEL +1 (408) 944-0800 FAX +1 (408) 474-1000 WEB <http://www.micrel.com>

The information furnished by Micrel in this data sheet is believed to be accurate and reliable. However, no responsibility is assumed by Micrel for its use. Micrel reserves the right to change circuitry and specifications at any time without notification to the customer.

Micrel Products are not designed or authorized for use as components in life support appliances, devices or systems where malfunction of a product can reasonably be expected to result in personal injury. Life support devices or systems are devices or systems that (a) are intended for surgical implant into the body or (b) support or sustain life, and whose failure to perform can be reasonably expected to result in a significant injury to the user. A Purchaser's use or sale of Micrel Products for use in life support appliances, devices or systems is a Purchaser's own risk and Purchaser agrees to fully indemnify Micrel for any damages resulting from such use or sale.

© 2004 Micrel, Incorporated.