

National Semiconductor is now part of
Texas Instruments.

Search <http://www.ti.com/> for the latest technical
information and details on our current products and services.



NATL SEMICON (LINEAR)

T58-11-13

LM341 Series

LM341, LM78MXX Series 3-Terminal Positive Voltage Regulators

General Description

The LM341 and LM78MXX series of three-terminal positive voltage regulators employ built-in current limiting, thermal shutdown, and safe-operating area protection which makes them virtually immune to damage from output overloads.

With adequate heatsinking, they can deliver in excess of 0.5A output current. Typical applications would include local (on-card) regulators which can eliminate the noise and degraded performance associated with single-point regulation.

Features

- Output current in excess of 0.5A
- No external components
- Internal thermal overload protection
- Internal short circuit current-limiting
- Output transistor safe-area compensation
- Available in TO-220, TO-39 and TO-202 packages
- Output voltages of 5V, 6V, 8V, 12V, 15V, and 24V

Connection Diagrams

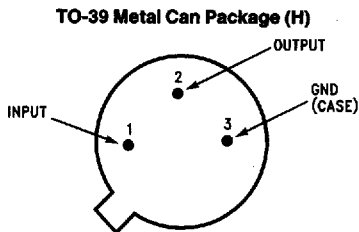

Bottom View

TL/H/10484-5

Order Number LM78M05CH, LM78M06CH, LM78M08CH,
LM78M12CH, LM78M15CH or LM78M24CH
See NS Package Number H03B

**TO-202 (P)
Plastic Package**

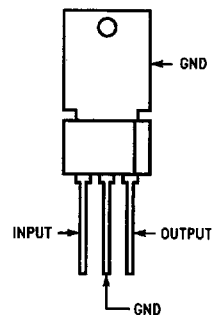

TL/H/10484-2

Order Number LM341P-5.0, LM341P-12 or LM341P-15
See NS Package Number P03A

TO-220 Power Package (T)

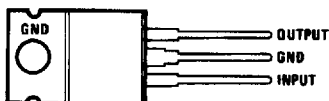

Top View

TL/H/10484-6

Order Number LM78M05CT, LM78M06CT, LM78M08CT,
LM78M12CT, LM78M15CT, LM78M24CT,
LM341T-5.0, LM341T-12 or LM341T-15
See NS Package Number T03B

DUAL MARKING: The LM341T-5.0 and the LM78M05CT parts are "dual marked" (these parts are marked with both part numbers) because they have the same specifications. The same is true for the LM341T-12/LM78M12CT and the LM341T-15/LM78M15CT part number sets.

NATL SEMICONDC (LINEAR)

Absolute Maximum Ratings (Note 1)

If Military/Aerospace specified devices are required, please contact the National Semiconductor Sales Office/Distributors for availability and specifications.

Lead Temperature (Soldering, 10 seconds)	
TO-39 Package (H)	300°C
TO-220 Package (T)	260°C
TO-202 Package (P)	230°C

Storage Temperature Range	-65°C to +150°C
Operating Junction Temperature Range	-40°C to +125°C
Power Dissipation (Note 2)	Internally Limited
Input Voltage	
5V ≤ V _O ≤ 15V	35V
V _O = 24V	40V
ESD Susceptibility	TBD

Electrical Characteristics

Limits in standard typeface are for T_J = 25°C, and limits in **boldface type** apply over the -40°C to +125°C operating temperature range. Limits are guaranteed by production testing or correlation techniques using standard Statistical Quality Control (SQC) methods.

LM341-5.0, LM78M05C Unless otherwise specified: V_{IN} = 10V, C_{IN} = 0.33 μF, C_O = 0.1 μF

Symbol	Parameter	Conditions	Min	Typ	Max	Units
V _O	Output Voltage	I _L = 500 mA	4.8	5.0	5.2	V
		5 mA ≤ I _L ≤ 500 mA P _D ≤ 7.5W, 7.5V ≤ V _{IN} ≤ 20V	4.75	5.0	5.25	
V _{R LINE}	Line Regulation	7.2V ≤ V _{IN} ≤ 25V	I _L = 100 mA		50	mV
			I _L = 500 mA		100	
V _{R LOAD}	Load Regulation	5 mA ≤ I _L ≤ 500 mA			100	
I _Q	Quiescent Current	I _L = 500 mA		4	10.0	mA
ΔI _Q	Quiescent Current Change	5 mA ≤ I _L ≤ 500 mA			0.5	
		7.5V ≤ V _{IN} ≤ 25V, I _L = 500 mA			1.0	
V _n	Output Noise Voltage	f = 10 Hz to 100 kHz		40		μV
$\frac{\Delta V_{IN}}{\Delta V_O}$	Ripple Rejection	f = 120 Hz, I _L = 500 mA		78		dB
V _{IN}	Input Voltage Required to Maintain Line Regulation	I _L = 500 mA	7.2			V
ΔV _O	Long Term Stability	I _L = 500 mA			20	mV/khrs

NATL SEMICON (LINEAR)

LM341 Series

Electrical Characteristics

Limits in standard typeface are for $T_J = 25^\circ\text{C}$, and limits in **boldface type** apply over the -40°C to $+125^\circ\text{C}$ operating temperature range. Limits are guaranteed by production testing or correlation techniques using standard Statistical Quality Control (SQC) methods. (Continued)

LM78M06C Unless otherwise specified: $V_{IN} = 11\text{V}$, $C_{IN} = 0.33\ \mu\text{F}$, $C_O = 0.1\ \mu\text{F}$

Symbol	Parameter	Conditions	Min	Typ	Max	Units
V_O	Output Voltage	$I_L = 350\ \text{mA}$	5.75	6.0	6.25	V
		$5\ \text{mA} \leq I_L \leq 350\ \text{mA}$ $8\ \text{V} \leq V_{IN} \leq 21\ \text{V}$	5.7	6.0	6.3	
$V_{R\ \text{LINE}}$	Line Regulation	$9\ \text{V} \leq V_{IN} \leq 20\ \text{V}$, $I_L = 200\ \text{mA}$		1.5	50	mV
		$8\ \text{V} \leq V_{IN} \leq 25\ \text{V}$, $I_L = 200\ \text{mA}$		5	100	
$V_{R\ \text{LOAD}}$	Load Regulation	$5\ \text{mA} \leq I_L \leq 200\ \text{mA}$		10	60	
		$5\ \text{mA} \leq I_L \leq 500\ \text{mA}$		20	120	
I_Q	Quiescent Current	$I_L = 350\ \text{mA}$		4.5	8.0	mA
ΔI_Q	Quiescent Current Change	$5\ \text{mA} \leq I_L \leq 350\ \text{mA}$			0.5	
		$9\ \text{V} \leq V_{IN} \leq 25\ \text{V}$, $I_L = 200\ \text{mA}$			0.8	
V_n	Output Noise Voltage	$f = 10\ \text{Hz to } 100\ \text{kHz}$		45		μV
$\frac{\Delta V_{IN}}{\Delta V_O}$	Ripple Rejection	$f = 2400\ \text{Hz}$, $I_L = 125\ \text{mA}$	59	80		dB
V_{IN}	Input Voltage Required to Maintain Line Regulation	$I_L = 350\ \text{mA}$		$V_O + 2$		V
I_{OS}	Output Short Circuit Current	$V_{IN} = 35\ \text{V}$		270		mA
I_{PK}	Output Peak Current			700		
$\frac{\Delta V_O}{\Delta T}$	Average Temperature Coefficient of Output Voltage	$I_L = 5\ \text{mA}$		0.5		mV/ $^\circ\text{C}$

NATL SEMICOND (LINEAR)

Electrical Characteristics

Limits in standard typeface are for $T_J = 25^\circ\text{C}$, and limits in **boldface type** apply over the -40°C to $+125^\circ\text{C}$ operating temperature range. Limits are guaranteed by production testing or correlation techniques using standard Statistical Quality Control (SQC) methods. (Continued)

LM78M08C Unless otherwise specified: $V_{IN} = 14\text{V}$, $C_{IN} = 0.33\ \mu\text{F}$, $C_O = 0.1\ \mu\text{F}$

Symbol	Parameter	Conditions	Min	Typ	Max	Units
V_O	Output Voltage	$I_L = 350\ \text{mA}$	7.7	8.0	8.3	V
		$5\ \text{mA} \leq I_L \leq 350\ \text{mA}$ $10.5\ \text{V} \leq V_{IN} \leq 23\ \text{V}$	7.6	8.0	8.4	
$V_{R\ \text{LINE}}$	Line Regulation	$11\ \text{V} \leq V_{IN} \leq 20\ \text{V}$, $I_L = 200\ \text{mA}$		2	50	mV
		$10.5\ \text{V} \leq V_{IN} \leq 25\ \text{V}$, $I_L = 200\ \text{mA}$		6	100	
$V_{R\ \text{LOAD}}$	Load Regulation	$5\ \text{mA} \leq I_L \leq 200\ \text{mA}$		10	80	
		$5\ \text{mA} \leq I_L \leq 500\ \text{mA}$		25	160	
I_Q	Quiescent Current	$I_L = 350\ \text{mA}$		4.6	8.0	mA
ΔI_Q	Quiescent Current Change	$5\ \text{mA} \leq I_L \leq 350\ \text{mA}$			0.5	
		$10.5\ \text{V} \leq V_{IN} \leq 25\ \text{V}$, $I_L = 200\ \text{mA}$			0.8	
V_n	Output Noise Voltage	$f = 10\ \text{Hz to } 100\ \text{kHz}$		52		μV
$\frac{\Delta V_{IN}}{\Delta V_O}$	Ripple Rejection	$f = 2400\ \text{Hz}$, $I_L = 125\ \text{mA}$	56	80		dB
V_{IN}	Input Voltage Required to Maintain Line Regulation	$I_L = 350\ \text{mA}$		$V_O + 2$		V
I_{OS}	Output Short Circuit Current	$V_{IN} = 35\ \text{V}$		250		mA
I_{PK}	Output Peak Current			700		
$\frac{\Delta V_O}{\Delta T}$	Average Temperature Coefficient of Output Voltage	$I_L = 5\ \text{mA}$		0.5		mV/ $^\circ\text{C}$

NATL SEMICON (LINEAR)

LM341 Series

Electrical Characteristics

Limits in standard typeface are for $T_J = 25^\circ\text{C}$, and limits in **boldface type** apply over the -40°C to $+125^\circ\text{C}$ operating temperature range. Limits are guaranteed by production testing or correlation techniques using standard Statistical Quality Control (SQC) methods. (Continued)

LM341-12, LM78M12C Unless otherwise specified: $V_{IN} = 19\text{V}$, $C_{IN} = 0.33\ \mu\text{F}$, $C_O = 0.1\ \mu\text{F}$

Symbol	Parameter	Conditions	Min	Typ	Max	Units
V_O	Output Voltage	$I_L = 500\ \text{mA}$	11.5	12	12.5	V
		$5\ \text{mA} \leq I_L \leq 500\ \text{mA}$ $P_D \leq 7.5\text{W}$, $14.8\text{V} \leq V_{IN} \leq 27\text{V}$	11.4	12	12.6	
$V_{R\ \text{LINE}}$	Line Regulation	$14.5\text{V} \leq V_{IN} \leq 30\text{V}$	$I_L = 100\ \text{mA}$		120	mV
			$I_L = 500\ \text{mA}$		240	
$V_{R\ \text{LOAD}}$	Load Regulation	$5\ \text{mA} \leq I_L \leq 500\ \text{mA}$			240	
I_Q	Quiescent Current	$I_L = 500\ \text{mA}$		4	10.0	mA
ΔI_Q	Quiescent Current Change	$5\ \text{mA} \leq I_L \leq 500\ \text{mA}$ $14.8\text{V} \leq V_{IN} \leq 30\text{V}$, $I_L = 500\ \text{mA}$			0.5 1.0	
V_n	Output Noise Voltage	$f = 10\ \text{Hz}$ to $100\ \text{kHz}$		75		μV
$\frac{\Delta V_{IN}}{\Delta V_O}$	Ripple Rejection	$f = 120\ \text{Hz}$, $I_L = 500\ \text{mA}$		71		dB
V_{IN}	Input Voltage Required to Maintain Line Regulation	$I_L = 500\ \text{mA}$	14.5			V
ΔV_O	Long Term Stability	$I_L = 500\ \text{mA}$			48	mV/khrs

LM341-15, LM78M15C Unless otherwise specified: $V_{IN} = 23\text{V}$, $C_{IN} = 0.33\ \mu\text{F}$, $C_O = 0.1\ \mu\text{F}$

Symbol	Parameter	Conditions	Min	Typ	Max	Units
V_O	Output Voltage	$I_L = 500\ \text{mA}$	14.4	15	15.6	V
		$5\ \text{mA} \leq I_L \leq 500\ \text{mA}$ $P_D \leq 7.5\text{W}$, $18\text{V} \leq V_{IN} \leq 30\text{V}$	14.25	15	15.75	
$V_{R\ \text{LINE}}$	Line Regulation	$17.6\text{V} \leq V_{IN} \leq 30\text{V}$	$I_L = 100\ \text{mA}$		150	mV
			$I_L = 500\ \text{mA}$		300	
$V_{R\ \text{LOAD}}$	Load Regulation	$5\ \text{mA} \leq I_L \leq 500\ \text{mA}$			300	
I_Q	Quiescent Current	$I_L = 500\ \text{mA}$		4	10.0	mA
ΔI_Q	Quiescent Current Change	$5\ \text{mA} \leq I_L \leq 500\ \text{mA}$ $18\text{V} \leq V_{IN} \leq 30\text{V}$, $I_L = 500\ \text{mA}$			0.5 1.0	
V_n	Output Noise Voltage	$f = 10\ \text{Hz}$ to $100\ \text{kHz}$		90		μV
$\frac{\Delta V_{IN}}{\Delta V_O}$	Ripple Rejection	$f = 120\ \text{Hz}$, $I_L = 500\ \text{mA}$		69		dB
V_{IN}	Input Voltage Required to Maintain Line Regulation	$I_L = 500\ \text{mA}$	17.6			V
ΔV_O	Long Term Stability	$I_L = 500\ \text{mA}$			60	mV/khrs

NATL SEMICON (LINEAR)

LM341 Series

Electrical Characteristics

Limits in standard typeface are for $T_J = 25^\circ\text{C}$, and limits in **boldface type** apply over the -40°C to $+125^\circ\text{C}$ operating temperature range. Limits are guaranteed by production testing or correlation techniques using standard Statistical Quality Control (SQC) methods. (Continued)

LM78M24C Unless otherwise specified: $V_{IN} = 33\text{V}$, $C_{IN} = 0.33\ \mu\text{F}$, $C_O = 0.1\ \mu\text{F}$

Symbol	Parameter	Conditions	Min	Typ	Max	Units
V_O	Output Voltage	$I_L = 350\ \text{mA}$	23.0	24.0	25.0	V
		$5\ \text{mA} \leq I_L \leq 350\ \text{mA}$ $27\text{V} \leq V_{IN} \leq 38\text{V}$	22.8	24.0	25.2	
$V_{R\ \text{LINE}}$	Line Regulation	$28\text{V} \leq V_{IN} \leq 36\text{V}$, $I_L = 200\ \text{mA}$		5	50	mV
		$27\text{V} \leq V_{IN} \leq 38\text{V}$, $I_L = 200\ \text{mA}$		10	100	
$V_{R\ \text{LOAD}}$	Load Regulation	$5\ \text{mA} \leq I_L \leq 200\ \text{mA}$		10	240	mV
		$5\ \text{mA} \leq I_L \leq 500\ \text{mA}$		30	480	
I_Q	Quiescent Current	$I_L = 350\ \text{mA}$		5.0	8.0	mA
ΔI_Q	Quiescent Current Change	$5\ \text{mA} \leq I_L \leq 350\ \text{mA}$			0.5	
		$27\text{V} \leq V_{IN} \leq 38\text{V}$, $I_L = 200\ \text{mA}$			0.8	
V_n	Output Noise Voltage	$f = 10\ \text{Hz to } 100\ \text{kHz}$		170		μV
$\frac{\Delta V_{IN}}{\Delta V_O}$	Ripple Rejection	$f = 2400\ \text{Hz}$, $I_L = 125\ \text{mA}$, $V_{IN} = 30\text{V}$	50	70		dB
V_{IN}	Input Voltage Required to Maintain Line Regulation	$I_L = 350\ \text{mA}$		$V_O + 2$		V
I_{OS}	Output Short Circuit Current	$V_{IN} = 35\text{V}$		240		mA
I_{PK}	Output Peak Current			700		
$\frac{\Delta V_O}{\Delta T}$	Average Temperature Coefficient of Output Voltage	$I_L = 5\ \text{mA}$		1.2		mV/ $^\circ\text{C}$

Note 1: Absolute maximum ratings indicate limits beyond which damage to the component may occur. Electrical specifications do not apply when operating the device outside of its rated operating conditions.

Note 2: The typical thermal resistance of the three package types is:

T (TO-220) package: $\theta_{(J-A)} = 60\ ^\circ\text{C/W}$, $\theta_{(J-C)} = 5\ ^\circ\text{C/W}$

P (TO-202) package: $\theta_{(J-A)} = 70\ ^\circ\text{C/W}$, $\theta_{(J-C)} = 12\ ^\circ\text{C/W}$

H (TO-39) package: $\theta_{(J-A)} = 120\ ^\circ\text{C/W}$, $\theta_{(J-C)} = 18\ ^\circ\text{C/W}$

Schematic Diagram

NATL SEMICOND (LINEAR)

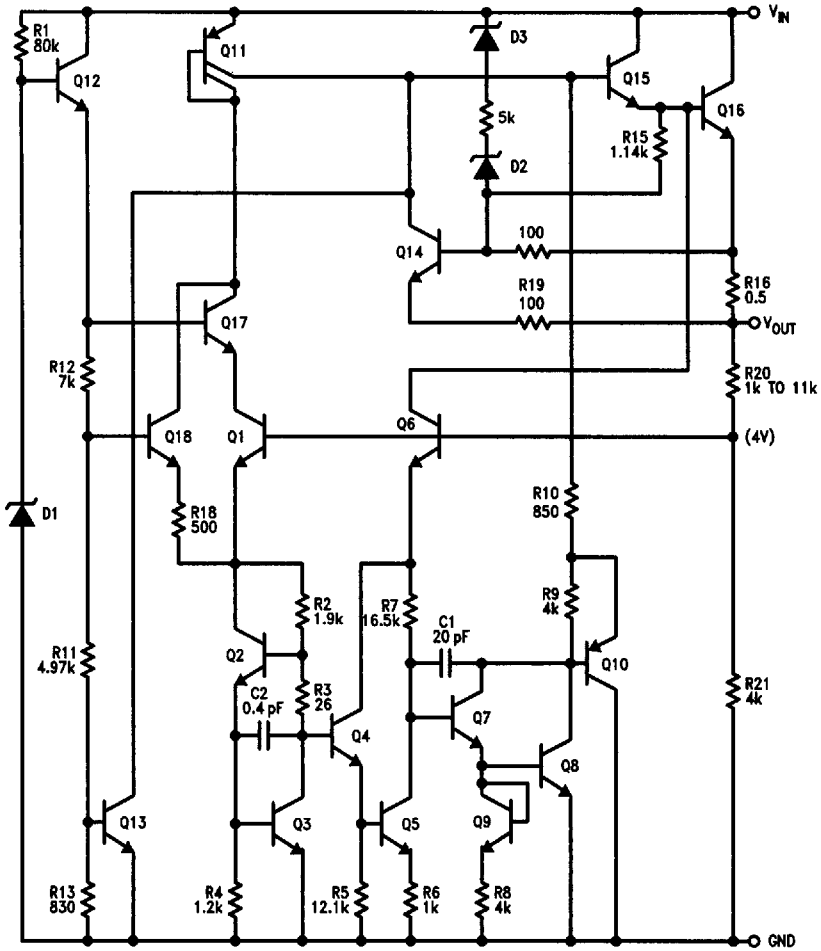

TL/H/10484-1

Typical Performance Characteristics

NATL SEMICON (LINEAR)

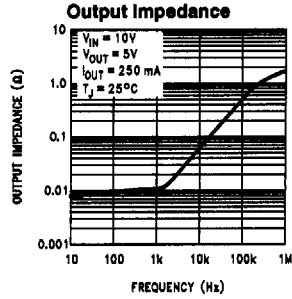
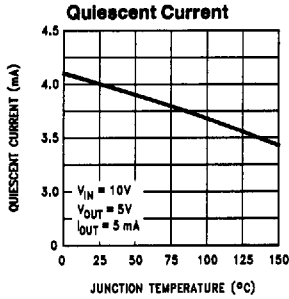
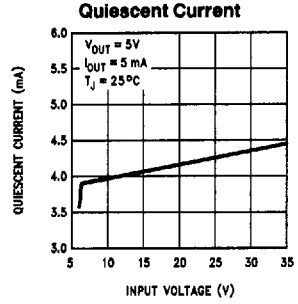
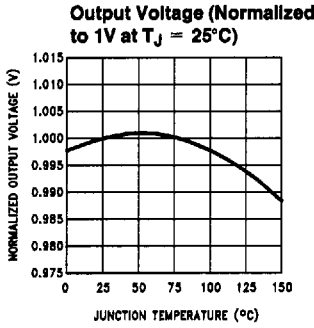
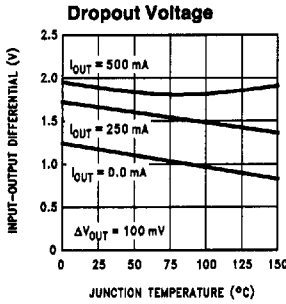
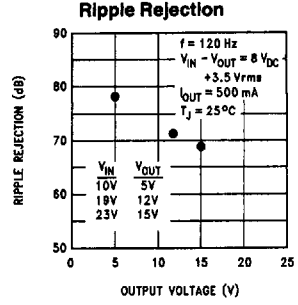
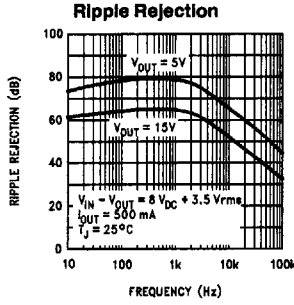
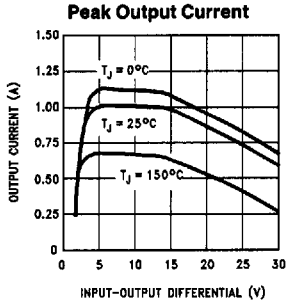

TL/H/10484-4

NATL SEMICOND (LINEAR)

Typical Performance Characteristics (Continued)

LM341 Series

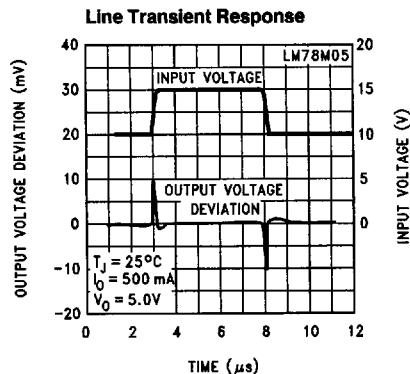

TL/H/10484-7

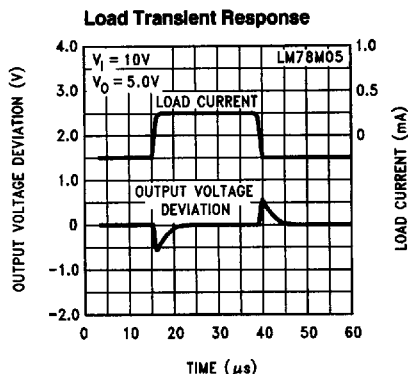

TL/H/10484-8

Design Considerations

The LM78MXX/LM341XX fixed voltage regulator series has built-in thermal overload protection which prevents the device from being damaged due to excessive junction temperature.

The regulators also contain internal short-circuit protection which limits the maximum output current, and safe-area protection for the pass transistor which reduces the short-circuit current as the voltage across the pass transistor is increased.

Although the internal power dissipation is automatically limited, the maximum junction temperature of the device must be kept below $+125^\circ\text{C}$ in order to meet data sheet specifications. An adequate heatsink should be provided to assure this limit is not exceeded under worst-case operating conditions (maximum input voltage and load current) if reliable performance is to be obtained.

Typical Application

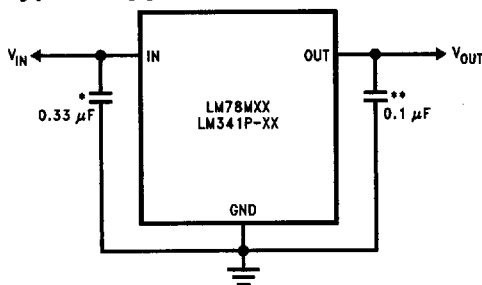

TL/H/10484-9

*Required if regulator input is more than 4 inches from input filter capacitor (or if no input filter capacitor is used).

**Optional for improved transient response.