

N-channel 1200 V, 1.65 Ω typ., 6 A, MDmesh K5 Power MOSFET in a TO-220 package

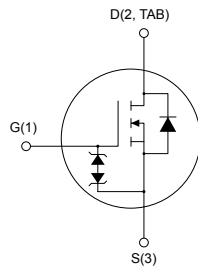
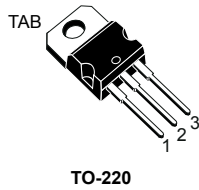

Features

Order code	V_{DS}	$R_{DS(on)}$ max.	I_D	P_{TOT}
STP8N120K5	1200 V	2.00 Ω	6 A	130 W

- Industry's lowest $R_{DS(on)}$ x area
- Industry's best FoM (figure of merit)
- Ultra-low gate charge
- 100% avalanche tested
- Zener-protected

Applications

- Switching applications

Description

This very high voltage N-channel Power MOSFET is designed using MDmesh™ K5 technology based on an innovative proprietary vertical structure. The result is a dramatic reduction in on-resistance and ultra-low gate charge for applications requiring superior power density and high efficiency.

Product status link

[STP8N120K5](#)

Product summary

Order code	STP8N120K5
Marking	8N120K5
Package	TO-220
Packing	Tube

1 Electrical ratings

Table 1. Absolute maximum ratings

Symbol	Parameter	Value	Unit
V_{GS}	Gate-source voltage	± 30	V
I_D	Drain current (continuous) at $T_C = 25\text{ }^\circ\text{C}$	6	A
	Drain current (continuous) at $T_C = 100\text{ }^\circ\text{C}$	3.5	A
$I_{DM}^{(1)}$	Drain current pulsed	12	A
P_{TOT}	Total dissipation at $T_C = 25\text{ }^\circ\text{C}$	130	W
$dv/dt^{(2)}$	Peak diode recovery voltage slope	4.5	V/ns
$dv/dt^{(3)}$	MOSFET dv/dt ruggedness	50	
T_j	Operating junction temperature range	-55 to 150	$^\circ\text{C}$
T_{stg}	Storage temperature range		

1. Pulse width limited by safe operating area
2. $I_{SD} \leq 6\text{ A}$, $di/dt \leq 100\text{ A}/\mu\text{s}$, $V_{DS\text{ peak}} \leq V_{(BR)DSS}$
3. $V_{DS} \leq 960\text{ V}$

Table 2. Thermal data

Symbol	Parameter	Value	Unit
$R_{thj-case}$	Thermal resistance junction-case	0.96	$^\circ\text{C}/\text{W}$
$R_{thj-amb}$	Thermal resistance junction-ambient	62.5	$^\circ\text{C}/\text{W}$

Table 3. Avalanche characteristics

Symbol	Parameter	Value	Unit
I_{AR}	Avalanche current, repetitive or not repetitive (pulse width limited by T_{jmax})	1.7	A
E_{AS}	Single-pulse avalanche energy (starting $T_J = 25\text{ }^\circ\text{C}$, $I_D = I_{AR}$, $V_{DD} = 50\text{ V}$)	415	mJ

2 Electrical characteristics

$T_C = 25\text{ °C}$ unless otherwise specified

Table 4. On-/off-states

Symbol	Parameter	Test conditions	Min.	Typ.	Max.	Unit
$V_{(BR)DSS}$	Drain-source breakdown voltage	$V_{GS} = 0\text{ V}$, $I_D = 1\text{ mA}$	1200			V
I_{DSS}	Zero gate voltage drain current	$V_{GS} = 0\text{ V}$, $V_{DS} = 1200\text{ V}$			1	μA
		$V_{GS} = 0\text{ V}$, $V_{DS} = 1200\text{ V}$ $T_C = 125\text{ °C}$ ⁽¹⁾			50	μA
I_{GSS}	Gate body leakage current	$V_{DS} = 0\text{ V}$, $V_{GS} = \pm 20\text{ V}$			± 10	μA
$V_{GS(th)}$	Gate threshold voltage	$V_{DS} = V_{GS}$, $I_D = 100\text{ }\mu\text{A}$	3	4	5	V
$R_{DS(on)}$	Static drain-source on-resistance	$V_{GS} = 10\text{ V}$, $I_D = 2.5\text{ A}$		1.65	2.00	Ω

1. Defined by design, not subject to production test.

Table 5. Dynamic characteristics

Symbol	Parameter	Test conditions	Min.	Typ.	Max.	Unit
C_{iss}	Input capacitance	$V_{DS} = 100\text{ V}$, $V_{GS} = 0\text{ V}$, $f = 1\text{ MHz}$	-	505	-	pF
C_{oss}	Output capacitance		-	44	-	pF
C_{riss}	Reverse transfer capacitance		-	0.4	-	pF
$C_{o(tr)}^{(1)}$	Time-related equivalent capacitance	$V_{DS} = 0\text{ to }960\text{ V}$, $V_{GS} = 0\text{ V}$	-	70	-	pF
$C_{o(er)}^{(2)}$	Energy-related equivalent capacitance		-	24	-	pF
R_g	Intrinsic gate resistance	$f = 1\text{ MHz}$, $I_D = 0\text{ A}$	-	7.7	-	Ω
Q_g	Total gate charge	$V_{DD} = 960\text{ V}$, $I_D = 5\text{ A}$	-	13.7	-	nC
Q_{gs}	Gate-source charge	$V_{GS} = 0\text{ to }10\text{ V}$	-	3.6	-	nC
Q_{gd}	Gate-drain charge	(see Figure 14. Test circuit for gate charge behavior)	-	7.1	-	nC

- $C_{o(tr)}$ is a constant capacitance value that gives the same charging time as C_{oss} while V_{DS} is rising from 0 to 80% V_{DSS} .
- $C_{o(er)}$ is a constant capacitance value that gives the same stored energy as C_{oss} while V_{DS} is rising from 0 to 80% V_{DSS} .

Table 6. Switching times

Symbol	Parameter	Test conditions	Min.	Typ.	Max.	Unit
$t_{d(on)}$	Turn-on delay time	$V_{DD} = 600\text{ V}$, $I_D = 2.5\text{ A}$, $R_G = 4.7\text{ }\Omega$, $V_{GS} = 10\text{ V}$	-	15.5	-	ns
t_r	Rise time		-	11	-	ns
$t_{d(off)}$	Turn-off delay time	(see Figure 13. Test circuit for resistive load switching times and Figure 18. Switching time waveform)	-	40	-	ns
t_f	Fall time		-	27	-	ns

Table 7. Source-drain diode

Symbol	Parameter	Test conditions	Min.	Typ.	Max.	Unit
I_{SD}	Source-drain current		-		6	A
$I_{SDM}^{(1)}$	Source-drain current (pulsed)		-		12	A
$V_{SD}^{(2)}$	Forward on voltage	$I_{SD} = 5\text{ A}$, $V_{GS} = 0\text{ V}$	-		1.5	V
t_{rr}	Reverse recovery time	$I_{SD} = 5\text{ A}$, $V_{DD} = 60\text{ V}$, $di/dt = 100\text{ A}/\mu\text{s}$ (see Figure 15. Test circuit for inductive load switching and diode recovery times)	-	327		ns
Q_{rr}	Reverse recovery charge		-	3		μC
I_{RRM}	Reverse recovery current		-	18.4		A
t_{rr}	Reverse recovery time	$I_{SD} = 5\text{ A}$, $V_{DD} = 60\text{ V}$, $di/dt = 100\text{ A}/\mu\text{s}$, $T_j = 150\text{ }^\circ\text{C}$ (see Figure 15. Test circuit for inductive load switching and diode recovery times)	-	485		ns
Q_{rr}	Reverse recovery charge		-	3.9		μC
I_{RRM}	Reverse recovery current		-	16		A

1. Pulse width limited by safe operating area.
2. Pulsed: pulse duration = 300 μs , duty cycle 1.5%.

Table 8. Gate-source Zener diode

Symbol	Parameter	Test conditions	Min.	Typ.	Max.	Unit
$V_{(BR)GSO}$	Gate-source breakdown voltage	$I_{GS} = \pm 1\text{ mA}$, $I_D = 0\text{ A}$	± 30	-	-	V

The built-in back-to-back Zener diodes are specifically designed to enhance the ESD performance of the device. The Zener voltage facilitates efficient and cost-effective device integrity protection, thus eliminating the need for additional external componentry.

2.1 Electrical characteristics (curves)

Figure 1. Safe operating area

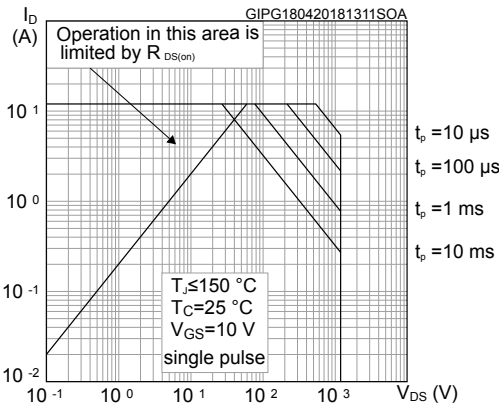

Figure 2. Thermal impedance

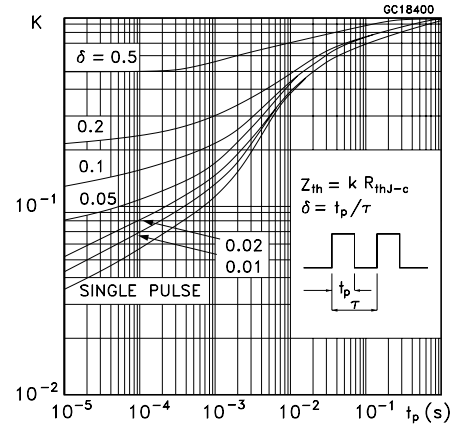

Figure 3. Output characteristics

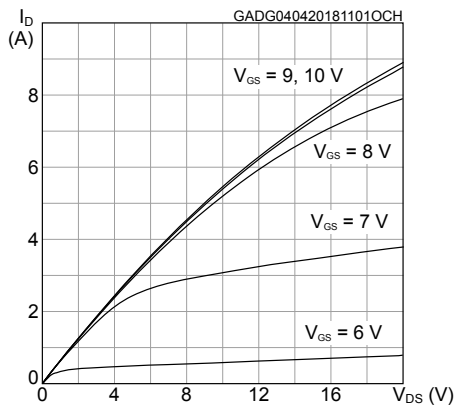

Figure 4. Transfer characteristics

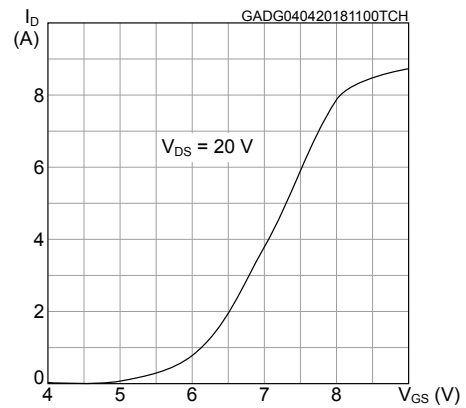

Figure 5. Gate charge vs gate-source voltage

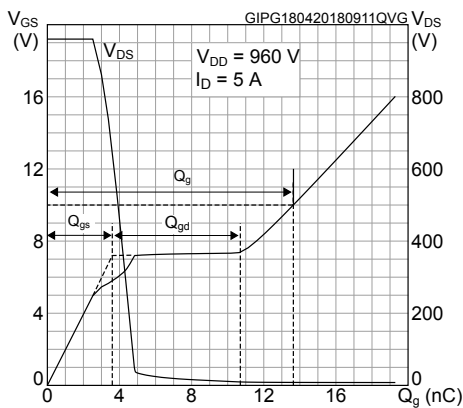

Figure 6. Static drain-source on-resistance

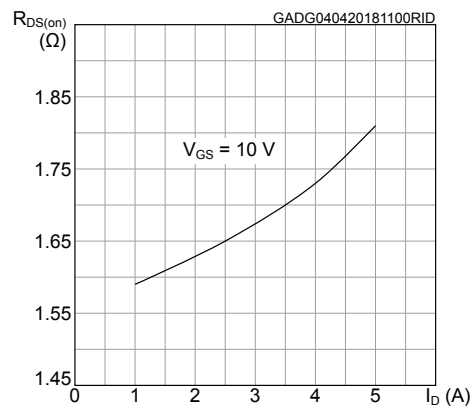

Figure 7. Capacitance variations

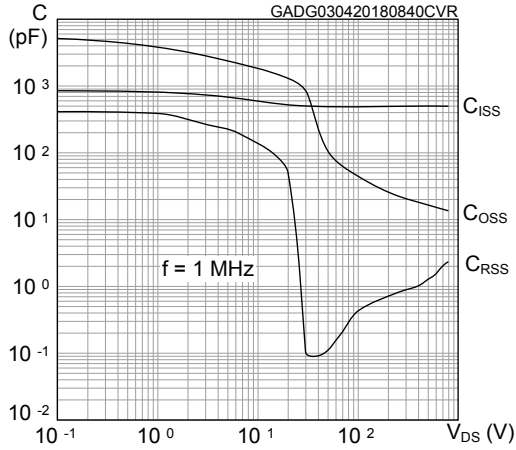

Figure 8. Normalized gate threshold voltage vs temperature

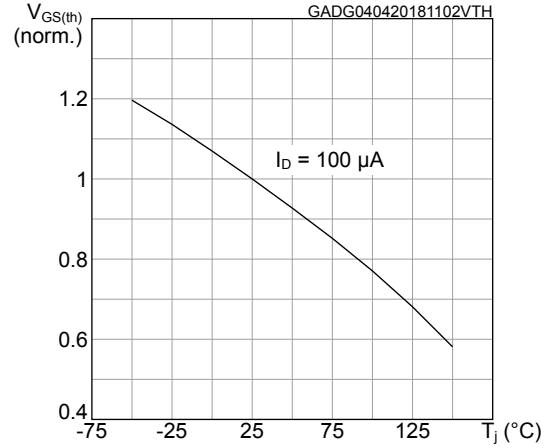

Figure 9. Normalized on-resistance vs temperature

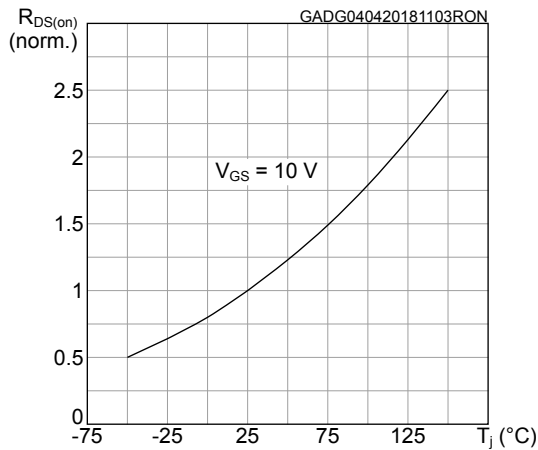

Figure 10. Normalized $V_{(BR)DSS}$ vs temperature

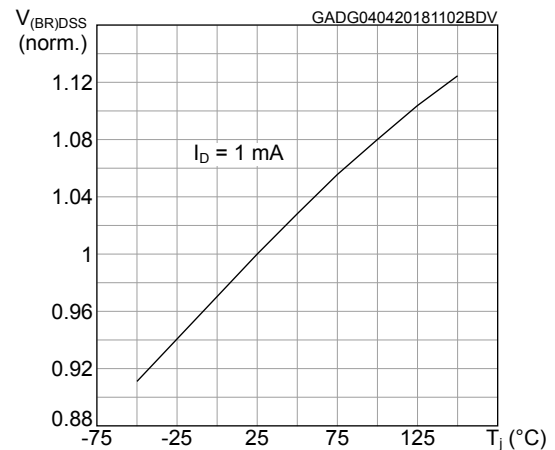

Figure 11. Source-drain diode forward characteristics

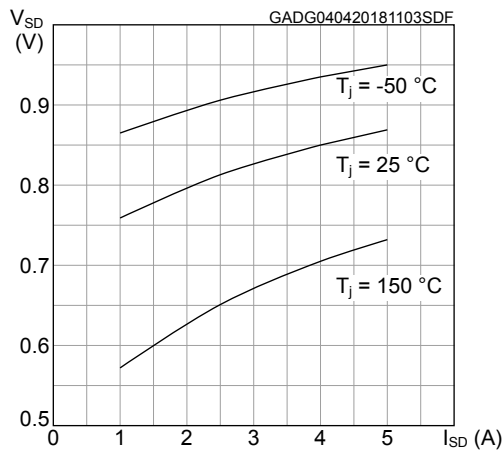
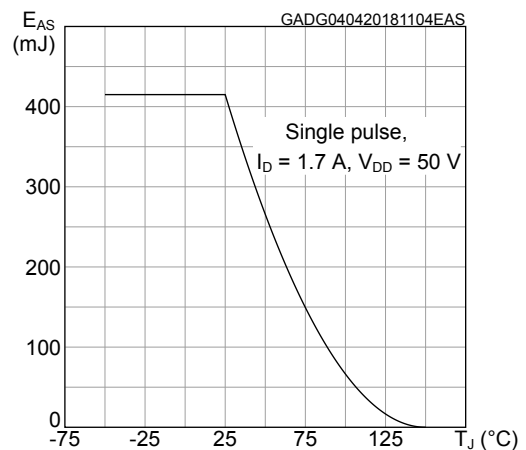
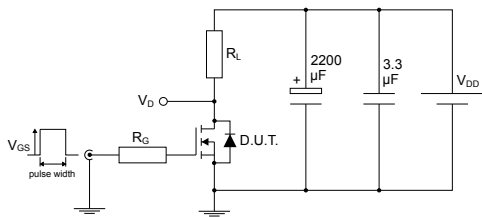

Figure 12. Maximum avalanche energy vs starting T_J



3 Test circuits

Figure 13. Test circuit for resistive load switching times

AM01468v1

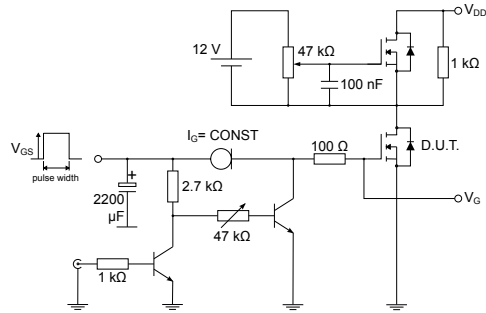
Figure 14. Test circuit for gate charge behavior

AM01469v1

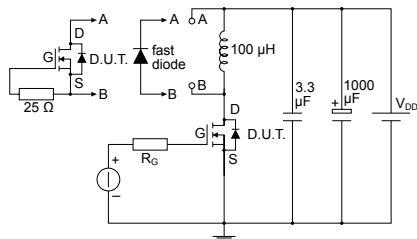
Figure 15. Test circuit for inductive load switching and diode recovery times

AM01470v1

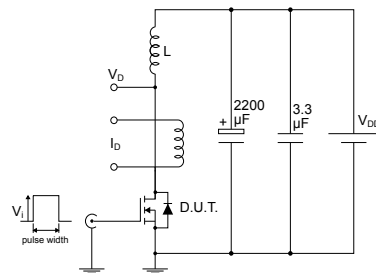
Figure 16. Unclamped inductive load test circuit

AM01471v1

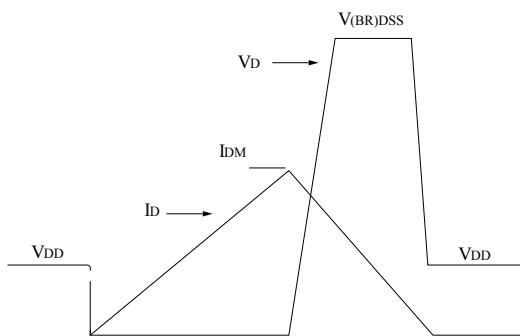
Figure 17. Unclamped inductive waveform

AM01472v1

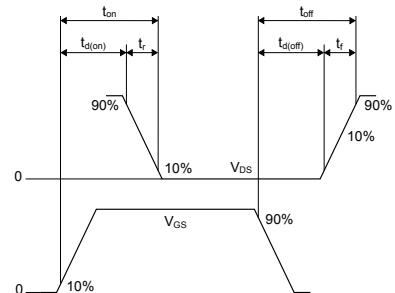
Figure 18. Switching time waveform

AM01473v1

4 Package information

In order to meet environmental requirements, ST offers these devices in different grades of ECOPACK® packages, depending on their level of environmental compliance. ECOPACK® specifications, grade definitions and product status are available at: www.st.com. ECOPACK® is an ST trademark.

4.1 TO-220 type A package information

Figure 19. TO-220 type A package outline

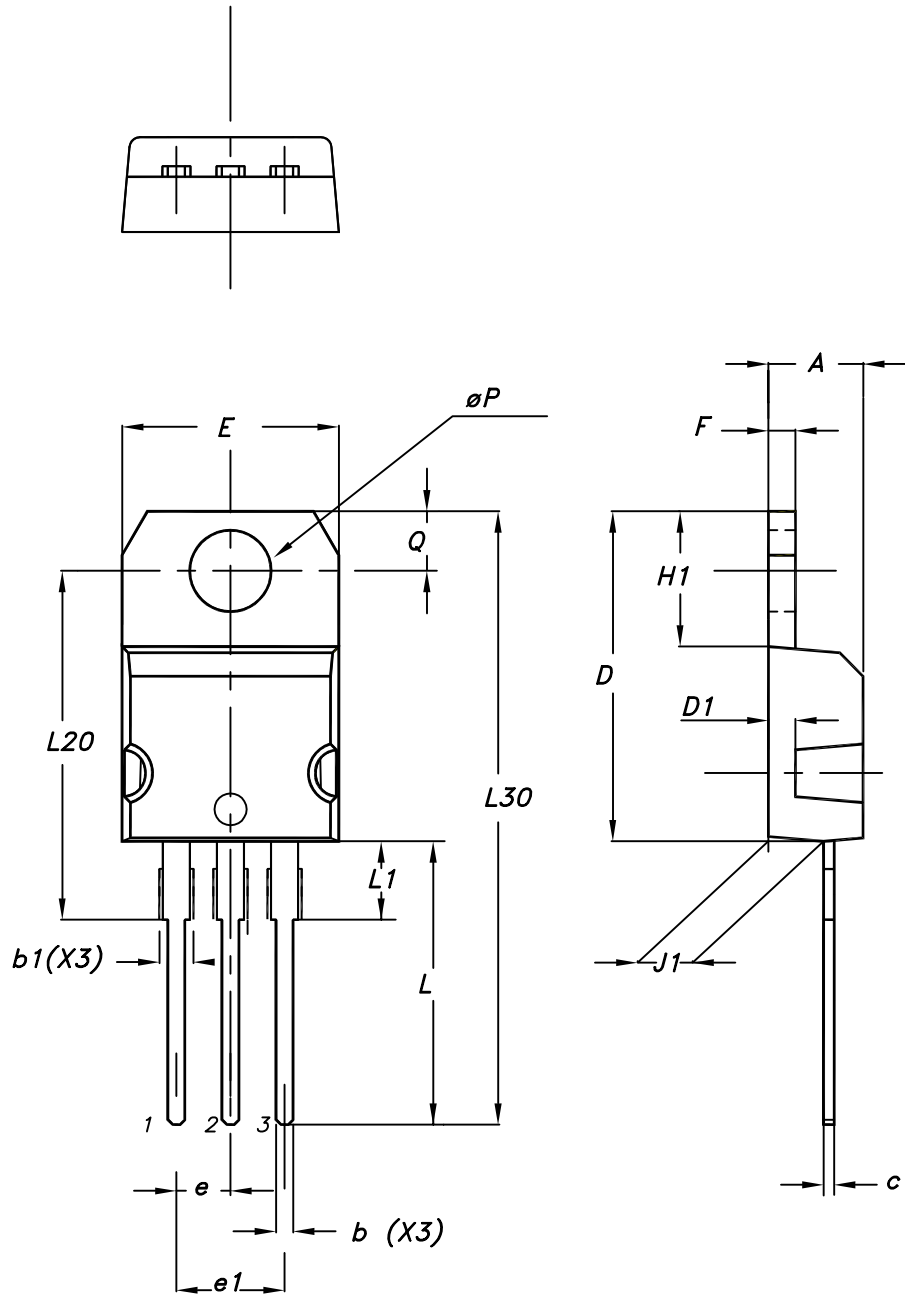

0015988_typeA_Rev_21

Table 9. TO-220 type A package mechanical data

Dim.	mm		
	Min.	Typ.	Max.
A	4.40		4.60
b	0.61		0.88
b1	1.14		1.55
c	0.48		0.70
D	15.25		15.75
D1		1.27	
E	10.00		10.40
e	2.40		2.70
e1	4.95		5.15
F	1.23		1.32
H1	6.20		6.60
J1	2.40		2.72
L	13.00		14.00
L1	3.50		3.93
L20		16.40	
L30		28.90	
øP	3.75		3.85
Q	2.65		2.95

Revision history

Table 10. Document revision history

Date	Version	Changes
05-Apr-2018	1	Initial release. The document status is preliminary data.
18-Apr-2018	2	Modified Figure 1. Safe operating area , Table 5. Dynamic characteristics and Figure 5. Gate charge vs gate-source voltage . Minor text changes.
30-May-2018	3	Document status promoted from preliminary to production data.

Contents

1	Electrical ratings	2
2	Electrical characteristics	3
2.1	Electrical characteristics (curves)	5
3	Test circuits	7
4	Package information	8
4.1	TO-220 type A package information	8
	Revision history	11

IMPORTANT NOTICE – PLEASE READ CAREFULLY

STMicroelectronics NV and its subsidiaries (“ST”) reserve the right to make changes, corrections, enhancements, modifications, and improvements to ST products and/or to this document at any time without notice. Purchasers should obtain the latest relevant information on ST products before placing orders. ST products are sold pursuant to ST’s terms and conditions of sale in place at the time of order acknowledgement.

Purchasers are solely responsible for the choice, selection, and use of ST products and ST assumes no liability for application assistance or the design of Purchasers’ products.

No license, express or implied, to any intellectual property right is granted by ST herein.

Resale of ST products with provisions different from the information set forth herein shall void any warranty granted by ST for such product.

ST and the ST logo are trademarks of ST. All other product or service names are the property of their respective owners.

Information in this document supersedes and replaces information previously supplied in any prior versions of this document.

© 2018 STMicroelectronics – All rights reserved