

Core **E38/8/25 + PLT38/25/3.8**

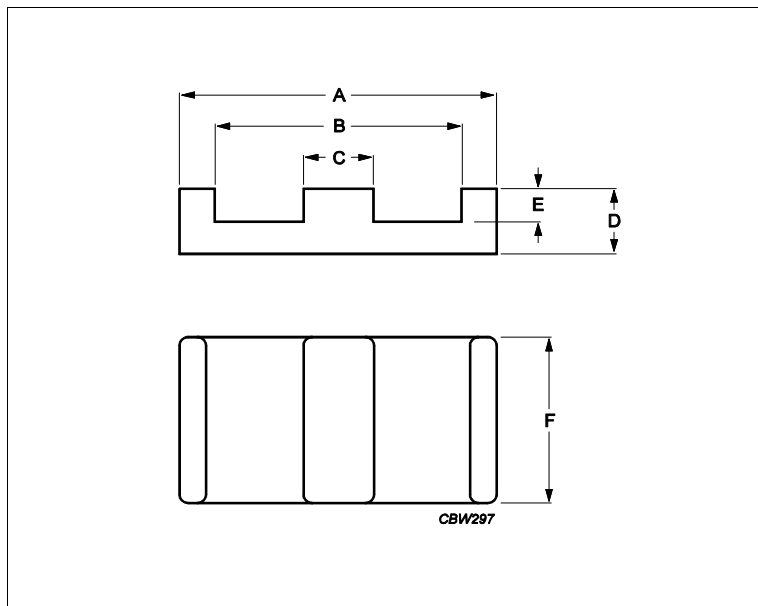

Effective parameters				
	Parameter	Value	Unit	
	$\Sigma(I/A)$	core factor (C1)	0.226	mm ⁻¹
	Ve	effective volume	8460	mm ³
	Le	effective length	43.7	mm
	Ae	effective area	194	mm ²
	Amin	minimum area	194	mm ²
	m	E38/8/25	≈ 25	g/pcs
	m	PLT38/25/3.8	≈ 18	g/pcs

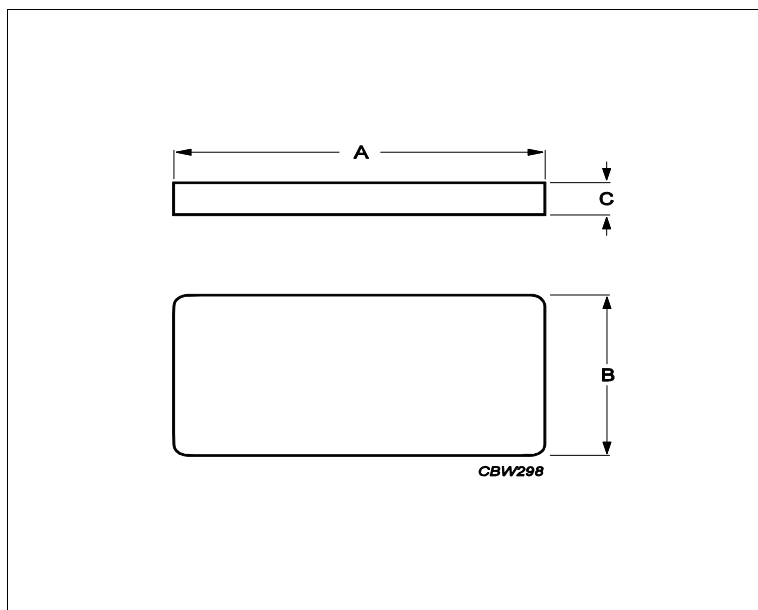

Dimensions for product: E38/8/25						
	Nom	Tol +	Tol -	Max	Min	Unit
A	38.10	0.76	0.76	38.86	37.34	mm
B					30.23	mm
C	7.60	0.20	0.20	7.80	7.40	mm
D	8.26	0.13	0.13	8.39	8.13	mm
E	4.45	0.13	0.13	4.58	4.32	mm
F	25.40	0.51	0.51	25.91	24.89	mm
Dimensions for product: PLT38/25/3.8						
	Nom	Tol +	Tol -	Max	Min	Unit
A	38.10	0.76	0.76	38.86	37.34	mm
B	25.40	0.51	0.51	25.91	24.89	mm

Core **E38/8/25 + PLT38/25/3.8**

Dimensions for product: PLT38/25/3.8						
	Nom	Tol +	Tol -	Max	Min	Unit
C	3.81	0.13	0.13	3.94	3.68	mm

Inductance factor					
Material	Value	Tol +	Tol -	Unit	
3C92	7150	25%	25%	nH/turns ²	
3C95	11200	25%	25%	nH/turns ²	
3C96	8200	25%	25%	nH/turns ²	
3C97	11200	25%	25%	nH/turns ²	
3F36	5900	25%	25%	nH/turns ²	
3F4	4600	25%	25%	nH/turns ²	

Power loss: 3C92				
Measuring conditions			Max	Unit
100 kHz	200 mT	100 °C	4.200	W/set

Power loss: 3C95				
Measuring conditions			Max	Unit
100 kHz	200 mT	100 °C	4.100	W/set
100 kHz	200 mT	25 °C	4.400	W/set

Power loss: 3C96				
Measuring conditions			Max	Unit
100 kHz	200 mT	100 °C	3.800	W/set
400 kHz	50 mT	100 °C	1.500	W/set

Power loss: 3C97				
Measuring conditions			Max	Unit
100 kHz	200 mT	60 °C	4.200	W/set
100 kHz	200 mT	120 °C	4.100	W/set
100 kHz	200 mT	140 °C	5.100	W/set

Power loss: 3F36				
Measuring conditions			Max	Unit
500 kHz	50 mT	100 °C	1.300	W/set
500 kHz	100 mT	100 °C	9.700	W/set

Power loss: 3F4				
Measuring conditions			Max	Unit
1000 kHz	30 mT	100 °C	2.500	W/set
3000 kHz	10 mT	100 °C	4.200	W/set

Bsat					
Measuring conditions			Material	Min	Unit
25 kHz	250 A/m	100 °C	3C92	370	mT
25 kHz	250 A/m	100 °C	3C95	330	mT
25 kHz	250 A/m	100 °C	3C96	340	mT

Core **E38/8/25 + PLT38/25/3.8**

25 kHz	250 A/m	100 °C	3C97	330	mT
25 kHz	250 A/m	100 °C	3F36	340	mT
25 kHz	250 A/m	100 °C	3F4	330	mT