



Typical Applications

The HMC560LM3 is ideal for:

- Test Equipment & Sensors
- Point-to-Point Radios
- Point-to-Multi-Point Radios
- Military & Space

Features

- Wide IF Bandwidth: DC - 17 GHz
- Input IP3: +21 dBm
- High LO/RF Isolation: 35 dB
- Passive Double Balanced Topology
- Leadless RoHS Compliant SMT Package, 25 mm²

Functional Diagram

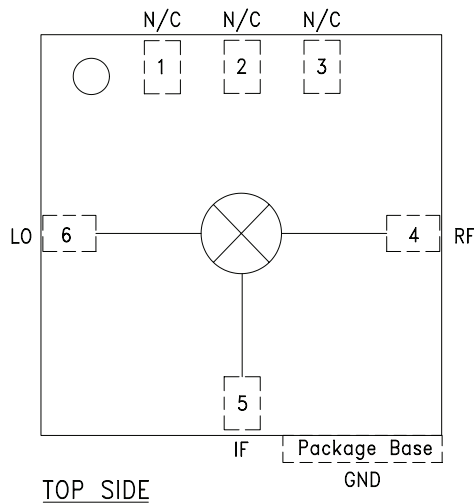

General Description

The HMC560LM3 is a 24 - 40 GHz passive, double-balanced MMIC mixer in a SMT leadless chip carrier package. The mixer is fabricated in a GaAs MESFET process, and can be used as a downconverter or upconverter. The wide operating bandwidth allows this device to be used across multiple radio bands with a common platform. Excellent isolations are provided by on-chip baluns. The HMC560LM3 requires no external components and no DC bias. All data is with the non-hermetic, epoxy sealed LM3 package mounted in a 50 Ohm test fixture. Utilizing the HMC560LM3 eliminates the need for wirebonding, thereby providing a consistent connection interface for the customer, and allowing the use of surface mount manufacturing techniques.

Electrical Specifications, $T_A = +25^\circ \text{C}$, $IF = 1 \text{ GHz}$, $LO = +13 \text{ dBm}^*$

Parameter	Min.	Typ.	Max.	Min.	Typ.	Max.	Units
Frequency Range, RF & LO	24 - 36			36 - 40			GHz
Frequency Range, IF	DC - 17			DC - 17			GHz
Conversion Loss		10	12		11	14	dB
Noise Figure (SSB)		10	12		11	14	dB
LO to RF Isolation	25	35		22	28		dB
LO to IF Isolation	23	30		18	25		dB
RF to IF Isolation	16	20		20	25		dB
IP3 (Input)		18			21		dBm
IP2 (Input)		50			40		dBm
1 dB Compression (Input)		18			20		dBm

* Unless otherwise noted, all measurements performed as downconverter



Conversion Gain vs. Temperature @ LO = +13 dBm

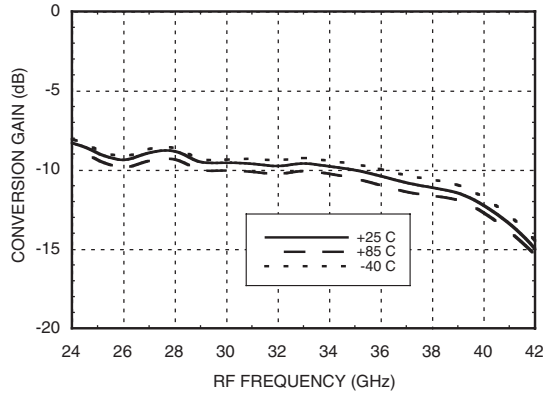

Isolation @ LO +13 dBm

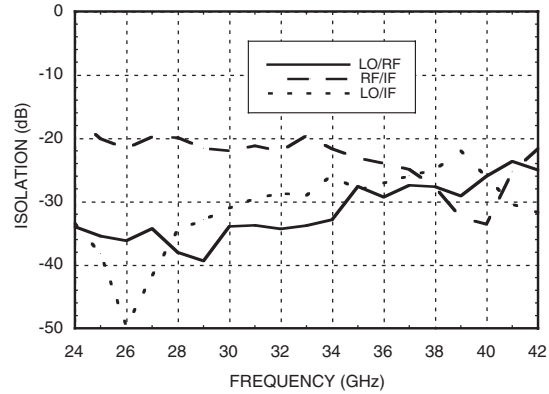

Conversion Gain vs. LO Drive

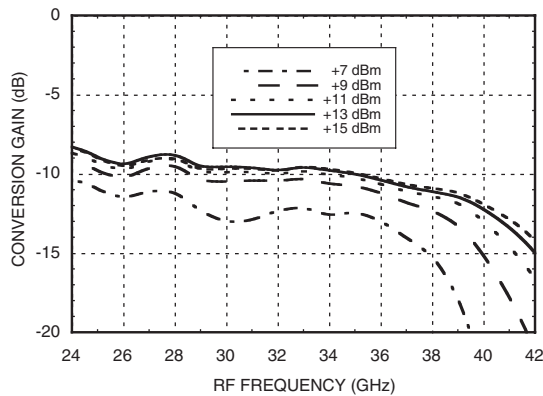

IF Bandwidth @ LO = +13 dBm

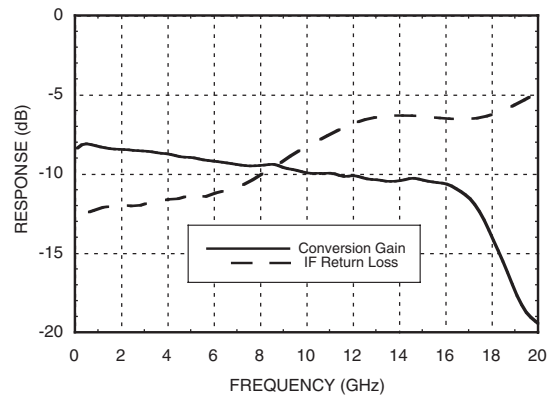

Upconverter Performance Conversion Gain @ LO = +13 dBm

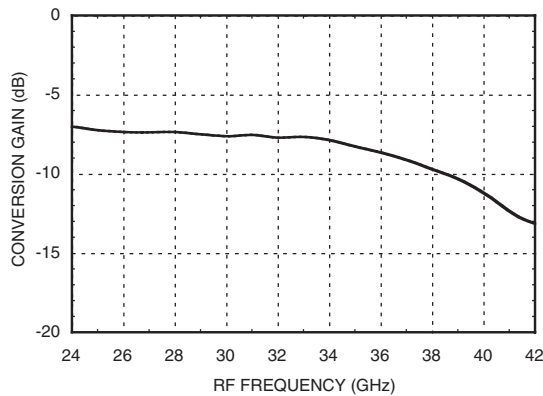

Return Loss @ LO = +13 dBm

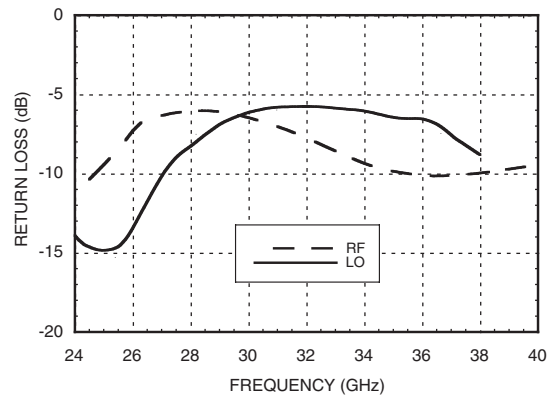



Input IP3 vs. LO Drive*

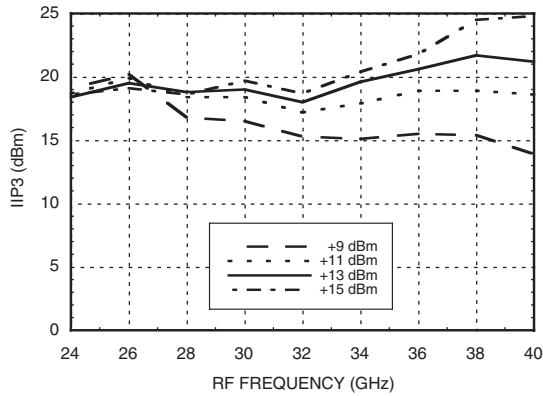

Input IP3 vs. Temperature @ LO = +13 dBm*

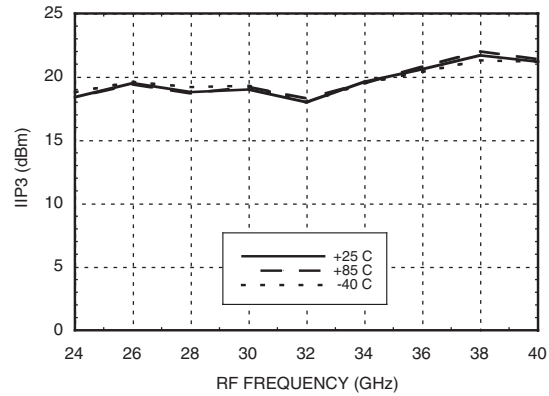

Input IP2 vs. LO Drive*

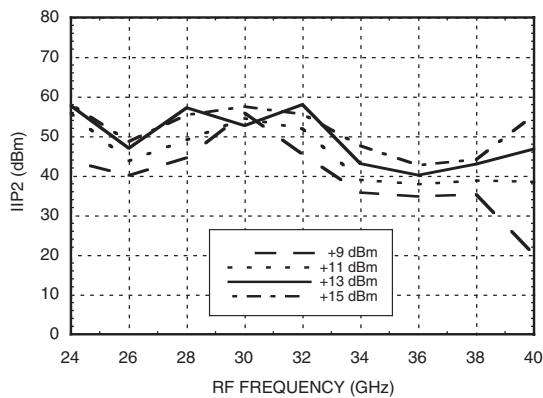

Input IP2 vs. Temperature @ LO = +13 dBm*

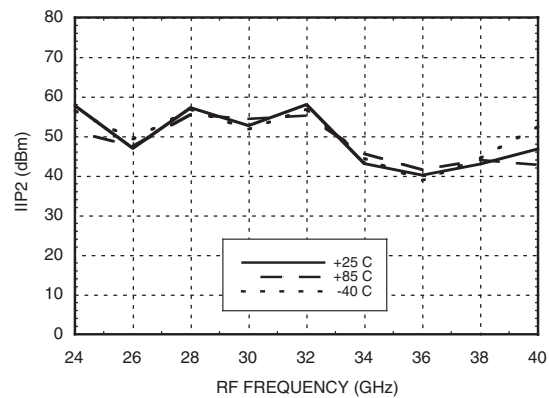

**Upconverter Performance
Input IP3 @ LO = +13 dBm**

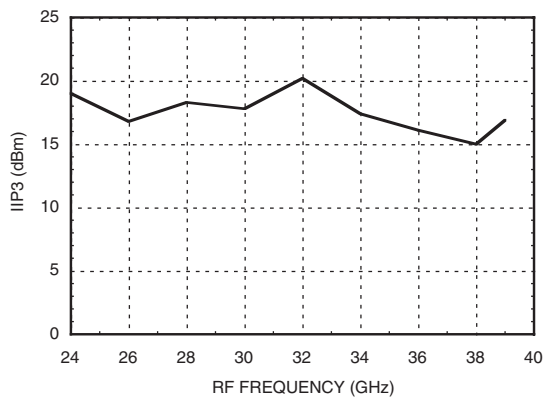

Input P1dB vs. Temperature @ LO = +13 dBm

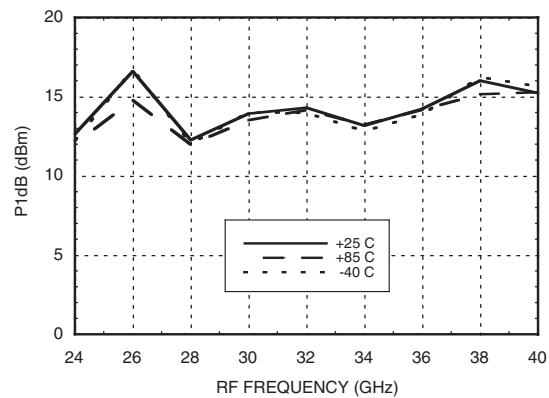

* Two-tone input power = -10 dBm each tone, 1 MHz spacing.



Absolute Maximum Ratings

RF / IF Input	+25 dBm
LO Drive	+23 dBm
IF DC Current	±2 mA
Channel Temperature	150 °C/W
Continuous Pdiss (T= 85 °C) (derate 5.3 mW/ °C above 85 °C)	0.344 W
Thermal Resistance (R _{TH}) (channel to package bottom)	188 °C/W
Storage Temperature	-65 to +150 °C
Operating Temperature	-55 to +85 °C

MxN Spurious Outputs as a Down Converter

mRF	nLO				
	0	1	2	3	4
0	xx	-5	5		
1	3	0	25		
2	58	48	49	58	
3		78	73	63	83
4			88	85	89

RF = 24 GHz @ -10 dBm
LO = 25 GHz @ +13 dBm
All values in dBc below IF output power level.



**ELECTROSTATIC SENSITIVE DEVICE
OBSERVE HANDLING PRECAUTIONS**

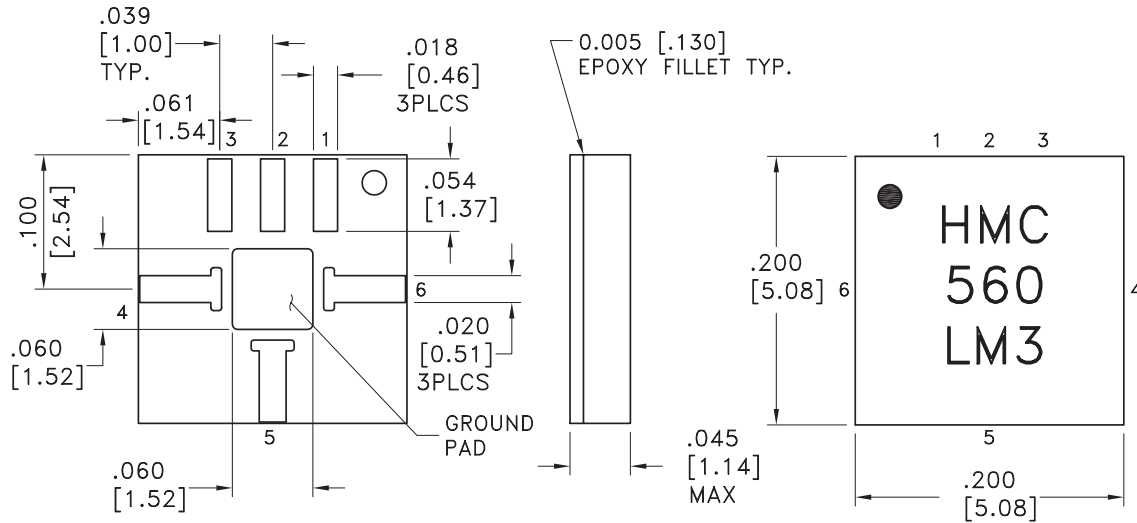

Outline Drawing



- NOTES:
1. MATERIAL: PLASTIC
 2. PLATING: GOLD OVER NICKEL
 3. ALL DIMENSIONS IN INCHES (MILLIMETERS)
 4. ALL TOLERANCES ARE ±0.005 (±0.13)
 5. ALL GROUNDS MUST BE SOLDERED TO PCB RF GROUND
 6. ● INDICATES PIN 1

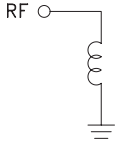
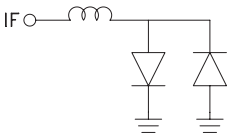
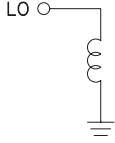

Pin Descriptions

Pin Number	Function	Description	Interface Schematic
1, 2, 3	N/C	This pin may be connected to the PCB ground or left unconnected.	
4	RF	This pin is DC coupled and matched to 50 Ohm from 24 to 40 GHz.	
5	IF	This pin is DC coupled. For applications not requiring operation to DC, this port should be DC blocked externally using a series capacitor whose value has been chosen to pass the necessary IF frequency range. For operation to DC, this pin must not source or sink more than 2 mA of current or part non-function and possible part failure will result.	
6	LO	This pin is DC coupled and matched to 50 Ohm from 24 to 40 GHz.	
	GND	Package base must be soldered to PCB RF ground.	

Evaluation PCB

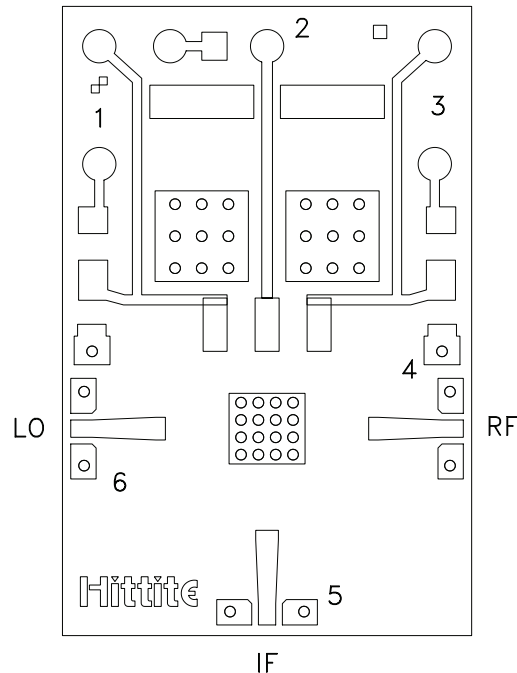

The grounded Co-Planar Wave Guide (CPWG) PCB input/output transitions allow use of Ground-Signal-Ground (GSG) probes for testing. Suggested probe pitch is 400 μ m (16 mils). Alternatively, the board can be mounted in a metal housing with 2.4 mm coaxial connectors.

Evaluation Circuit Board Layout Design Details

Layout Technique	Micro Strip to CPWG
Material	Rogers 4003 with 1/2 oz. Cu
Dielectric Thickness	0.008" (0.20 mm)
Microstrip Line Width	0.018" (0.46 mm)
CPWG Line Width	0.016" (0.41 mm)
CPWG Line to GND Gap	0.005" (0.13 mm)
Ground Via Hole Diameter	0.008" (0.20 mm)

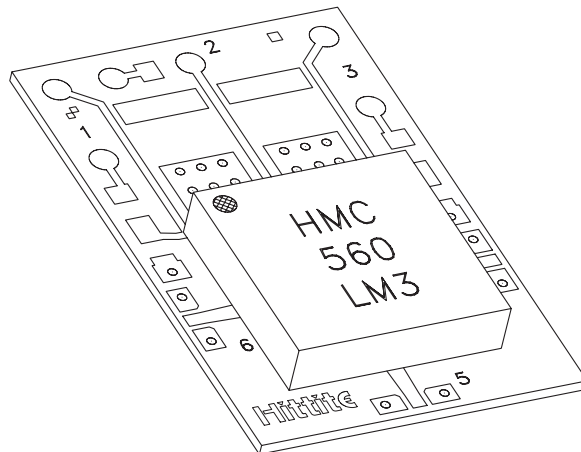

LM3 package mounted to evaluation PCB

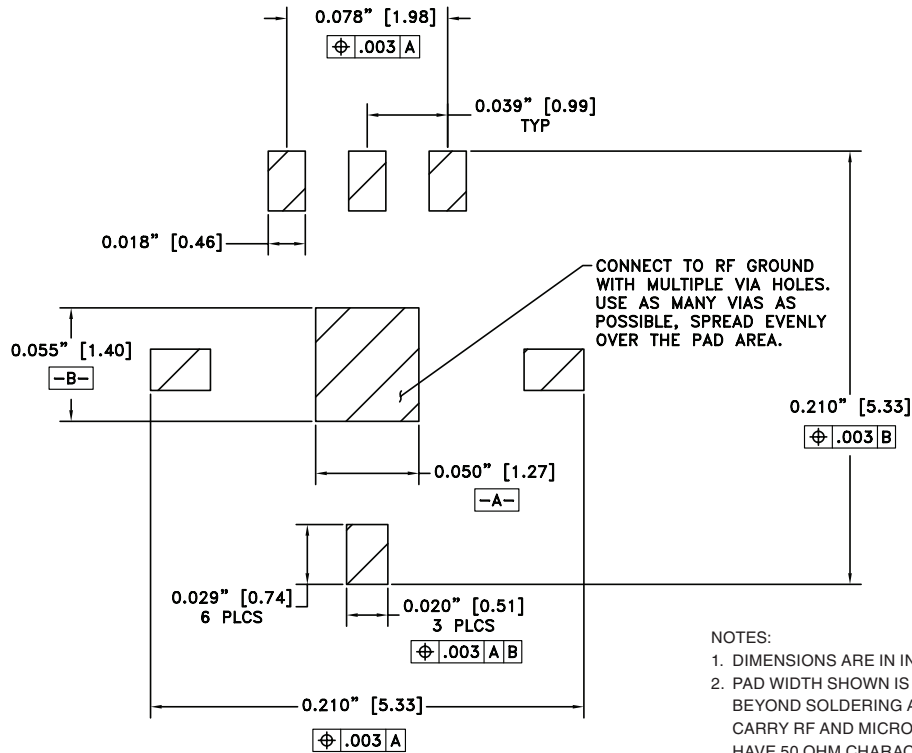
Suggested LM3 PCB Land Pattern



Recommended SMT Attachment Technique

Preparation & Handling of the LM3 Millimeterwave Package for Surface Mounting

The HMC LM3 package was designed to be compatible with high volume surface mount PCB assembly processes. The LM3 package requires a specific mounting pattern to allow proper mechanical attachment and to optimize electrical performance at millimeterwave frequencies. This PCB layout pattern can be found on each LM3 product data sheet. It can also be provided as an electronic drawing upon request from Hittite Sales & Application Engineering.

Follow these precautions to avoid permanent damage:

Cleanliness: Observe proper handling procedures to ensure clean devices and PCBs. LM3 devices should remain in their original packaging until component placement to ensure no contamination or damage to RF, DC & ground contact areas.

Static Sensitivity: Follow ESD precautions to protect against ESD strikes.

General Handling: Handle the LM3 package on the top with a vacuum collet or along the edges with a sharp pair of bent tweezers. Avoiding damaging the RF, DC, & ground contacts on the package bottom. Do not apply excess pressure to the top of the lid.

Solder Materials & Temperature Profile: Follow the information contained in the application note. Hand soldering is not recommended. Conductive epoxy attachment is not recommended.

Solder Paste: Solder paste should be selected based on the user's experience and be compatible with the metallization systems used. See the LM3 data sheet Outline drawing for pin & ground contact metallization schemes.

Solder Paste Application: Solder paste is generally applied to the PCB using either a stencil printer or dot placement. The volume of solder paste will be dependent on PCB and component layout and should be controlled to ensure consistent mechanical & electrical performance. Excess solder may create unwanted electrical parasitics at high frequencies.

Solder Reflow: The soldering process is usually accomplished in a reflow oven but may also use a vapor phase process. A solder reflow profile is suggested above.

Prior to reflowing product, temperature profiles should be measured using the same mass as the actual assemblies. The thermocouple should be moved to various positions on the board to account for edge and corner effects and varying component masses. The final profile should be determined by mounting the thermocouple to the PCB at the location of the device.

Follow solder paste and oven vendor's recommendations when developing a solder reflow profile. A standard profile will have a steady ramp up from room temperature to the pre-heat temperature to avoid damage due to thermal shock. Allow enough time between reaching pre-heat temperature and reflow for the solvent in the paste to evaporate and the flux to completely activate. Reflow must then occur prior to the flux being completely driven off. The duration of peak reflow temperature should not exceed 15 seconds. Packages have been qualified to withstand a peak temperature of 235°C for 15 seconds. Verify that the profile will not expose device to temperatures in excess of 235°C.

Cleaning: A water-based flux wash may be used.

