

# FCC Part 15C Test Report

**Product Name** : GSM/GPRS Wireless Data Module  
**Model Name** : SIM800H

Prepared for:

**Shanghai Simcom Ltd.**  
**Building A, SIM Technology Building, No.633, Jinzhong Road,**  
**Changning District, Shanghai P.R. China**

Prepared by:

**Unilab (Shanghai) Co., Ltd.**  
**FCC 2.948 register number is 714465**  
**No. 1350, Lianxi Rd. Pudong New District, Shanghai, China**  
**TEL: +86-21-50275125**  
**FAX: +86-21-50275126**

**Report Number** : UL15820130723FCC24-2  
**Date of Report** : 2013-07-30  
**Date of Test** : 2013-07-23~2013-07-29

**Notes :**

The test results only relate to these samples which have been tested.  
Partly using this report will not be admitted unless been allowed by Unilab.  
Unilab is only responsible for the complete report with the reported stamp of Unilab.

**Applicant:** Shanghai Simcom Ltd.  
Building A, SIM Technology Building, No.633, Jinzhong Road,  
Changning District, Shanghai P.R. China

**Manufacturer:** Shanghai Simcom Ltd.  
Building A, SIM Technology Building, No.633, Jinzhong Road,  
Changning District, Shanghai P.R. China

**Product Name:** GSM/GPRS Wireless Data Module

**Brand Name:** SIMCom

**Model Name:** SIM800H

**FCC ID:** UDV-2013072401

**Serial Number:** N/A

**Technical Data:** AC input: AC 100~240V 50/60Hz  
Rated voltage: 3.6V~4.2V

**Date of Receipt:** 2013-07-23

**Test Standard:** FCC CFR Title 47 Part 15: 2010  
ANSI C 63.4: 2009  
DA 00705

**Test Result:** Complied

**Date of Test** 2013-07-23~2013-07-29

Prepared by :   
(Technical Engineer: Flame Wang)

Reviewed by :   
(Senior Engineer: Forest Cao)

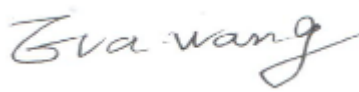
Approved by :   
(Supervisor: Eva Wang)

## TABLE OF CONTENTS

<b>1.</b>	<b>GENERAL INFORMATION .....</b>	<b>5</b>
	1.1 EUT DESCRIPTION .....	5
	1.2 TEST MODE .....	5
<b>2.</b>	<b>TEST METHODOLOGY .....</b>	<b>6</b>
	2.1 EUT CONFIGURATION .....	6
	2.2 EUT EXERCISE .....	6
	2.3 GENERAL TEST PROCEDURES .....	6
<b>3.</b>	<b>TECHNIACL SUMMARY .....</b>	<b>8</b>
	3.1 SUMMARY OF STANDARDS AND TEST RESULTS .....	8
	3.2 TEST UNCERTAINTY .....	8
	3.3 TEST EQUIPMENT LIST .....	8
	3.4 TEST FACILITY .....	9
	3.5 TEST SETUP CONFIGURATION .....	9
<b>4.</b>	<b>CHANNEL SEPARATION .....</b>	<b>10</b>
	4.1 TEST SETUP .....	10
	4.2 LIMITS .....	10
	4.3 TEST PROCEDURE .....	10
	4.4 TEST RESULT .....	11
<b>5.</b>	<b>MINIMUM HOPPING CHANNELS.....</b>	<b>12</b>
	5.1 TEST SETUP .....	12
	5.2 LIMITS.....	12
	5.3 TEST PROCEDURE .....	12
	5.4 TEST RESULT .....	13
<b>6.</b>	<b>OCCUPIED BANDWIDTH .....</b>	<b>14</b>
	6.1 TEST SETUP .....	14
	6.2 LIMITS.....	14
	6.3 TEST PROCEDURE .....	14
	6.4 TEST RESULTS .....	15
<b>7.</b>	<b>DWELL TIME.....</b>	<b>19</b>
	7.1 TEST SETUP .....	19
	7.2 LIMITS.....	19
	7.3 TEST PROCEDURE .....	19
	7.4 TEST RESULTS .....	20
<b>8.</b>	<b>PEAK OUTPUT POWER (CONDUCTION) .....</b>	<b>24</b>
	8.1 TEST SETUP .....	24
	8.2 LIMITS.....	24
	8.3 TEST PROCEDURE .....	24
	8.4 RESULTS & PERFORMANCE .....	25
<b>9.</b>	<b>SPURIOUS EMISSIONS (CONDUCTION).....</b>	<b>29</b>
	9.1 TEST SETUP .....	29
	9.2 LIMITS.....	29
	9.3 TEST PROCEDURE .....	29
	9.4 RESULTS & PERFORMANCE .....	30
<b>10.</b>	<b>BAND EDGE MEASUREMENT.....</b>	<b>42</b>
	10.1 TEST SETUP .....	42
	10.2 LIMITS.....	42
	10.3 TEST PROCEDURE .....	42
	10.4 RESULTS & PERFORMANCE .....	43

<b>11.</b>	<b>SPURIOUS EMISSIONS(RADIATION)</b> .....	<b>59</b>
11.1	TEST SETUP .....	59
11.2	LIMITS.....	60
11.3	TEST PROCEDURE .....	60
11.4	RESULTS & PERFORMANCE .....	62
<b>12.</b>	<b>AC POWER LINE CONDUCTED EMISSIONS</b> .....	<b>90</b>
12.1	TEST SETUP .....	90
12.2	LIMITS.....	90
12.3	TEST PROCEDURE .....	90
12.4	RESULTS & PERFORMANCE .....	91
<b>APPENDIX 1</b>	<b>PHOTOGRAPHS OF TEST SETUP</b> .....	<b>95</b>
<b>APPENDIX 2</b>	<b>PHOTOGRAPHS OF EUT</b> .....	<b>98</b>

# 1. GENERAL INFORMATION

## 1.1 EUT DESCRIPTION

Product Name:	GSM/GPRS Wireless Data Module
Model Name:	SIM800H
Hardware Version:	V1.02
Software Version:	SIM800 R13.08
RF Exposure Environment:	Uncontrolled
<b>Bluetooth</b>	
Frequency Range:	2400MHz~2483.5MHz
Type of Modulation:	GFSK(1 Mbps), $\pi$ /4-DQPSK(2 Mbps) 8-DPSK(3 Mbps)
Channel Separation:	1MHz
Channel Number:	79
Antenna Type:	External
Antenna Peak Gain:	2dBi

## 1.2 TEST MODE

Unilab has verified the construction and function in typical operation. All the test modes were carried out with the EUT in normal operation, which was shown in this test report and defined as:

Test Mode
Mode 1: GFSK Bluetooth CH0
Mode 2: GFSK Bluetooth CH39
Mode 3: GFSK Bluetooth CH78
Mode 4: 8-DPSK Bluetooth CH0
Mode 5: 8-DPSK Bluetooth CH39
Mode 6: 8-DPSK Bluetooth CH78

Note:

1. Regards to the frequency band operation: the lowest, middle and highest frequency of channel were selected to perform the test, then shown on this report.
2. For the ERP/EIRP and radiated emission test, every axis (X, Y, Z) was verified, and show the worst result on this report.

## **2. TEST METHODOLOGY**

The tests documented in this report were performed in accordance with ANSI C63.4: 2009 and FCC CFR 47 2.1046, 2.1047, 2.1049, 2.1051, 2.1053, 2.1055, 2.1057, 15.207, 15.209 and 15.247.

### **2.1 EUT CONFIGURATION**

The EUT configuration for testing is installed on RF field strength measurement to meet the Commissions requirement and operating in a manner that intends to maximize its emission characteristics in a continuous normal application

### **2.2 EUT EXERCISE**

The EUT was operated in the engineering mode to fix the TX frequency that was for the purpose of the measurements. According to its specifications, the EUT must comply with the requirements of the Section 15.207, 15.209 and 15.247 under the FCC Rules Part 15 Subpart C.

### **2.3 GENERAL TEST PROCEDURES**

#### **Conducted Emissions**

The EUT is placed on the turntable, which is 0.8 m above ground plane. According to the requirements in Section 13.1.4.1 of ANSI C63.4: 2009 Conducted emissions from the EUT measured in the frequency range between 0.15 MHz and 30MHz using CISPR Quasi-peak and average detector modes.

#### **Radiated Emissions**

The EUT is placed on a turn table, which is 0.8 m above ground plane. The turntable shall rotate 360 degrees to determine the position of maximum emission level. EUT is set 3m away from the receiving antenna, which varied from 1m to 4m to find out the highest emission. And also, each emission was to be maximized by changing the polarization of receiving antenna both horizontal and vertical. In order to find out the maximum emissions, exploratory radiated emission measurements were made according to the requirements in Section 13.1.4.1 of ANSI C63.4: 2009

## 2.4 FCC PART 15.205 RESTRICTED BANDS OF OPERATIONS

(a) Except as shown in paragraph (d) of this section, only spurious emissions are permitted in any of the frequency bands listed below:

MHz	MHz	MHz	GHz
0.090 - 0.110	16.42 - 16.423	399.9 - 410	4.5 - 5.15
<sup>1</sup> 0.495 - 0.505	16.69475 - 16.69525	608 - 614	5.35 - 5.46
2.1735 - 2.1905	16.80425 - 16.80475	960 - 1240	7.25 - 7.75
4.125 - 4.128	25.5 - 25.67	1300 - 1427	8.025 - 8.5
4.17725 - 4.17775	37.5 - 38.25	1435 - 1626.5	9.0 - 9.2
4.20725 - 4.20775	73 - 74.6	1645.5 - 1646.5	9.3 - 9.5
6.215 - 6.218	74.8 - 75.2	1660 - 1710	10.6 - 12.7
6.26775 - 6.26825	108 - 121.94	1718.8 - 1722.2	13.25 - 13.4
6.31175 - 6.31225	123 - 138	2200 - 2300	14.47 - 14.5
8.291 - 8.294	149.9 - 150.05	2310 - 2390	15.35 - 16.2
8.362 - 8.366	156.52475 - 156.52525	2483.5 - 2500	17.7 - 21.4
8.37625 - 8.38675	156.7 - 156.9	2655 - 2900	22.01 - 23.12
8.41425 - 8.41475	162.0125 - 167.17	3260 - 3267	23.6 - 24.0
12.29 - 12.293	167.72 - 173.2	3332 - 3339	31.2 - 31.8
12.51975 - 12.52025	240 - 285	3345.8 - 3358	36.43 - 36.5
12.57675 - 12.57725	322 - 335.4	3600 - 4400	( <sup>2</sup> )
13.36 - 13.41			

1 Until February 1, 1999, this restricted band shall be 0.490-0.510 MHz.

2 Above 38.6

(b) Except as provided in paragraphs (d) and (e), the field strength of emissions appearing within these frequency bands shall not exceed the limits shown in Section 15.209. At frequencies equal to or less than 1000 MHz, compliance with the limits in Section 15.209 shall be demonstrated using measurement instrumentation employing a CISPR quasi-peak detector. Above 1000 MHz, compliance with the emission limits in Section 15.209 shall be demonstrated based on the average value of the measured emissions. The provisions in Section 15.35 apply to these measurements.

## 2.5 DESCRIPTION OF TEST MODES

The EUT has been tested under operating condition.

After verification, all tests were carried out with the worst case test modes as shown below GFSK(1Mbps) and 8-DPSK(3 Mbps) Channel Low (2402MHz) 、Mid (2441MHz) and High (2480MHz), these were chosen for full testing.

### 3. TECHNICAL SUMMARY

#### 3.1 SUMMARY OF STANDARDS AND TEST RESULTS

The EUT have been tested according to the applicable standards as referenced below:

Test Item	FCC Rule	Result
Channel Separation	§15.247 (a)	P
Minimum Hopping Channel	§15.247 (a)	P
Occupied Bandwidth	§15.247 (a)	P
Dwell Time	§15.247 (a)	P
Peak Output Power (Conduction)	§15.247 (b)	P
Spurious Emissions (Conduction)	§15.247 (d)	P
Band edge measurement	§15.247 (d)	P
Spurious Emissions (Radiation)	§15.247 (d) §15.35 (b) §15.209 (a)	P
AC Power Line Conducted Emissions	§15.207 (a)	P

Note: P means pass, F means failure, N/A means not applicable

#### 3.2 TEST UNCERTAINTY

Where relevant, the following test uncertainty levels have been estimated for tests performed on the EUT as specified in CISPR 16-4-2. This uncertainty represents an expanded uncertainty expressed at approximately the 95% confidence level using a coverage factor of k=2.

Test item	Value (dB)
Conducted disturbance	3.4
Radiated disturbance	4.2

#### 3.3 TEST EQUIPMENT LIST

Equipment	Manufacturer	Model	Serial No.	Due Date
Receiver	Agilent	N9038A	MY51210142	2013/09/28
LISN	R&S	ENV216	100069	2014/06/23
3m Chamber & Accessory Equipment	ETS-LINDGREN	FACT-3	CT-0000336	2013/11/27
Microwave Preamplifier	EM Electronics	EM30180	3008A02425	2014/03/01
Power Splitter	Agilent	11667C/ 52401	MY53806148	2014/03/01
Cold-heat climate test chamber	Weiss-Voetsch Environmental Testing Instruments(Taica	C, 180, -40	546860026200 10	2013.12.4



	ng) Co., Ltd.			
DC Power Supply	Agilent	6612C	MY43002989	2014.01.16
Bilog Antenna	Schwarzbeck	VULB9160	9160-3316	2013.10.17
VHF-UHF-Biconical Antenna	Schwarzbeck	VUBA9117	9117-263	2013.10.17
Broad-Band Horn Antenna	Schwarzbeck	BBHA9120D	9120D-942	2013.10.17
Broad-Band Horn Antenna	Schwarzbeck	BBHA9120D	9120D-943	2013.10.17

The measuring equipment utilized to perform the tests documented in this report has been calibrated once a year or in accordance with the manufacturer's recommendations, and has been calibrated by accredited calibration laboratories.

### 3.4 TEST FACILITY

All test facilities used to collect the test data are located at No. 1350, Lianxi Rd. Pudong New District, Shanghai, China. The site and apparatus are constructed in conformance with the requirements of ANSI C63.4: 2009, CISPR 16-1-1 and other equivalent standards. The laboratory is compliance with the requirements of the ISO/IEC/E 17025.

### 3.5 TEST SETUP CONFIGURATION

The information contained within this report is intended to show verification of compliance of the EUT to the requirements of CFR 47 FCC Part 15.247. The test photographs attached in Appendix 1 for the actual connections between EUT and support equipment.

#### **Notes:**

1. All the equipment/cables were placed in the worst-case configuration to maximize the emission during the test.
2. Grounding was established in accordance with the manufacturer's requirements and conditions for the intended use.

## 4. CHANNEL SEPARATION

### 4.1 TEST SETUP

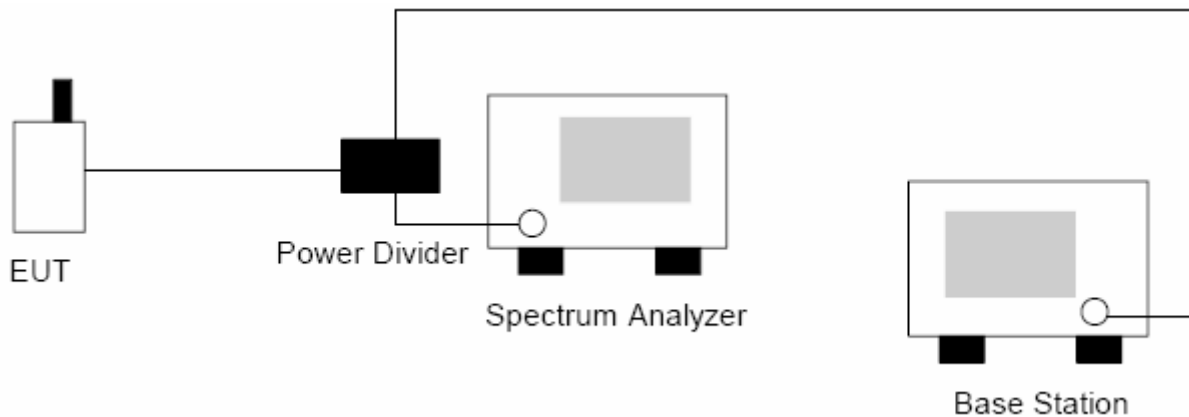

### 4.2 LIMITS

According to §15.247(a)(1), Frequency hopping systems shall have hopping channel carrier frequencies separated by a minimum of 25 kHz or the 20 dB bandwidth of the hopping channel, whichever is greater. Alternatively, frequency hopping systems operating in the 2400-2483.5 MHz band may have hopping channel carrier frequencies that are separated by 25 kHz or two-thirds of the 20 dB bandwidth of the hopping channel, whichever is greater, provided the systems operate with an output power no greater than 125 mW.

### 4.3 TEST PROCEDURE

The EUT have its hopping function enabled. Use the following spectrum analyzer settings:

Span = wide enough to capture the peaks of two adjacent channels

Resolution (or IF) Bandwidth (RBW)  $\geq 1\%$  of the span

Video (or Average) Bandwidth (VBW)  $\geq$  RBW

Sweep = auto

Detector function = peak

Trace = max hold

Allow the trace to stabilize. Use the marker-delta function to determine the separation between the peaks of the adjacent channels.



## 5. MINIMUM HOPPING CHANNELS

### 5.1 TEST SETUP

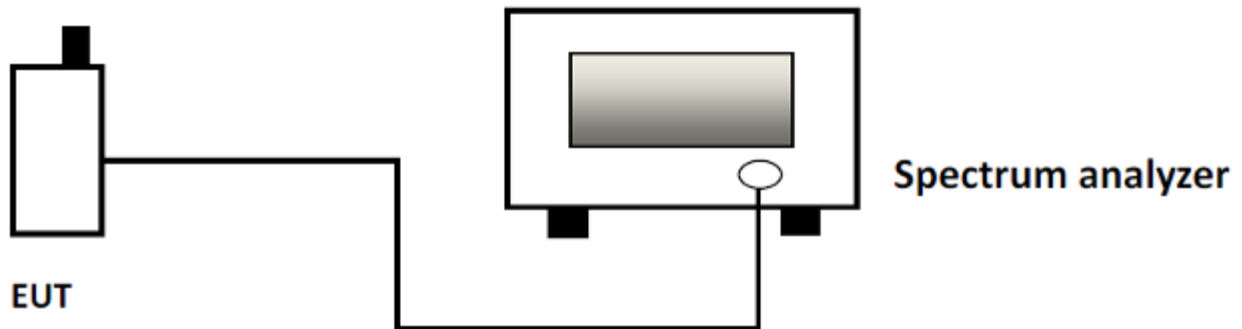

### 5.2 LIMITS

According to §15.247(a)(1)(iii), Frequency hopping systems operating in the 2400MHz-2483.5 MHz bands shall use at least 15 hopping frequencies.

### 5.3 TEST PROCEDURE

The EUT have its hopping function enabled.

Use the following spectrum analyzer settings:

Span = the frequency band of operation

RBW  $\geq$  1% of the span

VBW  $\geq$  RBW

Sweep = auto

Detector function = peak

Trace = max hold

Allow the trace to stabilize. It may prove necessary to break the span up to sections, in order to clearly show all of the hopping frequencies.

### 5.4 TEST RESULT

GFSK Hopping Channel: 79 channels

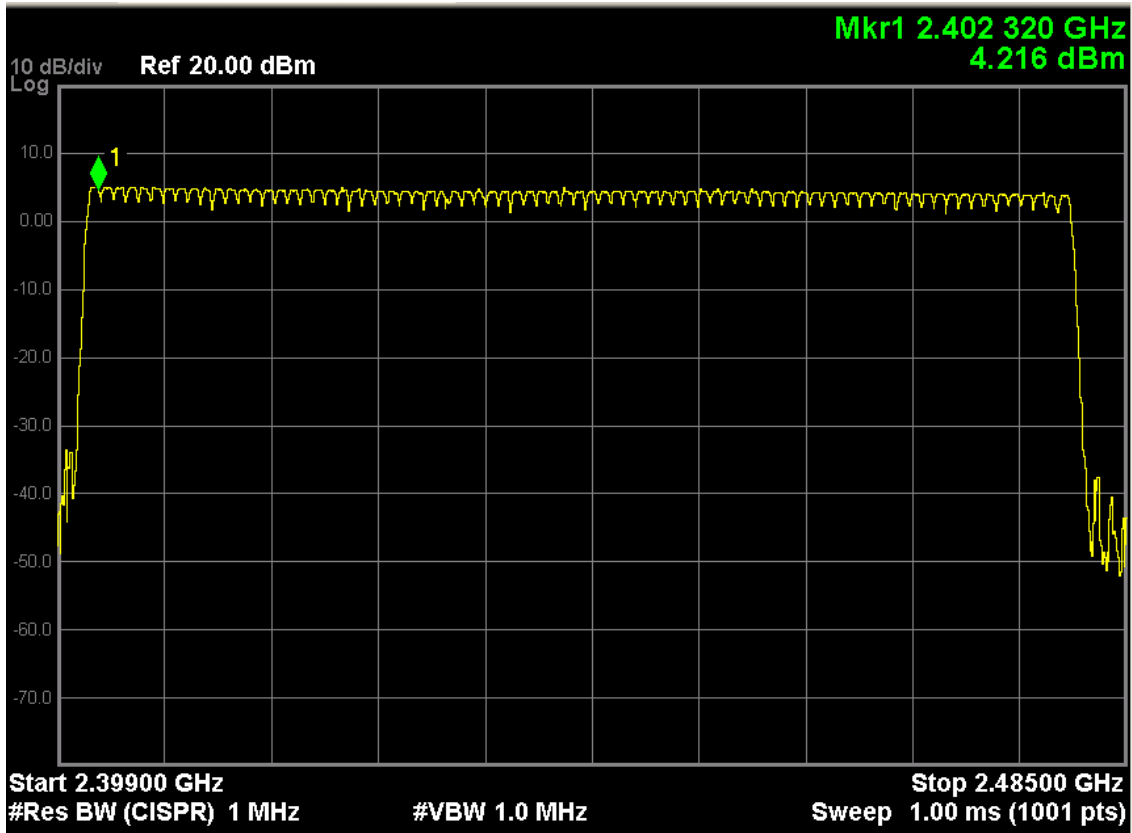

8-DPSK Hopping Channel: 79 channels

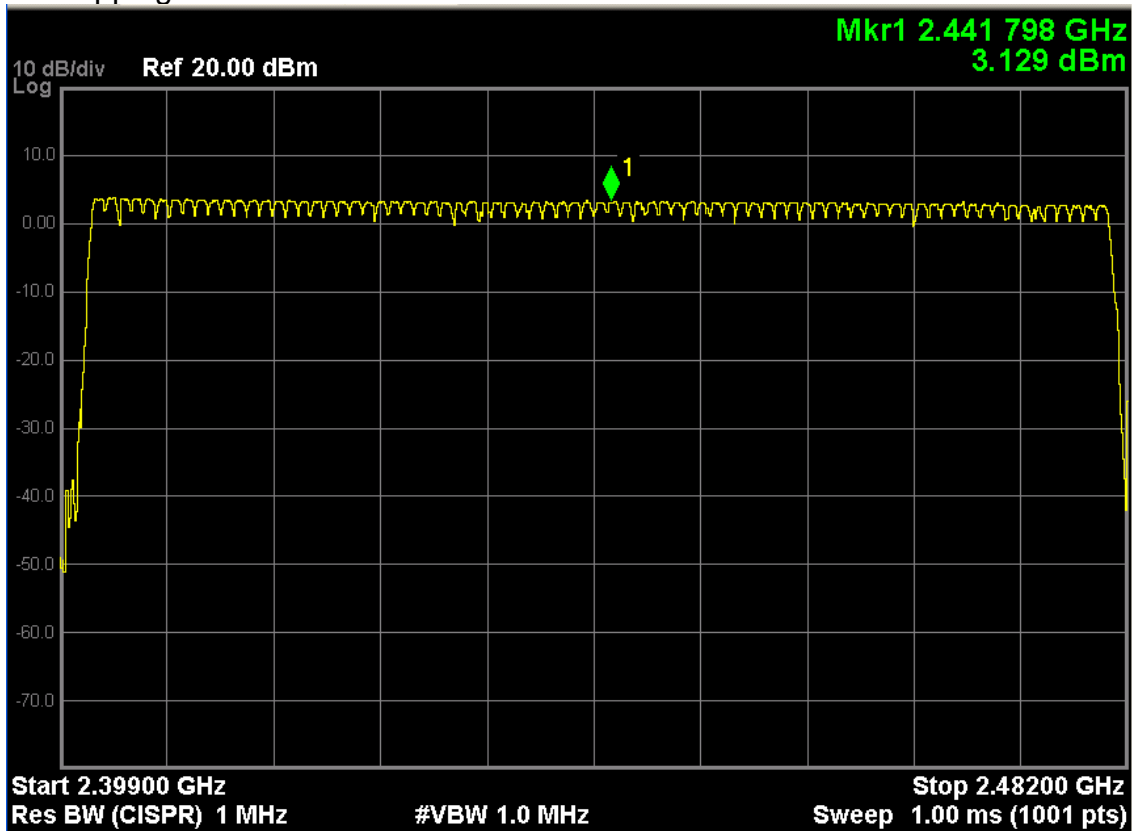

## 6. OCCUPIED BANDWIDTH

### 6.1 TEST SETUP

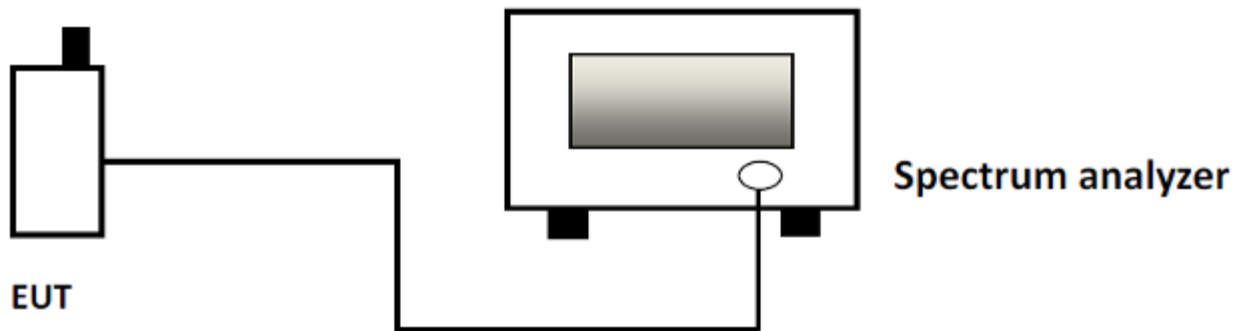

### 6.2 LIMITS

According to §15.247(a)(1), Frequency hopping systems shall have hopping channel carrier frequencies separated by a minimum of 25 kHz or the 20 dB bandwidth of the hopping channel, whichever is greater. Alternatively, frequency hopping systems operating in the 2400-2483.5 MHz band may have hopping channel carrier frequencies that are separated by 25 kHz or two-thirds of the 20 dB bandwidth of the hopping channel, whichever is greater, provided the systems operate with an output power no greater than 125 mW.

### 6.3 TEST PROCEDURE

Use the following spectrum analyzer settings:

Span = approximately 2 to 3 times the 6 dB or 20 dB bandwidth, centered on a channel

RBW  $\geq$  1% of the 6 dB or 20 dB bandwidth

VBW  $\geq$  RBW

Sweep = auto

Detector function = peak

Trace = max hold

The EUT should be transmitting at its maximum data rate. Allow the trace to stabilize. Use the marker-to-peak function to set the marker to the peak of the emission. Use the marker-delta function to measure 6 dB or 20 dB down one side of the emission. Reset the marker-delta function, and move the marker to the other side of the emission, until it is (as close as possible to) even with the reference marker level. The marker-delta reading at this point is the 6 dB or 20 dB bandwidth of the emission. If this value varies with different modes of operation (e.g., data rate, modulation format, etc.), repeat this test for each variation.

**TEST RESULTS**

Channel	20dB bandwidth (MHz)	99% bandwidth (MHz)
<b>GFSK</b>		
BT CH0	0.6181	0.80695
BT CH39	0.6661	0.80928
BT CH79	0.6649	0.81044
<b>8-DPSK</b>		
BT CH0	1.121	1.0825
BT CH39	1.122	1.0848
BT CH79	1.119	1.0817

**GFSK Bluetooth Channel 0**

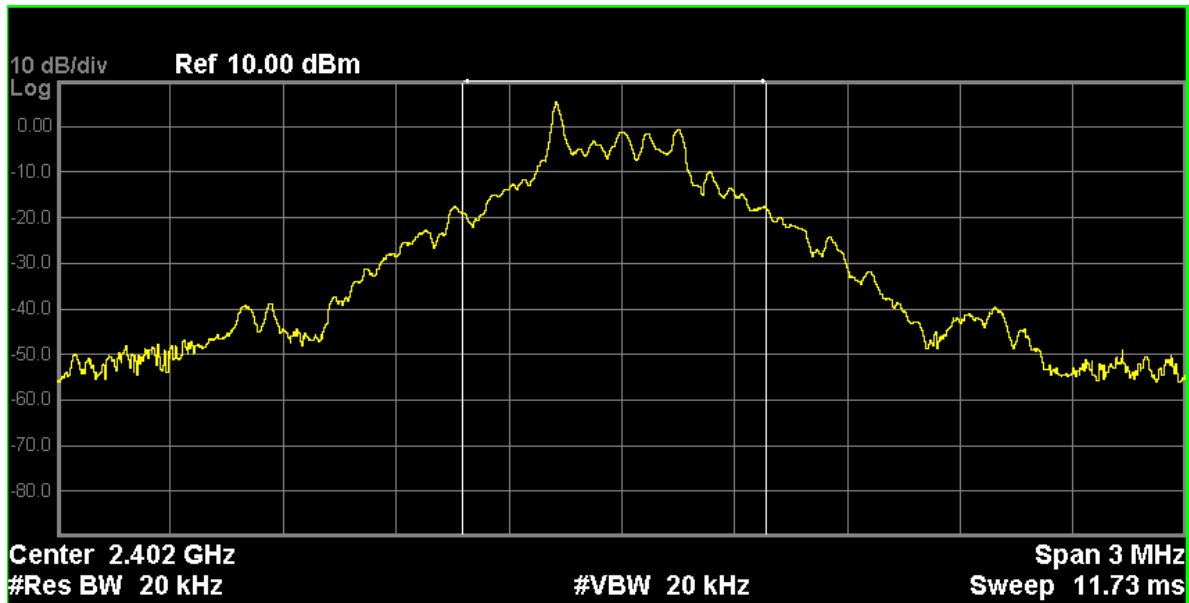

<b>Occupied Bandwidth</b>	<b>Total Power</b>	<b>10.4 dBm</b>
<b>806.95 kHz</b>		
<b>Transmit Freq Error</b>	<b>-19.345 kHz</b>	<b>OBW Power</b>
		<b>99.00 %</b>
<b>x dB Bandwidth</b>	<b>618.1 kHz</b>	<b>x dB</b>
		<b>-20.00 dB</b>

**GFSK Bluetooth Channel 39**

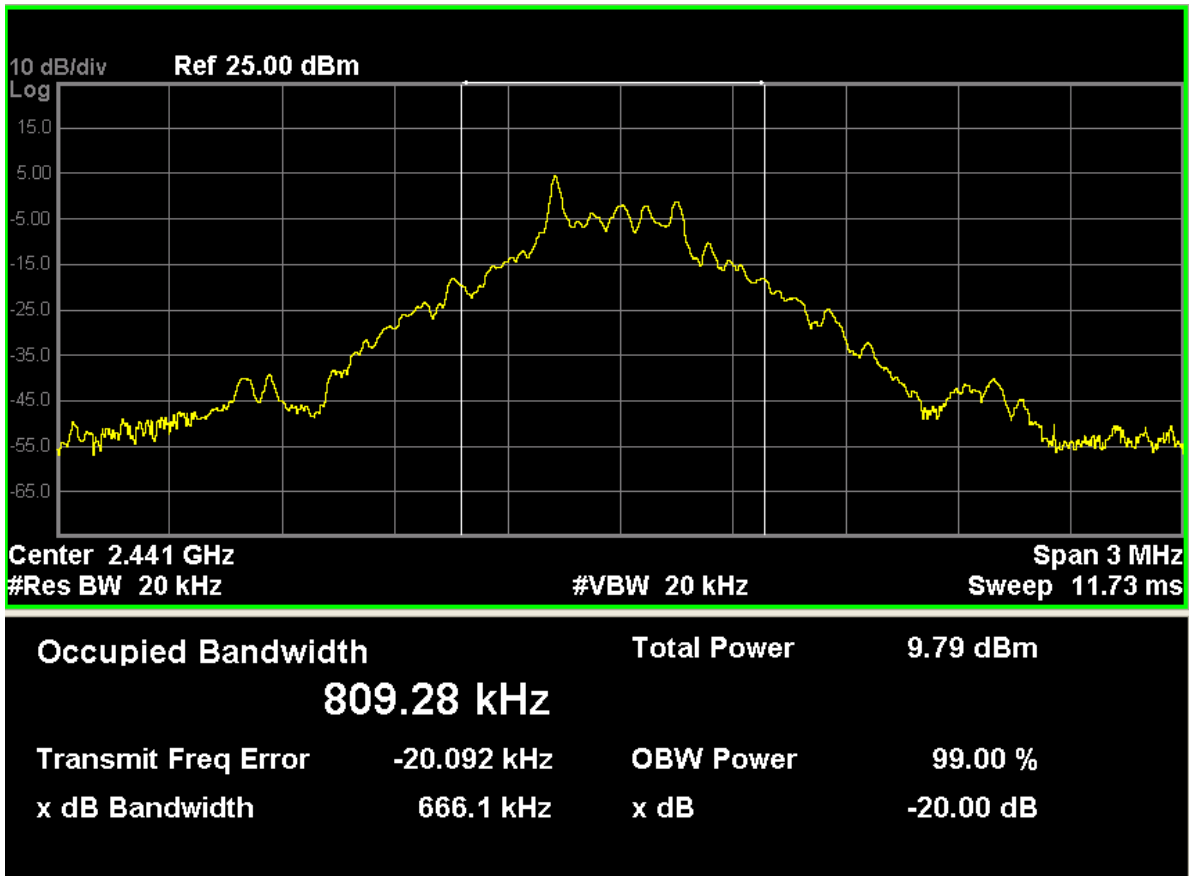

**GFSK Bluetooth Channel 78**





**8-DPSK Bluetooth Channel 0**



**8-DPSK Bluetooth Channel 39**

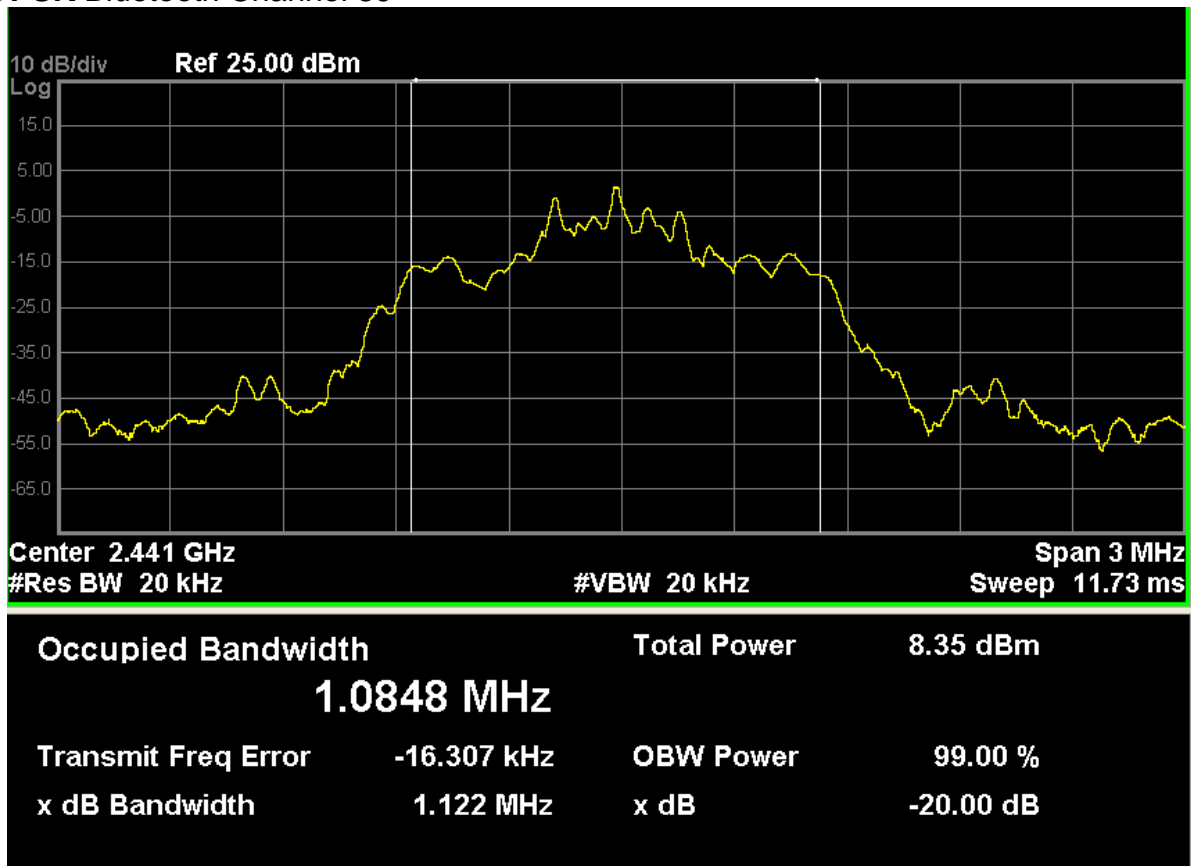

### 8-DPSK Bluetooth Channel 78

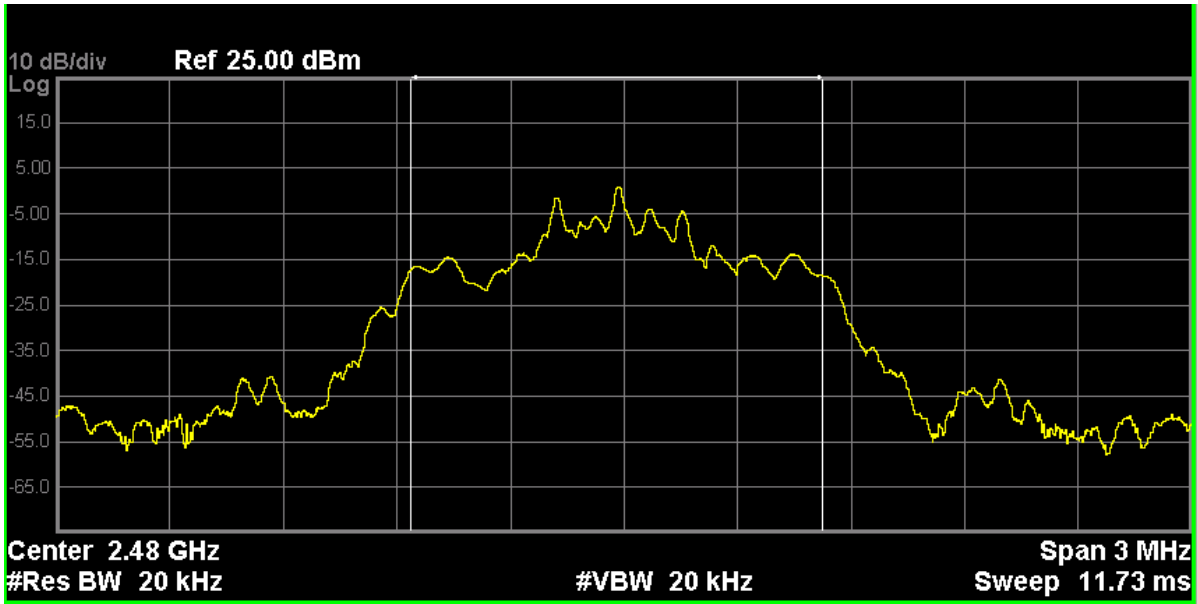

Occupied Bandwidth	Total Power	7.70 dBm	
<b>1.0817 MHz</b>			
Transmit Freq Error	-16.841 kHz	OBW Power	99.00 %
x dB Bandwidth	1.119 MHz	x dB	-20.00 dB

## 7. DWELL TIME

### 7.1 TEST SETUP

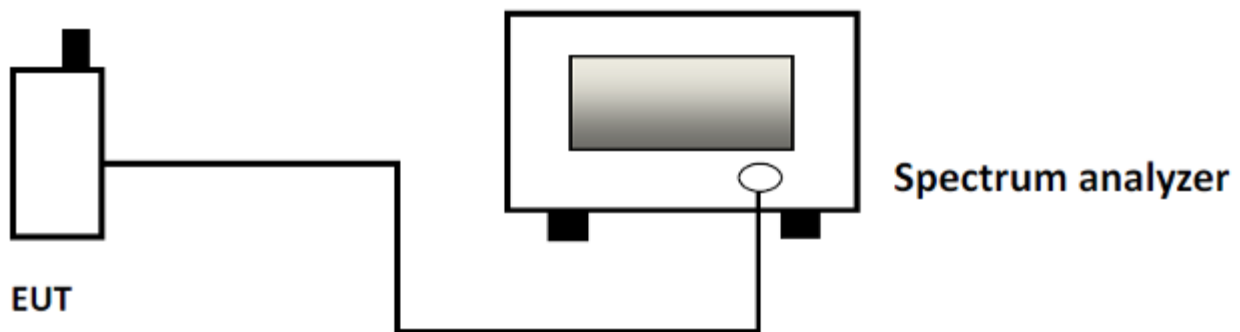

### 7.2 LIMITS

According to §15.247(a)(1)(iii), Frequency hopping systems operating in the 2400MHz-2483.5 MHz bands. The average time of occupancy on any channels shall not greater than 0.4 seconds within a period 0.4 seconds multiplied by the number of hopping channels employed.

### 7.3 TEST PROCEDURE

The EUT must have its hopping function enabled.

Use the following spectrum analyzer settings:

Span = zero span, centered on a hopping channel

$RBW \leq \text{Channel Separation}$

$RBW \leq VBW$

Sweep = as necessary to capture the entire dwell time per hopping channel

Detector function = peak

Trace = max hold

If possible, use the marker-delta function to determine the dwell time. If this value varies with different modes of operation (e.g., data rate, modulation format, etc.), repeat this test for each variation.









## 8. PEAK OUTPUT POWER (CONDUCTION)

### 8.1 TEST SETUP

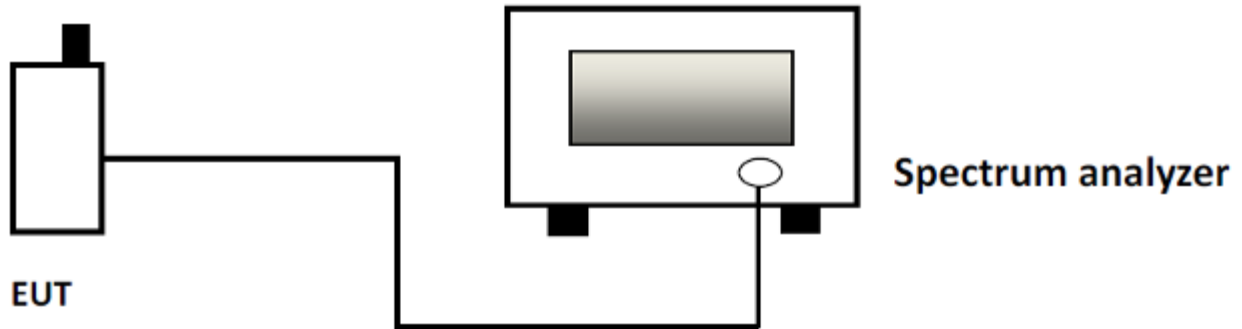

### 8.2 LIMITS

The maximum peak output power of the intentional radiator shall not exceed the following:

1. According to §15.247(a)(1), Frequency hopping systems shall have hopping channel carrier frequencies separated by a minimum of 25 kHz or the 20 dB bandwidth of the hopping channel, whichever is greater. Alternatively, frequency hopping systems operating in the 2400-2483.5 MHz band may have hopping channel carrier frequencies that are separated by 25 kHz or two-thirds of the 20 dB bandwidth of the hopping channel, whichever is greater, provided the systems operate with an output power no greater than 125 mW.
2. According to §15.247(b)(3), for systems using digital modulation in the bands of 902-928 MHz, 2400-2483.5 MHz, and 5725-5850 MHz: 1 Watt.
3. According to §15.247(b)(4), the conducted output power limit specified in paragraph (b) of this section is based on the use of antennas with directional gains that do not exceed 6 dBi. Except as shown in paragraph (c) of this section, if transmitting antennas of directional gain greater than 6 dBi are used, the conducted output power from the intentional radiator shall be reduced below the stated values in paragraphs (b)(1), (b)(2), and (b)(3) of this section, as appropriate, by the amount in dB that the directional gain of the antenna exceeds 6 dBi.

### 8.3 TEST PROCEDURE

After a radio link has been established between EUT and Base station, the output power of the cell signal of the testing equipment will be decreased until the output power of the EUT reach a maximum value. Then the test data can be read at the tester screen. The loss between RF output port of the EUT and the input port of the tester will be taken into consideration.

The measurement will be conducted at three channels:

Bluetooth: Low(0), middle(39) and High (78),

Set the spectrum analyzer as RBW = 3MHz, VBW =3MHz, Span = 10MHz, Sweep=auto  
Detector = Peak, Trace mode = max hold



### 8.4 RESULTS & PERFORMANCE

GFSK				
Channel	Peak power (dBm)	Peak power (mW)	Limit (mW)	Result
0 (2402MHz)	5.935	3.92	125	Pass
39 (2441MHz)	5.887	3.88		Pass
78 (2480MHz)	5.628	3.65		Pass
8-DPSK				
Channel	Peak power (dBm)	Peak power (mW)	Limit (dBm)	Result
0 (2402MHz)	5.929	3.92	125	Pass
39 (2441MHz)	4.639	2.91		Pass
78 (2480MHz)	4.399	2.75		Pass

Bluetooth GFSK Channel 0

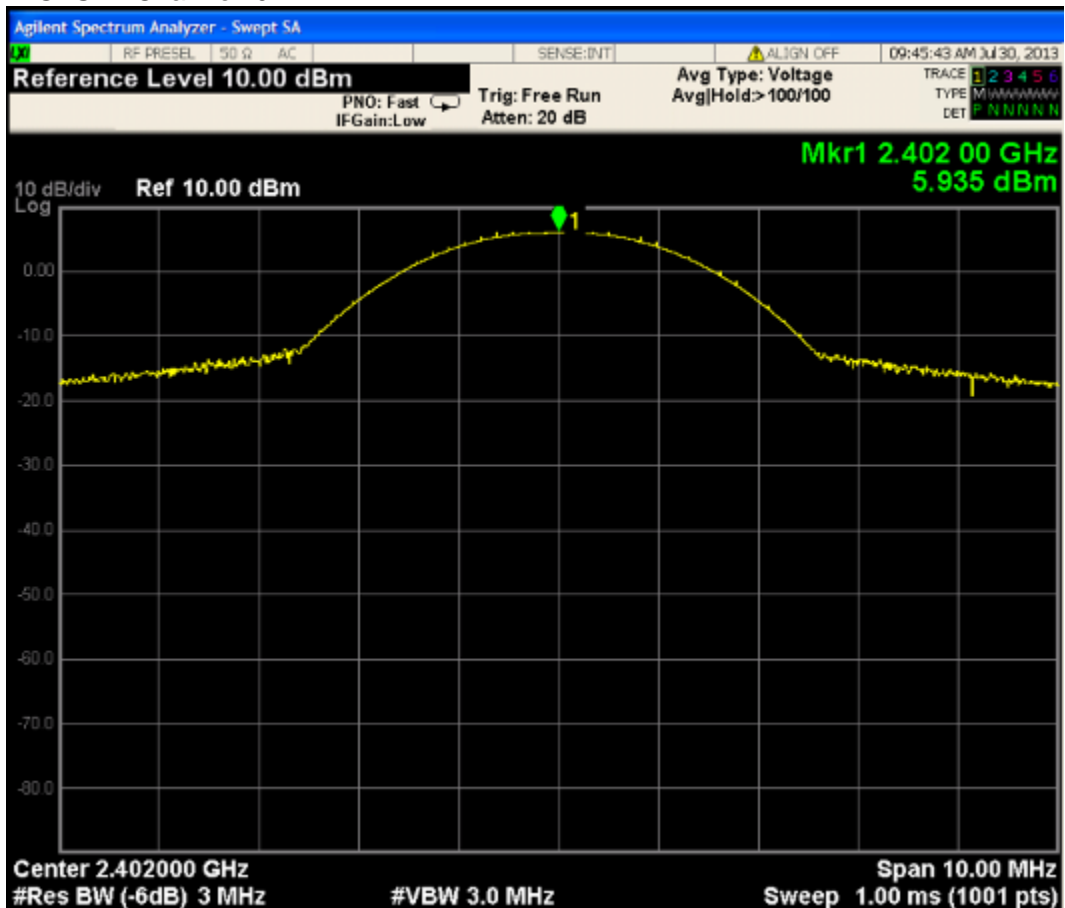

Bluetooth GFSK Channel 39

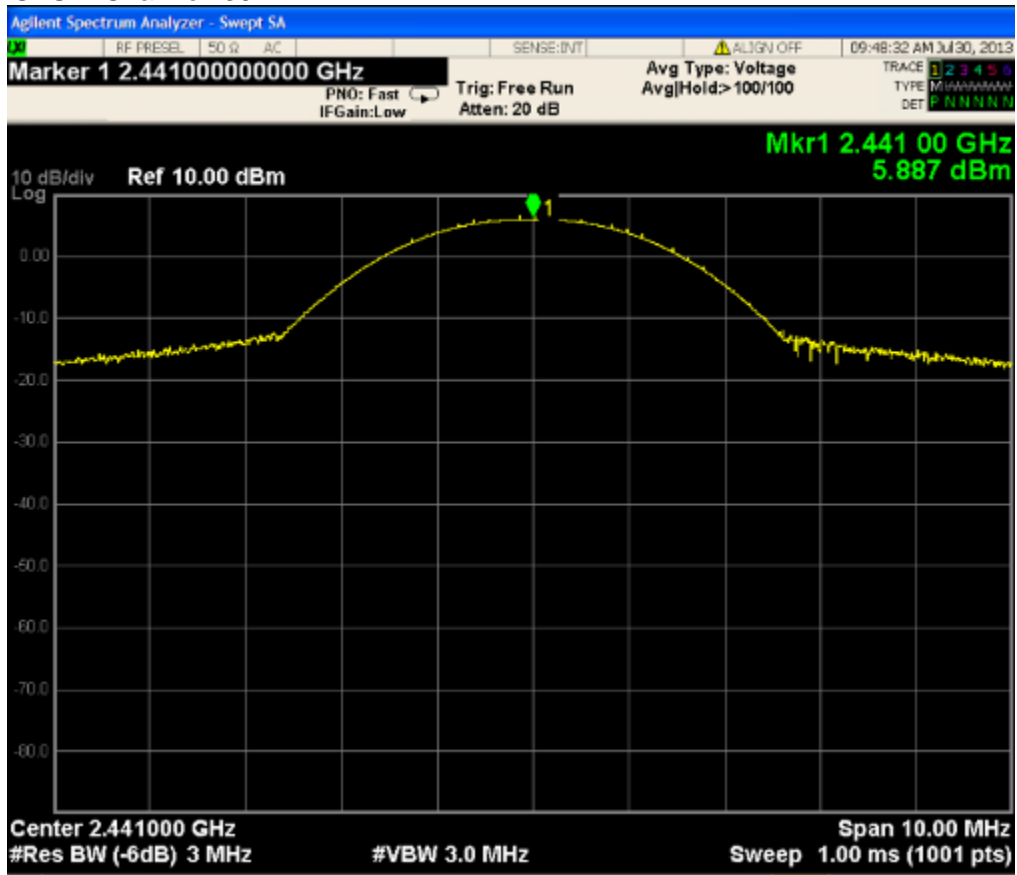

Bluetooth GFSK Channel 78

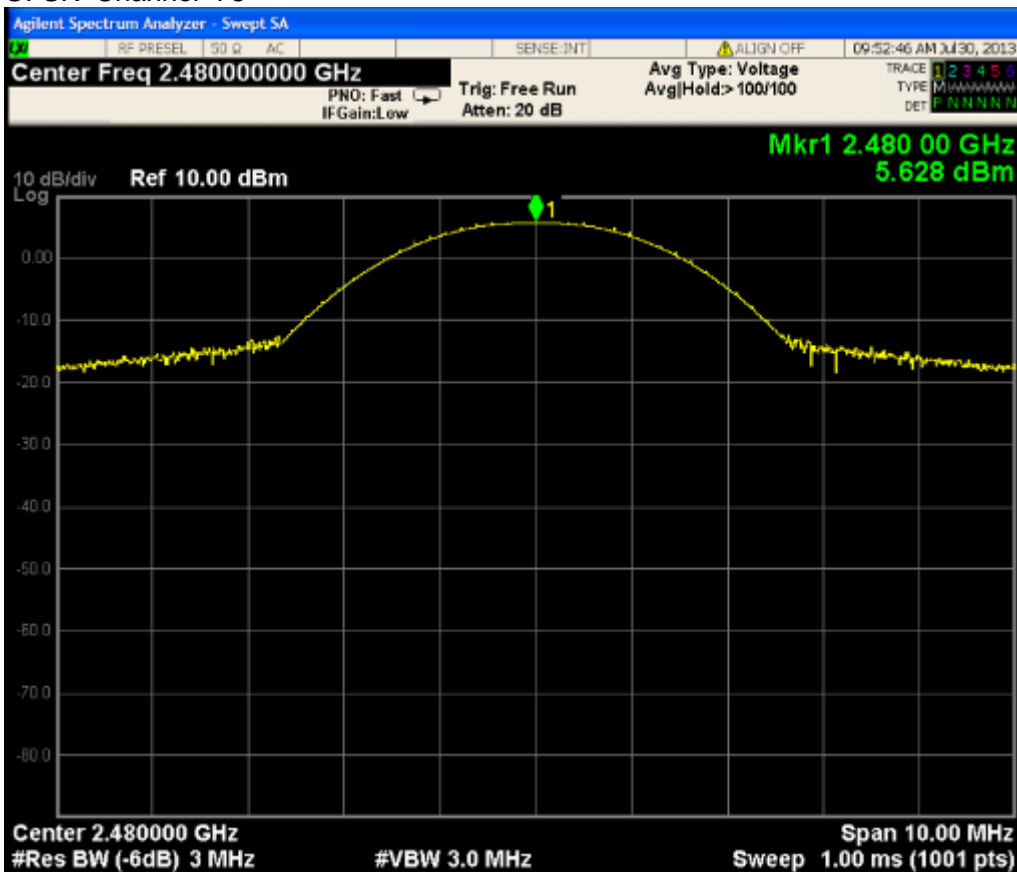

Bluetooth 8-DPSK Channel 0

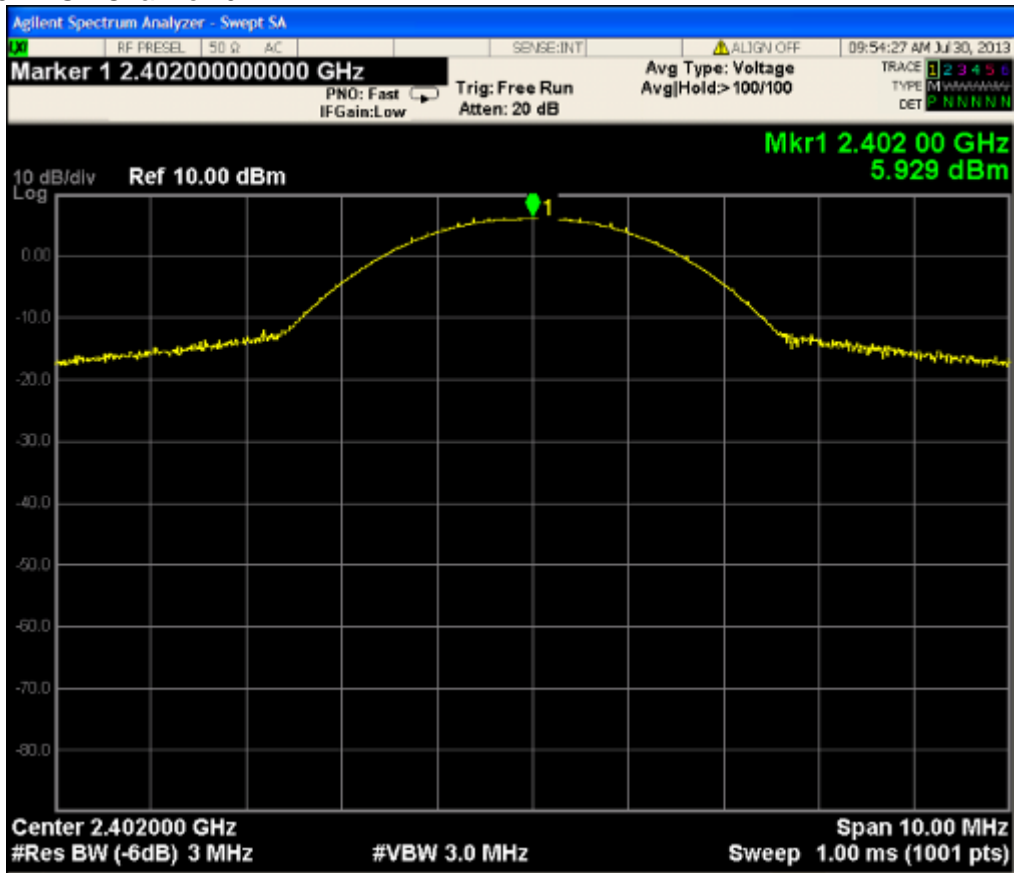

Bluetooth 8-DPSK Channel 39

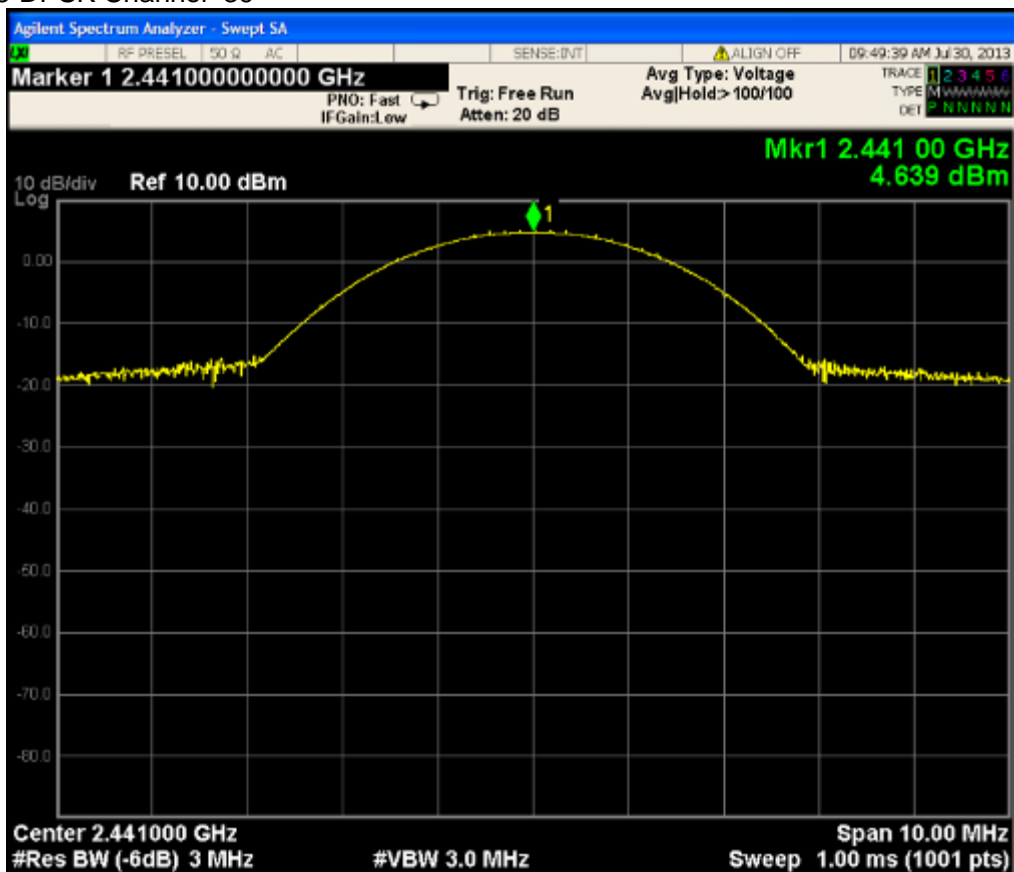

Bluetooth 8-DPSK Channel 78

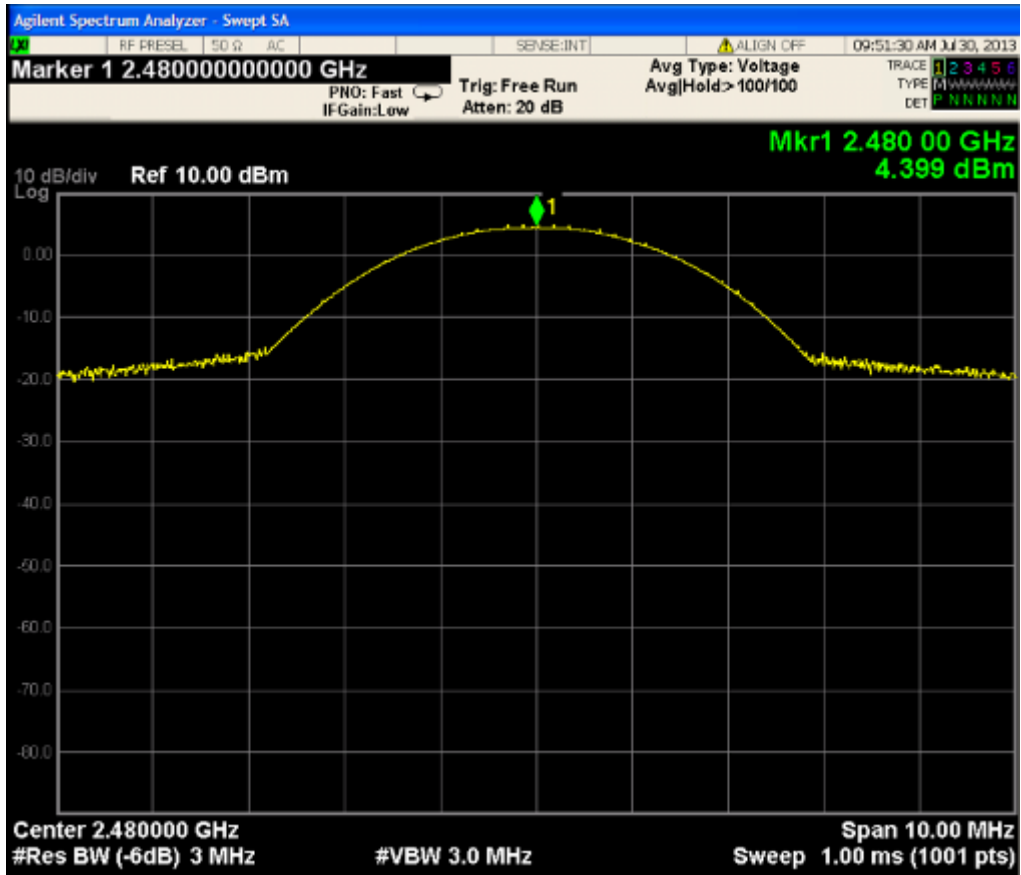

## 9. SPURIOUS EMISSIONS (CONDUCTION)

### 9.1 TEST SETUP

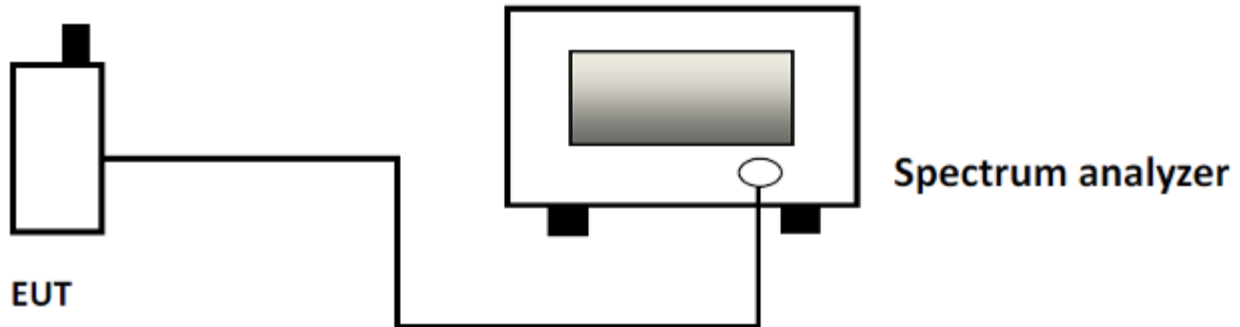

### 9.2 LIMITS

In any 100 kHz bandwidth outside the frequency band in which the spread spectrum or digitally modulated intentional radiator is operating, the radio frequency power that is produced by the intentional radiator shall be at least 20 dB below that in the 100 kHz bandwidth within the band that contains the highest level of the desired power, based on either an RF conducted or a radiated measurement. Attenuation below the general limits specified in Section 15.209(a) is not required. In addition, radiated emissions which fall in the restricted bands, as defined in Section 15.205(a), must also comply with the radiated emission limits specified in Section 15.209(a) (see Section 15.205(c)).

### 9.3 TEST PROCEDURE

The EUT was connected to Spectrum Analyzer and Base Station via power divider. Use the following spectrum analyzer settings:

Span = wide enough to capture the peak level of the in-band emission and all spurious emissions (e.g., harmonics) from the lowest frequency generated in the EUT up through the 10th harmonic. Typically, several plots are required to cover this entire span.

RBW = 100 kHz; VBW  $\geq$  RBW; Sweep = auto; Detector function = peak; Trace = max hold  
Allow the trace to stabilize. Set the marker on the peak of any spurious emission recorded. The level displayed must comply with the limit specified in this Section.





























## 10. BAND EDGE MEASUREMENT

### 10.1 TEST SETUP

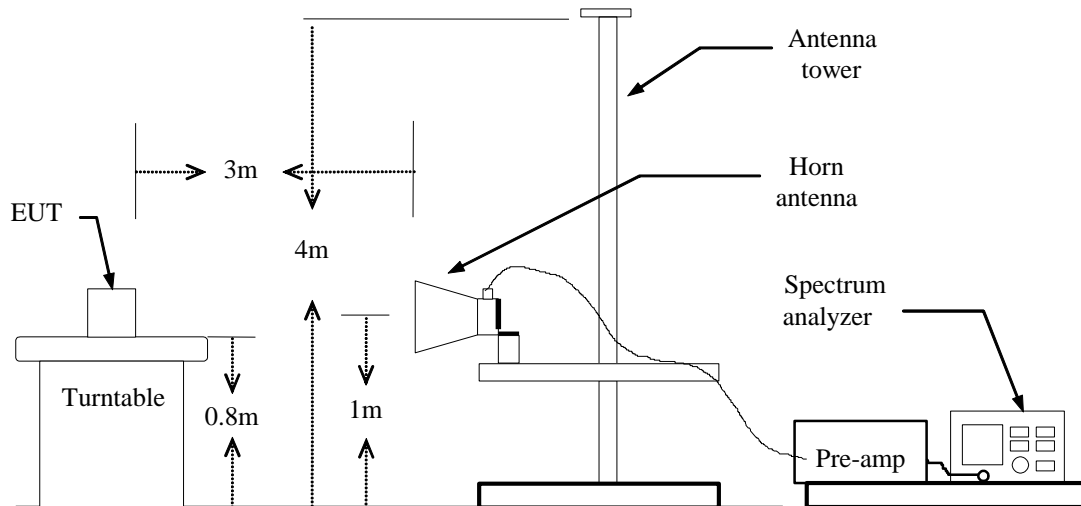

### 10.2 LIMITS

According to §15.247(c), in any 100 kHz bandwidth outside the frequency bands in which the spread spectrum intentional radiator is operating, the radio frequency power that is produced by the intentional radiator shall be at least 20dB below that in the 100kHz bandwidth within the band that contains the highest level of the desired power. In addition, radiated emissions which fall in the restricted bands, as defined in §15.205(a), must also comply with the radiated emission limits specified in §15.209(a).

### 10.3 TEST PROCEDURE

The EUT is placed on a turntable, which is 0.8m above the ground plane.

The turntable shall be rotated for 360 degrees to determine the position of maximum emission level.

EUT is set 3m away from the receiving antenna, which is varied from 1m to 4m to find out the highest emission.

Set the spectrum analyzer in the following setting in order to capture the lower and upper band-edges of the emission:

PEAK: RBW=VBW=1MHz / Sweep=AUTO

AVERAGE: RBW=1MHz / VBW=10Hz / Sweep=AUTO

Repeat the procedures until all the PEAK and AVERAGE versus POLARIZATION are measured.

### 10.4 RESULTS & PERFORMANCE

#### BT GFSK (Low Channel)

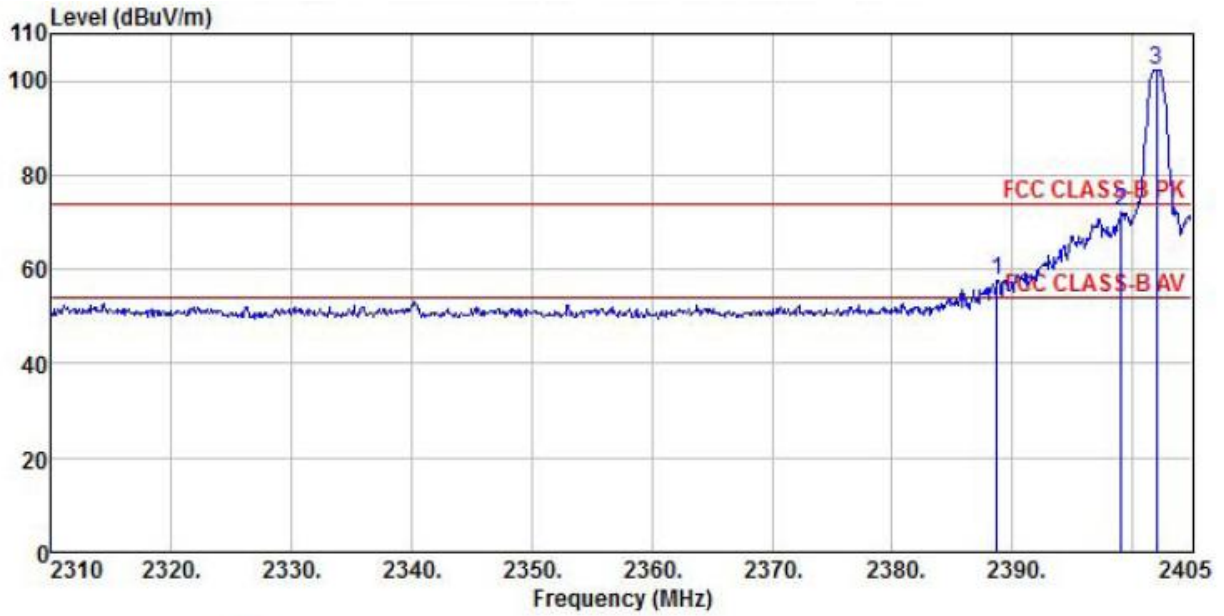

Site : chamber  
 Condition : FCC CLASS-B PK 3m BBHA9120D(RSE-V) VERTICAL  
 EUT : GSM/GPRS Wireless Data Module  
 Model Name : SIM800H  
 Temp/Humi : 24°C / 49%  
 Power Rating: AC 120V/60Hz  
 Mode : GFSK Channel 0  
 Memo :

	Freq	ReadAntenna Level	Cable Factor	Preamp Loss	Factor	Limit Level	Over Line	Remark
	MHz	dBuV	dB/m	dB	dB	dBuV/m	dBuV/m	dB
1	2388.76	51.12	37.92	7.13	38.34	57.83	74.00	-16.17 Peak
2	2399.11	65.63	37.92	7.13	38.34	72.34	74.00	-1.66 Peak
3 pp	2402.06	95.77	37.92	7.13	38.34	102.48	74.00	28.48 Peak

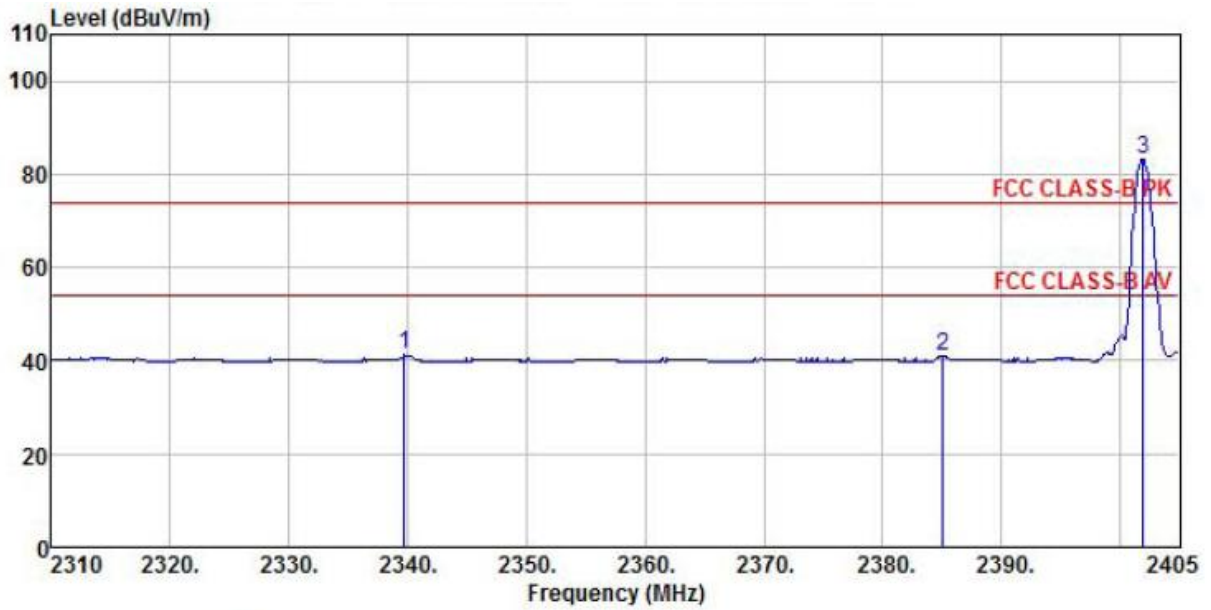

Site : chamber  
 Condition : FCC CLASS-B PK 3m BBHA9120D(RSE-V) VERTICAL  
 EUT : GSM/GPRS Wireless Data Module  
 Model Name : SIM800H  
 Temp/Humi : 24°C / 49%  
 Power Rating: AC 120V/60Hz  
 Mode : GFSK Channel 0  
 Memo :

	Freq	ReadAntenna Level	Cable Loss	Preamp Factor	Level	Limit	Over	Remark
	MHz	dBuV	dB/m	dB	dBuV/m	dBuV/m	dB	
1	2339.74	34.41	37.99	7.22	38.36	41.26	54.00	-12.74 Average
2	2385.05	34.35	37.95	7.16	38.35	41.11	54.00	-12.89 Average
3 pp	2401.96	76.69	37.92	7.13	38.34	83.40	54.00	29.40 Average

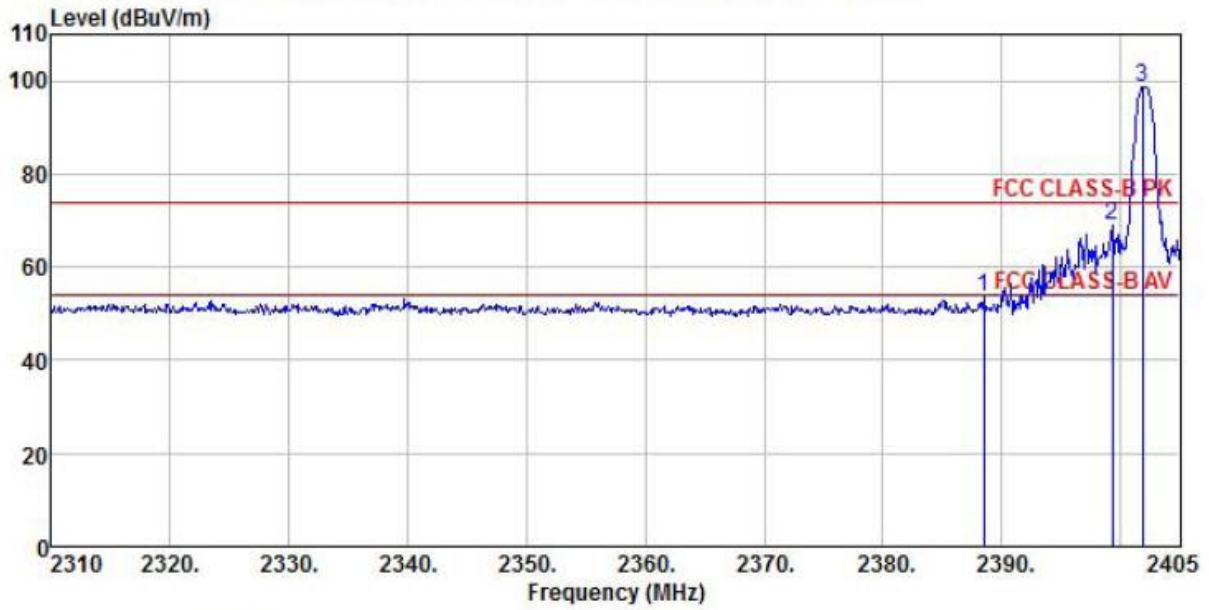

Site : chamber  
 Condition : FCC CLASS-B PK 3m BBHA9120D(RSE-H) HORIZONTAL  
 EUT : GSM/GPRS Wireless Data Module  
 Model Name : SIM800H  
 Temp/Humi : 24°C / 49%  
 Power Rating: AC 120V/60Hz  
 Mode : GFSK Channel 0  
 Memo :

	ReadAntenna	Cable	Preamp	Limit	Over				
Freq	Level	Loss	Factor	Line	Limit	Remark			
MHz	dBuV	dB/m	dB	dB	dBuV/m	dB			
1	2388.47	46.89	37.92	7.13	38.34	53.60	74.00	-20.40	Peak
2	2399.30	62.25	37.92	7.13	38.34	68.96	74.00	-5.04	Peak
3 pp	2401.87	92.01	37.92	7.13	38.34	98.72	74.00	24.72	Peak

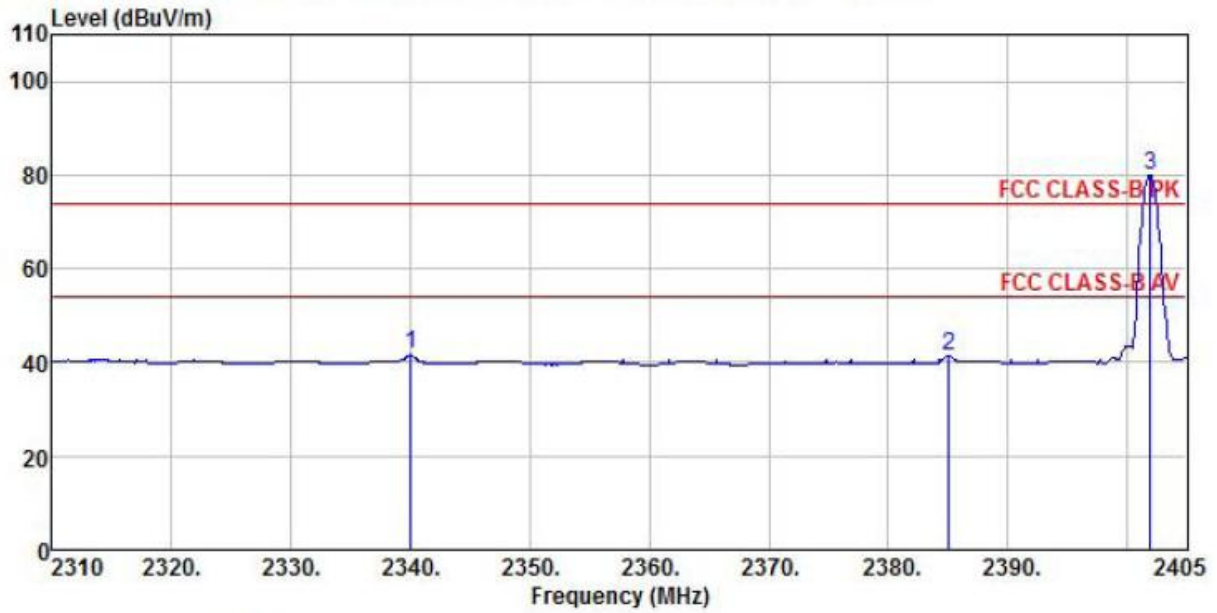

Site : chamber  
 Condition : FCC CLASS-B PK 3m BBHA9120D(RSE-H) HORIZONTAL  
 EUT : GSM/GPRS Wireless Data Module  
 Model Name : SIM800H  
 Temp/Humi : 24°C / 49%  
 Power Rating: AC 120V/60Hz  
 Mode : GFSK Channel 0  
 Memo :

	ReadAntenna	Cable	Preamp	Limit	Over			
Freq	Level	Loss	Factor	Line	Limit	Remark		
MHz	dBuV	dB/m	dB	dB	dBuV/m	dBuV/m	dB	
1	2340.02	35.15	37.99	7.22	38.36	42.00	54.00	-12.00 Average
2	2385.05	34.84	37.95	7.16	38.35	41.60	54.00	-12.40 Average
3 pp	2401.96	73.43	37.92	7.13	38.34	80.14	54.00	26.14 Average

### BT GFSK (High Channel)

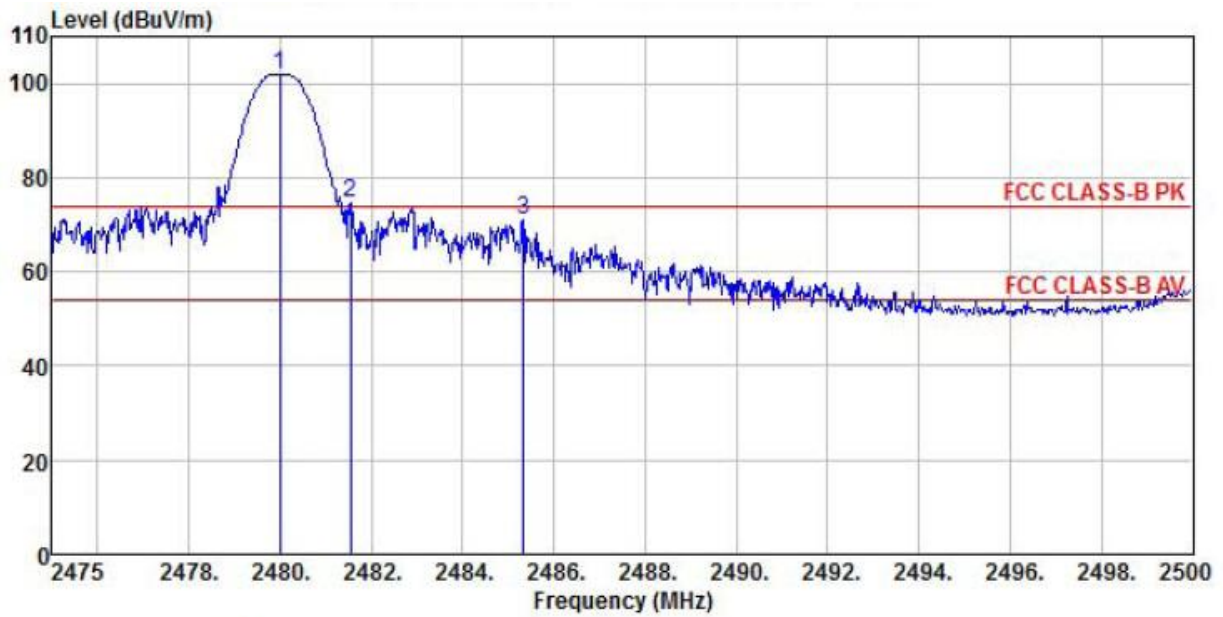

Site : chamber  
 Condition : FCC CLASS-B PK 3m BBHA9120D(RSE-V) VERTICAL  
 EUT : GSM/GPRS Wireless Data Module  
 Model Name : SIM800H  
 Temp/Humi : 24°C / 49%  
 Power Rating: AC 120V/60Hz  
 Mode : GFSK Channel 78  
 Memo :

	ReadAntenna	Cable	Preamp	Limit	Over			
Freq	Level	Factor	Loss	Factor	Level	Line	Limit	Remark
MHz	dBuV	dB/m	dB	dB	dBuV/m	dBuV/m	dB	
1 pp	2480.00	94.60	38.38	7.41	38.31	102.08	74.00	28.08 Peak
2 *	2481.55	67.15	38.38	7.41	38.31	74.63	74.00	0.63 Peak
3	2485.33	63.44	38.38	7.41	38.31	70.92	74.00	-3.08 Peak

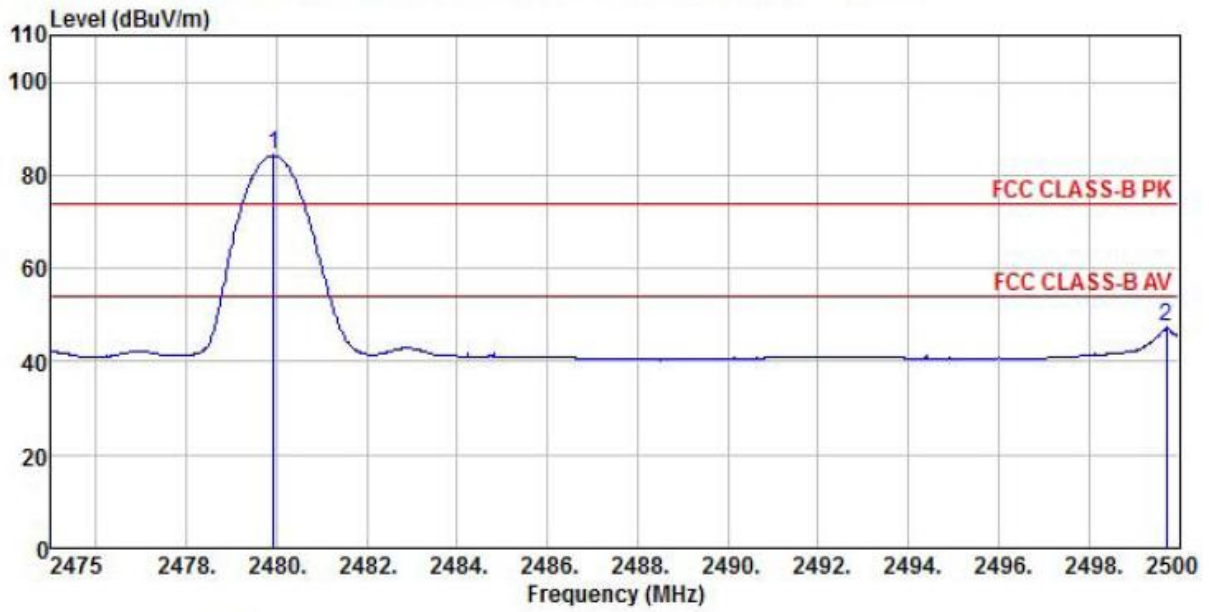

Site : chamber  
 Condition : FCC CLASS-B PK 3m BBHA9120D(RSE-V) VERTICAL  
 EUT : GSM/GPRS Wireless Data Module  
 Model Name : SIM800H  
 Temp/Humi : 24°C / 49%  
 Power Rating: AC 120V/60Hz  
 Mode : GFSK Channel 78  
 Memo :

	Freq	ReadAntenna Level	Cable Loss	Preamp Factor	Level	Limit Line	Over Limit	Remark
	MHz	dBuV	dB/m	dB	dBuV/m	dBuV/m	dB	
1 pp	2479.93	76.76	38.38	7.41	38.31	84.24	54.00	30.24 Average
2	2499.73	39.81	38.36	7.43	38.30	47.30	54.00	-6.70 Average



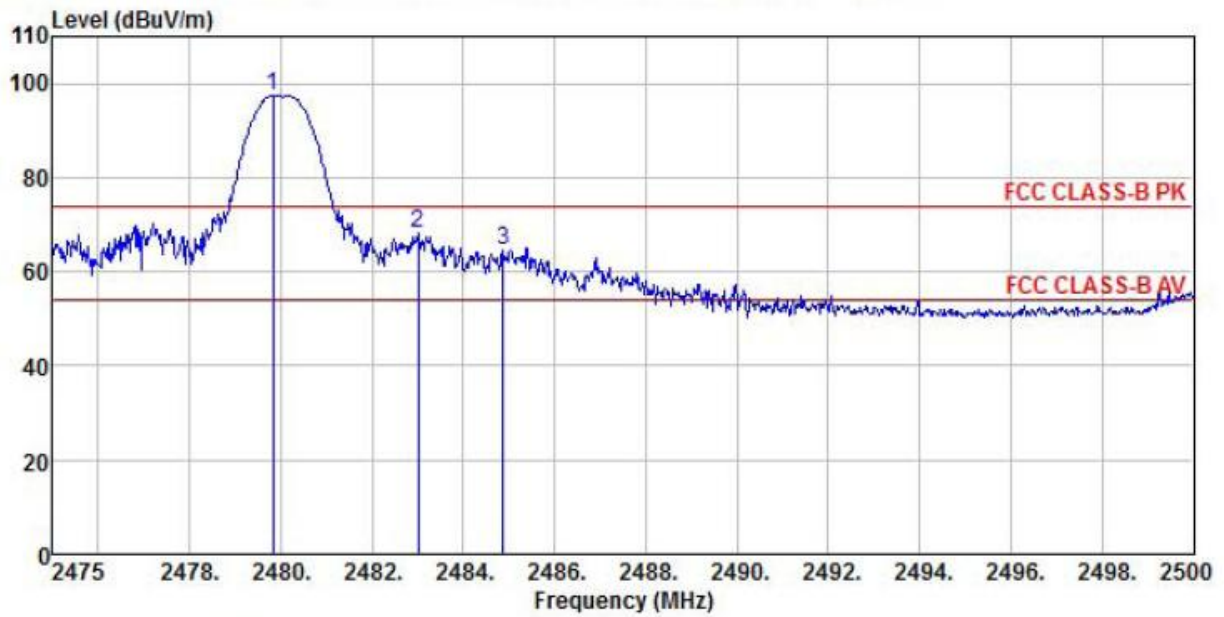

Site : chamber  
 Condition : FCC CLASS-B PK 3m BBHA9120D(RSE-H) HORIZONTAL  
 EUT : GSM/GPRS Wireless Data Module  
 Model Name : SIM800H  
 Temp/Humi : 24°C / 49%  
 Power Rating: AC 120V/60Hz  
 Mode : GFSK Channel 78  
 Memo :

	ReadAntenna	Cable	Preamp	Limit	Over			
Freq	Level	Factor	Loss	Factor	Level	Line	Limit	Remark
MHz	dBuV	dB/m	dB	dB	dBuV/m	dBuV/m	dB	
1 pp 2479.83	90.06	38.38	7.41	38.31	97.54	74.00	23.54	Peak
2 2483.00	60.76	38.38	7.41	38.31	68.24	74.00	-5.76	Peak
3 2484.88	57.21	38.38	7.41	38.31	64.69	74.00	-9.31	Peak

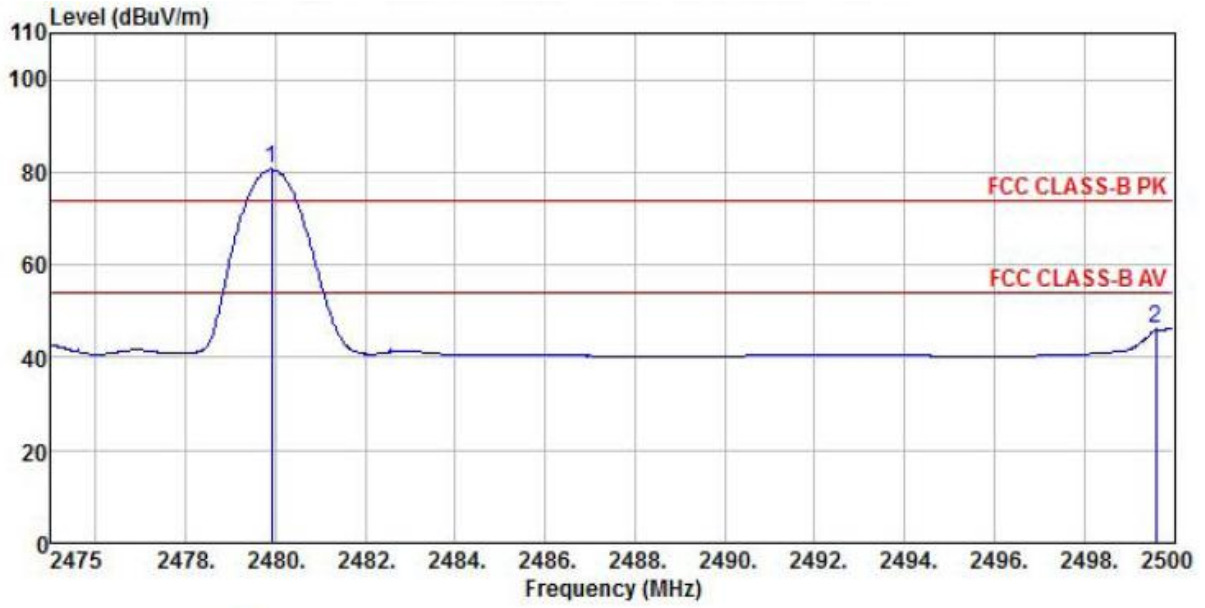

Site : chamber  
 Condition : FCC CLASS-B PK 3m BBHA9120D(RSE-H) HORIZONTAL  
 EUT : GSM/GPRS Wireless Data Module  
 Model Name : SIM800H  
 Temp/Humi : 24°C / 49%  
 Power Rating: AC 120V/60Hz  
 Mode : GFSK Channel 78  
 Memo :

	ReadAntenna	Cable	Preamp	Limit	Over				
Freq	Level	Factor	Loss	Factor	Level	Line	Limit	Remark	
MHz	dBuV	dB/m	dB	dB	dBuV/m	dBuV/m	dB		
1 pp 2479.90	73.12	38.38	7.41	38.31	80.60	54.00	26.60	Average	
2 2499.60	38.70	38.36	7.43	38.30	46.19	54.00	-7.81	Average	

**BT 8-DPSK (Low Channel)**

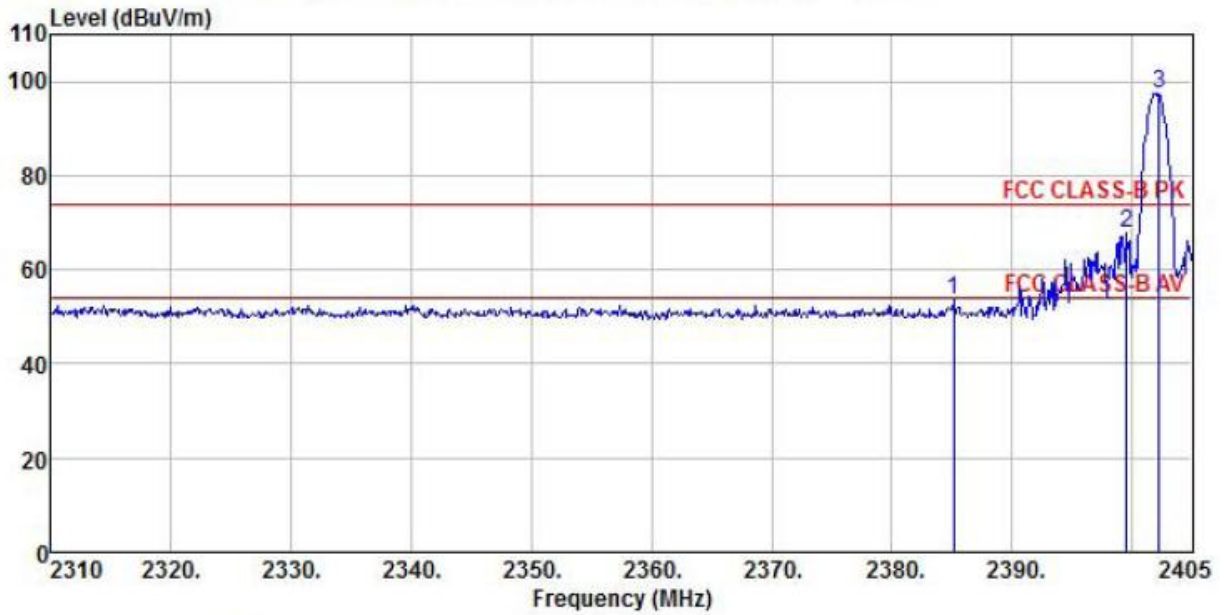

Site : chamber  
 Condition : FCC CLASS-B PK 3m BBHA9120D(RSE-H) HORIZONTAL  
 EUT : GSM/GPRS Wireless Data Module  
 Model Name : SIM800H  
 Temp/Humi : 24°C / 49%  
 Power Rating: AC 120V/60Hz  
 Mode : 8DPSK Channel 0  
 Memo :

	Freq	ReadAntenna Level	Cable Factor	Preamp Loss	Preamp Factor	Limit Level	Limit Line	Over Limit	Remark
	MHz	dBuV	dB/m	dB	dB	dBuV/m	dBuV/m	dB	
1	2385.15	46.70	37.95	7.16	38.35	53.46	74.00	-20.54	Peak
2	2399.59	61.20	37.92	7.13	38.34	67.91	74.00	-6.09	Peak
3 pp	2402.25	90.65	37.92	7.13	38.34	97.36	74.00	23.36	Peak

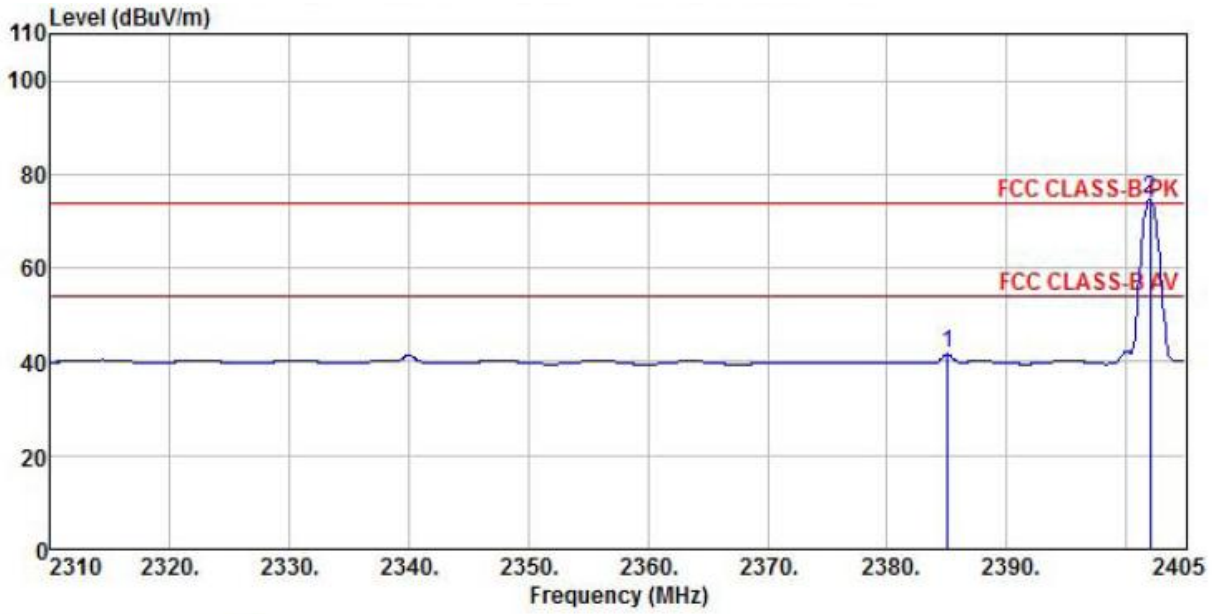

Site : chamber  
 Condition : FCC CLASS-B PK 3m BBHA9120D(RSE-H) HORIZONTAL  
 EUT : GSM/GPRS Wireless Data Module  
 Model Name : SIM800H  
 Temp/Humi : 24°C / 49%  
 Power Rating: AC 120V/60Hz  
 Mode : 8DPSK Channel 0  
 Memo :

	Freq	ReadAntenna Level	Antenna Factor	Cable Loss	Preamplifier Factor	Level	Limit Line	Over Limit	Remark
	MHz	dBuV	dB/m	dB	dB	dBuV/m	dBuV/m	dB	
1	2385.05	34.89	37.95	7.16	38.35	41.65	54.00	-12.35	Average
2 pp	2402.06	68.16	37.92	7.13	38.34	74.87	54.00	20.87	Average

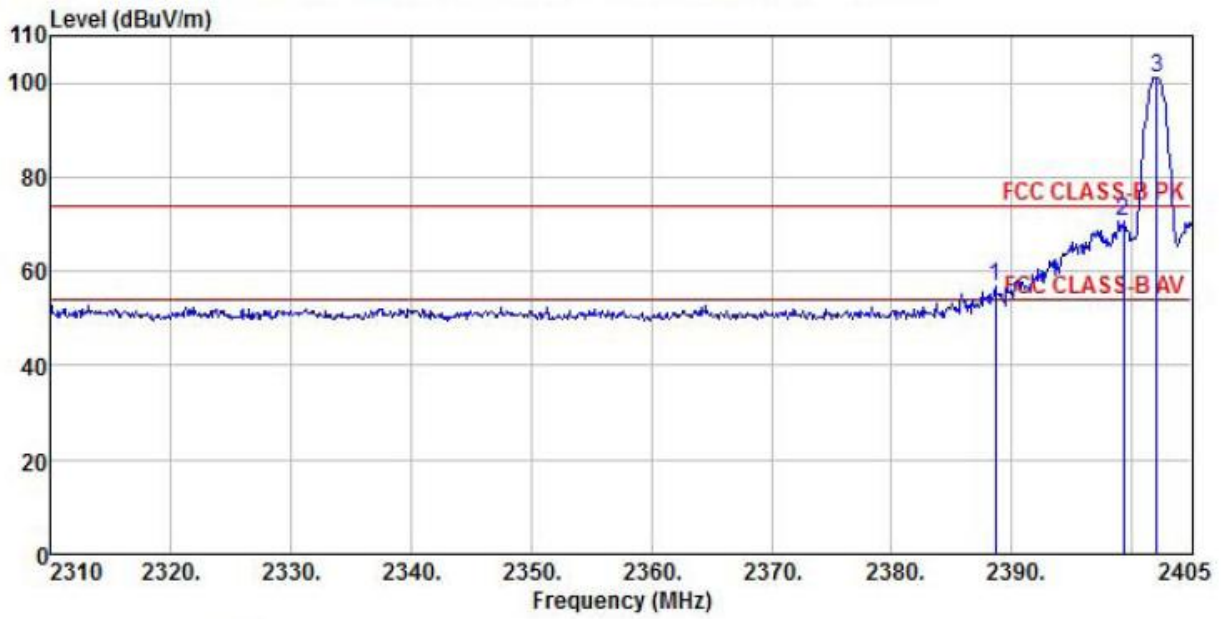

Site : chamber  
 Condition : FCC CLASS-B PK 3m BBHA9120D(RSE-V) VERTICAL  
 EUT : GSM/GPRS Wireless Data Module  
 Model Name : SIM800H  
 Temp/Humi : 24°C / 49%  
 Power Rating: AC 120V/60Hz  
 Mode : 8DPSK Channel 0  
 Memo :

	ReadAntenna	Cable	Preamp	Limit	Over			
Freq	Level	Factor	Loss	Factor	Level	Line	Limit	Remark
MHz	dBuV	dB/m	dB	dB	dBuV/m	dBuV/m	dB	
1	2388.66	49.98	37.92	7.13	38.34	56.69	74.00	-17.31 Peak
2	2399.30	64.08	37.92	7.13	38.34	70.79	74.00	-3.21 Peak
3 pp	2402.15	94.37	37.92	7.13	38.34	101.08	74.00	27.08 Peak

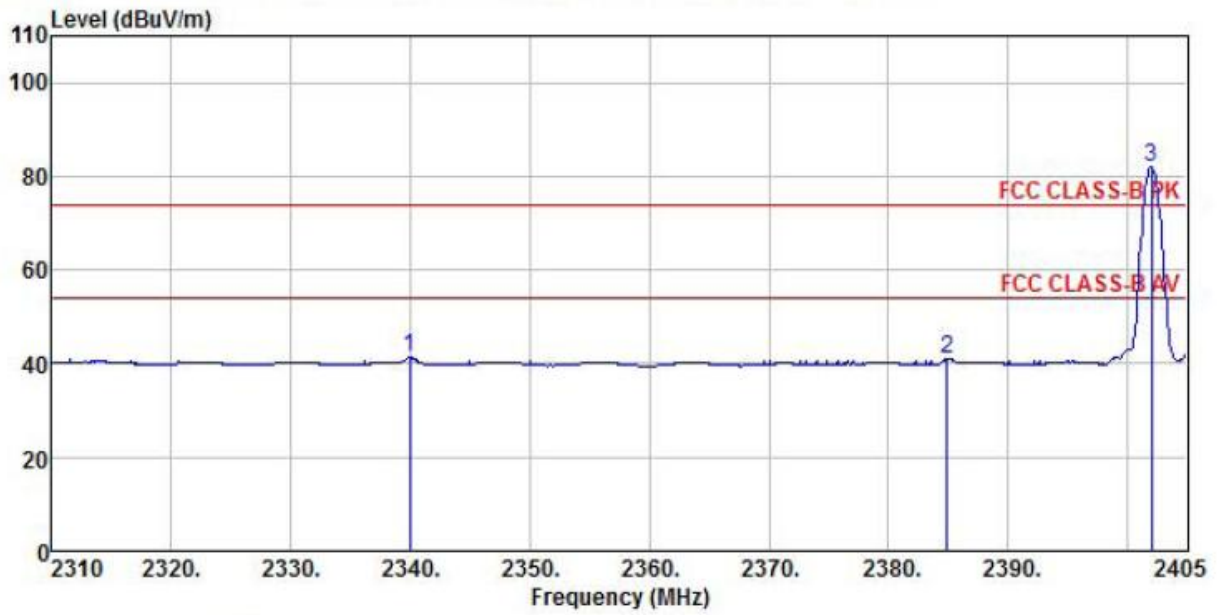

Site : chamber  
 Condition : FCC CLASS-B PK 3m BBHA9120D(RSE-V) VERTICAL  
 EUT : GSM/GPRS Wireless Data Module  
 Model Name : SIM800H  
 Temp/Humi : 24°C / 49%  
 Power Rating: AC 120V/60Hz  
 Mode : 8DPSK Channel 0  
 Memo :

	ReadAntenna	Cable	Preamp		Limit	Over		
Freq	Level	Factor	Loss	Factor	Level	Line	Limit	Remark
MHz	dBuV	dB/m	dB	dB	dBuV/m	dBuV/m	dB	
1	2339.93	34.52	37.99	7.22	38.36	41.37	54.00	-12.63 Average
2	2384.96	34.30	37.95	7.16	38.35	41.06	54.00	-12.94 Average
3 pp	2402.06	75.48	37.92	7.13	38.34	82.19	54.00	28.19 Average

**BT 8-DPSK (High Channel)**

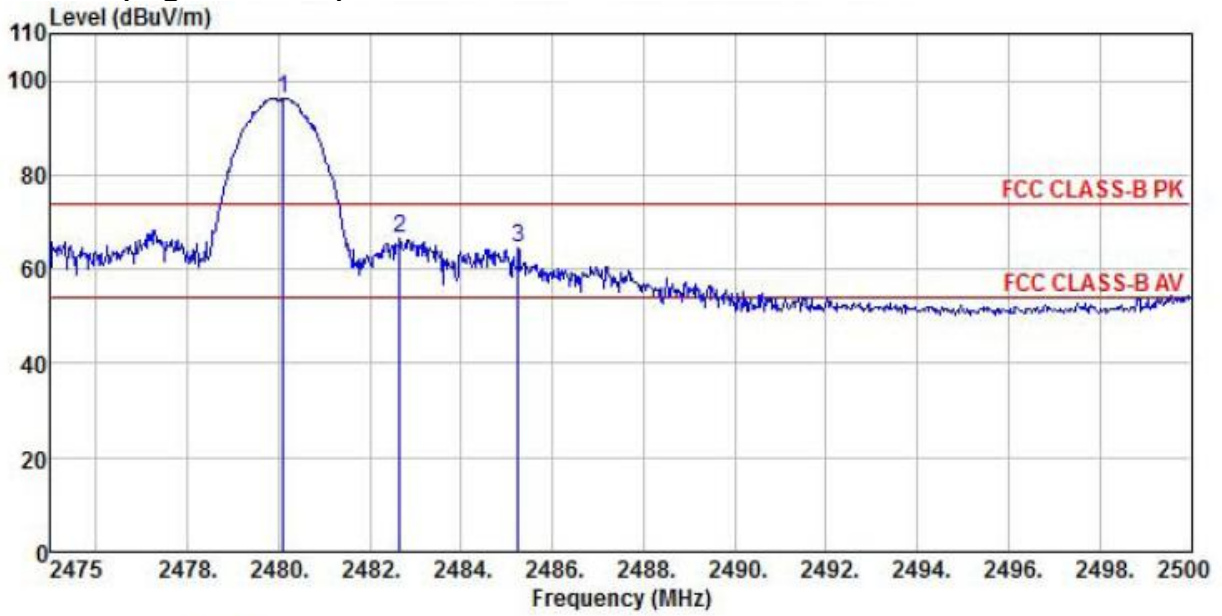

Site : chamber  
 Condition : FCC CLASS-B PK 3m BBHA9120D(RSE-H) HORIZONTAL  
 EUT : GSM/GPRS Wireless Data Module  
 Model Name : SIM800H  
 Temp/Humi : 24°C / 49%  
 Power Rating: AC 120V/60Hz  
 Mode : 8DPSK Channel 78  
 Memo :

	ReadAntenna	Cable	Preamp		Limit	Over	
Freq	Level	Factor	Loss	Factor	Level	Line	Limit
MHz	dBuV	dB/m	dB	dB	dBuV/m	dBuV/m	dB
1 pp 2480.10	88.80	38.38	7.41	38.31	96.28	74.00	22.28 Peak
2 2482.65	58.90	38.38	7.41	38.31	66.38	74.00	-7.62 Peak
3 2485.25	56.91	38.38	7.41	38.31	64.39	74.00	-9.61 Peak

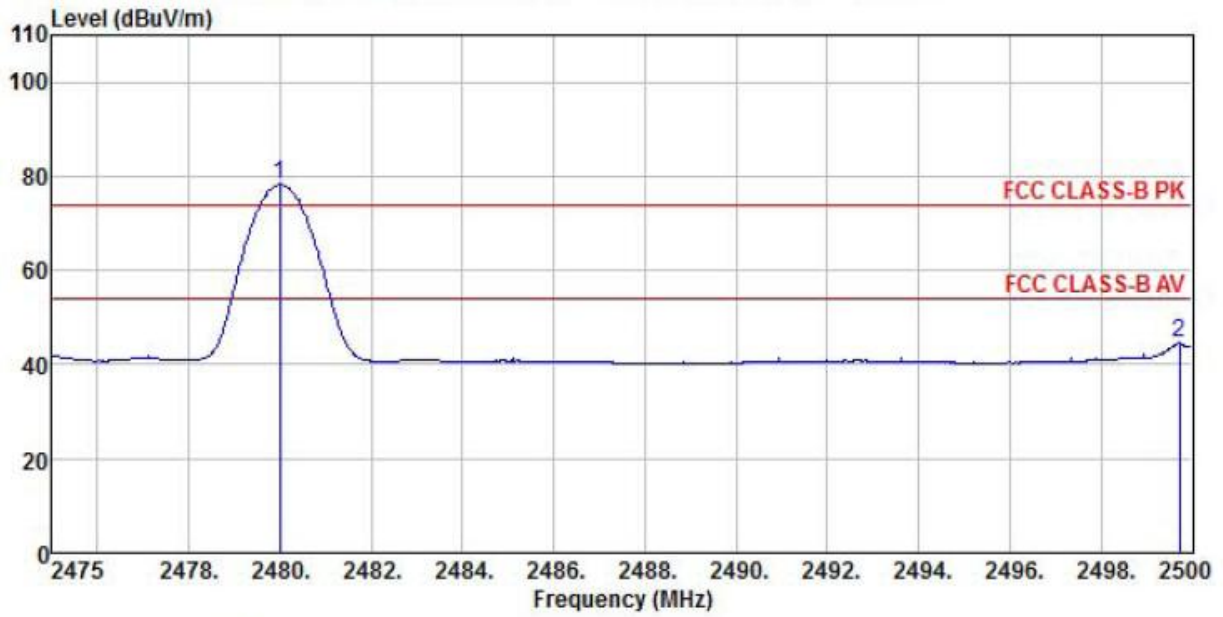

Site : chamber  
 Condition : FCC CLASS-B PK 3m BBHA9120D(RSE-H) HORIZONTAL  
 EUT : GSM/GPRS Wireless Data Module  
 Model Name : SIM800H  
 Temp/Humi : 24°C / 49%  
 Power Rating: AC 120V/60Hz  
 Mode : 8DPSK Channel 78  
 Memo :

	ReadAntenna	Cable	Preamp	Limit	Over			
Freq	Level	Factor	Loss	Factor	Level	Line	Limit	Remark
MHz	dBuV	dB/m	dB	dB	dBuV/m	dBuV/m	dB	
1 pp 2480.00	70.72	38.38	7.41	38.31	78.20	54.00	24.20	Average
2 2499.73	37.21	38.36	7.43	38.30	44.70	54.00	-9.30	Average



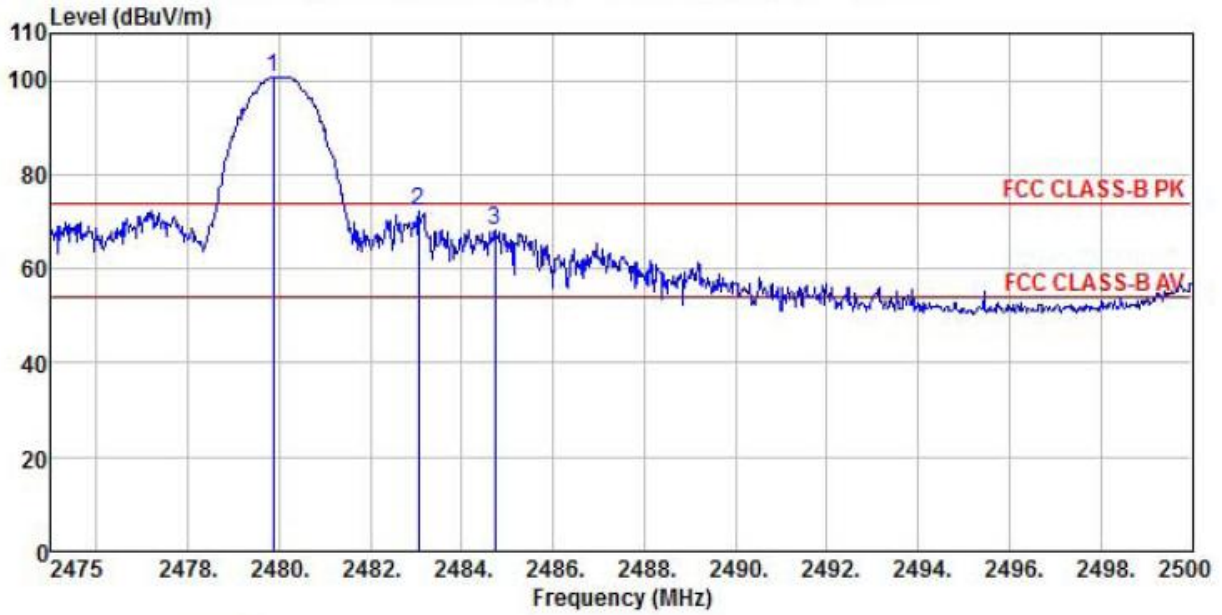

Site : chamber  
 Condition : FCC CLASS-B PK 3m BBHA9120D(RSE-V) VERTICAL  
 EUT : GSM/GPRS Wireless Data Module  
 Model Name : SIM800H  
 Temp/Humi : 24°C / 49%  
 Power Rating: AC 120V/60Hz  
 Mode : 8DPSK Channel 78  
 Memo :

	ReadAntenna	Cable	Preamp		Limit	Over		
Freq	Level	Factor	Loss	Factor	Level	Line	Limit	Remark
MHz	dBuV	dB/m	dB	dB	dBuV/m	dBuV/m	dB	
1 pp 2479.88	93.26	38.38	7.41	38.31	100.74	74.00	26.74	Peak
2 2483.05	64.58	38.38	7.41	38.31	72.06	74.00	-1.94	Peak
3 2484.73	60.88	38.38	7.41	38.31	68.36	74.00	-5.64	Peak

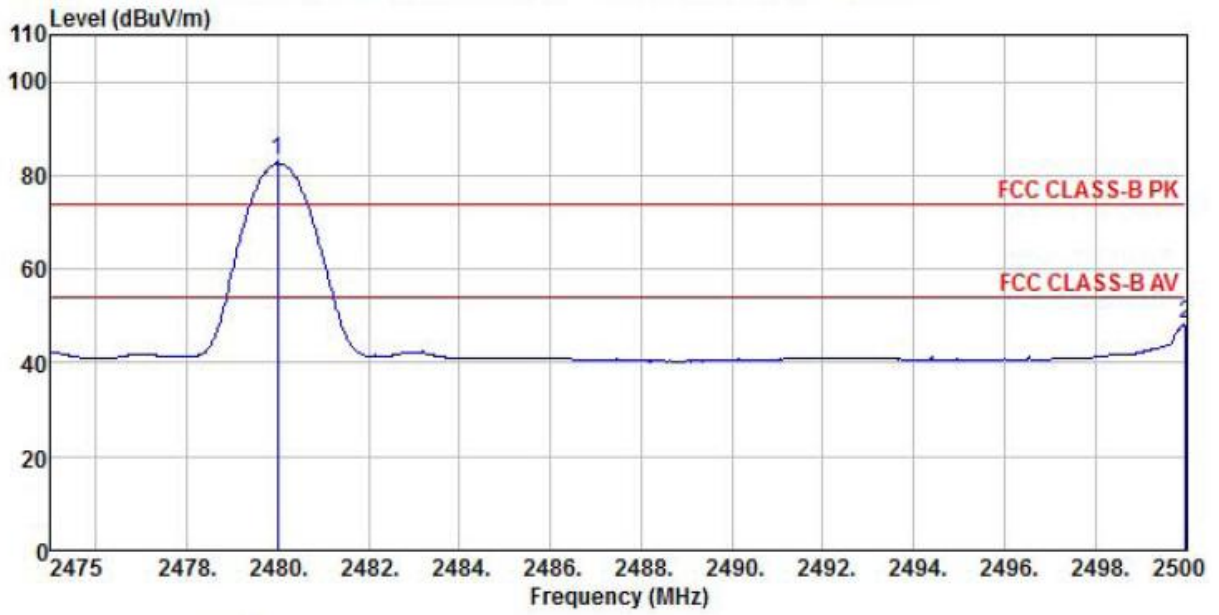

Site : chamber  
 Condition : FCC CLASS-B PK 3m BBHA9120D(RSE-V) VERTICAL  
 EUT : GSM/GPRS Wireless Data Module  
 Model Name : SIM800H  
 Temp/Humi : 24°C / 49%  
 Power Rating: AC 120V/60Hz  
 Mode : 8DPSK Channel 78  
 Memo :

	ReadAntenna	Cable	Preamp	Limit	Over			
Freq	Level	Factor	Loss	Factor	Level	Line	Limit	Remark
MHz	dBuV	dB/m	dB	dB	dBuV/m	dBuV/m	dB	
1 pp 2480.00	75.59	38.38	7.41	38.31	83.07	54.00	29.07	Average
2 2500.00	40.92	38.36	7.43	38.30	48.41	54.00	-5.59	Average

# 11. SPURIOUS EMISSIONS(RADIATION)

## 11.1 TEST SETUP

Radiated Spurious Measurement: below 30MHz

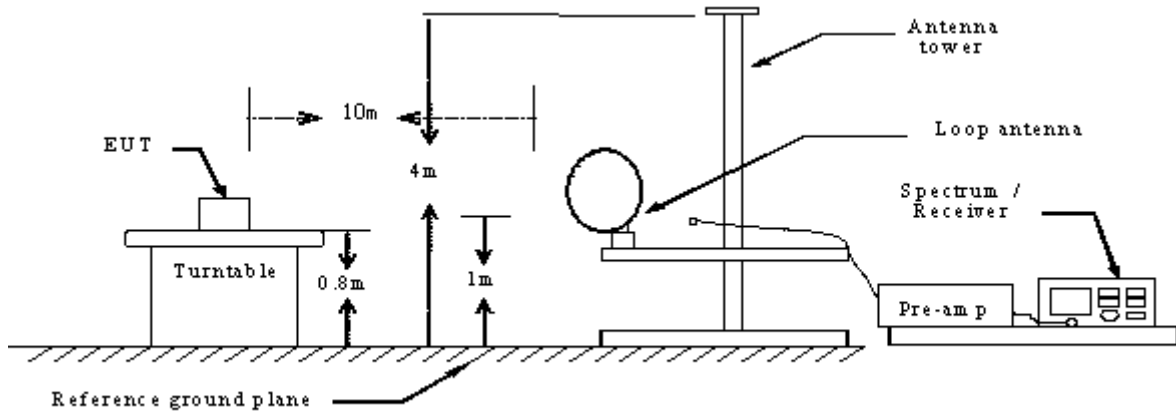

Radiated Spurious Measurement: below 1GHz

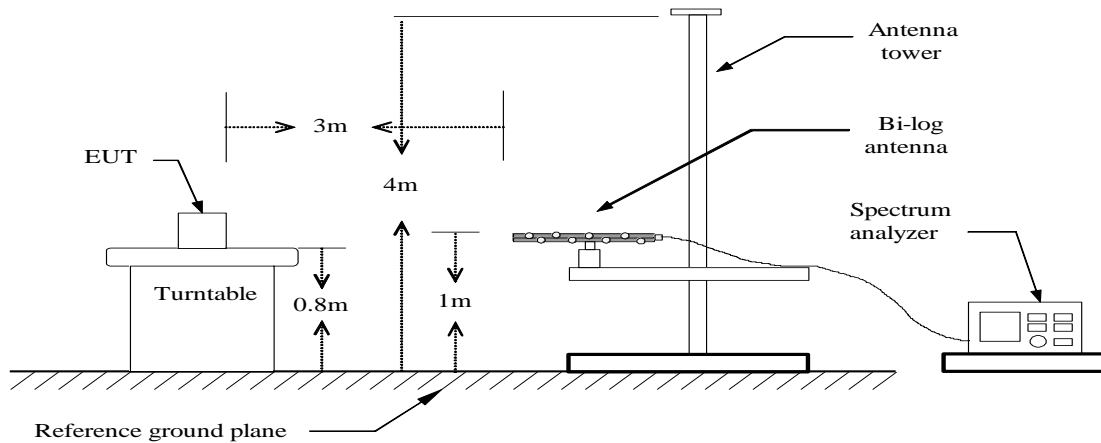

Radiated Spurious Measurement: above 1GHz

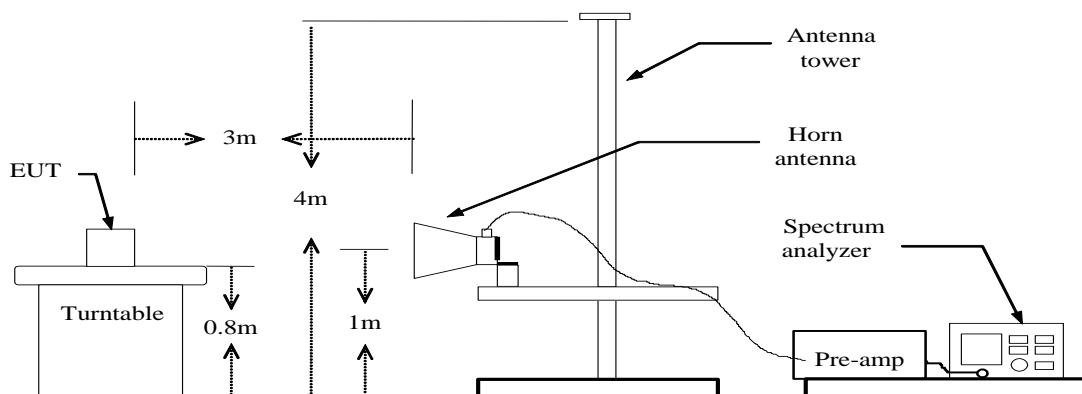

## 11.2 LIMITS

Frequency (MHz)	Limits (dBuV/m)	Measured distance (m)
0.009-0.490	107.6-72.9	10
0.490-1.705	52.8-42.1	
1.705-30.0	49	
30~88	40	3
88~216	43.5	
216-960	46	
Above 960	54	

Notes: the calculate formula for below 30MHz

$$L2 = 20\lg(L1) + 40\lg(d1/d2)$$

L2: is the specified limit in dB microvolts per metre at distance d2.

L1: is the specified limit in microvolts per metre at distance d1.

For example:

L1 = 2400/9 ( $\mu$ V/m), d1 = 300 (m), d2 = 10 (m), so L2 as follows:

$$20\lg(2400/9) + 40\lg(300/10) = 107.6(\text{dB}\mu\text{V/m})$$

## 11.3 TEST PROCEDURE

### Radiated Emission ( 9 kHz - 30 MHz ) :

Spurious emissions from the EUT are measured in the frequency range of 9 kHz to 30 MHz using a tuned receiver and a shielded loop antenna. The antenna was positioned 10 meters horizontally from the EUT. Measurements have been made in all three orthogonal axes and the shielded loop antenna was rotated to locate the maximum of the emissions. The emission limits are based on measurements employing a CISPR quasi-peak detector except for the frequency bands 9-90 kHz, 110-490 kHz.

### Radiated Emission ( 30 MHz - 1000 MHz ) :

According to description of ANSI C63.4: 2009 sec.13.4, the preliminary radiated emissions measurement were carried out. The preliminary radiated measurements were performed at the measurement distance that specified for compliance to determine the emission characteristics of the EUT. The EUT configuration (in X, Y and Z axis), cable configuration and mode of operation were determined for producing the maximum level of emissions. These configurations were used for the final radiated emissions measurements. The measurement is carried out using a spectrum analyzer or receiver. The Quasi-peak detector is used and RBW is set to 120kHz. The antenna height and turn table rotation is adjusted until the maximum power value is founded on spectrum analyzer or receiver.

**Radiated Emission (Above 1 GHz) :**

According to description of ANSI C63.4: 2009 sec.13.4, the preliminary radiated emissions measurement were carried out. The preliminary radiated measurements were performed at the measurement distance that specified for compliance to determine the emission characteristics of the EUT. The EUT configuration (in X, Y and Z axis), cable configuration and mode of operation were determined for producing the maximum level of emissions. These configurations were used for the final radiated emissions measurements. The measurement is carried out using a spectrum analyzer or receiver. The spectrum analyzer scans from 1GHz to 25GHz (higher than the 10<sup>th</sup> harmonic of the carrier). The peak detector is used for Peak limit and RBW is set to 1MHz ,VBW  $\geq$  3RBW. The peak detector is used for Average limit and RBW is set to 1MHz ,VBW is not smaller than 1/T, T = to the shortest pulse width. The antenna height and turn table rotation is adjusted until the maximum power value is founded on spectrum analyzer or receiver.

### 11.4 RESULTS & PERFORMANCE

**From 9KHz to 30MHz:**

Bluetooth GFSK, traffic mode; Channel 0

H:

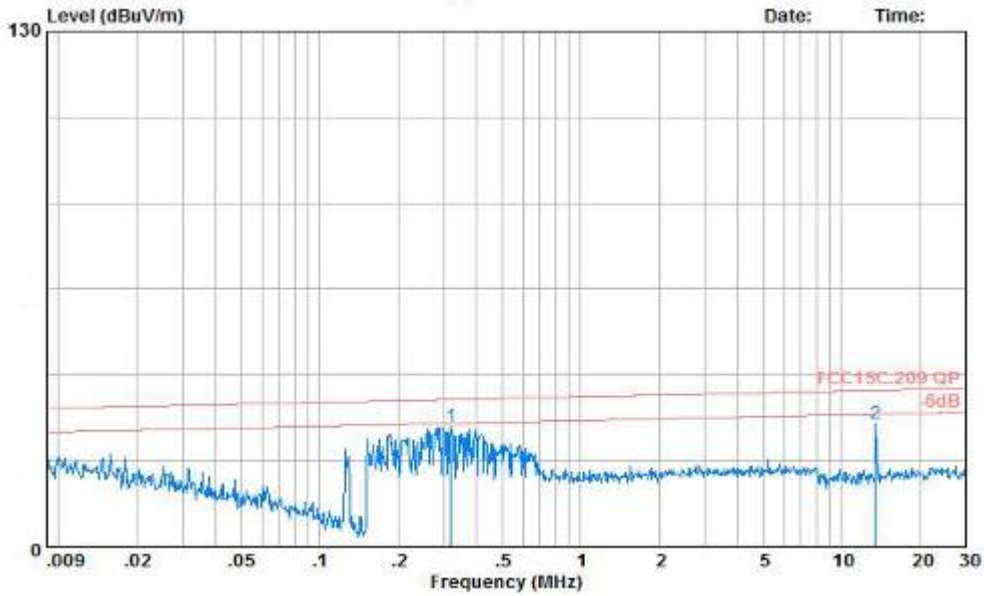

V:

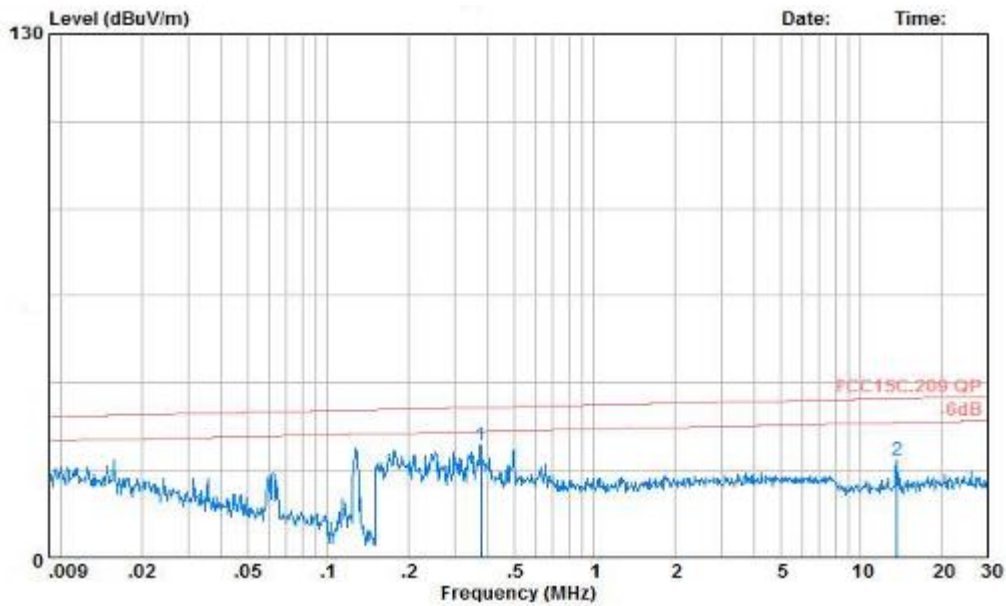

Frequency (MHz)	Polarization (H/V)	Reading (dBuV)	Correction Factor (dB/m)	Measure Level (dBuV/m)	Limit (dBuV/m)	Over Limit (dB)	Detector
0.31	H	10.58	19.53	24.95	76.8	-46.69	Peak
0.37	V	8.16	19.66	28.87	75.3	-46.43	Peak
13.54	H	10.76	18.14	24.2	49.0	-20.1	Peak
13.65	V	4.65	18.43	26.47	49.0	-25.92	Peak

H: Horizontal V: Vertical

Measure Level(dBuV/m) = Reading (dBuV) + Correction Factor (dB/m)

Bluetooth GFSK, traffic mode; Channel 78

H:

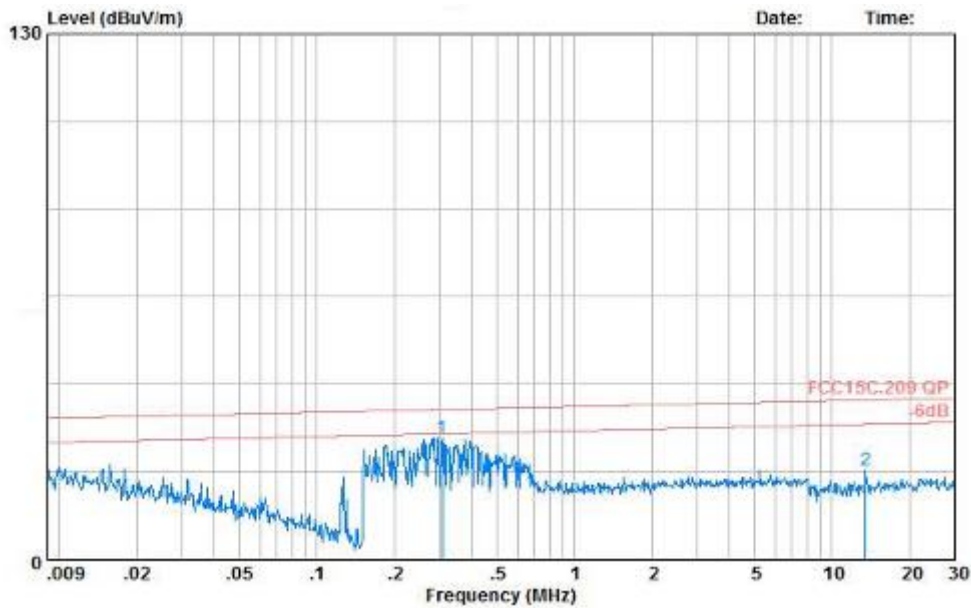

V:

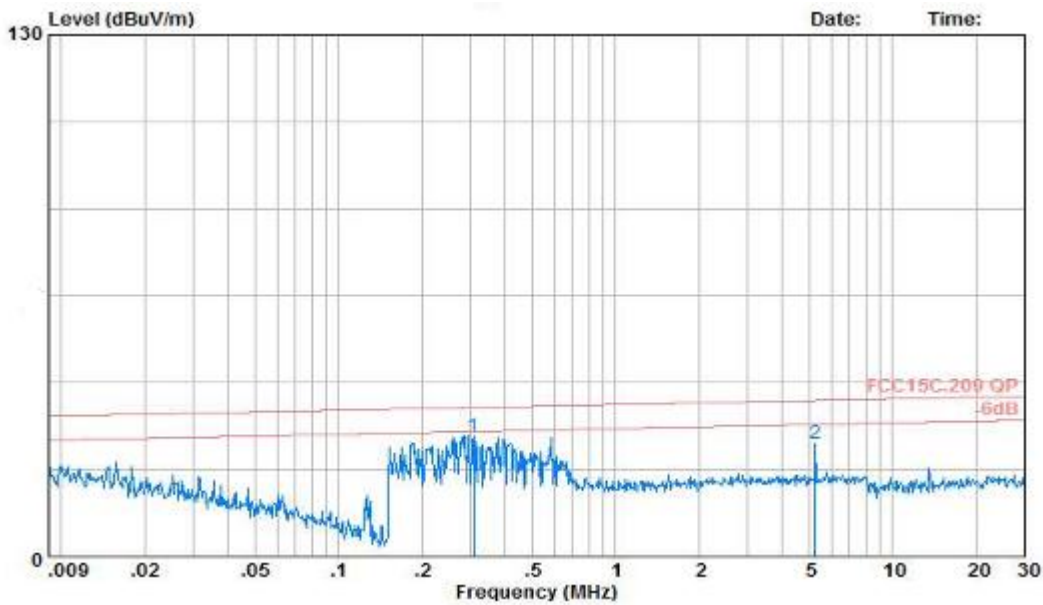

Frequency (MHz)	Polarization (H/V)	Reading (dBuV)	Correction Factor (dB/m)	Measure Level (dBuV/m)	Limit (dBuV/m)	Over Limit (dB)	Detector
0.30	H	10.37	16.89	24.95	77.1	-49.84	Peak
0.30	V	10.37	16.34	28.87	77.1	-50.39	Peak
13.54	H	3.52	18.53	24.2	49.0	-26.95	Peak
5.2	V	13.26	13.21	26.47	49.0	-22.53	Peak

H: Horizontal V: Vertical

Measure Level(dBuV/m) = Reading (dBuV) + Correction Factor (dB/m)

Bluetooth 8-DPSK, traffic mode; Channel 0  
H:

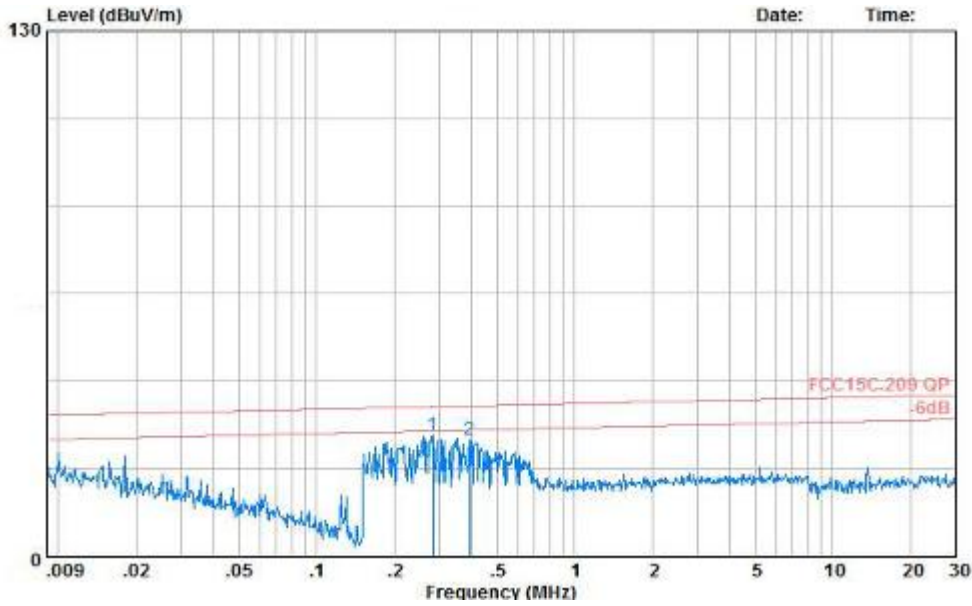

V:

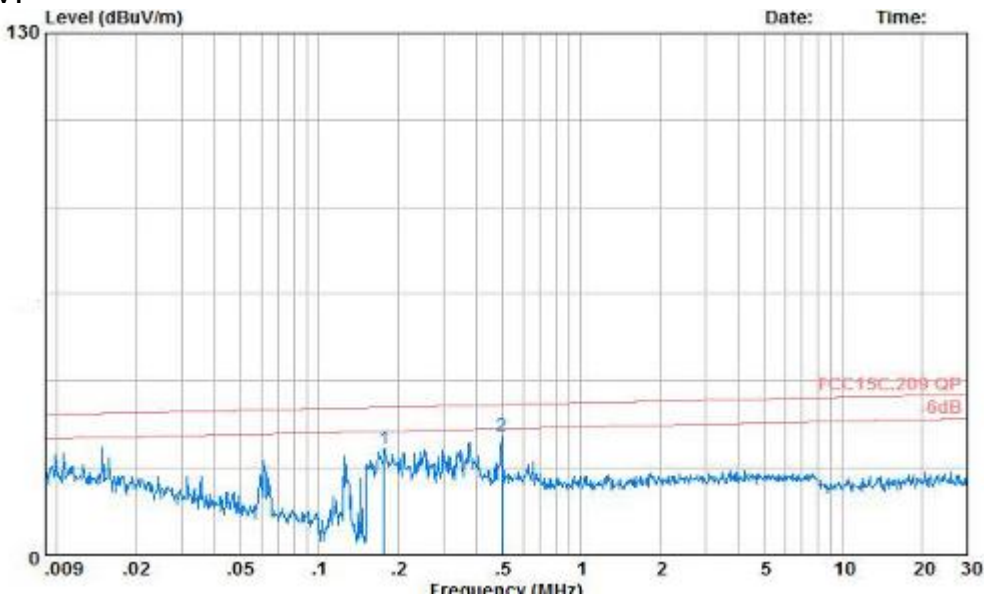

Frequency (MHz)	Polarization (H/V)	Reading (dBuV)	Correction Factor (dB/m)	Measure Level (dBuV/m)	Limit (dBuV/m)	Over Limit (dB)	Detector
0.28	H	10.24	18.85	29.09	77.2	-48.2	Peak
0.17	V	6.89	17.92	24.81	76.5	-51.69	Peak
0.39	H	9.22	19.44	28.66	75.3	-46.34	Peak
0.49	V	9.98	18.21	28.19	72.3	-44.11	Peak

H: Horizontal V: Vertical

$$\text{Measure Level(dBuV/m)} = \text{Reading (dBuV)} + \text{Correction Factor (dB/m)}$$



Bluetooth 8-DPSK, traffic mode; Channel 78

H:

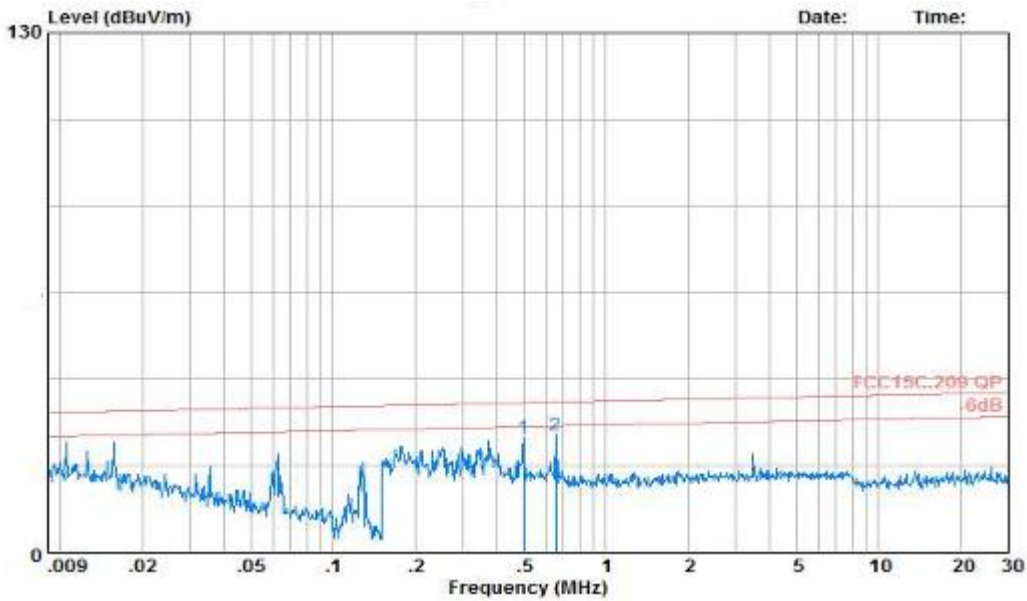

V:

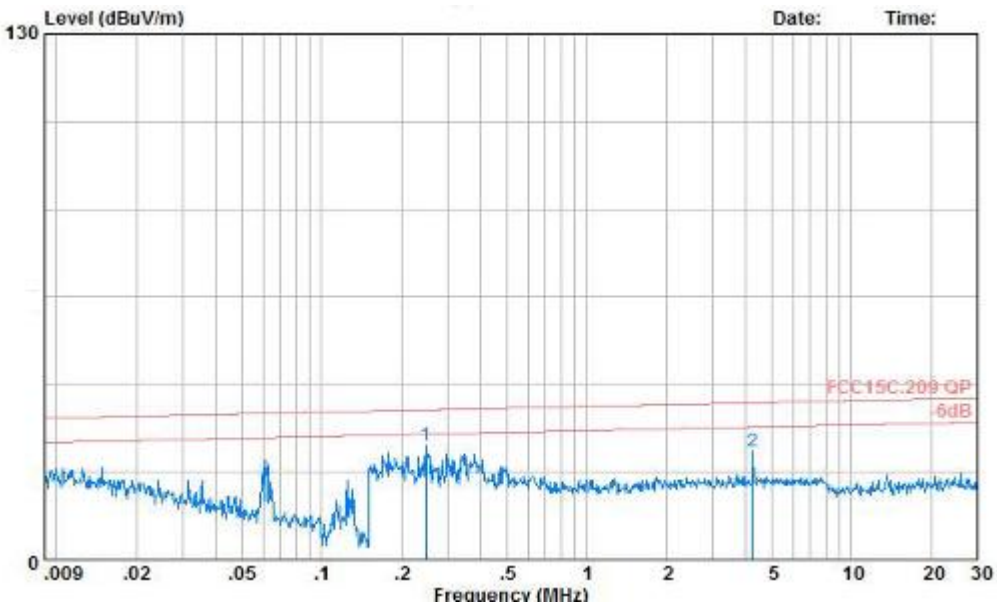

Frequency (MHz)	Polarization (H/V)	Reading (dBuV)	Correction Factor (dB/m)	Measure Level (dBuV/m)	Limit (dBuV/m)	Over Limit (dB)	Detector
0.49	H	12.04	12.91	24.95	72.3	-47.8	Peak
0.24	V	17.39	11.48	28.87	78.2	-49.33	Peak
0.65	H	10.76	13.44	24.2	63.5	-38.8	Peak
4.24	V	13.26	13.21	26.47	49.0	-22.47	Peak

H: Horizontal V: Vertical

Measure Level(dBuV/m) = Reading (dBuV) + Correction Factor (dB/m)

**From 30MHz to 1GHz:**  
Bluetooth GFSK, traffic mode; Channel 0

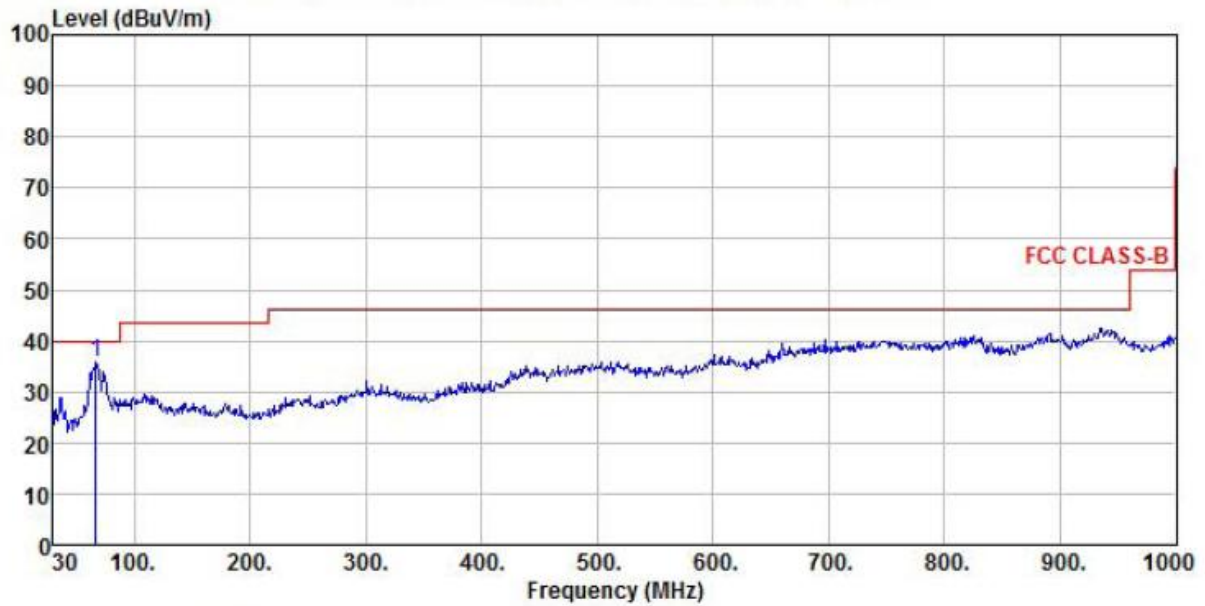

Site : chamber  
 Condition : FCC CLASS-B 3m VULB9160(RSE-V) VERTICAL  
 EUT : GSM/GPRS Wireless Data Module  
 Model Name : SIM800H  
 Temp/Humi : 24°C / 49%  
 Power Rating: AC 120V/60Hz  
 Mode : GFSK Channel 0  
 Memo :

1	pp	Freq	ReadAntenna		Cable Preamp		Limit	Over	Remark
			Level	Factor	Loss	Factor			
		MHz	dBuV	dB/m	dB	dB	dBuV/m	dBuV/m	dB
		66.86	9.04	25.62	1.10	0.00	35.76	40.00	-4.24 Peak

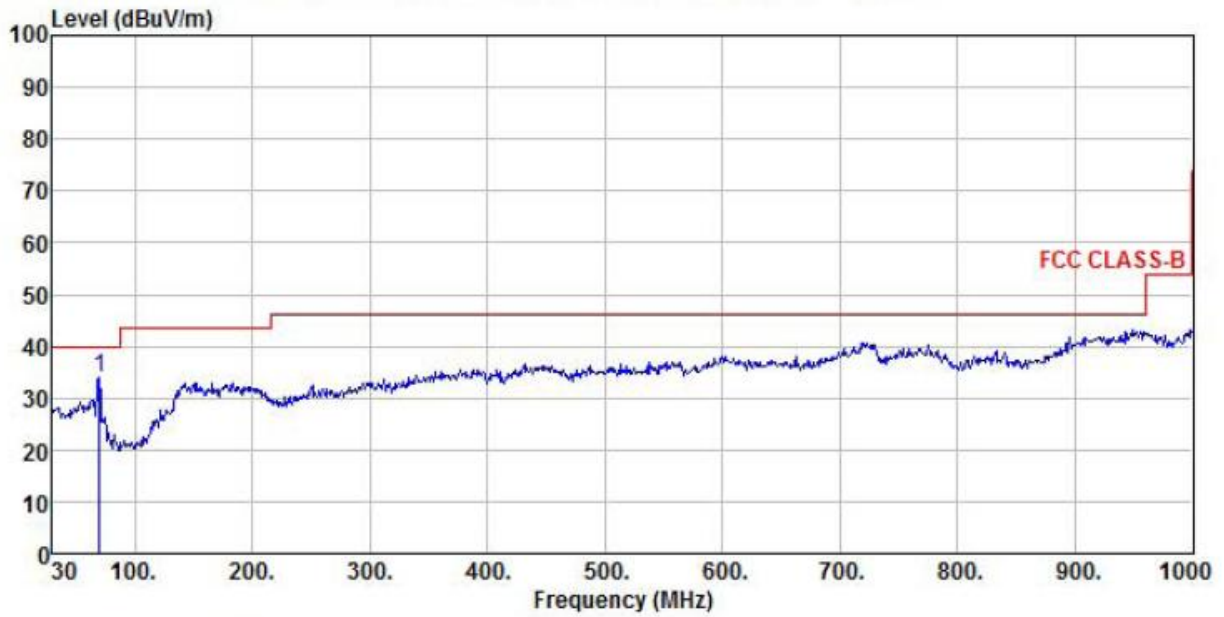

Site : chamber  
 Condition : FCC CLASS-B 3m VULB9160(RSE-H) HORIZONTAL  
 EUT : GSM/GPRS Wireless Data Module  
 Model Name : SIM800H  
 Temp/Humi : 24°C / 49%  
 Power Rating: AC 120V/60Hz  
 Mode : GFSK Channel 0  
 Memo :

	ReadAntenna	Cable	Preamp		Limit	Over	
Freq	Level	Factor	Loss	Factor	Level	Line	Limit Remark
MHz	dBuV	dB/m	dB	dB	dBuV/m	dBuV/m	dB
1 pp 69.77	12.00	20.80	1.12	0.00	33.92	40.00	-6.08 Peak

Bluetooth GFSK, traffic mode; Channel 39

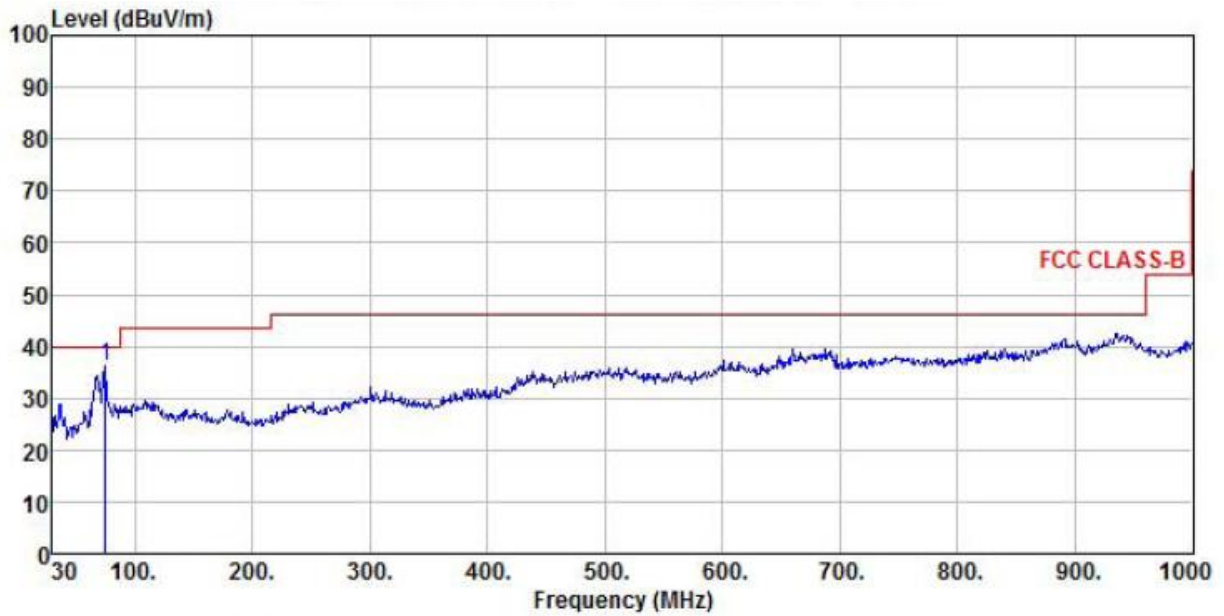

Site : chamber  
 Condition : FCC CLASS-B 3m VULB9160(RSE-V) VERTICAL  
 EUT : GSM/GPRS Wireless Data Module  
 Model Name : SIM800H  
 Temp/Humi : 24°C / 49%  
 Power Rating: AC 120V/60Hz  
 Mode : GFSK Channel 39  
 Memo :

	ReadAntenna	Cable	Preamp		Limit	Over	
Freq	Level	Factor	Loss	Factor	Level	Line	Limit Remark
MHz	dBuV	dB/m	dB	dB	dBuV/m	dBuV/m	dB
1 pp 74.62	11.20	23.91	1.11	0.00	36.22	40.00	-3.78 Peak

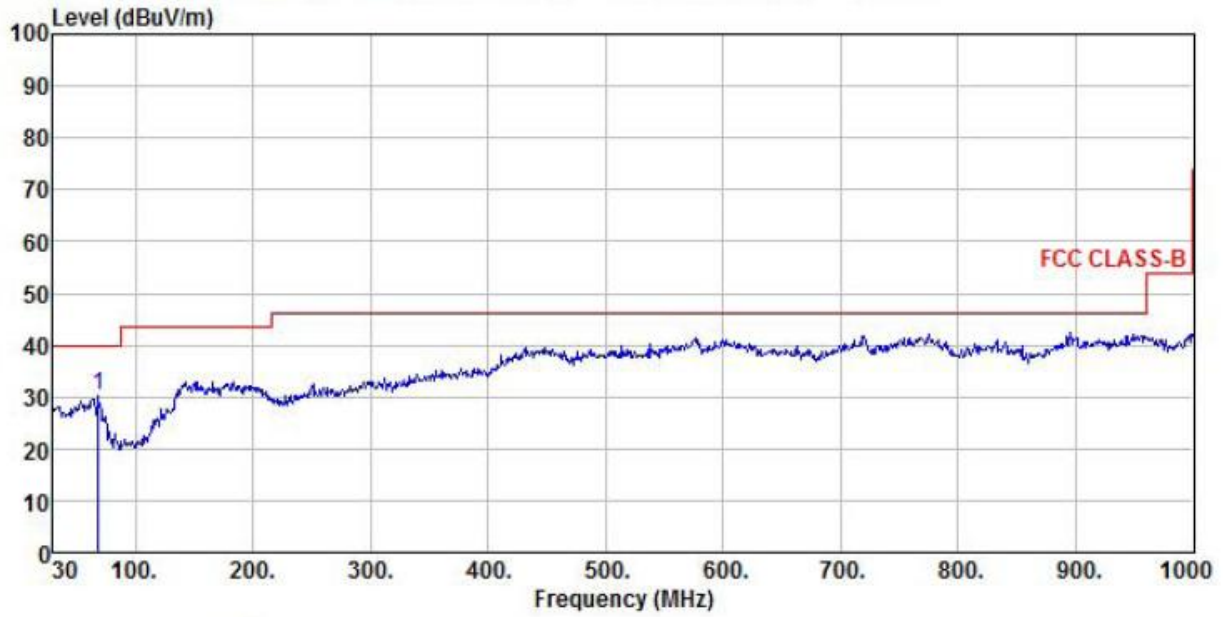

Site : chamber  
 Condition : FCC CLASS-B 3m VULB9160(RSE-H) HORIZONTAL  
 EUT : GSM/GPRS Wireless Data Module  
 Model Name : SIM800H  
 Temp/Humi : 24°C / 49%  
 Power Rating: AC 120V/60Hz  
 Mode : GFSK Channel 39  
 Memo :

	ReadAntenna	Cable	Preamp		Limit	Over	
Freq	Level	Factor	Loss	Factor	Level	Line	Limit
MHz	dBuV	dB/m	dB	dB	dBuV/m	dBuV/m	dB
1 pp 68.80	7.96	21.25	1.11	0.00	30.32	40.00	-9.68 Peak

Bluetooth GFSK, traffic mode; Channel 78

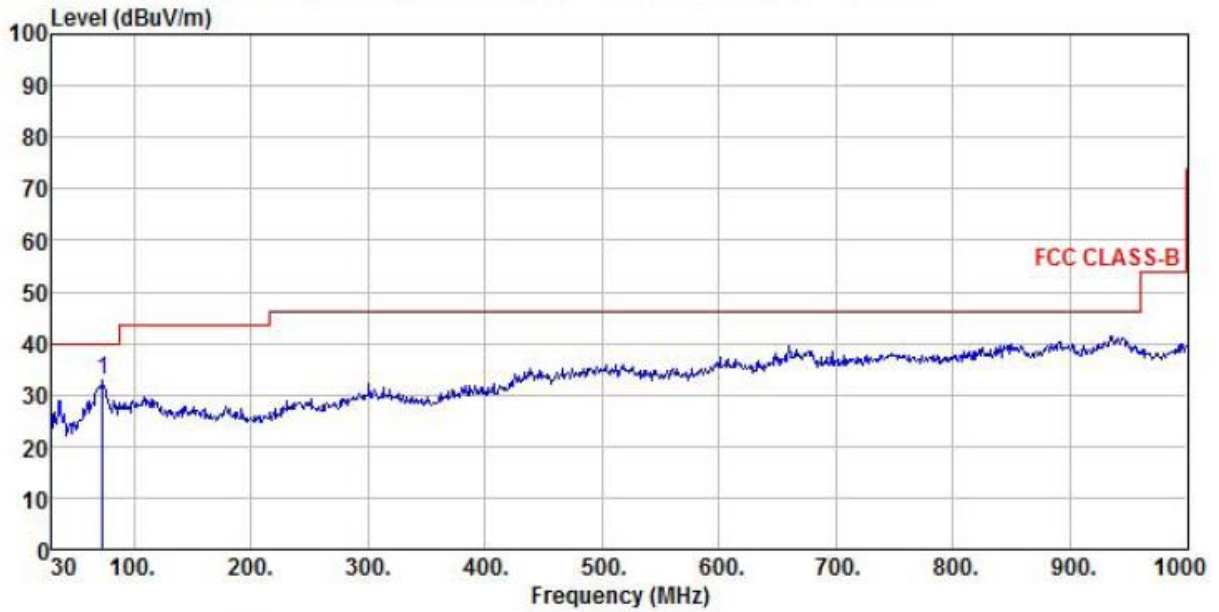

Site : chamber  
 Condition : FCC CLASS-B 3m VULB9160(RSE-V) VERTICAL  
 EUT : GSM/GPRS Wireless Data Module  
 Model Name : SIM800H  
 Temp/Humi : 24°C / 49%  
 Power Rating: AC 120V/60Hz  
 Mode : GFSK Channel 78  
 Memo :

	ReadAntenna	Cable	Preamp	Limit	Over	
Freq	Level	Loss	Factor	Line	Limit	Remark
MHz	dBuV	dB/m	dB	dB	dBuV/m	dB
1 pp 73.65	7.35	24.30	1.12	0.00	32.77	40.00 -7.23 Peak

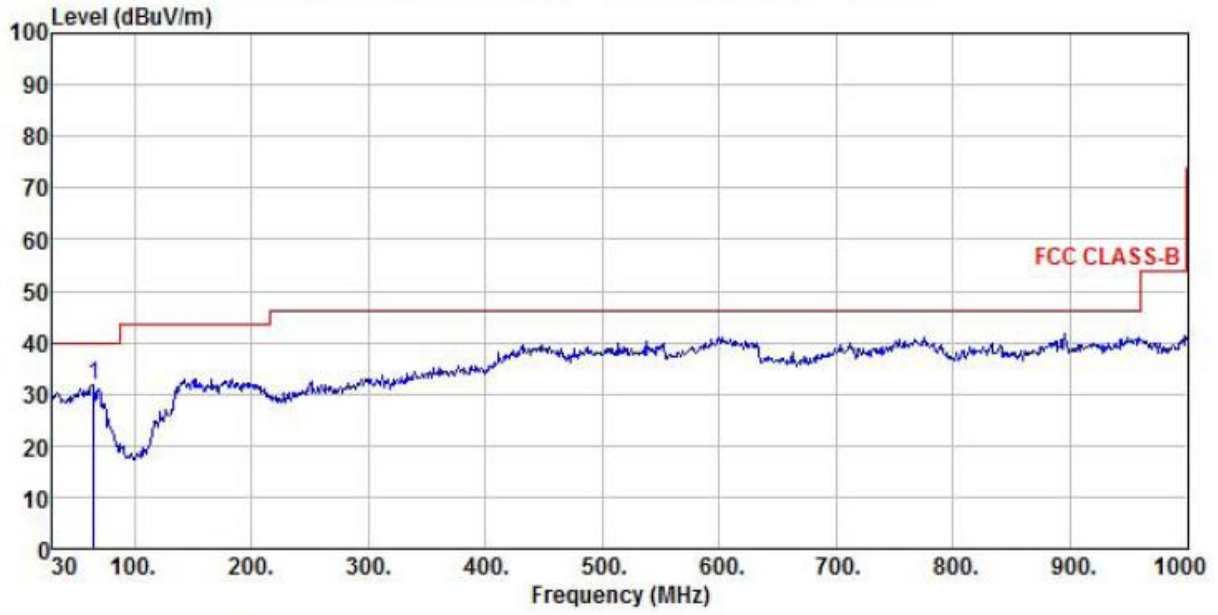

Site : chamber  
 Condition : FCC CLASS-B 3m VULB9160(RSE-H) HORIZONTAL  
 EUT : GSM/GPRS Wireless Data Module  
 Model Name : SIM800H  
 Temp/Humi : 24°C / 49%  
 Power Rating: AC 120V/60Hz  
 Mode : GFSK Channel 78  
 Memo :

	ReadAntenna	Cable	Preamp		Limit	Over	
Freq	Level	Loss	Factor	Level	Line	Limit	Remark
MHz	dBuV	dB/m	dB	dB	dBuV/m	dBuV/m	dB
1 pp	64.92	7.52	23.07	1.08	0.00	31.67	40.00 -8.33 Peak

Bluetooth 8-DPSK, traffic mode; Channel 0

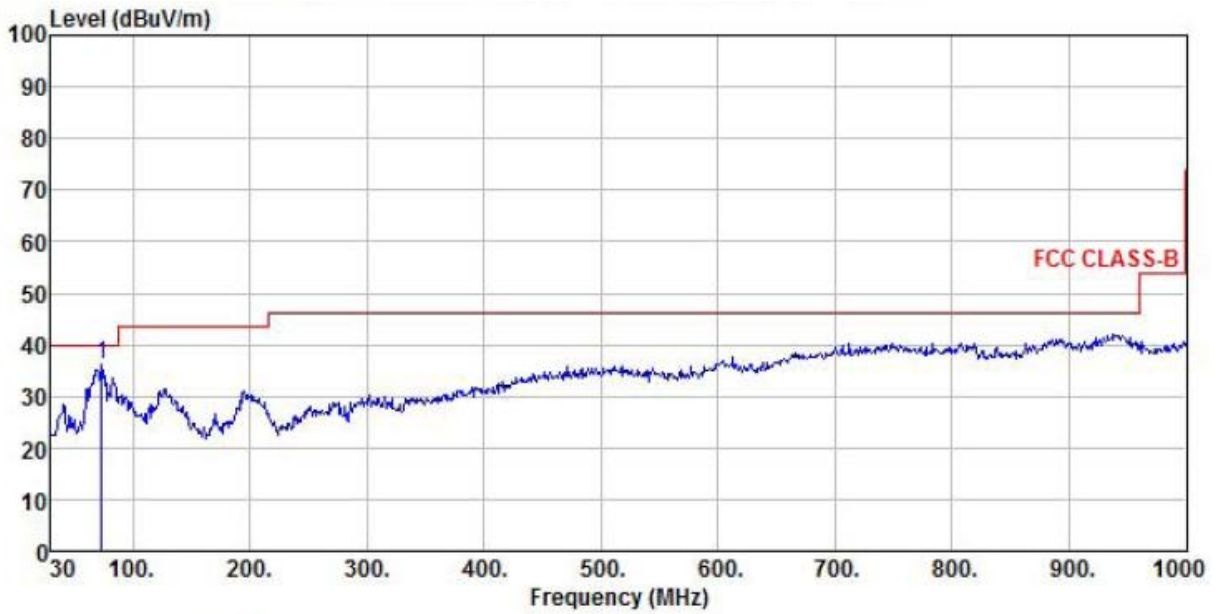

Site : chamber  
 Condition : FCC CLASS-B 3m VULB9160(RSE-V) VERTICAL  
 EUT : GSM/GPRS Wireless Data Module  
 Model Name : SIM800H  
 Temp/Humi : 24°C / 49%  
 Power Rating: AC 120V/60Hz  
 Mode : 8DPSK Channel 0  
 Memo :

	ReadAntenna	Cable	Preamp	Limit	Over		
Freq	Level	Factor	Loss	Factor	Level	Line	Limit Remark
MHz	dBuV	dB/m	dB	dB	dBuV/m	dBuV/m	dB
1 pp 73.65	10.90	24.30	1.12	0.00	36.32	40.00	-3.68 Peak



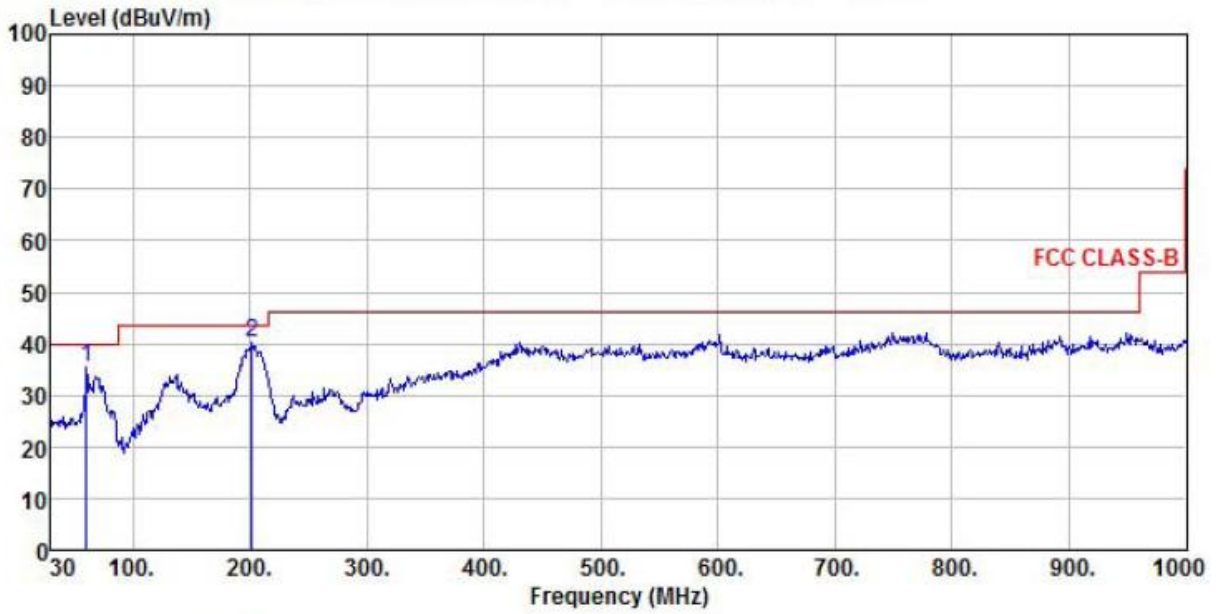

Site : chamber  
 Condition : FCC CLASS-B 3m VULB9160(RSE-H) HORIZONTAL  
 EUT : GSM/GPRS Wireless Data Module  
 Model Name : SIM800H  
 Temp/Humi : 24°C / 49%  
 Power Rating: AC 120V/60Hz  
 Mode : 8DPSK Channel 0  
 Memo :

	ReadAntenna	Cable	Preamp		Limit	Over	
Freq	Level	Factor	Loss	Factor	Level	Line	Limit Remark
MHz	dBuV	dB/m	dB	dB	dBuV/m	dBuV/m	dB
1	60.07	9.11	25.35	1.05	0.00	35.51	40.00 -4.49 Peak
2 pp	201.69	10.60	27.56	1.90	0.00	40.06	43.50 -3.44 Peak

Bluetooth 8-DPSK, traffic mode; Channel 39

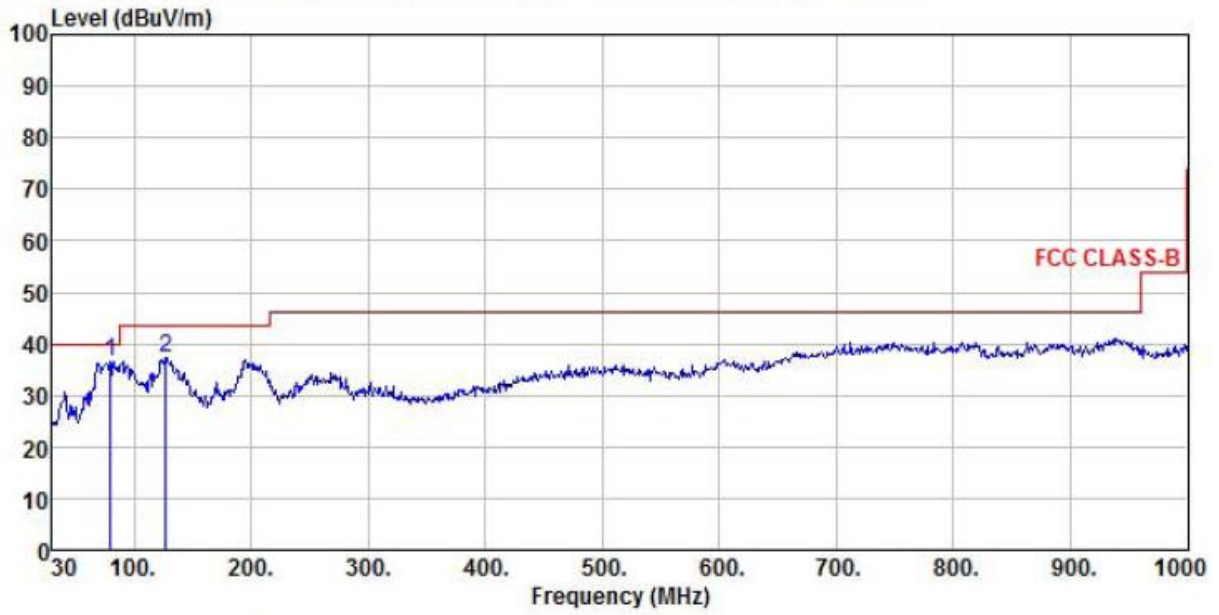

Site : chamber  
 Condition : FCC CLASS-B 3m VULB9160(RSE-V) VERTICAL  
 EUT : GSM/GPRS Wireless Data Module  
 Model Name : SIM800H  
 Temp/Humi : 24°C / 49%  
 Power Rating: AC 120V/60Hz  
 Mode : 8DPSK Channel 39  
 Memo :

	Freq	ReadAntenna	Cable	Preamp	Limit	Over		
	MHz	Level	Factor	Loss	Factor	Level	Line	
		dBuV	dB/m	dB	dB	dBuV/m	dBuV/m	
1 pp	79.47	13.47	21.95	1.09	0.00	36.51	40.00	-3.49 Peak
2	127.00	12.89	23.00	1.56	0.00	37.45	43.50	-6.05 Peak

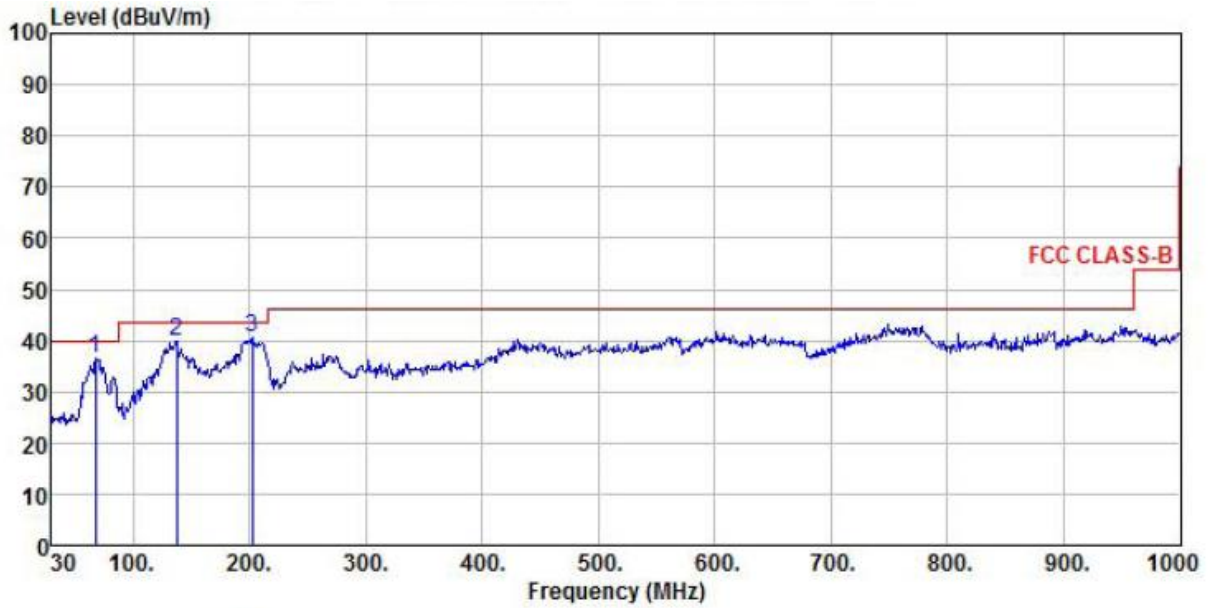

Site : chamber  
 Condition : FCC CLASS-B 3m VULB9160(RSE-H) HORIZONTAL  
 EUT : GSM/GPRS Wireless Data Module  
 Model Name : SIM800H  
 Temp/Humi : 24°C / 49%  
 Power Rating: AC 120V/60Hz  
 Mode : 8DPSK Channel 39  
 Memo :

	Freq	ReadAntenna Level	Cable Loss	Preamp Factor	Limit Line	Over Limit	Remark
	MHz	dBuV	dB/m	dB	dB	dB	
1	67.83	13.75	21.71	1.11	0.00	36.57	40.00 -3.43 Peak
2	137.67	11.39	26.84	1.62	0.00	39.85	43.50 -3.65 Peak
3 pp	202.66	11.30	27.41	1.90	0.00	40.61	43.50 -2.89 Peak

Bluetooth 8-DPSK, traffic mode; Channel 78

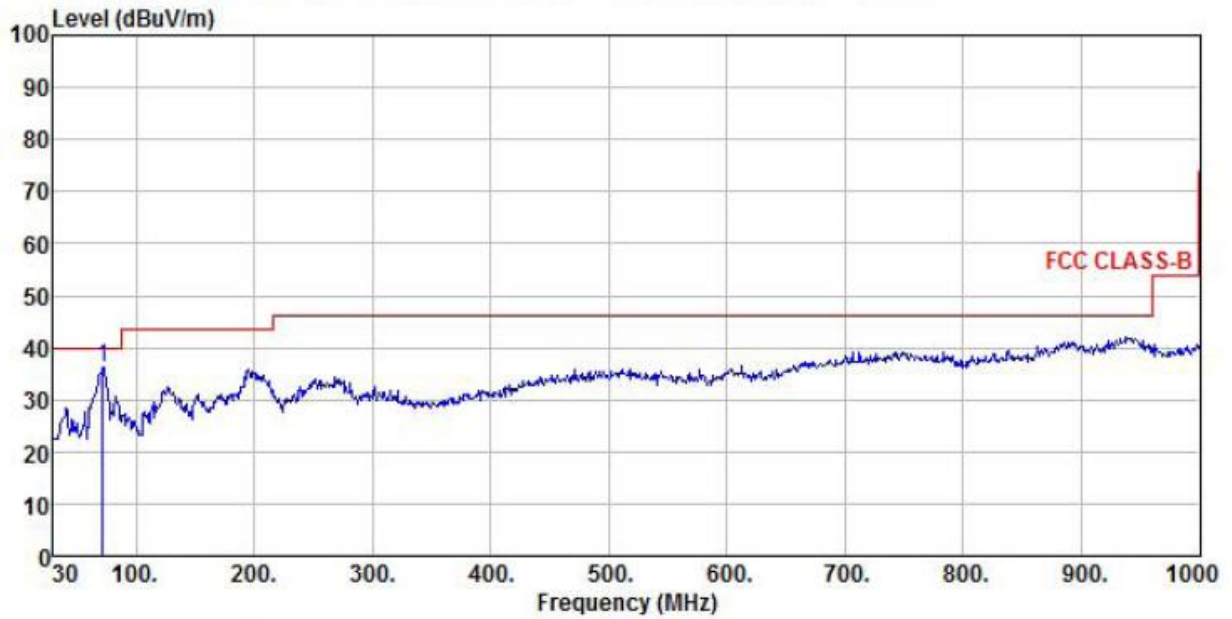

Site : chamber  
 Condition : FCC CLASS-B 3m VULB9160(RSE-V) VERTICAL  
 EUT : GSM/GPRS Wireless Data Module  
 Model Name : SIM800H  
 Temp/Humi : 24°C / 49%  
 Power Rating: AC 120V/60Hz  
 Mode : 8DPSK Channel 78  
 Memo :

	ReadAntenna	Cable	Preamp		Limit	Over	
Freq	Level	Factor	Loss	Factor	Level	Line	Limit Remark
MHz	dBuV	dB/m	dB	dB	dBuV/m	dBuV/m	dB
1 pp	71.71	10.00	25.08	1.13	0.00	36.21	40.00 -3.79 Peak

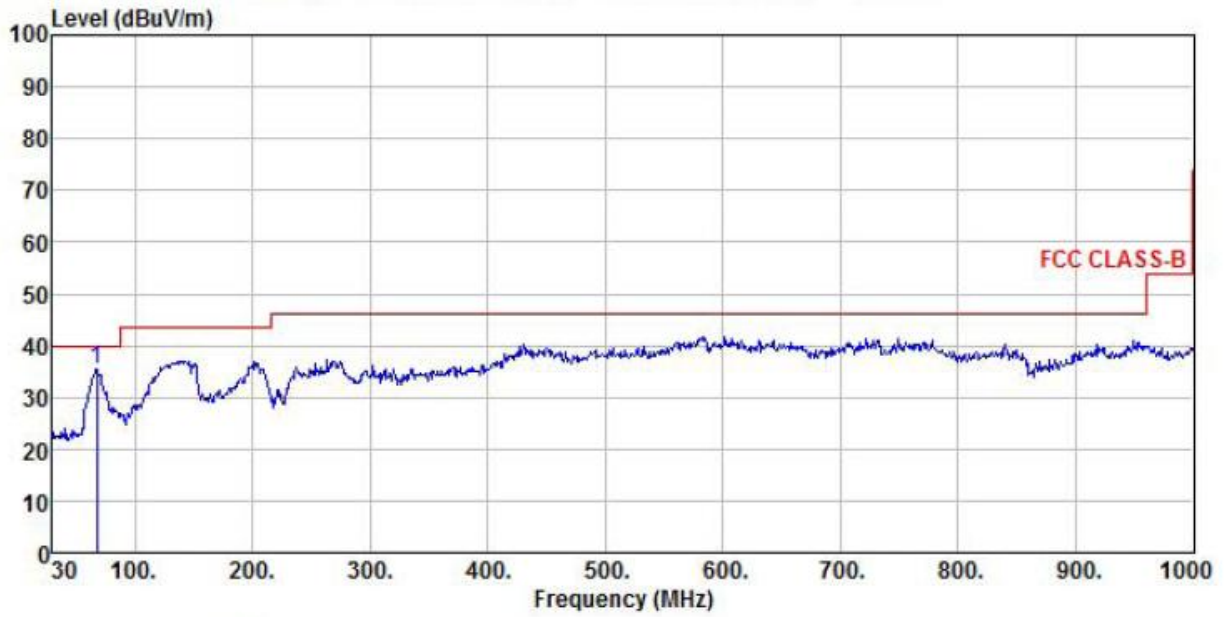

Site : chamber  
 Condition : FCC CLASS-B 3m VULB9160(RSE-H) HORIZONTAL  
 EUT : GSM/GPRS Wireless Data Module  
 Model Name : SIM800H  
 Temp/Humi : 24°C / 49%  
 Power Rating: AC 120V/60Hz  
 Mode : 8DPSK Channel 78  
 Memo :

	ReadAntenna	Cable	Preamp	Limit	Over				
Freq	Level	Factor	Loss	Factor	Level	Line			
MHz	dBuV	dB/m	dB	dB	dBuV/m	dBuV/m			
1 pp	67.83	12.75	21.71	1.11	0.00	35.57	40.00	-4.43	Peak

**Above 1GHz:**

Bluetooth GFSK, traffic mode; Channel 0

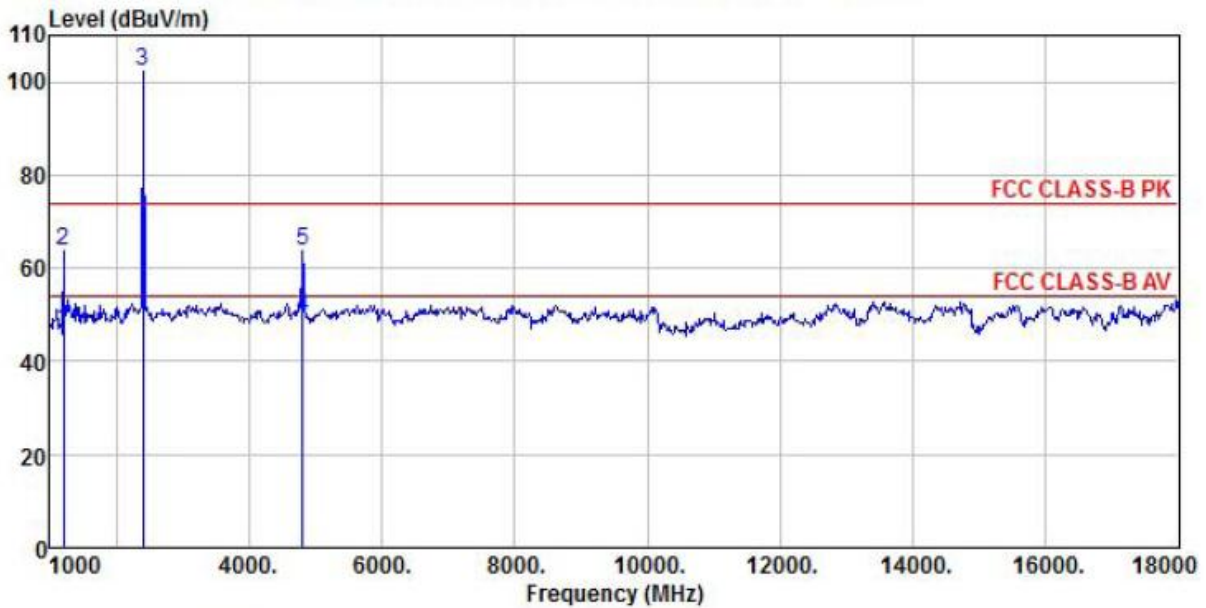

Site : chamber  
 Condition : FCC CLASS-B PK 3m BBHA9120D(RSE-V) VERTICAL  
 EUT : GSM/GPRS Wireless Data Module  
 Model Name : SIM800H  
 Temp/Humi : 24°C / 49%  
 Power Rating: AC 120V/60Hz  
 Mode : GFSK Channel 0  
 Memo :

	ReadAntenna	Cable	Preamp		Limit	Over		
Freq	Level	Factor	Loss	Factor	Level	Line	Limit	Remark
MHz	dBuV	dB/m	dB	dB	dBuV/m	dBuV/m	dB	
1	1201.00	44.04	36.12	5.03	38.42	46.77	54.00	-7.23 Average
2	1204.00	60.98	36.12	5.03	38.42	63.71	74.00	-10.29 Peak
3 pp	2394.00	95.67	37.92	7.13	38.34	102.38	74.00	28.38 Peak
4 av	4804.00	34.06	42.27	10.40	37.17	49.56	54.00	-4.44 Average
5	4808.00	48.30	42.27	10.40	37.17	63.80	74.00	-10.20 Peak

**Notes:** there is not any harmonic but for background noise above 6GHz.

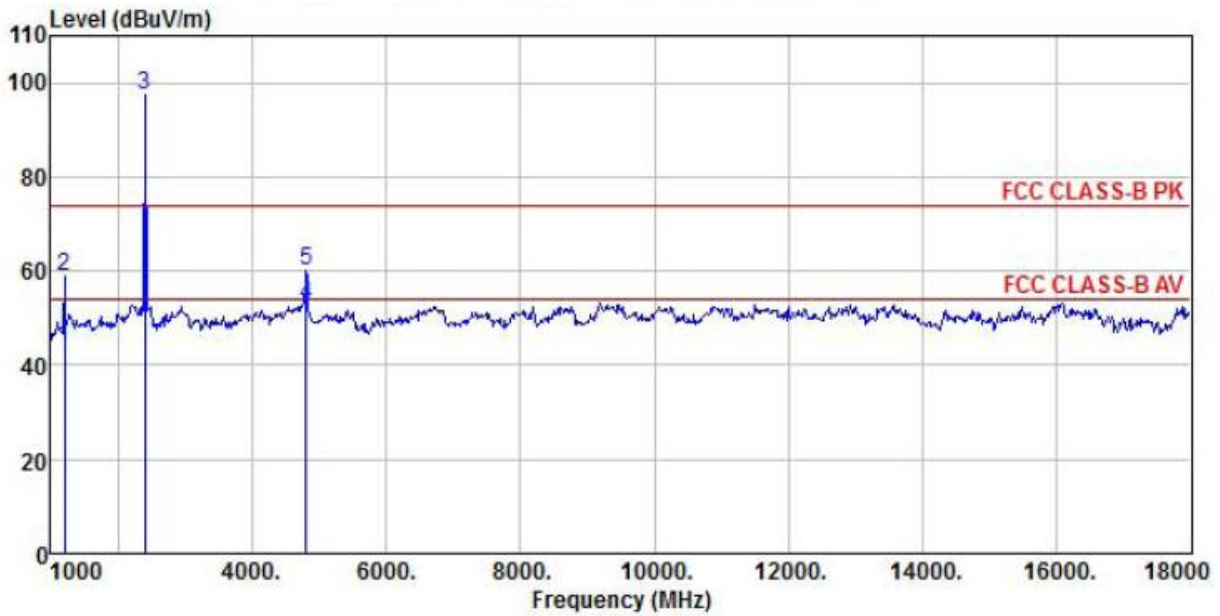

Site : chamber  
 Condition : FCC CLASS-B PK 3m BBHA9120D(RSE-H) HORIZONTAL  
 EUT : GSM/GPRS Wireless Data Module  
 Model Name : SIM800H  
 Temp/Humi : 24°C / 49%  
 Power Rating: AC 120V/60Hz  
 Mode : GFSK Channel 0  
 Memo :

	ReadAntenna	Cable	Preamp	Limit	Over			
Freq	Level	Factor	Loss	Factor	Level	Line	Limit	Remark
MHz	dBuV	dB/m	dB	dB	dBuV/m	dBuV/m	dB	
1	1201.00	40.94	36.12	5.03	38.42	43.67	54.00	-10.33 Average
2	1204.00	55.98	36.12	5.03	38.42	58.71	74.00	-15.29 Peak
3 pp	2394.00	90.84	37.92	7.13	38.34	97.55	74.00	23.55 Peak
4 av	4804.00	37.30	42.27	10.40	37.17	52.80	54.00	-1.20 Average
5	4808.00	44.77	42.27	10.40	37.17	60.27	74.00	-13.73 Peak

**Notes:** there is not any harmonic but for background noise above 6GHz.

Bluetooth GFSK, traffic mode; Channel 39

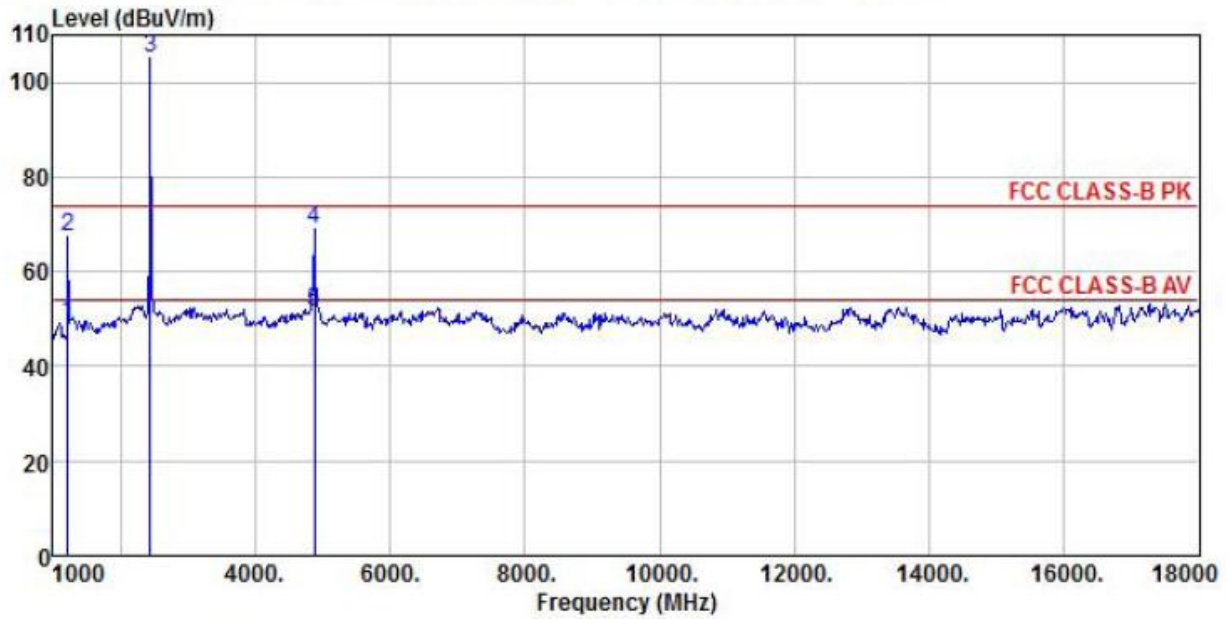

Site : chamber  
 Condition : FCC CLASS-B PK 3m BBHA9120D(RSE-V) VERTICAL  
 EUT : GSM/GPRS Wireless Data Module  
 Model Name : SIM800H  
 Temp/Humi : 24°C / 49%  
 Power Rating: AC 120V/60Hz  
 Mode : GFSK Channel 39  
 Memo :

	ReadAntenna	Cable	Preamp		Limit	Over		
Freq	Level	Factor	Loss	Factor	Level	Line	Limit	Remark
MHz	dBuV	dB/m	dB	dB	dBuV/m	dBuV/m	dB	
1	1220.00	45.40	37.19	5.05	38.42	49.22	54.00	-4.78 Average
2	1221.00	63.40	37.19	5.05	38.42	67.22	74.00	-6.78 Peak
3 pp	2445.00	97.66	38.25	7.37	38.32	104.96	74.00	30.96 Peak
4	4876.00	54.00	41.63	10.36	37.15	68.84	74.00	-5.16 Peak
5 av	4882.00	36.72	41.63	10.36	37.15	51.56	54.00	-2.44 Average

**Notes:** there is not any harmonic but for background noise above 6GHz.



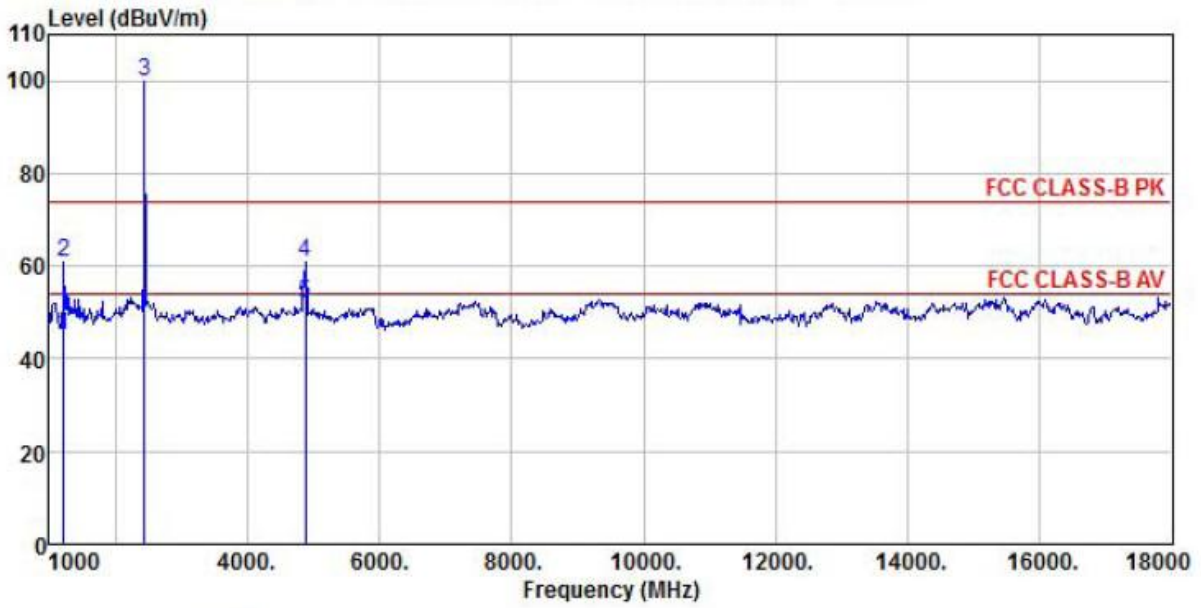

Site : chamber  
 Condition : FCC CLASS-B PK 3m BBHA9120D(RSE-H) HORIZONTAL  
 EUT : GSM/GPRS Wireless Data Module  
 Model Name : SIM800H  
 Temp/Humi : 24°C / 49%  
 Power Rating: AC 120V/60Hz  
 Mode : GFSK Channel 39  
 Memo :

	ReadAntenna	Cable	Preamp	Limit	Over			
Freq	Level	Factor	Loss	Factor	Level	Line	Limit	Remark
MHz	dBuV	dB/m	dB	dB	dBuV/m	dBuV/m	dB	
1	1220.00	41.39	37.19	5.05	38.42	45.21	54.00	-8.79 Average
2	1221.00	56.87	37.19	5.05	38.42	60.69	74.00	-13.31 Peak
3 pp	2445.00	92.41	38.25	7.37	38.32	99.71	74.00	25.71 Peak
4	4876.00	46.24	41.63	10.36	37.15	61.08	74.00	-12.92 Peak
5 av	4882.00	37.20	41.63	10.36	37.15	52.04	54.00	-1.96 Average

**Notes:** there is not any harmonic but for background noise above 6GHz.

Bluetooth GFSK, traffic mode; Channel 78

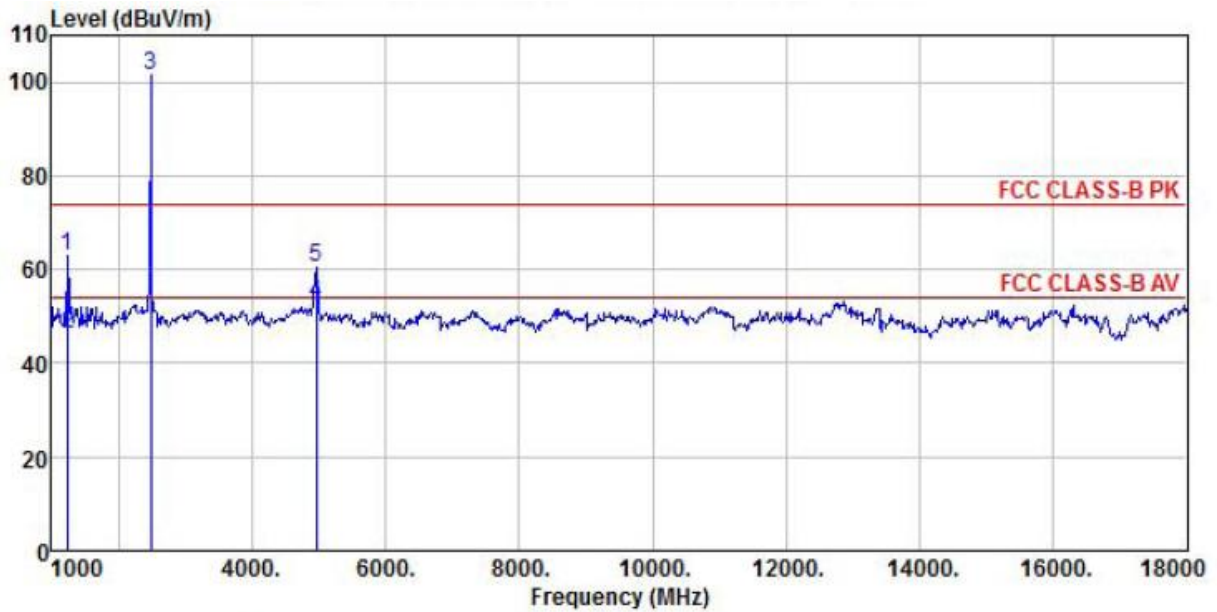

Site : chamber  
 Condition : FCC CLASS-B PK 3m BBHA9120D(RSE-V) VERTICAL  
 EUT : GSM/GPRS Wireless Data Module  
 Model Name : SIM800H  
 Temp/Humi : 24°C / 49%  
 Power Rating: AC 120V/60Hz  
 Mode : GFSK Channel 78  
 Memo :

	ReadAntenna	Cable	Preamp	Limit	Over			
Freq	Level	Factor	Loss	Factor	Level	Line	Limit	Remark
MHz	dBuV	dB/m	dB	dB	dBuV/m	dBuV/m	dB	
1	1238.00	57.88	38.25	5.07	38.42	62.78	74.00	-11.22 Peak
2	1240.00	41.55	38.25	5.07	38.42	46.45	54.00	-7.55 Average
3 pp	2479.00	94.20	38.38	7.41	38.31	101.68	74.00	27.68 Peak
4 av	4960.00	37.20	42.07	10.52	37.11	52.68	54.00	-1.32 Average
5	4961.00	45.09	42.07	10.52	37.11	60.57	74.00	-13.43 Peak

**Notes:** there is not any harmonic but for background noise above 6GHz.

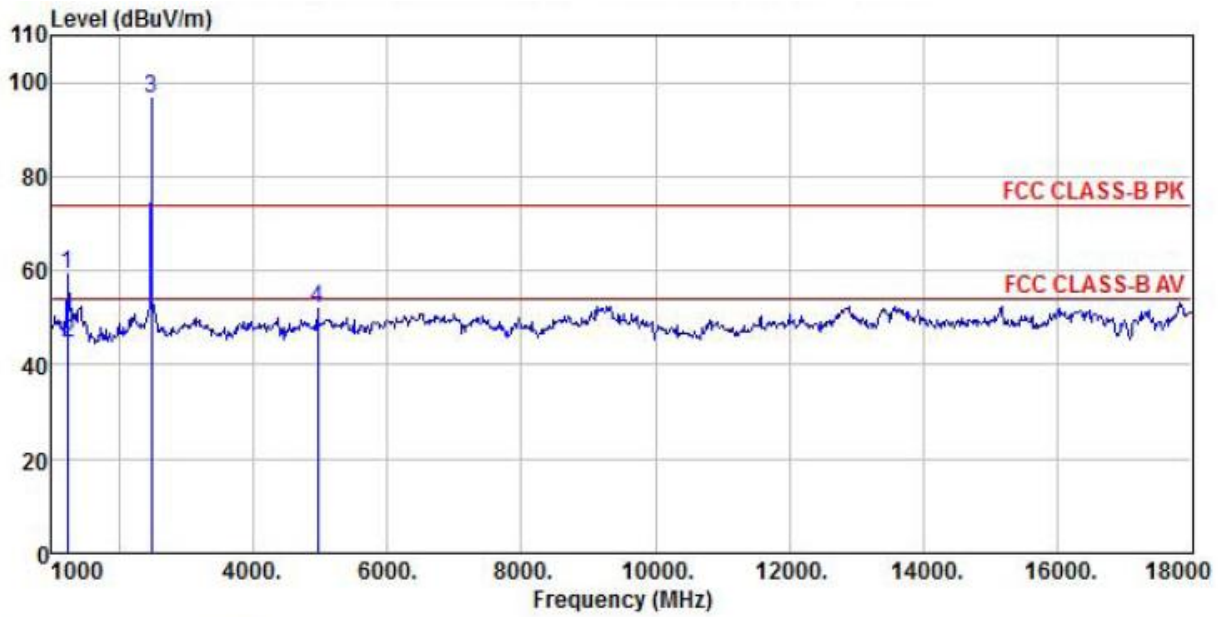

Site : chamber  
 Condition : FCC CLASS-B PK 3m BBHA9120D(RSE-H) HORIZONTAL  
 EUT : GSM/GPRS Wireless Data Module  
 Model Name : SIM800H  
 Temp/Humi : 24°C / 49%  
 Power Rating: AC 120V/60Hz  
 Mode : GFSK Channel 78  
 Memo :

	ReadAntenna	Cable	Preamp	Limit	Over			
Freq	Level	Factor	Loss	Factor	Level	Line	Limit	Remark
MHz	dBuV	dB/m	dB	dB	dBuV/m	dBuV/m	dB	
1	1238.00	54.39	38.25	5.07	38.42	59.29	74.00	-14.71 Peak
2 av	1240.00	39.70	38.25	5.07	38.42	44.60	54.00	-9.40 Average
3 pp	2479.00	89.18	38.38	7.41	38.31	96.66	74.00	22.66 Peak
4	4961.00	36.38	42.07	10.52	37.11	51.86	74.00	-22.14 Peak

**Notes:** there is not any harmonic but for background noise above 6GHz.

Bluetooth 8-DPSK, traffic mode; Channel 0

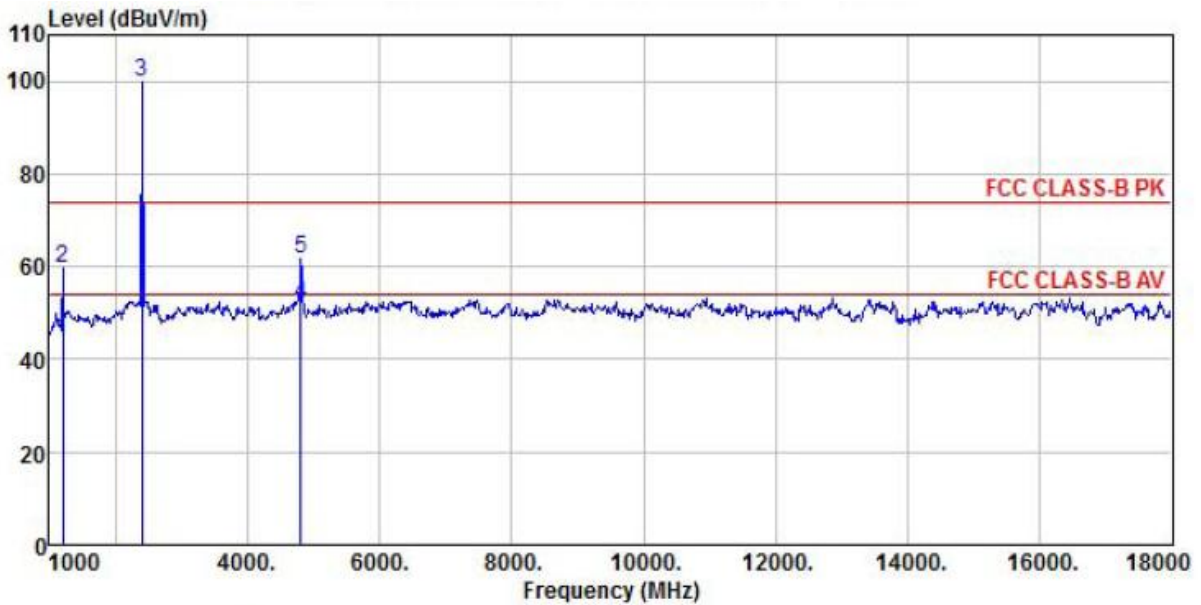

Site : chamber  
 Condition : FCC CLASS-B PK 3m BBHA9120D(RSE-V) VERTICAL  
 EUT : GSM/GPRS Wireless Data Module  
 Model Name : SIM800H  
 Temp/Humi : 24°C / 49%  
 Power Rating: AC 120V/60Hz  
 Mode : 8DPSK Channel 0  
 Memo :

	Freq	ReadAntenna	Cable	Preamp	Limit	Over		
	MHz	Level	Factor	Loss	Factor	Level	Line	Limit
		dBuV	dB/m	dB	dB	dBuV/m	dBuV/m	dB
1	1201.00	41.53	36.12	5.03	38.42	44.26	54.00	-9.74 Average
2	1204.00	56.73	36.12	5.03	38.42	59.46	74.00	-14.54 Peak
3 pp	2394.00	93.16	37.92	7.13	38.34	99.87	74.00	25.87 Peak
4 av	4804.00	36.46	42.27	10.40	37.17	51.96	54.00	-2.04 Average
5	4808.00	46.22	42.27	10.40	37.17	61.72	74.00	-12.28 Peak

**Notes:** there is not any harmonic but for background noise above 6GHz.

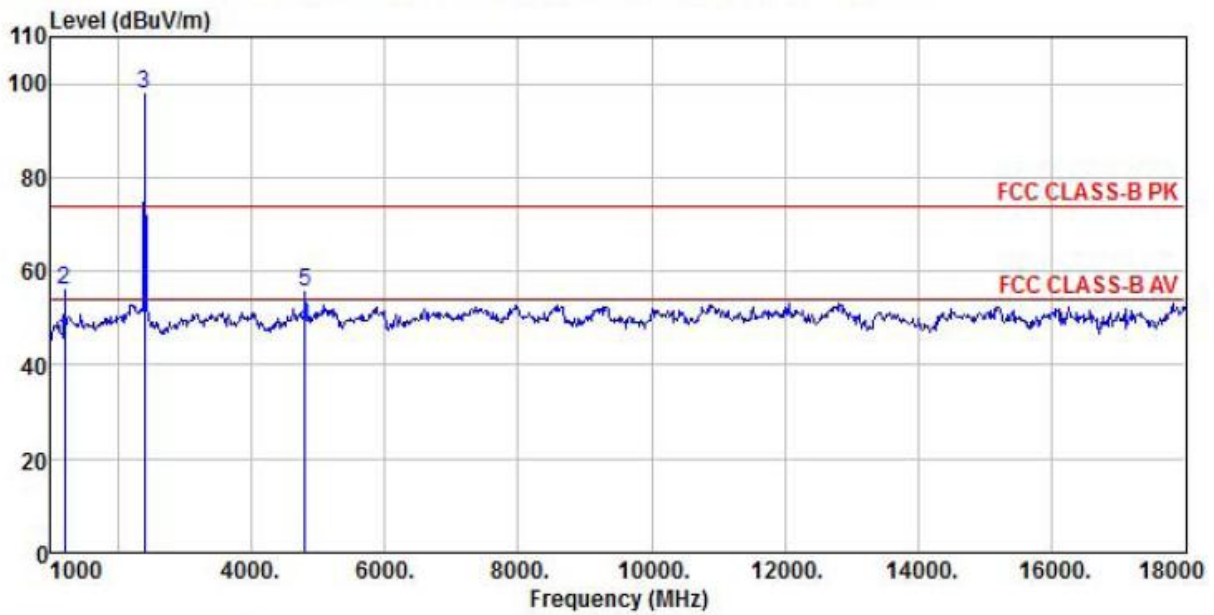

Site : chamber  
 Condition : FCC CLASS-B PK 3m BBHA9120D(RSE-H) HORIZONTAL  
 EUT : GSM/GPRS Wireless Data Module  
 Model Name : SIM800H  
 Temp/Humi : 24°C / 49%  
 Power Rating: AC 120V/60Hz  
 Mode : 8DPSK Channel 0  
 Memo :

	ReadAntenna	Cable	Preamp	Limit	Over			
Freq	Level	Factor	Loss	Factor	Level	Line	Limit	Remark
MHz	dBuV	dB/m	dB	dB	dBuV/m	dBuV/m	dB	
1	1201.00	42.73	36.12	5.03	38.42	45.46	54.00	-8.54 Average
2	1204.00	53.12	36.12	5.03	38.42	55.85	74.00	-18.15 Peak
3 pp	2394.00	90.97	37.92	7.13	38.34	97.68	74.00	23.68 Peak
4 av	4804.00	32.50	42.27	10.40	37.17	48.00	54.00	-6.00 Average
5	4808.00	40.05	42.27	10.40	37.17	55.55	74.00	-18.45 Peak

**Notes:** there is not any harmonic but for background noise above 6GHz.

Bluetooth 8-DPSK, traffic mode; Channel 39

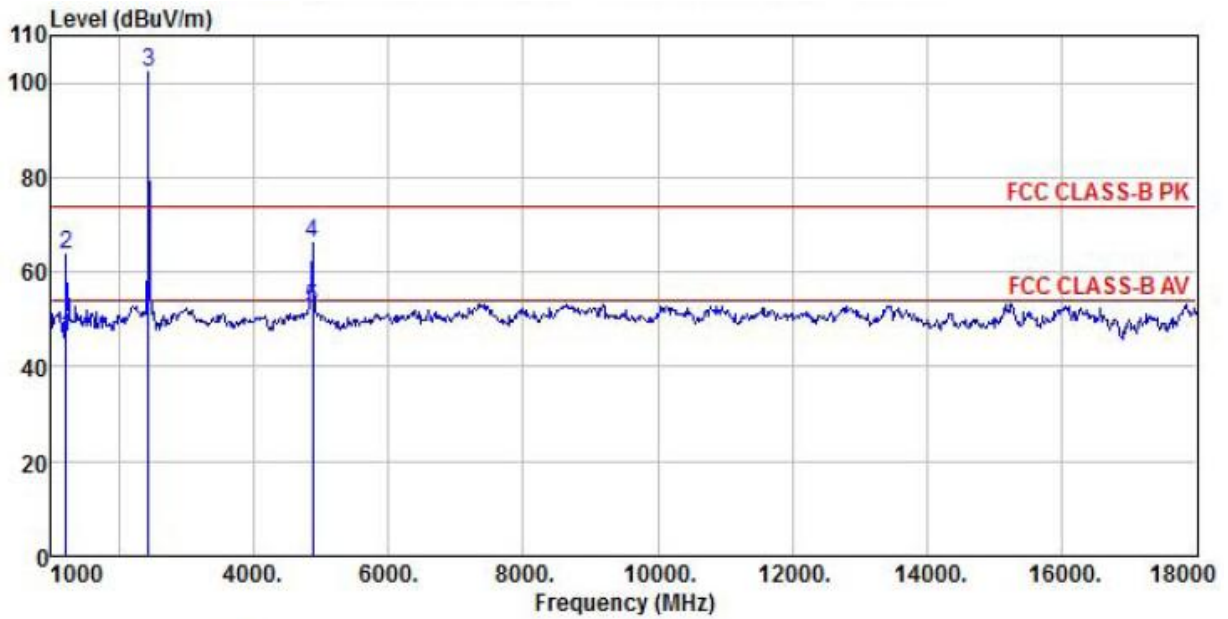

Site : chamber  
 Condition : FCC CLASS-B PK 3m BBHA9120D(RSE-V) VERTICAL  
 EUT : GSM/GPRS Wireless Data Module  
 Model Name : SIM800H  
 Temp/Humi : 24°C / 49%  
 Power Rating: AC 120V/60Hz  
 Mode : 8DPSK Channel 39  
 Memo :

	ReadAntenna	Cable	Preamp		Limit	Over			
Freq	Level	Factor	Loss	Factor	Level	Line	Limit	Remark	
MHz	dBuV	dB/m	dB	dB	dBuV/m	dBuV/m	dB		
1	1220.00	42.33	37.19	5.05	38.42	46.15	54.00	-7.85	Average
2	1221.00	59.75	37.19	5.05	38.42	63.57	74.00	-10.43	Peak
3 pp	2445.00	95.11	38.25	7.37	38.32	102.41	74.00	28.41	Peak
4	4876.00	51.20	41.63	10.36	37.15	66.04	74.00	-7.96	Peak
5 av	4882.00	37.48	41.63	10.36	37.15	52.32	54.00	-1.68	Average

**Notes:** there is not any harmonic but for background noise above 6GHz.

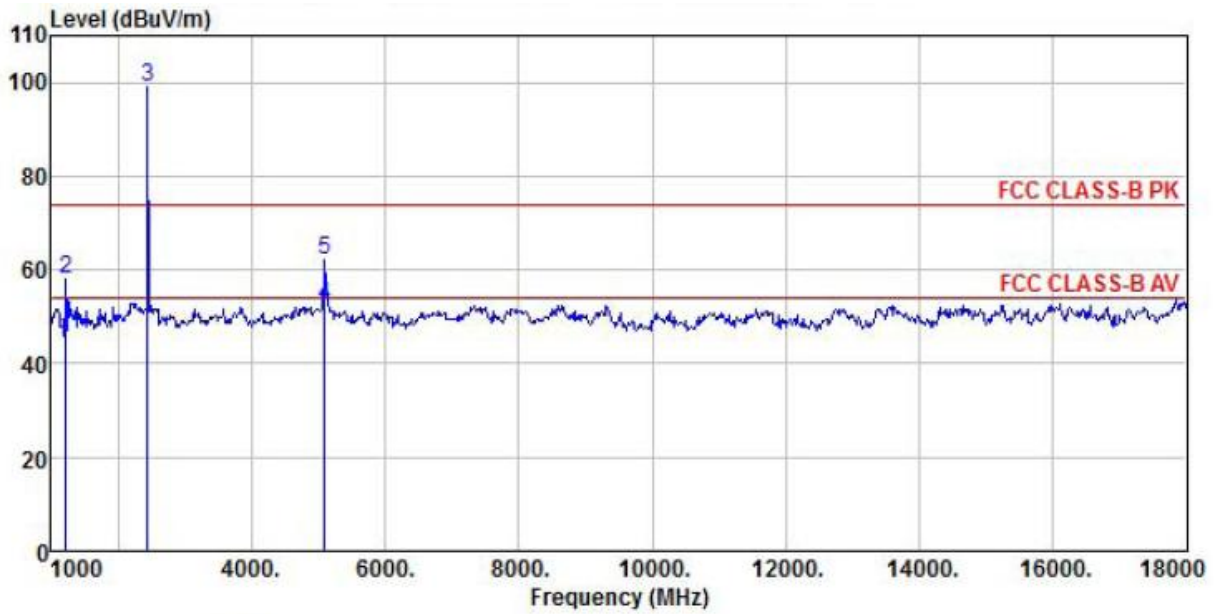

Site : chamber  
 Condition : FCC CLASS-B PK 3m BBHA9120D(RSE-H) HORIZONTAL  
 EUT : GSM/GPRS Wireless Data Module  
 Model Name : SIM800H  
 Temp/Humi : 24°C / 49%  
 Power Rating: AC 120V/60Hz  
 Mode : 8DPSK Channel 39  
 Memo :

	ReadAntenna	Cable	Preamp	Limit	Over			
Freq	Level	Factor	Loss	Factor	Level	Line	Limit	Remark
MHz	dBuV	dB/m	dB	dB	dBuV/m	dBuV/m	dB	
1	1220.00	41.79	37.19	5.05	38.42	45.61	54.00	-8.39 Average
2	1221.00	54.43	37.19	5.05	38.42	58.25	74.00	-15.75 Peak
3 pp	2445.00	91.72	38.25	7.37	38.32	99.02	74.00	25.02 Peak
4 av	5097.00	35.42	43.34	10.54	37.07	52.23	54.00	-1.77 Average
5	5097.00	45.11	43.34	10.54	37.07	61.92	74.00	-12.08 Peak

**Notes:** there is not any harmonic but for background noise above 6GHz.

Bluetooth 8-DPSK, traffic mode; Channel 78

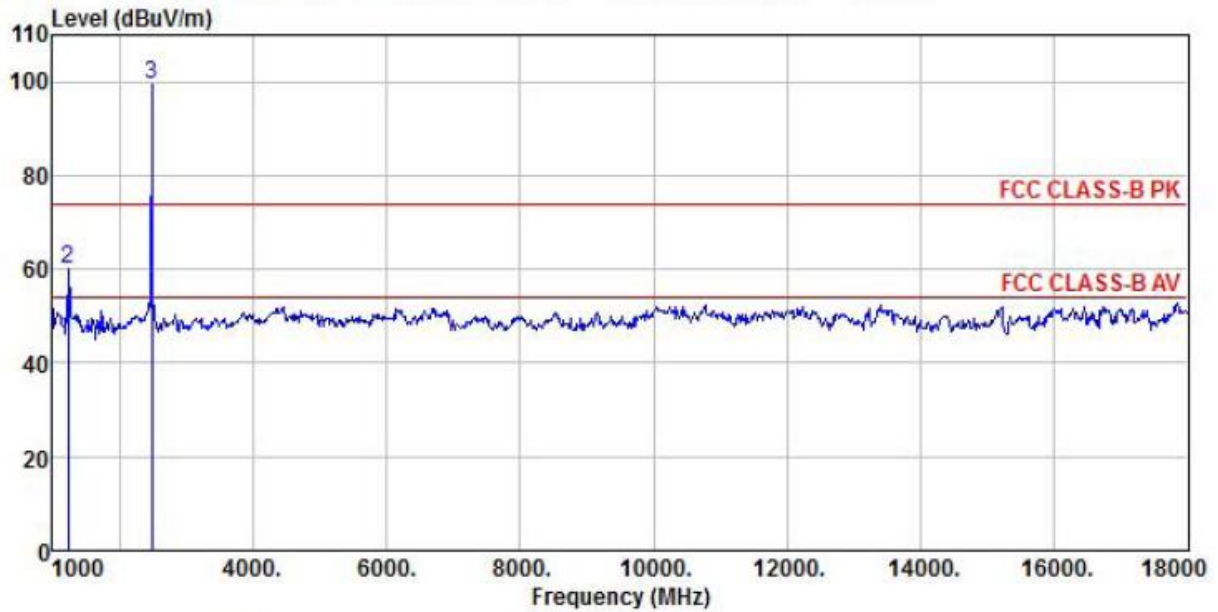

Site : chamber  
 Condition : FCC CLASS-B PK 3m BBHA9120D(RSE-V) VERTICAL  
 EUT : GSM/GPRS Wireless Data Module  
 Model Name : SIM800H  
 Temp/Humi : 24°C / 49%  
 Power Rating: AC 120V/60Hz  
 Mode : 8DPSK Channel 78  
 Memo :

	ReadAntenna	Cable	Preamp	Limit	Over			
Freq	Level	Factor	Loss	Factor	Level	Line	Limit	Remark
MHz	dBuV	dB/m	dB	dB	dBuV/m	dBuV/m	dB	
1 av	1238.00	40.64	38.25	5.07	38.42	45.54	54.00	-8.46 Average
2	1238.00	55.37	38.25	5.07	38.42	60.27	74.00	-13.73 Peak
3 pp	2479.00	92.02	38.38	7.41	38.31	99.50	74.00	25.50 Peak

**Notes:** there is not any harmonic but for background noise above 6GHz.



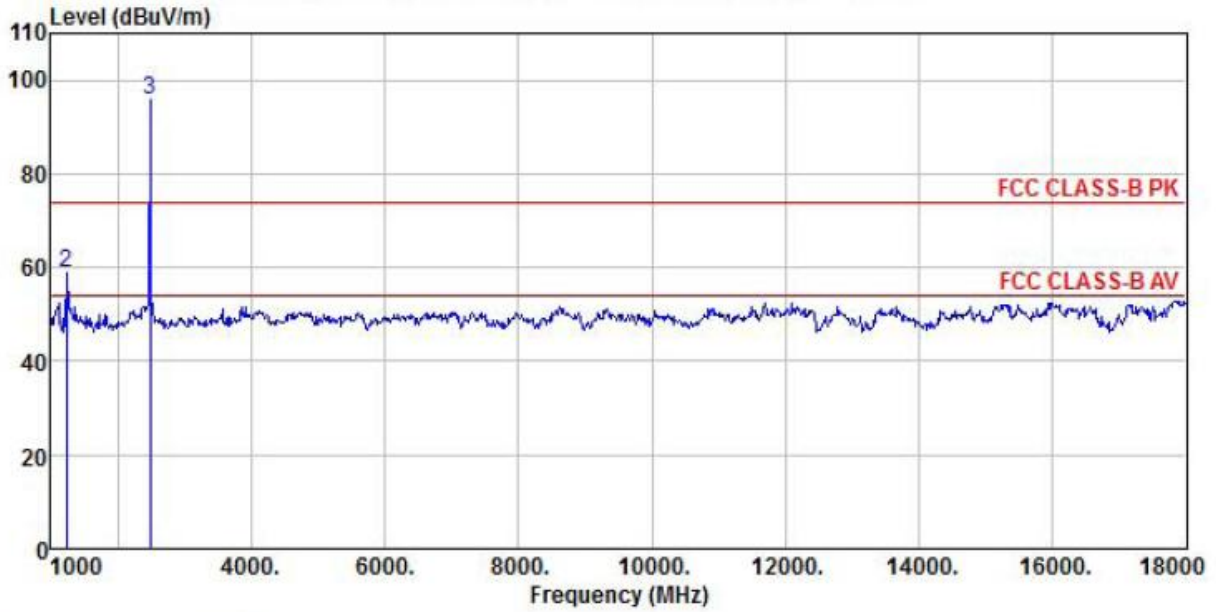

Site : chamber  
 Condition : FCC CLASS-B PK 3m BBHA9120D(RSE-H) HORIZONTAL  
 EUT : GSM/GPRS Wireless Data Module  
 Model Name : SIM800H  
 Temp/Humi : 24°C / 49%  
 Power Rating: AC 120V/60Hz  
 Mode : 8DPSK Channel 78  
 Memo :

	ReadAntenna	Cable	Preamp	Limit	Over				
Freq	Level	Factor	Loss	Factor	Level	Line			
MHz	dBuV	dB/m	dB	dB	dBuV/m	dBuV/m			
1 av	1238.00	39.40	38.25	5.07	38.42	44.30	54.00	-9.70	Average
2	1238.00	53.76	38.25	5.07	38.42	58.66	74.00	-15.34	Peak
3 pp	2479.00	88.30	38.38	7.41	38.31	95.78	74.00	21.78	Peak

**Notes:** there is not any harmonic but for background noise above 6GHz.

## 12. AC POWER LINE CONDUCTED EMISSIONS

### 12.1 TEST SETUP

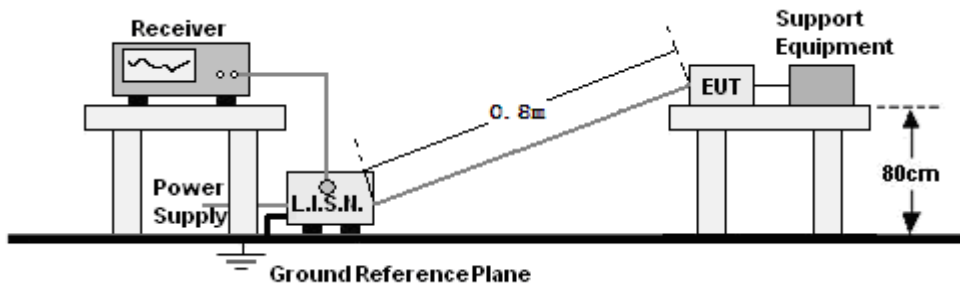

### 12.2 LIMITS

Frequency range (MHz)	Limits dB(μV)	
	Quasi-peak	Average
0,15 to 0,50	66 to 56	56 to 46
0,50 to 5	56	46
5 to 30	60	50

- NOTE:**
1. The lower limit shall apply at the transition frequencies.
  2. The limit decreases linearly with the logarithm of the frequency in the range 0.15 to 0.50 MHz.

### 12.3 TEST PROCEDURE

According to description of ANSI C63.4: 2009 sec.13.3, the AC power line preliminary conducted emissions measurements were carried out. The preliminary conducted measurements were performed using the spectrum analyzer to observe the emission characteristics of the EUT. The EUT configuration, cable configuration and mode of operation were determined for producing the maximum level of emissions. These configurations were used for final AC power line conducted emissions measurements. The EUT is placed on a non-metallic table 0.8m above the horizontal metal reference ground plane. The EUT is connected to LISN and LISN is connected to the reference ground. All other supplemental devices are connected with EUT through other LISN. The distance between EUT and LISN is 80cm. A radio link is established between EUT and the tester. The output power of the EUT is controlled by the tester and driven to maximum value. An initial pre-scan was performed on the live L line and neutral line with peak detector (9kHz RBW ). Both average detector and quasi-peak detector are performed at the frequencies with maximized peak emission. Conducted emissions were investigated over the frequency range from 0.15MHz to 30MHz using a receiver bandwidth of 9kHz.

## 12.4 RESULTS & PERFORMANCE

### GFSK BT

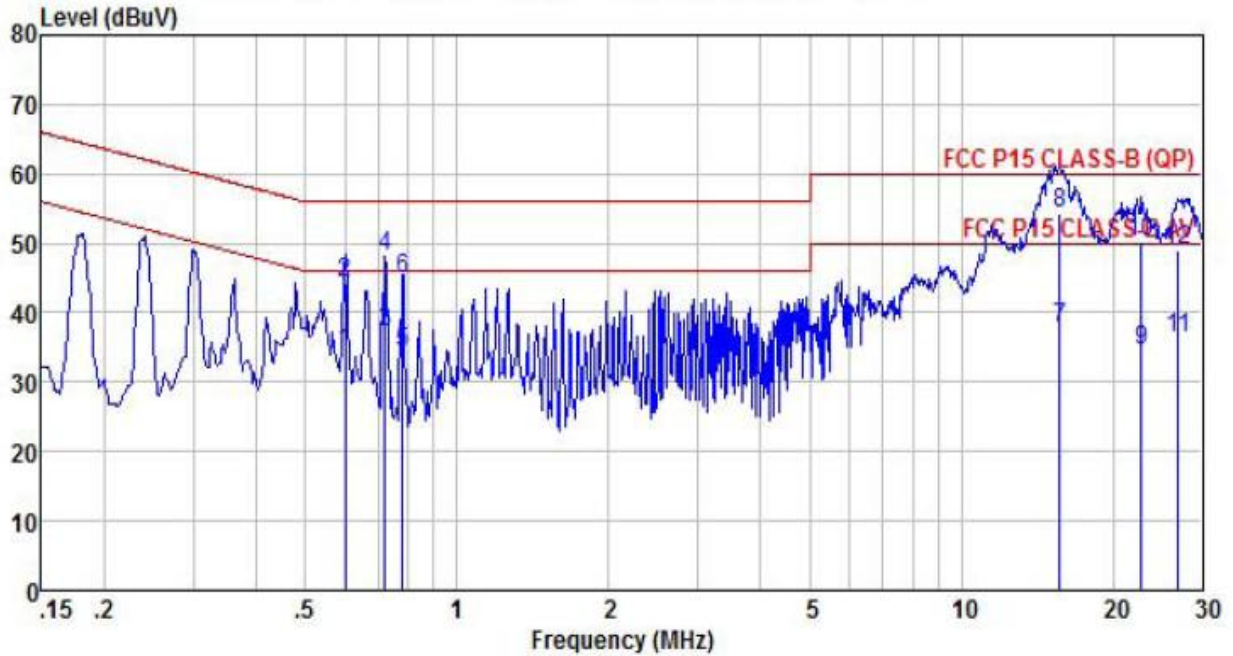

Site : chamber  
 Condition : FCC P15 CLASS-B (QP) ENV216(L)-20120730 LINE  
 EUT : GSM/GPRS Wireless Data Module  
 Model Name : SIM800H  
 Temp/Humi : 24°C / 49%  
 Power Rating: AC 120V/60Hz  
 Mode : BT GFSK  
 Memo :

	Read Freq	LISN Level	LISN Factor	Cable Loss	Preamp Factor	Level	Limit Line	Over Limit	Remark
	MHz	dBuV	dB	dB	dB	dBuV	dBuV	dB	
1	0.60	23.56	10.47	0.11	0.00	34.14	46.00	-11.86	Average
2	0.60	33.83	10.47	0.11	0.00	44.41	56.00	-11.59	QP
3 av	0.72	26.79	10.39	0.12	0.00	37.30	46.00	-8.70	Average
4	0.72	37.46	10.39	0.12	0.00	47.97	56.00	-8.03	QP
5	0.78	23.72	10.43	0.13	0.00	34.28	46.00	-11.72	Average
6	0.78	34.20	10.43	0.13	0.00	44.76	56.00	-11.24	QP
7	15.65	27.18	10.52	0.11	0.00	37.81	50.00	-12.19	Average
8 pp	15.65	43.55	10.52	0.11	0.00	54.18	60.00	-5.82	QP
9	22.77	23.83	10.50	0.11	0.00	34.44	50.00	-15.56	Average
10	22.77	39.54	10.50	0.11	0.00	50.15	60.00	-9.85	QP
11	26.98	25.71	10.48	0.12	0.00	36.31	50.00	-13.69	Average
12	26.98	38.49	10.48	0.12	0.00	49.09	60.00	-10.91	QP

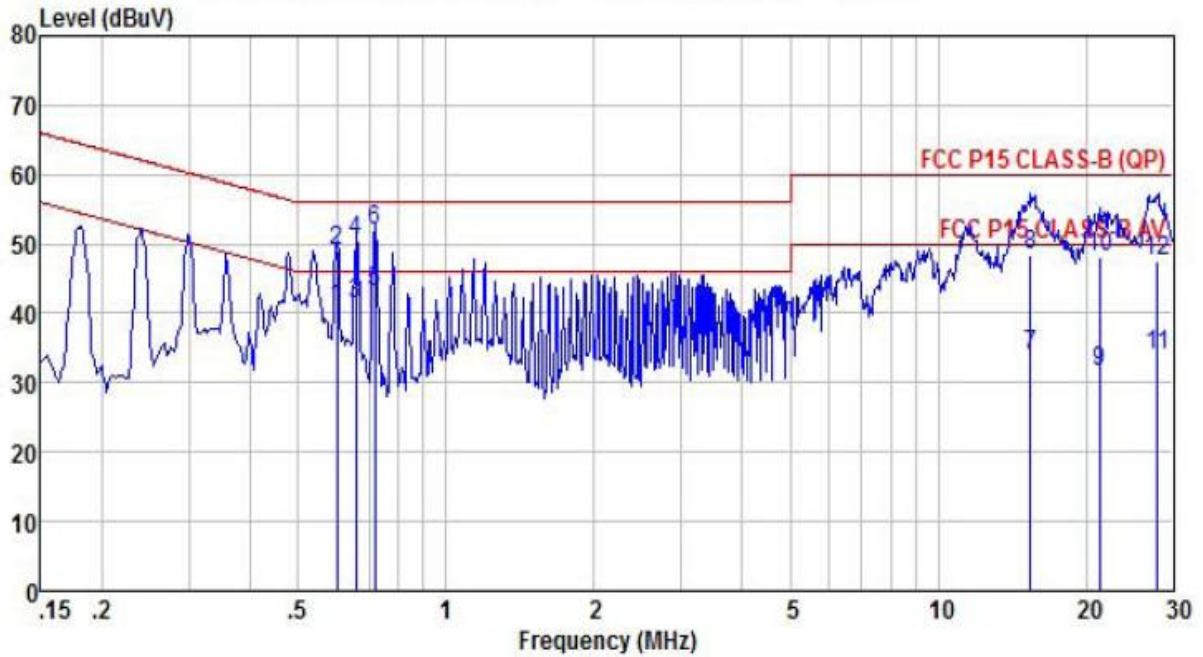

Site : chamber  
 Condition : FCC P15 CLASS-B (QP) ENV216(N)-20120730 NEUTRAL  
 EUT : GSM/GPRS Wireless Data Module  
 Model Name : SIM800H  
 Temp/Humi : 24°C / 49%  
 Power Rating: AC 120V/60Hz  
 Mode : BT GFSK  
 Memo :

	Read Freq	LISN Level	LISN Factor	Cable Loss	Preamp Factor	Level	Limit Line	Over Limit	Remark
	MHz	dBuV	dB	dB	dB	dBuV	dBuV	dB	
1	0.60	30.20	10.35	0.11	0.00	40.66	46.00	-5.34	Average
2	0.60	38.57	10.35	0.11	0.00	49.03	56.00	-6.97	QP
3	0.66	30.99	10.32	0.12	0.00	41.43	46.00	-4.57	Average
4	0.66	40.11	10.32	0.12	0.00	50.55	56.00	-5.45	QP
5 pp	0.72	32.78	10.30	0.12	0.00	43.20	46.00	-2.80	Average
6 qp	0.72	41.41	10.30	0.12	0.00	51.83	56.00	-4.17	QP
7	15.39	23.17	10.55	0.10	0.00	33.82	50.00	-16.18	Average
8	15.39	37.91	10.55	0.10	0.00	48.56	60.00	-11.44	QP
9	21.26	21.19	10.41	0.11	0.00	31.71	50.00	-18.29	Average
10	21.26	37.52	10.41	0.11	0.00	48.04	60.00	-11.96	QP
11	27.95	23.25	10.53	0.12	0.00	33.90	50.00	-16.10	Average
12	27.95	36.76	10.53	0.12	0.00	47.41	60.00	-12.59	QP

**8-DPSK BT**

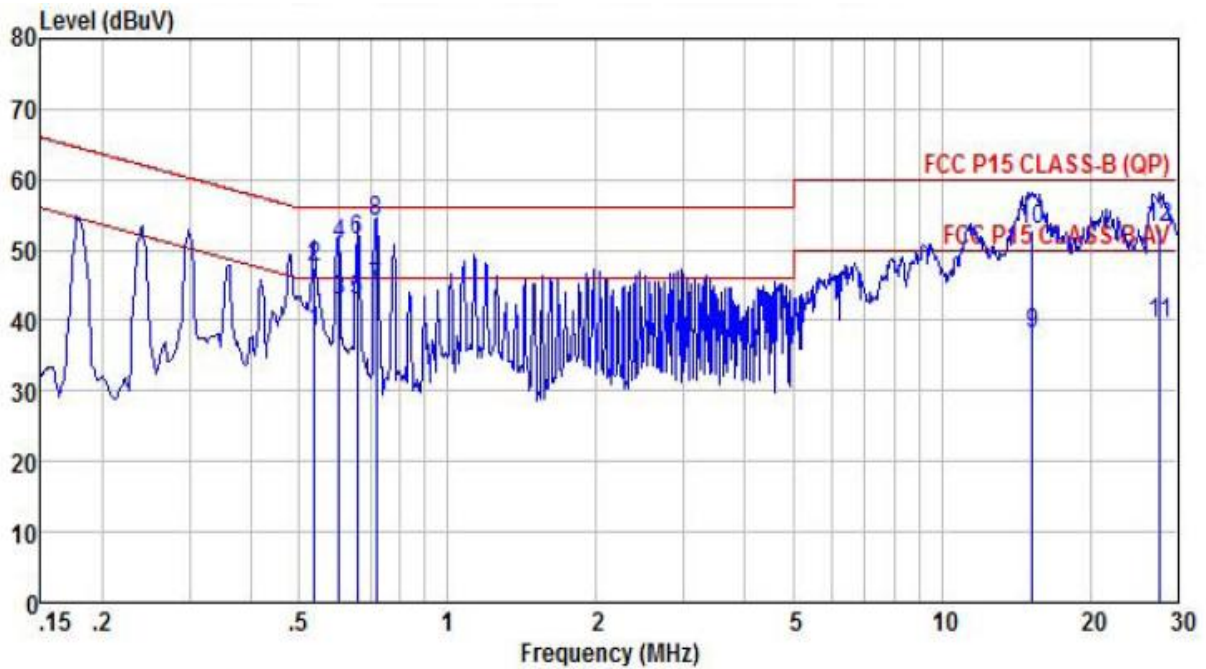

Site : chamber  
 Condition : FCC P15 CLASS-B (QP) ENV216(N)-20120730 NEUTRAL  
 EUT : GSM/GPRS Wireless Data Module  
 Model Name : SIM800H  
 Temp/Humi : 24°C / 49%  
 Power Rating: AC 120V/60Hz  
 Mode : BT 8DPSK  
 Memo :

	Read Freq	Level	LISN Factor	Cable Loss	Preamp Factor	Level	Limit Line	Over Limit	Remark
	MHz	dBuV	dB	dB	dB	dBuV	dBuV	dB	
1	0.54	27.86	10.39	0.11	0.00	38.36	46.00	-7.64	Average
2	0.54	37.15	10.39	0.11	0.00	47.65	56.00	-8.35	QP
3	0.60	32.25	10.35	0.11	0.00	42.71	46.00	-3.29	Average
4	0.60	40.37	10.35	0.11	0.00	50.83	56.00	-5.17	QP
5	0.66	32.28	10.32	0.12	0.00	42.72	46.00	-3.28	Average
6	0.66	41.04	10.32	0.12	0.00	51.48	56.00	-4.52	QP
7 pp	0.72	34.28	10.30	0.12	0.00	44.70	46.00	-1.30	Average
8 qp	0.72	43.51	10.30	0.12	0.00	53.93	56.00	-2.07	QP
9	15.23	27.38	10.56	0.10	0.00	38.04	50.00	-11.96	Average
10	15.23	42.16	10.56	0.10	0.00	52.82	60.00	-7.18	QP
11	27.71	28.91	10.53	0.12	0.00	39.56	50.00	-10.44	Average
12	27.71	42.57	10.53	0.12	0.00	53.22	60.00	-6.78	QP

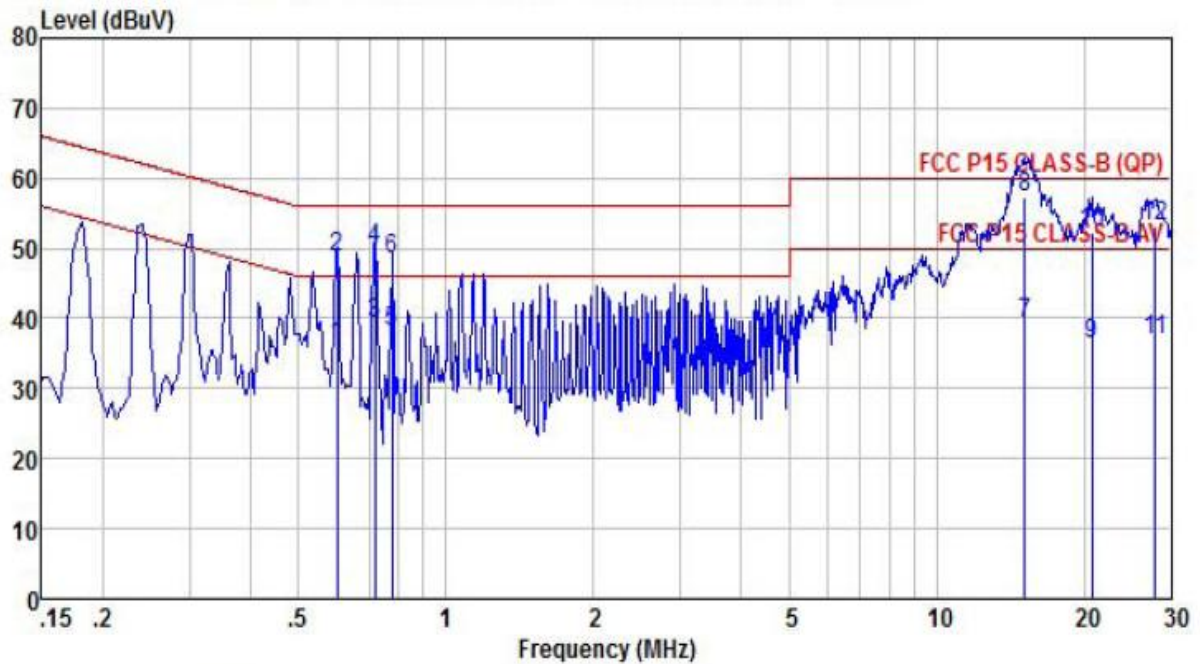

Site : chamber  
 Condition : FCC P15 CLASS-B (QP) ENV216(L)-20120730 LINE  
 EUT : GSM/GPRS Wireless Data Module  
 Model Name : SIM800H  
 Temp/Humi : 24°C / 49%  
 Power Rating: AC 120V/60Hz  
 Mode : BT 8DPSK  
 Memo :

	Read Freq	Level	LISN Factor	Cable Loss	Preamp Factor	Level	Limit Line	Over Limit	Remark
	MHz	dBuV	dB	dB	dB	dBuV	dBuV	dB	
1	0.60	25.43	10.47	0.11	0.00	36.01	46.00	-9.99	Average
2	0.60	38.19	10.47	0.11	0.00	48.77	56.00	-7.23	QP
3 av	0.72	28.82	10.39	0.12	0.00	39.33	46.00	-6.67	Average
4	0.72	39.47	10.39	0.12	0.00	49.98	56.00	-6.02	QP
5	0.78	27.64	10.42	0.13	0.00	38.19	46.00	-7.81	Average
6	0.78	37.81	10.42	0.13	0.00	48.36	56.00	-7.64	QP
7	15.15	28.52	10.52	0.10	0.00	39.14	50.00	-10.86	Average
8 pp	15.15	46.64	10.52	0.10	0.00	57.26	60.00	-2.74	QP
9	20.71	25.75	10.52	0.10	0.00	36.37	50.00	-13.63	Average
10	20.71	41.58	10.52	0.10	0.00	52.20	60.00	-7.80	QP
11	27.85	26.22	10.48	0.12	0.00	36.82	50.00	-13.18	Average
12	27.85	42.41	10.48	0.12	0.00	53.01	60.00	-6.99	QP

### APPENDIX 1 PHOTOGRAPHS OF TEST SETUP

Minimum hopping channels, Channel separation, Occupied bandwidth, Dwell time, Peak output power, Spurious emission(conducted) Test Setup Photos

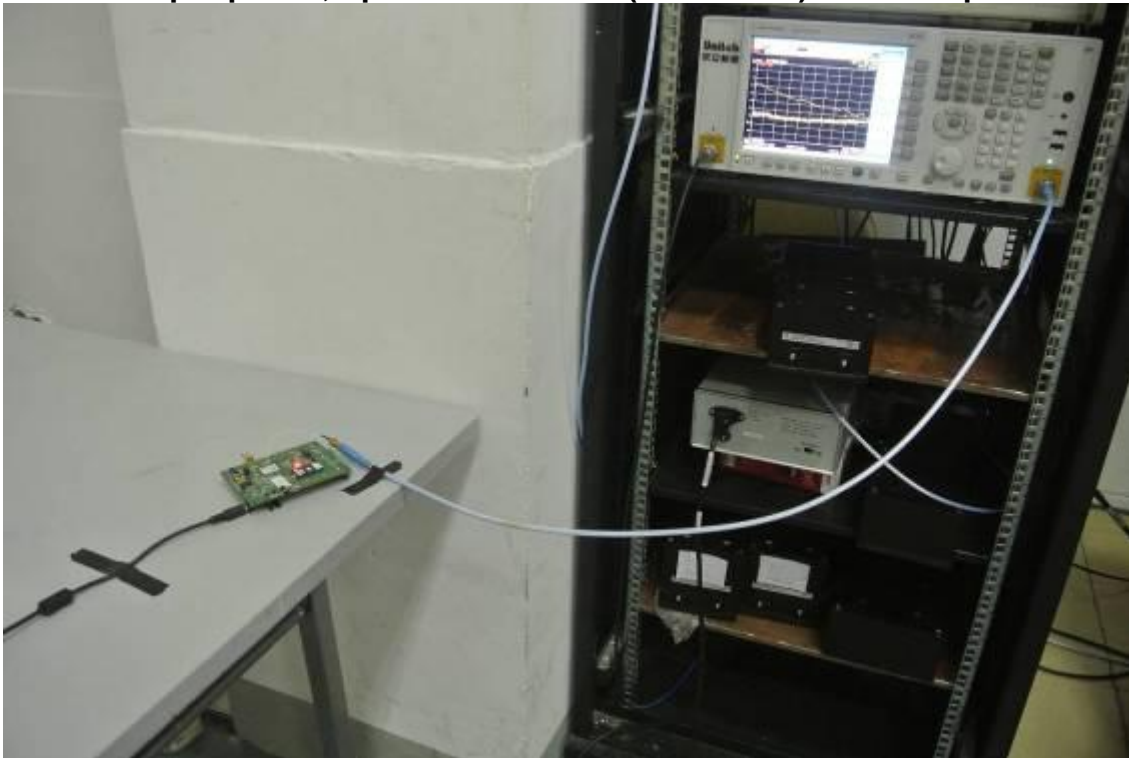

### Spurious Emissions Test Setup Photos

Description: Radiated Spurious Measurement Setup (From 9KHz to 30MHz)

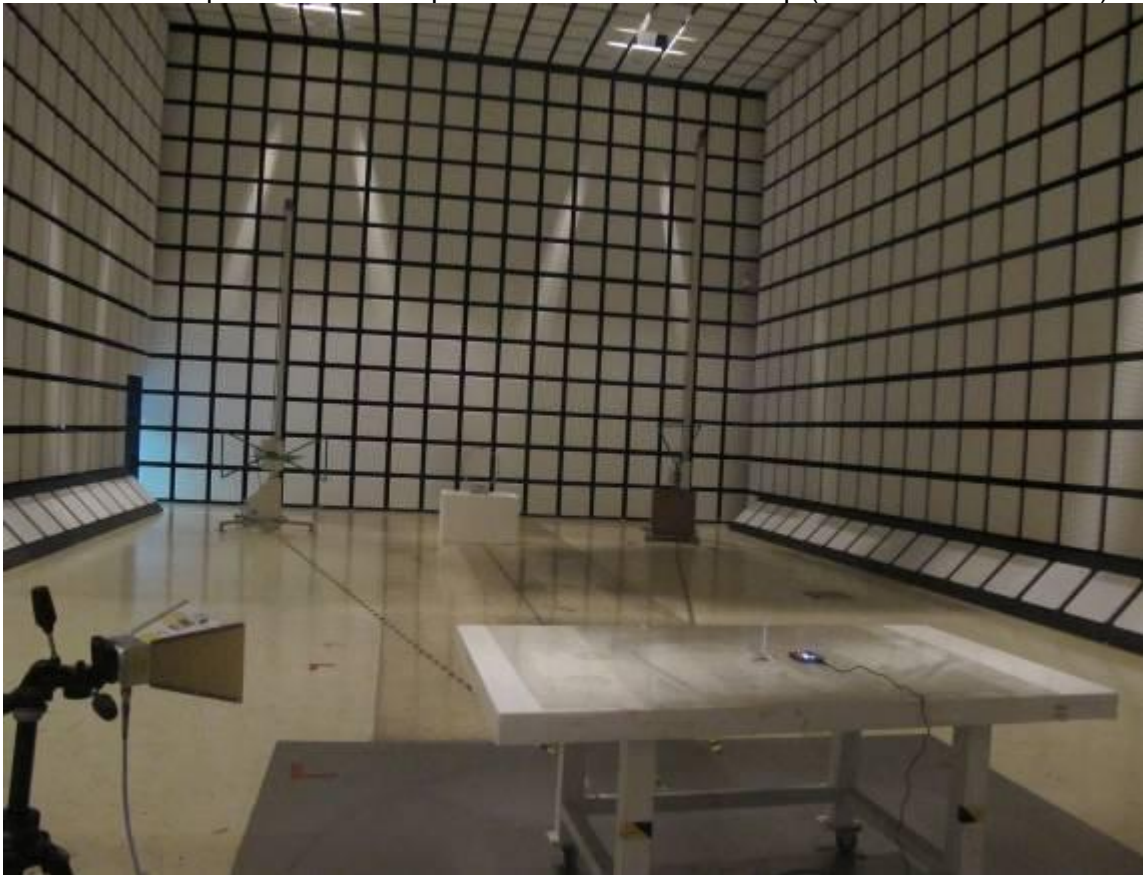

Description: Radiated Spurious Measurement Setup (From 30MHz to 1GHz)





Description: Radiated Spurious Measurement Setup (Above 1GHz)



AC power line conducted emission Test Setup Photos



## APPENDIX 2 PHOTOGRAPHS OF EUT

View of EUT-1



View of EUT-2



View of EUT-3



View of EUT-4



View of EUT-5



View of EUT-6

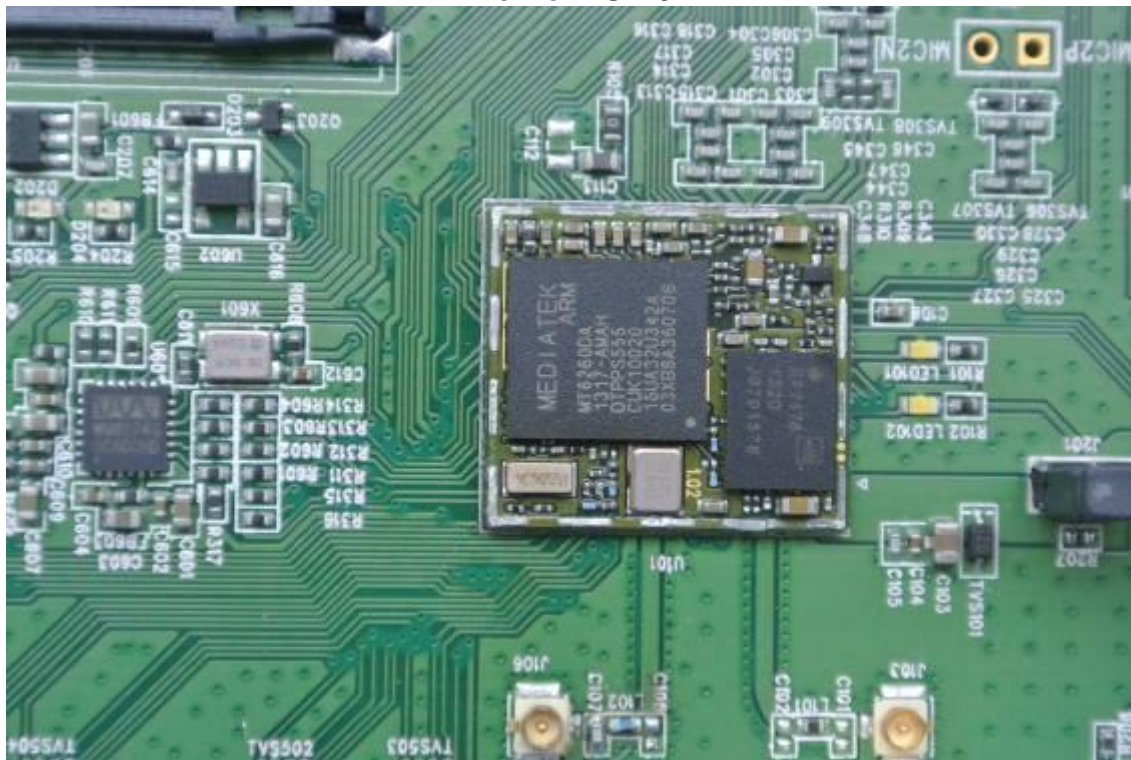

----End of the report----