



## GaAs MMIC I/Q UPCONVERTER 16 - 21 GHz

### Typical Applications

The HMC710LC5 is ideal for:

- Point-to-Point and Point-to-Multi-Point Radio
- Military Radar, EW & ELINT
- Satellite Communications
- Sensors

### Features

- High Conversion Gain: 12 dB
- Sideband Rejection: -20 dBc
- 2 LO to RF Isolation: 12 dB
- Output IP3: +30 dBm
- 32 Lead 5x5mm SMT Package: 25mm<sup>2</sup>

### Functional Diagram

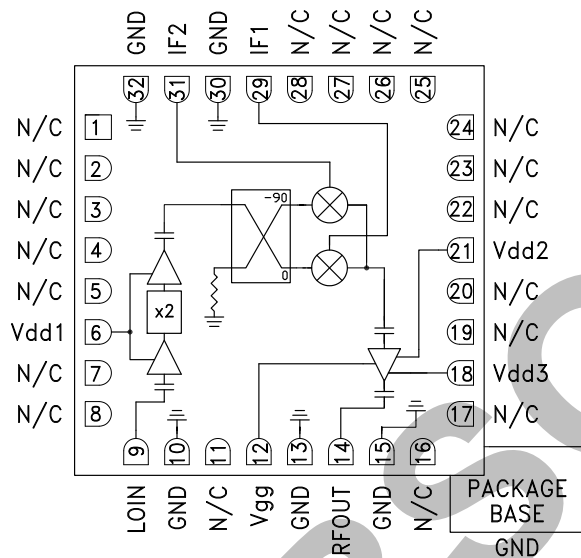

### General Description

The HMC710LC5 is a compact GaAs MMIC I/Q upconverter in a leadless RoHS compliant SMT package. This device provides a small signal conversion gain of 12 dB with -20 dBc of sideband rejection. The HMC710LC5 utilizes a driver amplifier preceded by an I/Q mixer where the LO is driven by an active x2 multiplier. IF1 and IF2 mixer inputs are provided and an external 90° hybrid is needed to select the required sideband. The I/Q mixer topology reduces the need for filtering of the unwanted sideband. The HMC710LC5 is a much smaller alternative to hybrid style single sideband upconverter assemblies and it eliminates the need for wire bonding by allowing the use of surface mount manufacturing techniques.

### Electrical Specifications,

$T_A = +25\text{ }^\circ\text{C}$ ,  $IF = 1000\text{ MHz}$ ,  $LO = +6\text{ dBm}$ ,  $Vdd1, 2, 3 = +5V$ ,  $Idd2 + Idd3 = 150\text{ mA}$  [1][3]

Parameter	Min.	Typ.	Max.	Units
Frequency Range, RF		16 - 21		GHz
Frequency Range, LO		7.5 - 11		GHz
Frequency Range, IF		DC - 3.5		GHz
Conversion Gain	7	12		dB
Sideband Rejection	-12	-20		dBc
1 dB Compression (Output)		20		dBm
2 LO to RF Isolation		12		dB
2 LO to IF Isolation [2]		20		dB
IP3 (Output)		30		dBm
Supply Current Idd1	52	90	108	mA
Supply Current Idd2	24	30		mA
Supply Current Idd3	96	120		mA

[1] Unless otherwise noted all measurements performed with high side LO, IF = 1000 MHz and external 90° IF hybrid.

[2] Data taken without external IF hybrid.

[3] Adjust Vgg between -2 to 0V to achieve Idd2 + Idd3 = 150 mA Typical.



**GaAs MMIC I/Q UPCONVERTER  
16 - 21 GHz**

*Data Taken as SSB Upconverter with External IF Hybrid*

**Conversion Gain vs. Temperature**

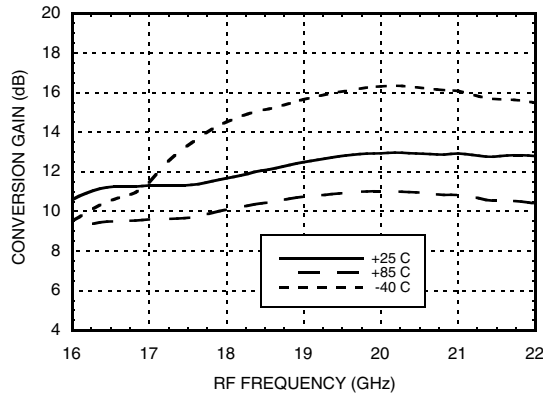

**Conversion Gain vs. LO Drive**

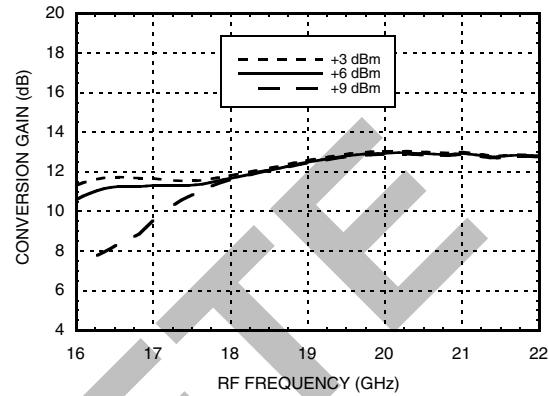

**Conversion Gain vs. IF Frequency**

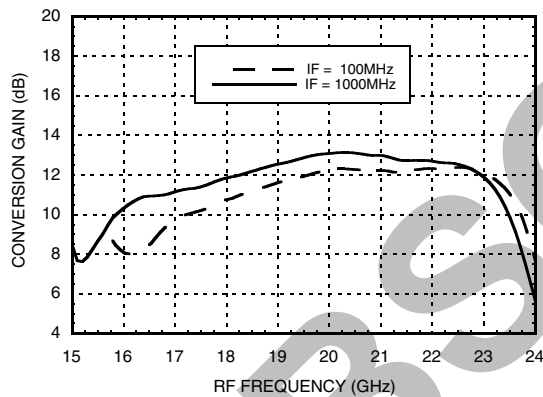

**Conversion Gain vs. Idd2 + Idd3**

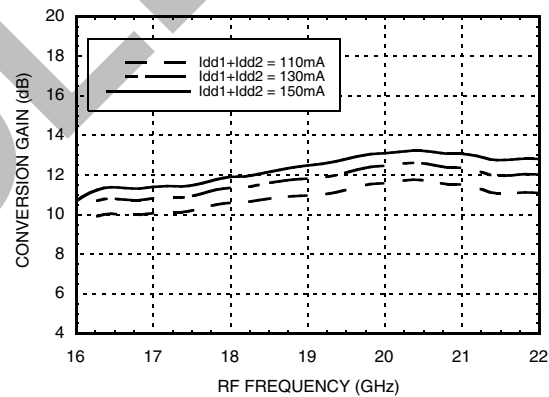

**RF, LO Return Loss**

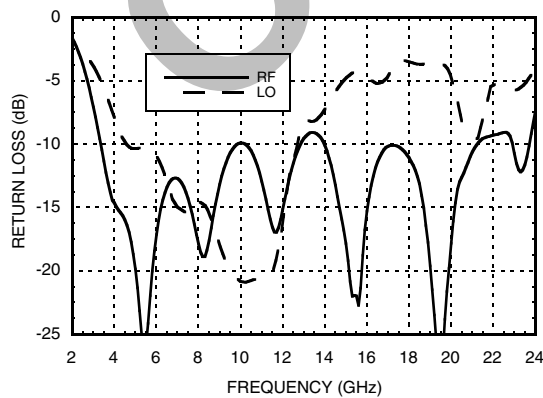

**IF Return Loss [1]**

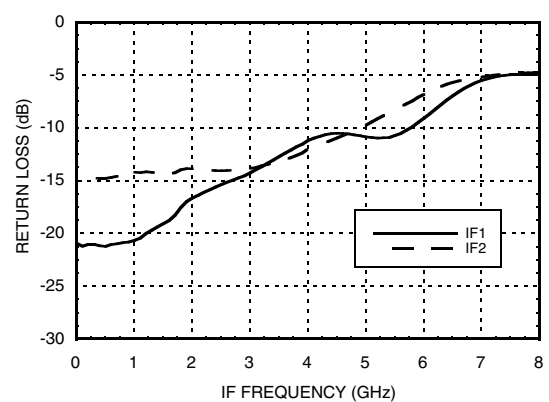

[1] Data taken without external IF hybrid



**GaAs MMIC I/Q UPCONVERTER  
16 - 21 GHz**

*Data Taken as SSB Upconverter with External IF Hybrid*

**Side Band Rejection**

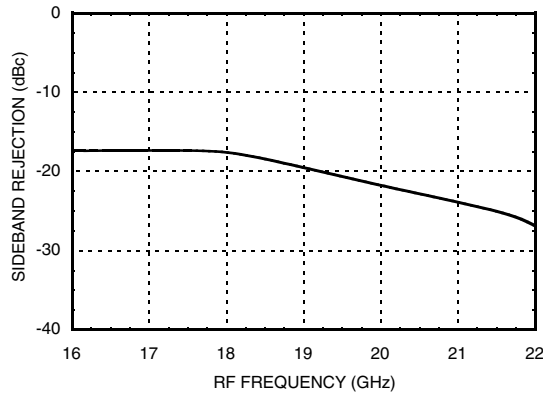

**Output P1dB vs. Temperature**

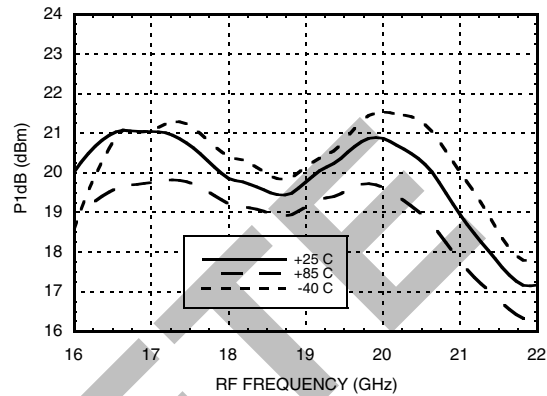

**Output IP3 vs. Temperature**

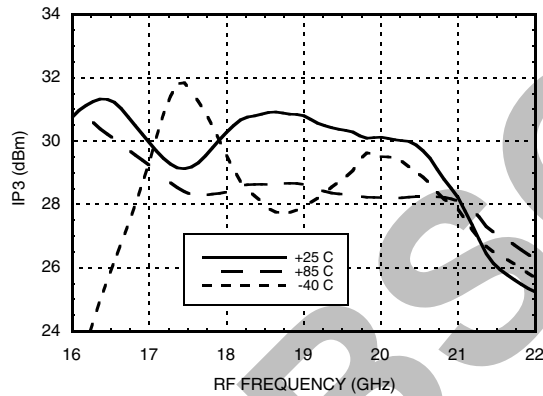

**Output IP3 vs. LO Drive**

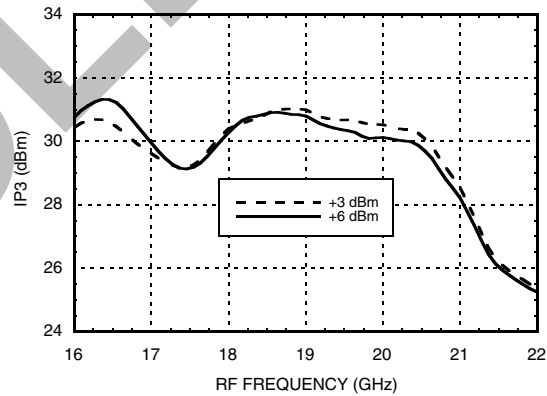

**Output IP3 vs. IF Frequency**

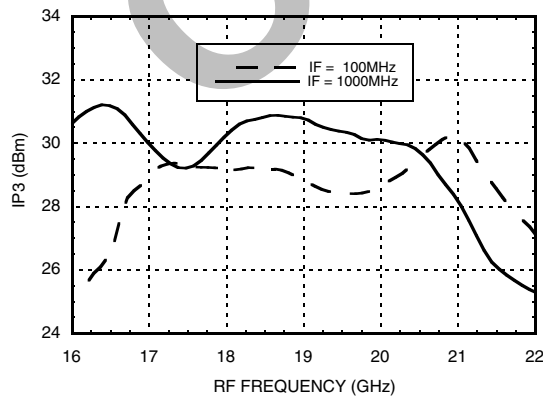

**Output IP3 vs. Idd2 + Idd3**

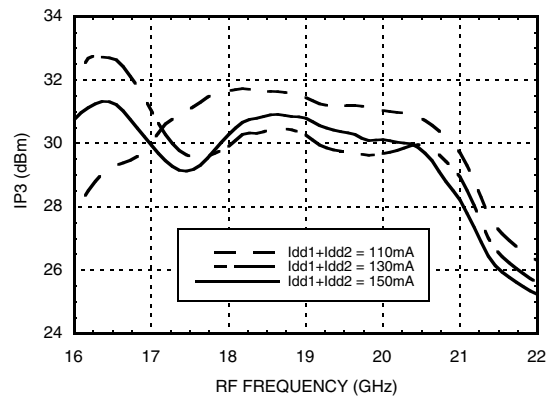



## GaAs MMIC I/Q UPCONVERTER 16 - 21 GHz

Isolations with 2LO [1]

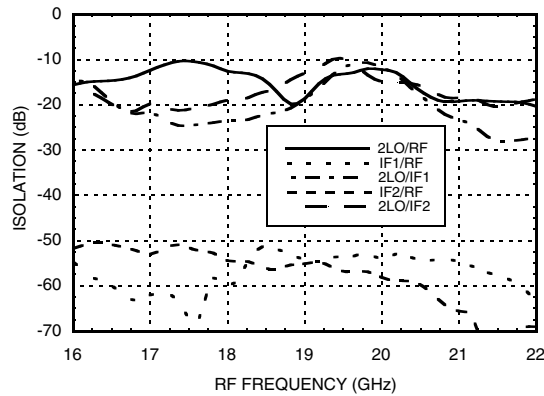

Isolations with LO [1]

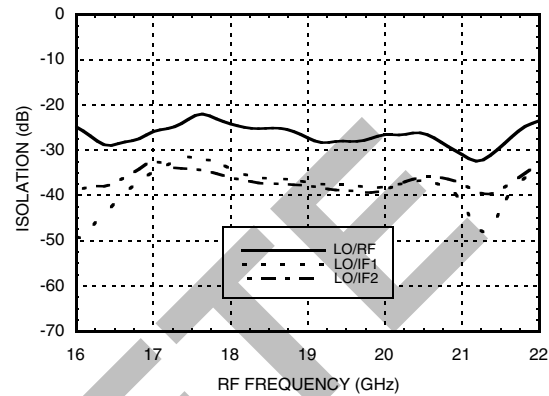

MxN Spurious Outputs [1]

mIF	nLO				
	0	1	2	3	4
0	xx	19	48	xx	xx
1	61	0	66	xx	xx
2	35	32	53	xx	xx
3	61	38	72	xx	xx
4	52	62	73	xx	xx

IF = 1 GHz @ 0 dBm  
 LO = 9.75 GHz @ +6 dBm  
 Data taken without IF hybrid  
 All values in dBc below RF power level (-1IF + 2LO)

Harmonics of LO

LO Freq. (GHz)	nLO Spur @ IF Port			
	1	2	3	4
8	42	21	25	64
9	35	24	47	50
10	38	19	49	47
11	42	25	44	51
12	34	18	50	xx
13	39	32	55	xx
14	22	35	52	xx

[1] Data taken without external IF hybrid

## GaAs MMIC I/Q UPCONVERTER 16 - 21 GHz



### Absolute Maximum Ratings

Drain Bias Voltage (Vdd1, 2, 3)	5.25V
Gate Bias Voltage (Vgg)	-3 to 0V
IF Input Power (IF1, IF2)	20 dBm
LO Drive (LO IN)	20 dBm
Channel Temperature	175 °C
Continuous Pdiss (T = 85°C) (derate 16.2 mW/°C above 85°C)	1.46 mW
Thermal Resistance (channel to ground paddle)	61.8 °C/W
Storage Temperature	-65 to +150 °C
Operating Temperature	-55 to +85 °C
ESD Sensitivity (HBM)	Class 1A



ELECTROSTATIC SENSITIVE DEVICE  
OBSERVE HANDLING PRECAUTIONS

### Outline Drawing

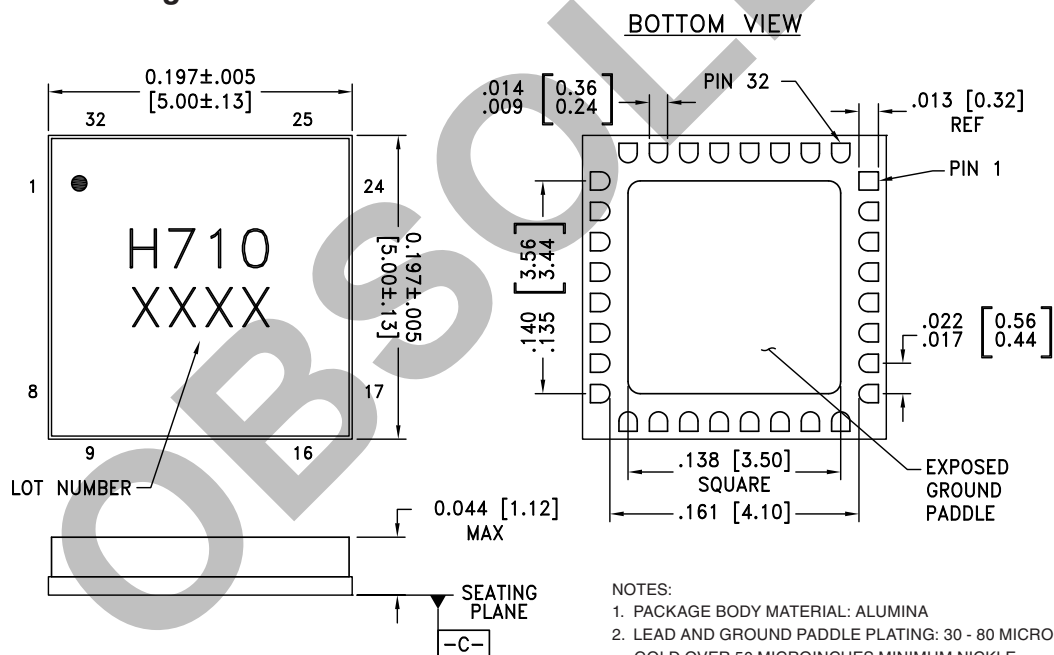

NOTES:

1. PACKAGE BODY MATERIAL: ALUMINA
2. LEAD AND GROUND PADDLE PLATING: 30 - 80 MICROINCHES GOLD OVER 50 MICROINCHES MINIMUM NICKLE
3. DIMENSIONS ARE IN INCHES [MILLIMETERS]
4. LEAD SPACING TOLERANCE IS NON-CUMULATIVE
5. PACKAGE WARP SHALL NOT EXCEED 0.05mm DATUM
6. ALL GROUND LEADS AND GROUND PADDLE MUST BE SOLDERED TO PCB RF GROUND

### Package Information

Part Number	Package Body Material	Lead Finish	MSL Rating	Package Marking <sup>[2]</sup>
HMC710LC5	Alumina, White	Gold over Nickel	MSL3 <sup>[1]</sup>	H710 XXXX

[1] Max peak reflow temperature of 260 °C

[2] 4-Digit lot number XXXX



**GaAs MMIC I/Q UPCONVERTER  
16 - 21 GHz**

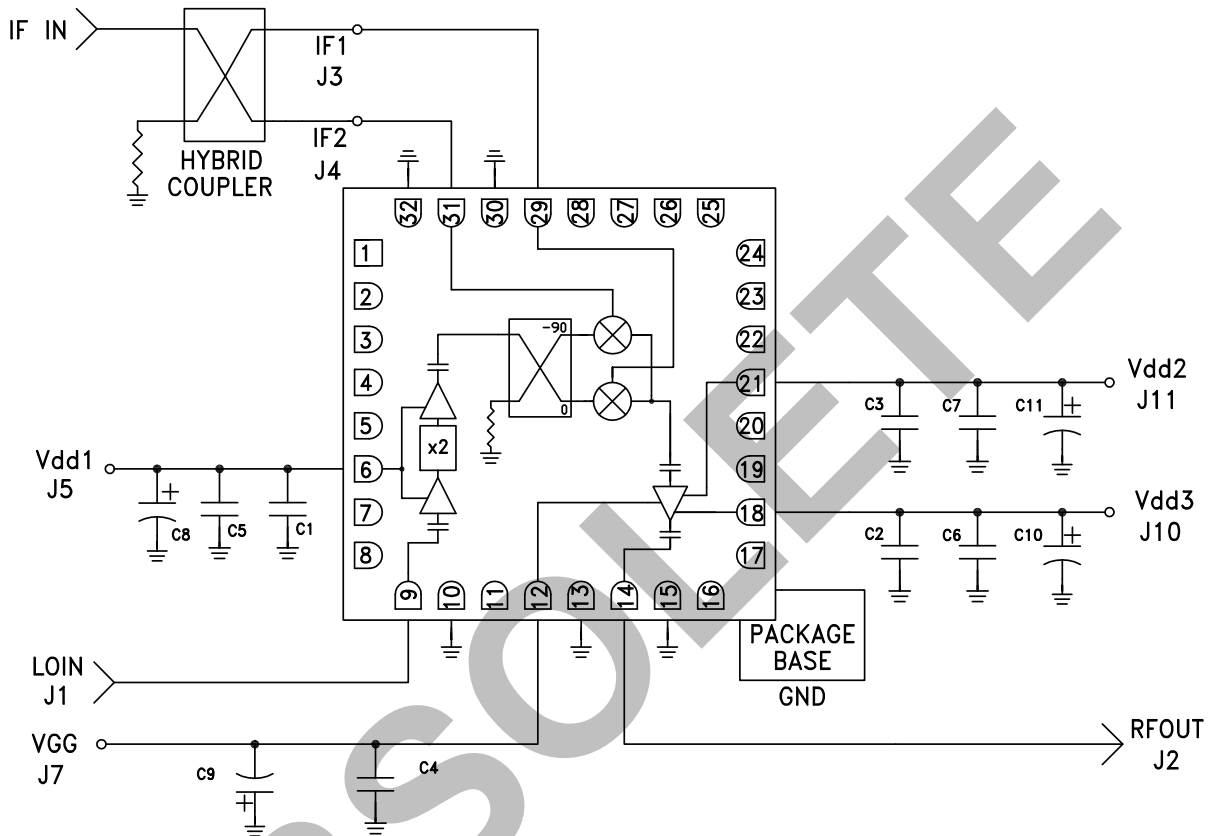

**Typical Application**



C1 - C3	100 pF
C4 - C7	1000 pF
C8 - C11	2.2 $\mu$ F

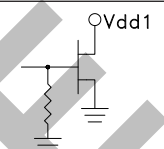

### Pin Descriptions

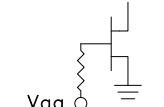
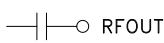
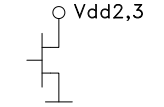
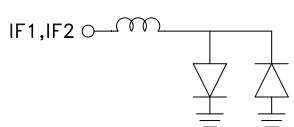
Pin Number	Function	Description	Interface Schematic
1 - 5, 7, 8, 11, 16, 17, 19, 20, 22 - 28	N/C	No Connection required. These pins may be connected to RF/DC ground without affecting performance.	
6	Vdd1	Power supply voltage for x2 multiplier. See application circuit for required external components.	
9	LOIN	This pin is AC coupled and matched to 50 Ohms.	
10, 13, 15, 30, 32	GND	These pins and package bottom must be connected to RF/DC ground.	
12	Vgg	Gate control for RF amplifier, please follow "MMIC Amplifier Biasing Procedure" application note. See application circuit for required external components	
14	RFOUT	This pin is AC coupled and matched to 50 Ohms.	
18, 21	Vdd2, Vdd3	Power supply voltage for RF amplifier. See application circuit for required external components.	
29	IF1	Differential IF input pins. For applications not requiring operation to DC, an off chip DC blocking capacitor should be used. For operation to DC this pin must not source/sink more than 3mA of current or part non function and possible part failure will result.	
31	IF2		



**Evaluation PCB**

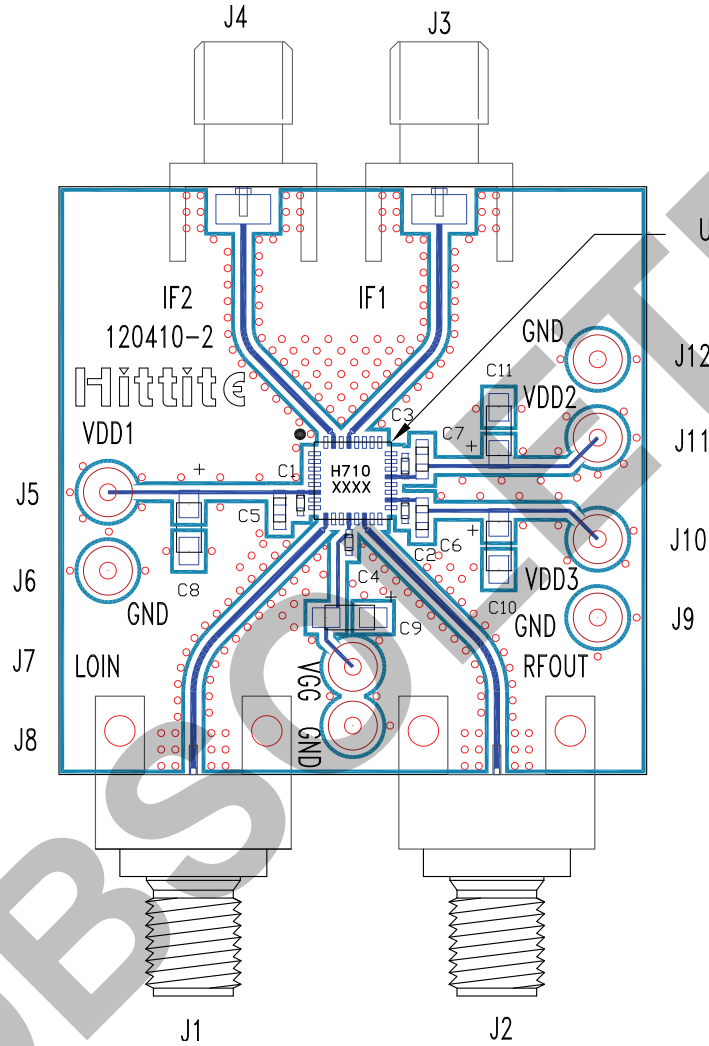

**List of Materials for Evaluation PCB 120412 [1]**

Item	Description
J1, J2	PCB Mount SMA SRI Connector
J3, J4	PCB Mount SMA Connector
J5 - J12	DC Pin
C1 - C3	100 pF Capacitor, 0402 Pkg.
C4	1000 pF Capacitor, 0402 Pkg.
C5 - C7	1000 pF Capacitor, 0603 Pkg.
C8 - C11	2.2 μF Tantalum Capacitor Case A
U1	HMC710LC5 Upconverter
PCB [2]	120410 Evaluation Board

[1] Reference this number when ordering complete evaluation PCB

[2] Circuit Board Material: Arlon 25FR, FR4

The circuit board used in the application should use RF circuit design techniques. Signal lines should have 50 Ohm impedance while the package ground leads and exposed paddle should be connected directly to the ground plane similar to that shown. A sufficient number of via holes should be used to connect the top and bottom ground planes. The evaluation circuit board shown is available from Hittite upon request.