

# Confocal Fiber Displacement Sensor ZW Series

The 24×24×64-mm Sensor Head redefines the meaning of ultra-compact



New  
Right-angle type

**EtherCAT** Standard Feature

- » Robust Sensor Head Structure
- » Ultra-compact and Ultra-lightweight
- » Stable Measurements for Any Material

# Goes beyond traditional displacement sensor concepts with a new confocal principle.

Displacement Sensors are indispensable in non-contact measurement of heights, thicknesses, and other dimensions in machine operation control. However, building them into the system has always presented problems. The Confocal Fiber Displacement ZW Series Sensor solves these problems in ways that were not possible with traditional triangulation. The ZW-series Sensors provide the compact size, light weight, immunity to electrical/magnetic noise, and other features to make them ideal for solving installation space problems. And OMRON's new confocal principle provides the measurement resolution that is needed for operation control. The ZW Series solves the problems that came with laser triangulation, such as deviations between different materials and inclination tolerance.

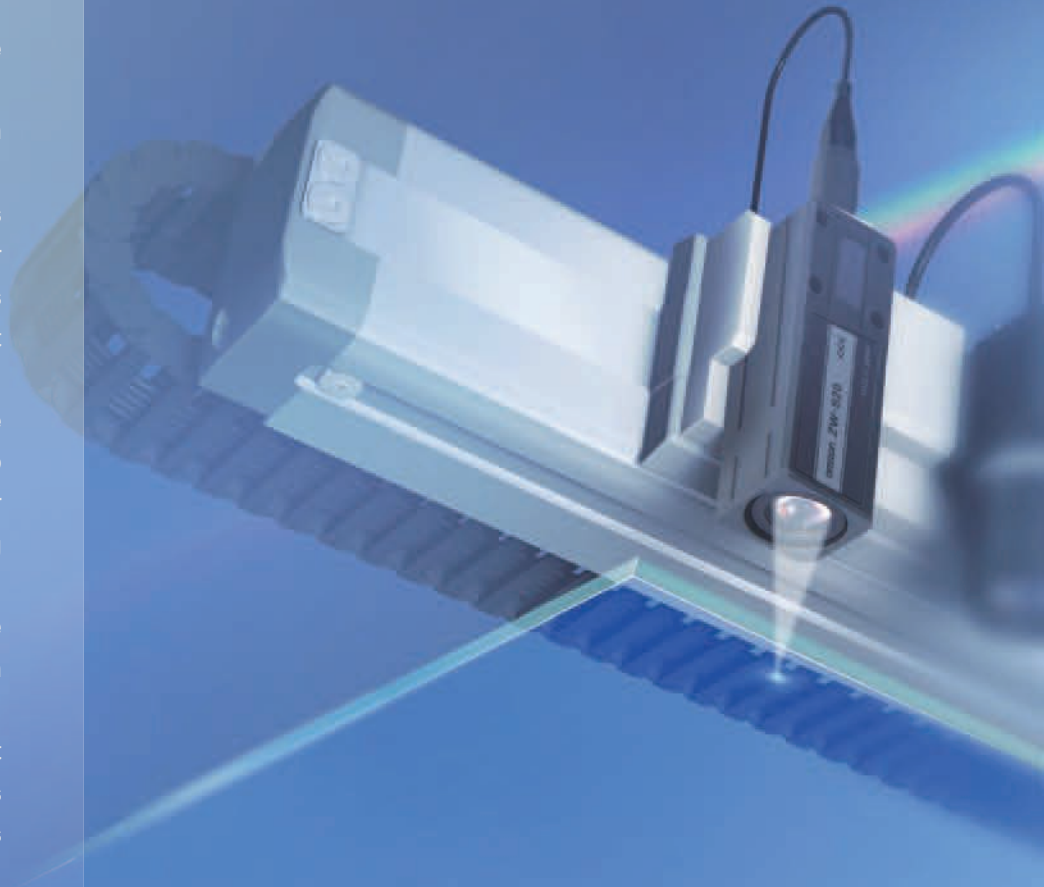

## Two Types of Sensor Heads

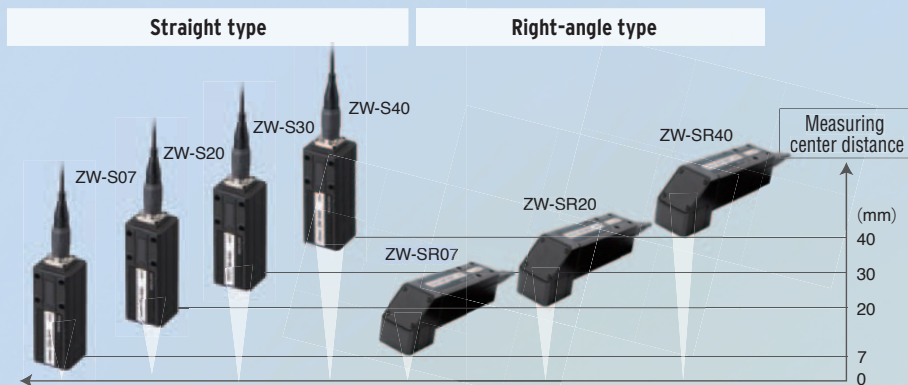

## Expanded Communications

Standard-feature EtherCAT

> p.10

Standard-feature EtherNet/IP™



-EtherCAT® is a registered trademark and patented technology, licensed by Beckhoff Automation GmbH, Germany.

-EtherNet/IP™ are the trademarks of ODVA.

-ATI™, Radeon™ are trademarks of Advanced Micro Devices, Inc. in USA.

-Sysmac is a trademark or registered trademark of OMRON Corporation in Japan and other countries for OMRON factory automation products.

-Microsoft, Visual Basic, and Windows are either registered trademark of Microsoft Corporation in the United States and other countries.

-Other company names and product names in this document are the trademarks or registered trademarks of their respective companies.

## The Three Benefits of OMRON's White Light Confocal Principle



### Ultra-compact and Ultra-lightweight

The slim design measures only 24 × 24 mm. It weighs only 105 g. This incredibly compact size could not be achieved with traditional triangulation. Any objects can be measured with the Sensor mounted perpendicular to them to save even more space.

> P.4

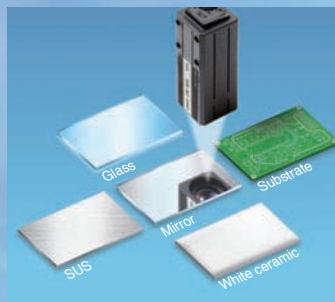

### Stable Measurements for Any Material

You can measure objects of any material or color at the same position. A wide angle characteristic of  $\pm 8^\circ$  enables high-resolution measurement of the position even for large objects with mirror-like surfaces without being affected by warping.

> P.6

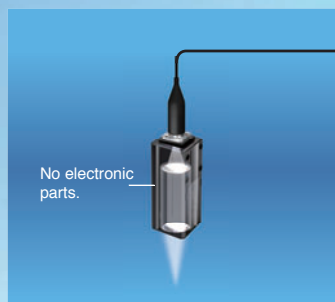

### Robust Sensor Head Structure

The sensor head design maintains reliable operation in installations with electronic and magnetic noise. Devices in close proximity will not be affected by noise or heat from the sensor head or fiber cables due to their advanced design.

> P.8

# Ultra-compact and Ultra-lightweight

## Utilize Narrow Spaces in Machines

The 24 × 24-mm Sensor Head fits easily into essentially any machine.

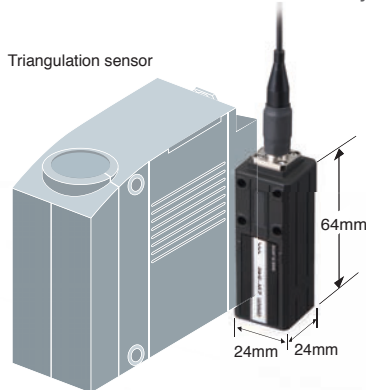

Volume ratio  
1/8\*

Weight ratio  
1/8\*

\*In-house comparisons.

## Mounting area Reduced to 1/7\*

\*In-house comparison.

With traditional triangulation, it was necessary to use either diffuse reflection or regular reflection depending on the material. However, the confocal principle used for the ZW Series eliminates the need to change the Sensor installation even if the material changes.

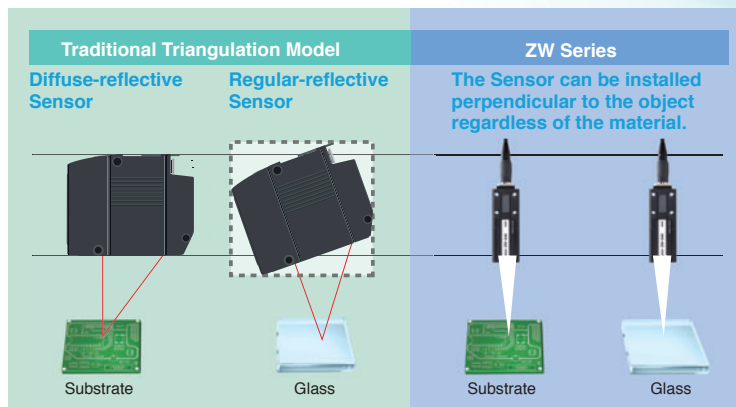

Height Control of a Dispenser Nozzle



Thickness Measurement of a Metal Tube

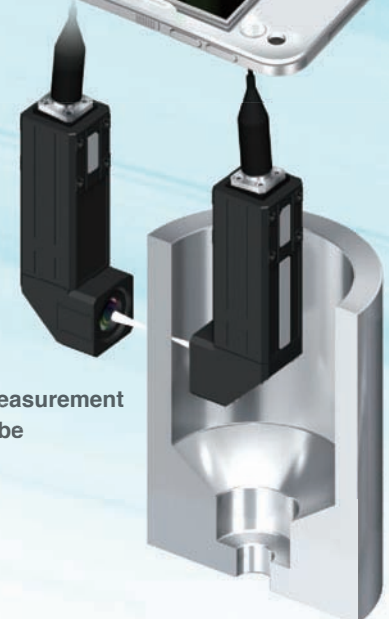

## Installation in Tight Spaces

Space restrictions, heat generation, and mutual interference often prevent side-by-side installation of many traditional triangulation sensors. The compact, non-heat generating ZW-series Sensor Head eliminates these problems. Furthermore, the right-angle type Sensor Head can be installed in a limited space over workpieces without a turning mirror.

The traditional sensors generally measure the thickness of a workpiece by calculating the difference between the heights of the stage and the top surface of the workpiece. The ZW-series Sensor Head can be installed in the small space under the stage to directly measure the height from the top and bottom surfaces of the workpiece, which enables more accurate thickness inspection.

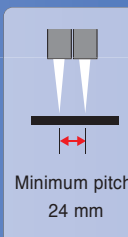

## Thickness Inspection of Small Electronic Parts

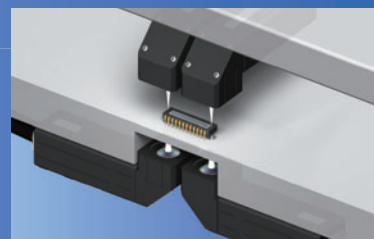

## Smooth Movement and Stopping

Using power cylinders to move sensors to measurement positions only when necessary so that the sensors do not interfere with machine motion resulting in delays in measurements while waiting for settling time if the sensors are heavy. A ZW-series Sensor Head, however, weighs only 105 g so that measurements can be made as soon as the cylinder operation stops.

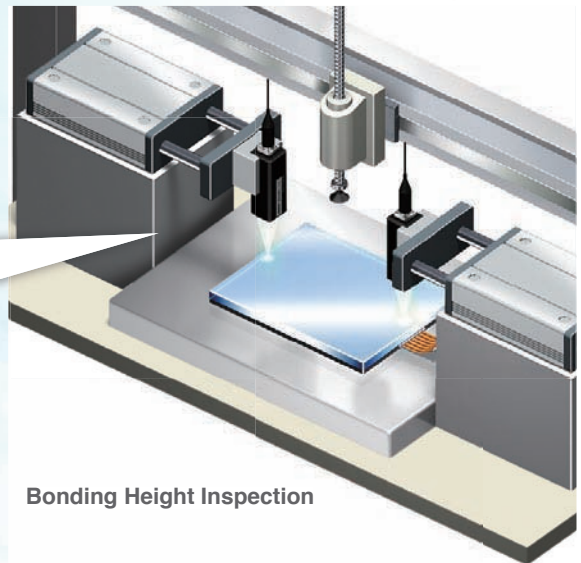
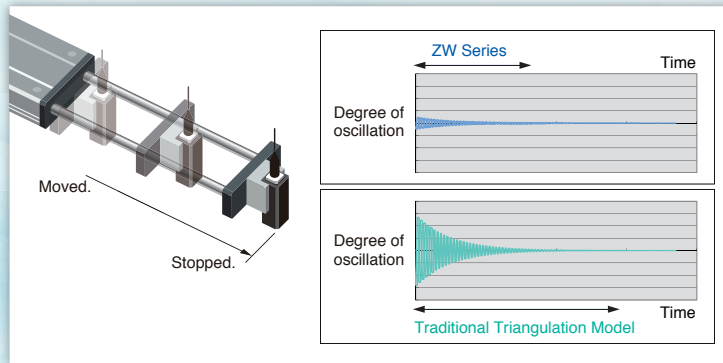

Bonding Height Inspection

## Flexible Fiber Cable for Easy Installation

The Controller connects to the Sensor Head with a 2-mm-diameter Flexible Fiber Cable. The Cable has cleared a bending test consisting of 2,000,000\* repetitions for reliable application on moving parts.

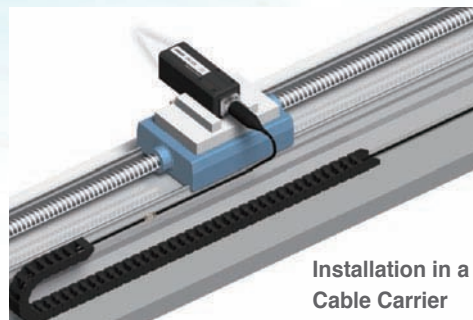

Installation in a Cable Carrier

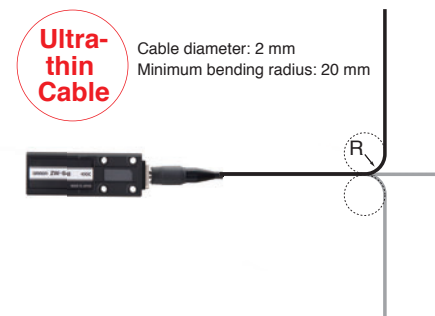

\*Cable was tested with OMRON's bending test consisting of 2,000,000 bends to a 70-mm bending radius and 1,000,000 bends to a 20-mm bending radius.

### Cable Extendable to 32 m

An Extension Fiber Cable can be used between the Sensor Head and Controller to extend the distance to up to 32 m. Attach the Sensor Head to a moving part and place the Controller in the control panel or other convenient location to achieve a flexible system design.

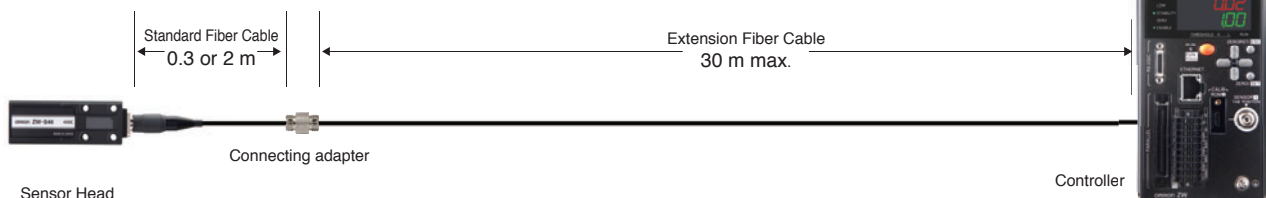

# Stable Measurements for Any Material with Superior Angle Characteristic

## Stable Measurements from the Same Mounting Position Even for Different Materials

There is no need to change or tune the Sensor for each material. Even if the material changes, you can continue to achieve stable measurements with the same Sensor from the same mounting position.

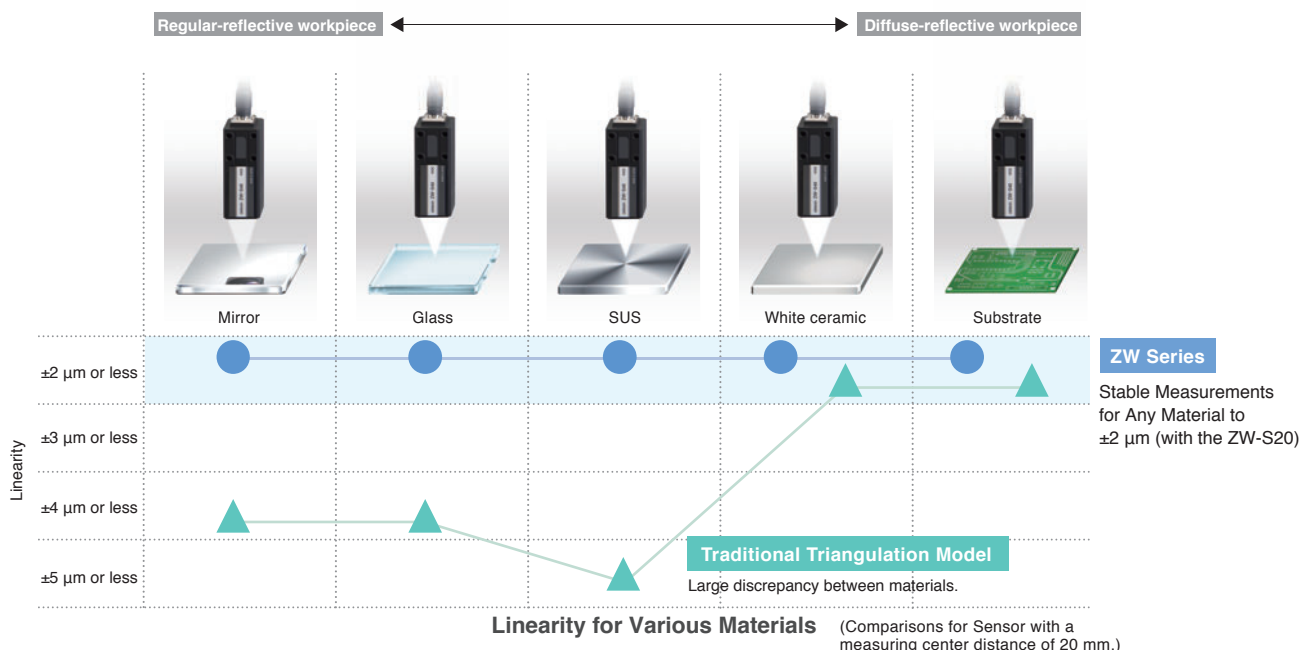

### Stable Measurements across Boundaries between Materials

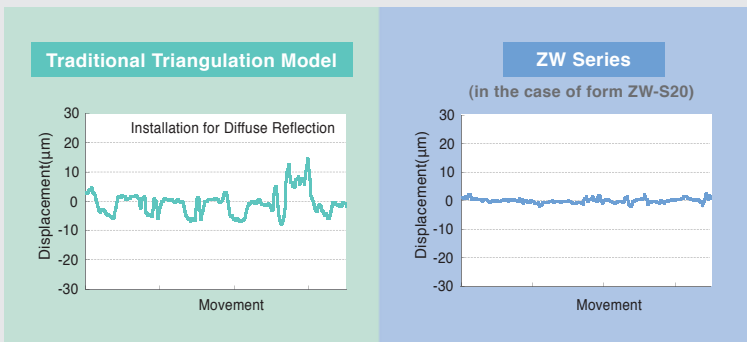

### Compact Sensor Heads Provide Stable Measurements of Thin Transparent Glass

To stably measure transparent glass, the received light waveforms from the front and back surfaces of the glass must be separated. With thin transparent glass, the influence of lens aberration makes it difficult to achieve separation with compact sensor heads. Even with its compact size that saves space, the ZW-S07 stably measures transparent surface displacement on glass as thin as  $70 \mu\text{m}$  min., a feat not easily achieved by previous compact sensor heads.

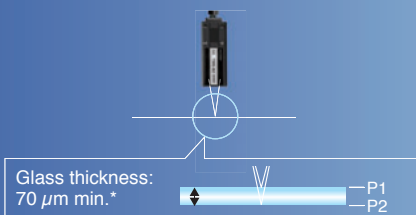

Model	ZW-S07	ZW-S20	ZW-S30	ZW-S40
Glass thickness ( $\mu\text{m}$ )	min. 70	min. 150	min. 600	min. 900
	max. 900	max. 3,000	max. 9,000	max. 18,000

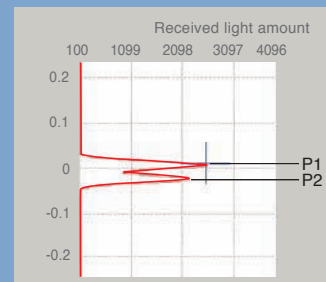

Received Waveform for ZW-series Sensor

(All measurement graphs represent typical examples.)

## Superior Angle Characteristic

When measuring an object that has a mirror-like surface with traditional triangulation, performance is greatly reduced depending on the angle of the Sensor. When many Sensors are used for height control during glass conveyance, the angles of the Sensors must be adjusted with high precision during setup. The confocal Sensor ZW series enables high-resolution measurements without strict angle adjustment. This results in reduction of cost and space for the adjusting jig and time for adjustment.

\* This is not a guaranteed value. Refer to Characteristic Data (P23) for typical examples.

**Angle characteristic  $\pm 8^\circ$  \***

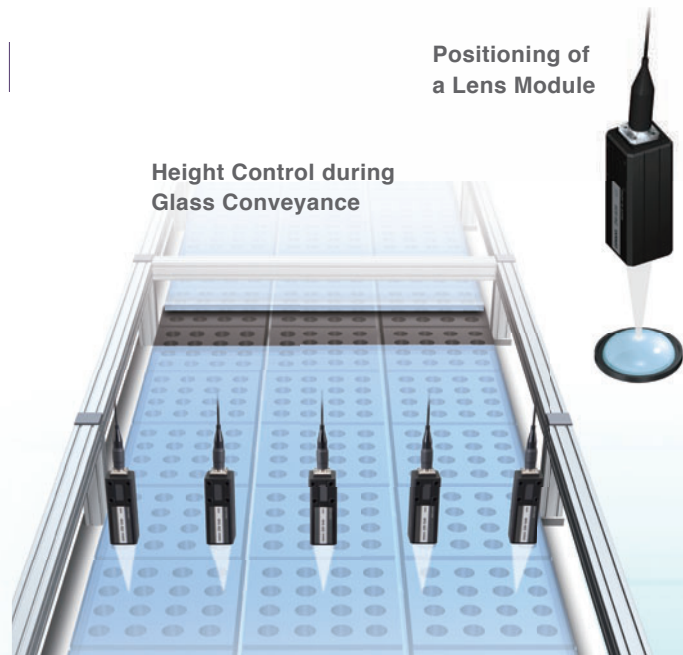

### Traditional Triangulation Model

With triangulation, even if the angle is adjusted with high precision during the setup of the Sensor, stable measurement results are difficult to obtain when the measurement object is warped or inclined.

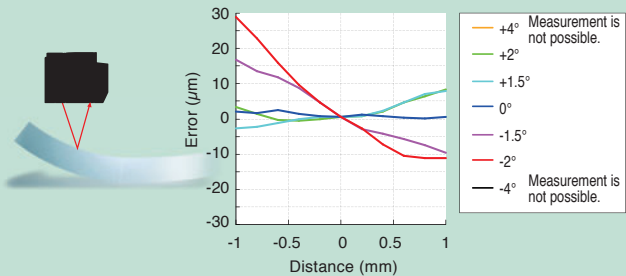

### ZW Series

ZW-series Sensors operate on the confocal principle, so high-resolution measurements are possible regardless of inclination and warping of the measurement object.

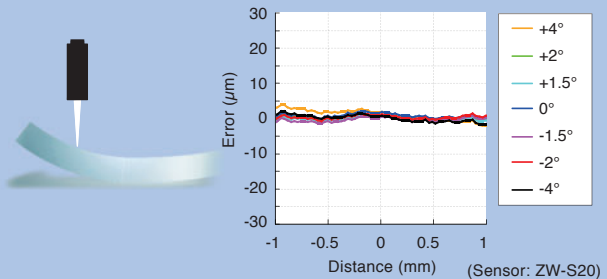

## Further Benefits of Confocal Principle

### No Discrepancy in the Measurement Point

With triangulation, the measurement position and spot size vary with the height. This means there are times when the position cannot be measured with high resolution due to warping and inclination. With the confocal principle used for the ZW Series, the measurement point remains the same at any position in the measuring range so that precise measurements can always be made.

### Measurement in Confined Spaces

When the triangulation sensor measures the inside of a narrow tube or the height of a small depression, the wall often obstructs the reflected light, and the orientation of the sensor and workpiece must be adjusted many times. The ZW Series using the confocal principle can measure the points in narrow spaces or small objects, without changing its installation orientation, because the emitted light and reflected light are positioned along the same axis.

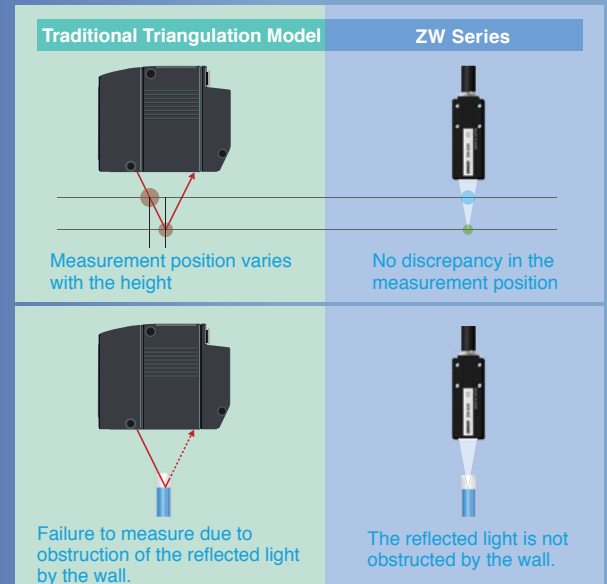

# Robust Sensor Head Structure

## No Noise

Reduced Work for  
EMC Countermeasures

### Not Affected by Noise

To ensure high-resolution measurements with normal sensors, countermeasures must be implemented to protect the sensor from the electromagnetic noise that is emitted by any nearby devices. The ZW-series Sensor Heads, however, contain no electronic parts to enable stable measurements even near power sections. Also, the Fiber Cable that connects the Sensor Head to the Controller can be placed near power lines and other cables that emit noise without affecting operation.

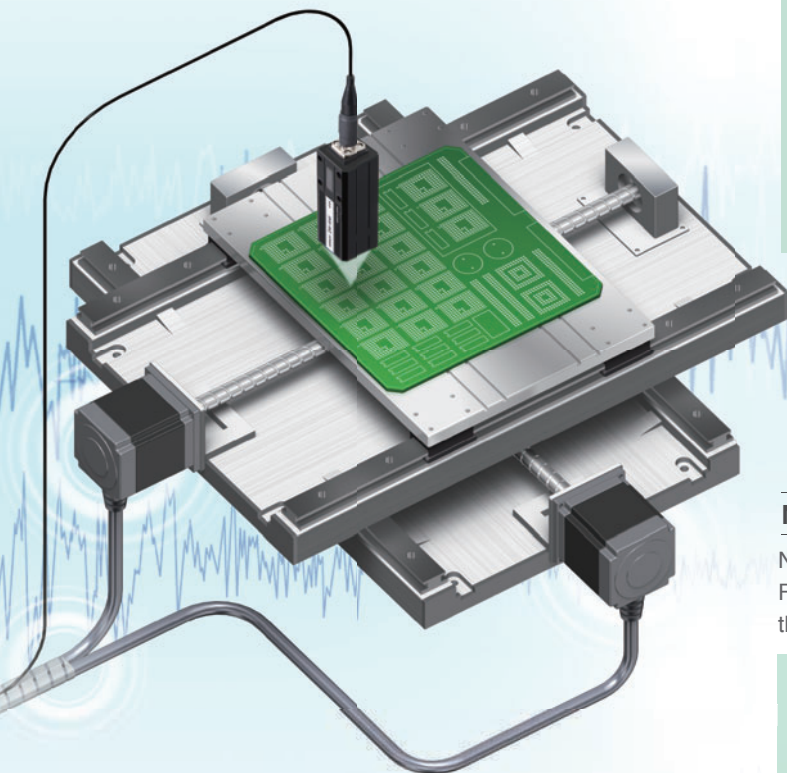

Substrate Height Inspection

#### Traditional Triangulation Model

Changes in Measurement Values Caused by Noise

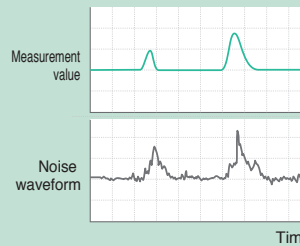

#### ZW Series

Measurements are not affected by noise and remain stable.

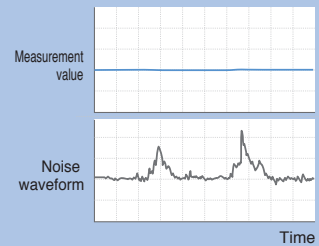

### No Noise Emission

No electronic parts are used in the ZW-series Sensor Heads or Fiber Cables, so they give off no electromagnetic noise. You can therefore use them reliably together with other devices.

#### Traditional Triangulation Model

Electronic parts



Electromagnetic noise is emitted from the sensor and from cables.

#### ZW Series

Fiber Cable



No electronic parts.

No Noise Emitted.



## No Heat Generation

### Reduced Work in Thermal Design

In high-resolution machine control, the heat generated by a sensor head can adversely affect nearby equipment and cause the error to increase. The ZW-series Sensor Heads, however, generate no heat and therefore do not affect nearby equipment. You can also install many Sensor Heads side by side and still be sure of reliable operation.

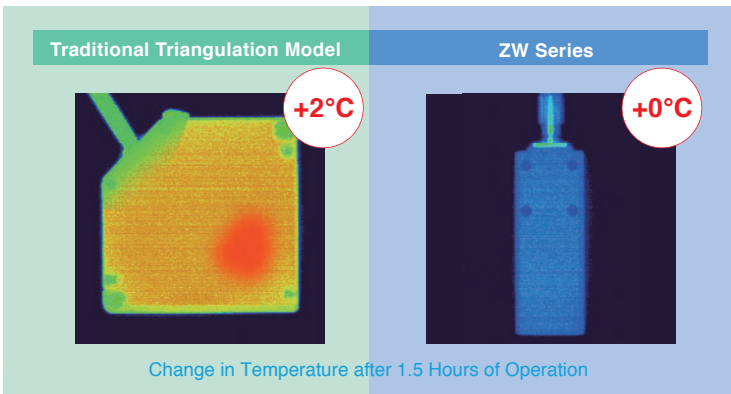

## No Electronic Parts

### Reduced Maintenance Costs

Displacement sensors are often installed in moving applications and other installations that are subject to vibration. It is important that they can withstand this type of requirement. The ZW series Sensor Heads are designed for this type of environment, they have no electronic parts or PCB's that a standard triangulation sensor contains. The reduction of parts to lenses and fiber cables reduces the maintenance requirements, and the LED light source also eliminates the standard safety measures required for lasers.

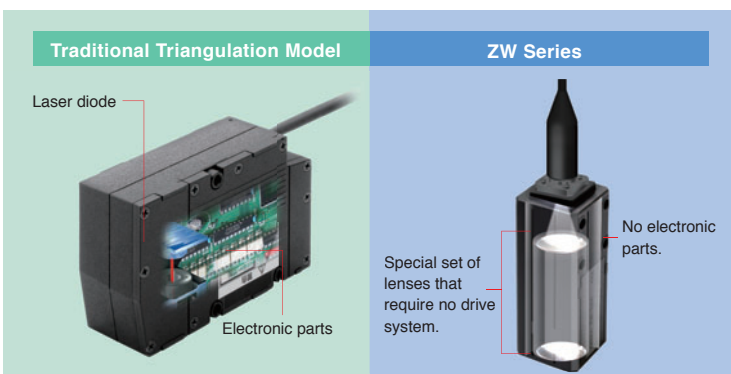

An LED is used in place of a laser for the light source to eliminate the need for safety measures.



Electric circuits and the light source are contained in the Controller.

# EtherCAT

## Machine Control Network

The EtherCAT high-speed open network was optimized for machine control. The ZW-series Sensors are the first OMRON Displacement Sensors with EtherCAT to provide a highly efficient design for high-precision machine control applications that use measurement results to control machine operation.

### Combining Height Information and Position Coordinates

EtherCAT can be used to connect to servo drives or encoder input slaves to quickly get the position coordinates and ZW displacement. The height information and XY position coordinates can be easily linked so that the machine control applications can increase processing precision in respect to the height and the inspection applications benefit from maintenance, such as helping to isolate errors or perform trend analysis.

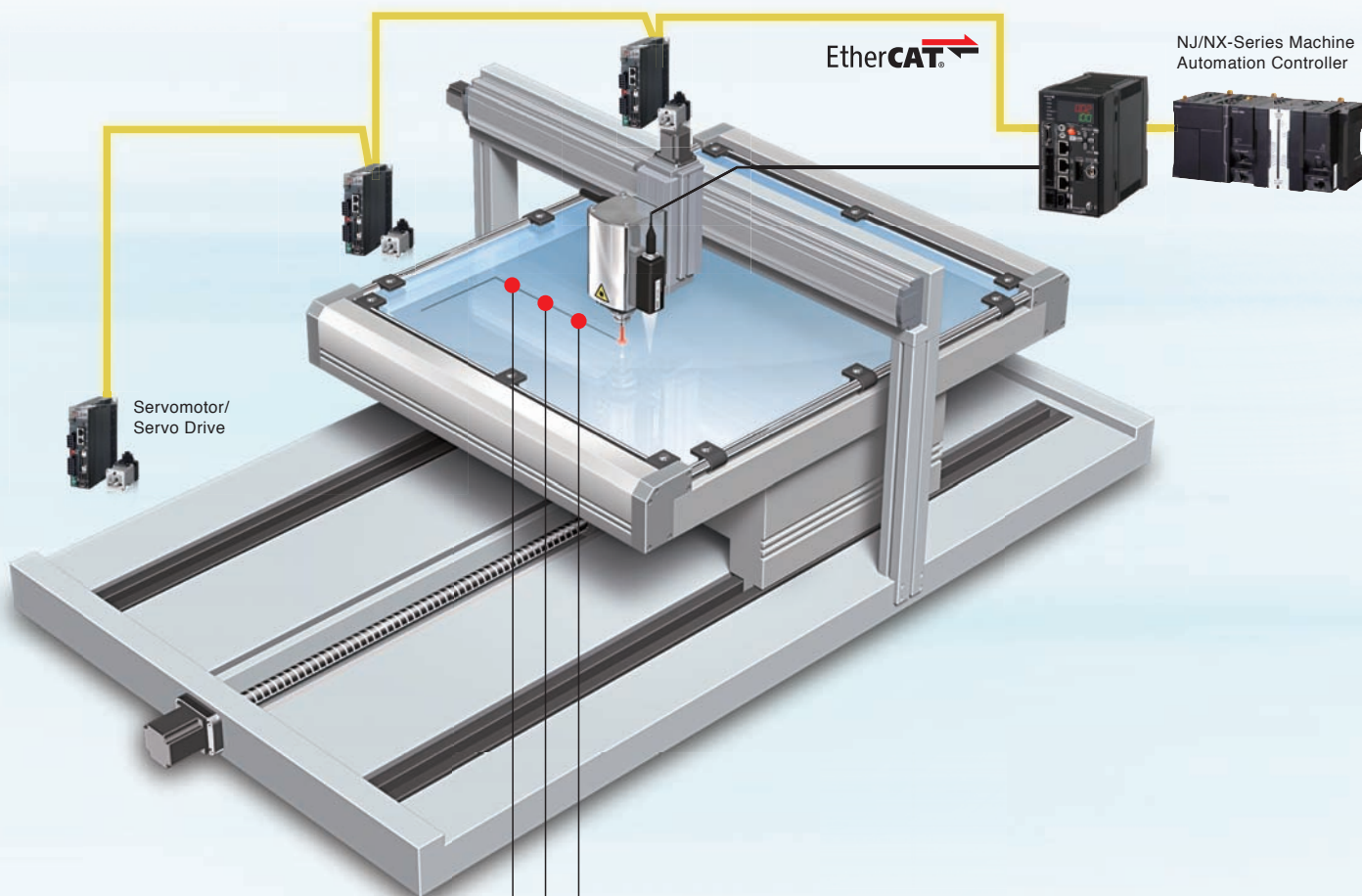

Measurement point	Measurement result Z	Servo/encoder X	Servo/encoder Y
Point 1	Z1	X1	Y1
Point 2	Z2	X2	Y2
Point 3	Z3	X3	Y3
⋮	⋮	⋮	⋮

#### Results of Linking with the Position Coordinates

##### Machine Controls

Increased processing precision

No need for constant-speed control

##### Inspection Applications

Isolation of errors

Trend management for specific positions

## High-speed Digital Output

Shorter Machine Takt Times

With previous digital (serial) outputs through Ethernet or RS-232C, the response period for measurement commands was both inconsistent and slow, making them unsuitable for realtime control. With EtherCAT, a constant period as short as 500  $\mu$ s enables continuous digital (serial) outputs so that the overall workpiece height information can be mapped at high speed.

Previous Serial Output	EtherCAT Output for ZW-series Sensor
<p>The outputs for command inputs required 5 ms or longer and were not consistent.</p> <p><b>Measurement Commands</b></p>	<p>Measurement values are output continuously at a fixed period that is as short as 500 <math>\mu</math>s.</p> <p>Continuous outputs at a period that is as short as <b>500 <math>\mu</math>s</b>.</p> <div style="border: 2px solid red; border-radius: 50%; padding: 10px; text-align: center; width: fit-content; margin: 20px auto;"> <p><b>8 Times Faster Than OMRON's Previous Models</b></p> </div>

## Tracing Machine Movement

Fewer Steps in System Commissioning

You can develop, test, and adjust devices that are connected via EtherCAT with just one Support Software package. The Automation Software Sysmac Studio allows you to creatively design your controls. You can see the entire range from sensing to motion control to reduce the number of steps required to commission the system or to aid in troubleshooting. There are also plenty of offline features to debug signal control programming. You can also simulate machine operation before actual application onsite.

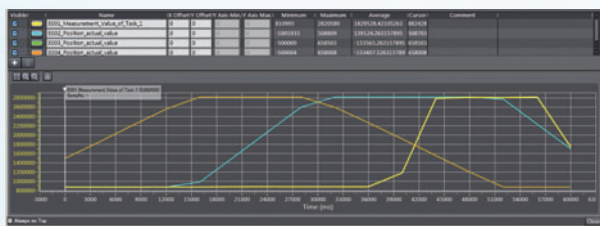

Data Trace

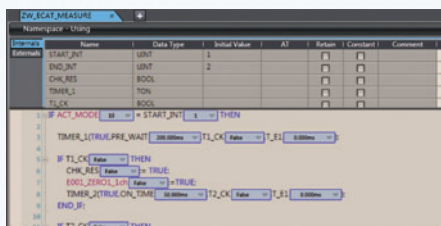

Debugging Control Programming

Note: Sysmac Studio version 1.05 or higher is required for these software interface features described.

## Long-distance Wiring: 100 m

Flexible Wiring for Machines

You can use EtherCAT to connect slaves that are up to 100 m apart. With digital communications, error does not occur due to the influences of ambient noise. This solves the previous problems with analog output methods, such as the inability to support long-distance transmissions and noise countermeasures, and enables reliable installation in previously difficult large-scale machines.

- Sysmac is a trademark or registered trademark of OMRON Corporation in Japan and other countries for OMRON factory automation products.
- Windows is registered trademarks of Microsoft Corporation in the USA and other countries.
- Other company names and product names in this document are the trademarks or registered trademarks of their respective companies.
- Microsoft product screen shot(s) reprinted with permission from Microsoft Corporation.

# Multipoint Measurement with EtherCAT Concurrency

EtherCAT communications provide both high speed and time-consistent performance so that integrated controls for Sensors and other slaves can be achieved in realtime. Even for multipoint measurements for Displacement Sensor applications, the following advantages are provided.

## Reduced Wiring: Only Two Cables Less Wiring for Many Sensors

With previous parallel I/O, manual wiring was required for dozens of points, and it was necessary to take sufficient caution to avoid sources of noise. This required extensive time to use many Displacement Sensors in a row. With EtherCAT, all you have to do is connect two lines for each Controller.

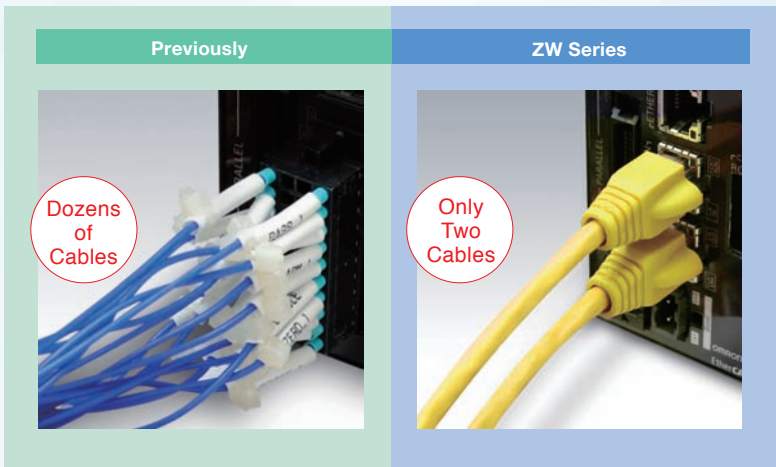

NJ/NX-Series Machine Automation Controller



## One Software Fewer Steps in System Design

You can set up all of the slaves that are connected via EtherCAT with just the Automation Software Sysmac Studio. Even when you combine many Sensors, you can copy setup data to effectively integrate setup work or you can easily program calculations between the Sensors.

Sysmac Studio

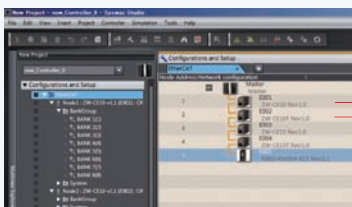

Efficient Setup of Measurement Conditions for Many Sensors

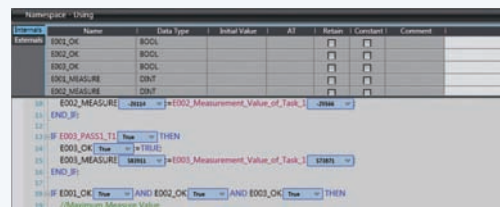
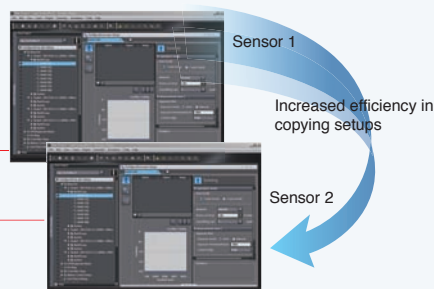

Easy Programming of Thickness Calculations

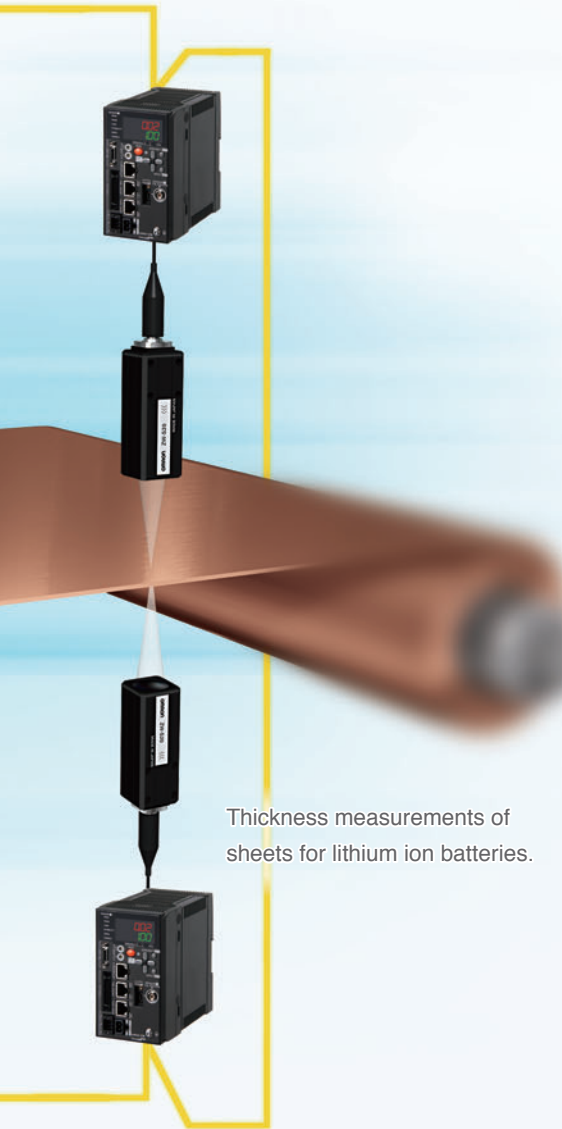

Thickness measurements of sheets for lithium ion batteries.

## Synchronous Measurements

### Fewer Thickness Errors due to Vibration

The highly precise synchronization performance of EtherCAT reduces the time error in measurements between different Sensors to 1  $\mu$ s or less. Synchronous measurement is useful when measurements must be made with more than one Sensor at the same time, such as measurements from both sides of a sheet or inclination control of a substrate.

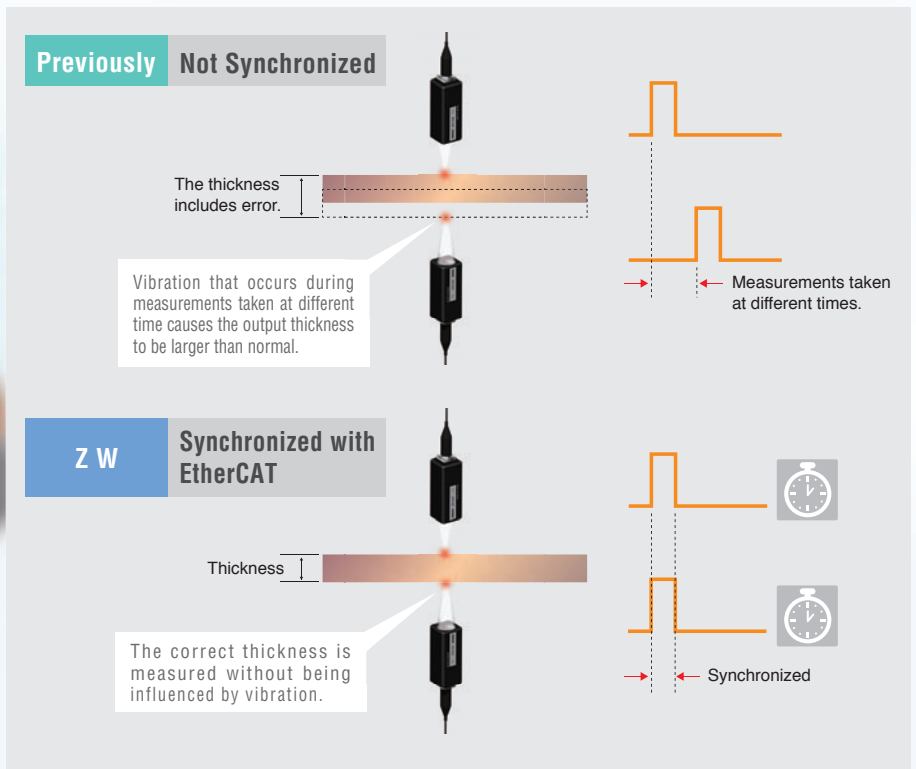

## Continuous Measurements of Sheets without Position Offset

When Sensors are installed in a row to continuously log sheet height, nonsynchronous measurements can cause offsets in the lateral measurement positions. With synchronous measurements using EtherCAT, you can continuously log sheet height with all of the Sensors at the same lateral position.

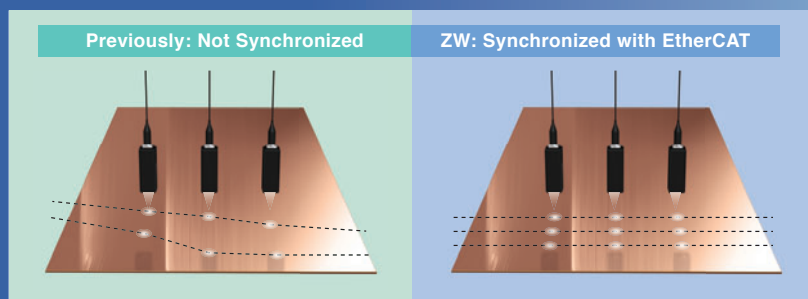

# Robust Sensor Head Structure

To achieve a compact Sensor Head and high-resolution measurements, the ZW Series uses a white light confocal principle to detect objects. This principle is described below.

## Confocal principle Confocal Light Emission and Reception

Based on the confocal principle, the emitted light and received light are positioned along the same axis. Light is received only when it is focused on the measurement object, allowing the height to be calculated. Unlike triangulation, the received light waveform is not disrupted by the material or inclination of the measurement object. The received light waveform is always stable, which enables high-resolution measurements.

### Object Located at Focal Point

The reflected light is focused at the same point as the emitted light. The reflected light becomes the received light signal.

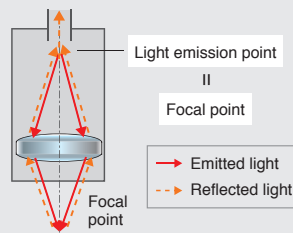

The height is calculated from the position at which the reflected light was received.

### Object Not Located at Focal Point

Reflected light is not received because the reflected light is not focused at the light emission point.

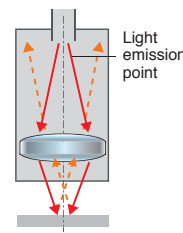

Light is not received.

### Inclination and Differences in Materials

Even if the measurement object is inclined or contains different materials, the reflected light will be focused at the light emission point as long as the measurement object is at the focal point.

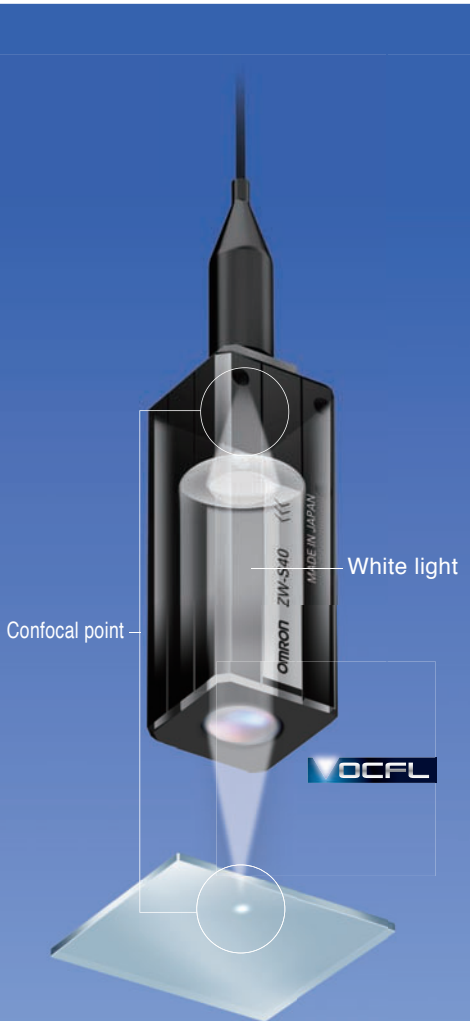
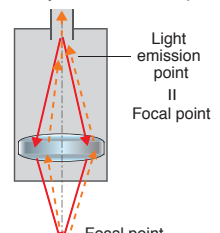

### OCFL Module

The OCFL module contains a special lens set developed by OMRON that changes the focal point for each color (i.e., wavelength) of white light. The spot diameter is the same at any position within the measuring range. It does not change the way it does for a triangulation. High-precision lens manufacturing technology has allowed us to achieve a lens structure that is extremely small and that also does not require a drive mechanism.



\*OCFL : Omron Chromatic Focus Lens

## White Light Separation into Colors with Different Wavelengths at Emission

Patent Pending

The white light from the LED is focused at different points for each color (i.e., wavelength) due to a special set of lenses in the OCFL module in the Sensor Head. As a result, only the color of light that is focused on the measurement object is returned, allowing the distance from the Sensor Head to the measurement object to be calculated based on the color of the reflected light. The Sensor Head contains the special set of lenses that separates white light into different colors and the Controller contains the white LED light source, and the spectroscopy and processor that convert the color of the reflected light to a distance. There is no need for a lens drive mechanism or electronic parts in the Sensor Head, even though they were considered to be standard in previous confocal models. This achieves a much more compact design and much greater immunity to noise than triangulation models and or previous confocal models.

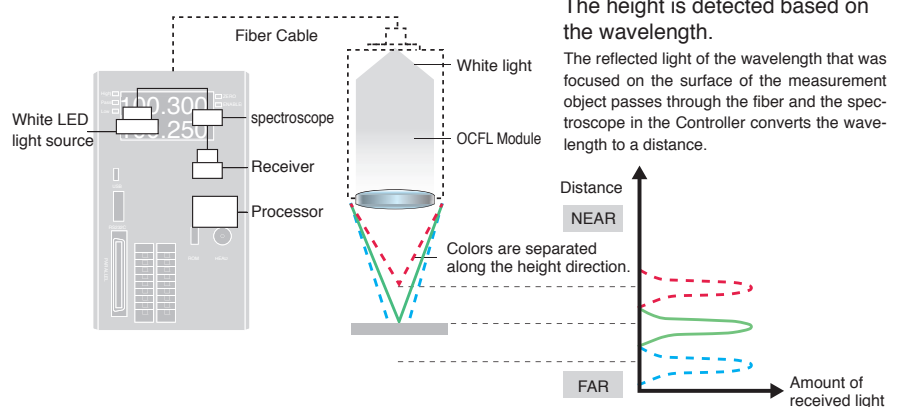

Problems with Previous Models

Triangulation

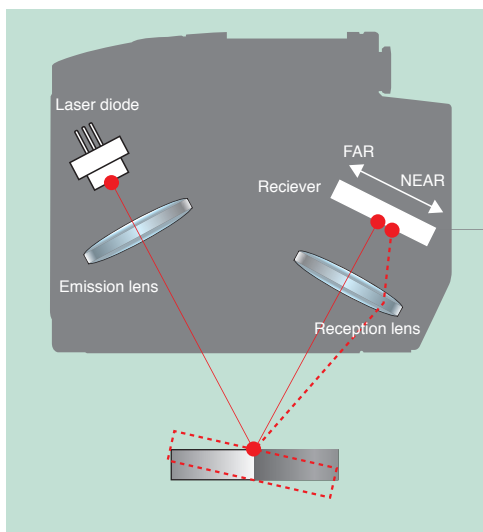

Triangulation measures the height of an object based on the position of the spot on a receiver (CCD or CMOS). The peak, center of gravity, and other features are calculated from the received light waveform to reduce error, but in principle, the received waveform is offset or disrupted due to differences in materials or inclination. This results in measurement error.

Light Reception for Different Materials

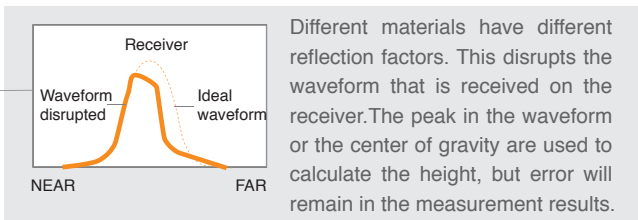

Light Reception for Inclination

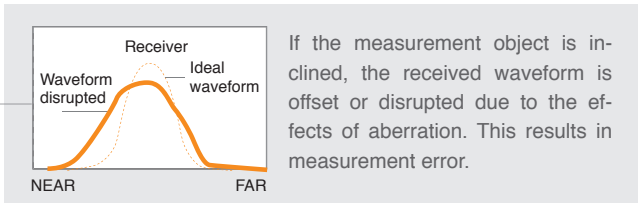

Normal Confocal Principle

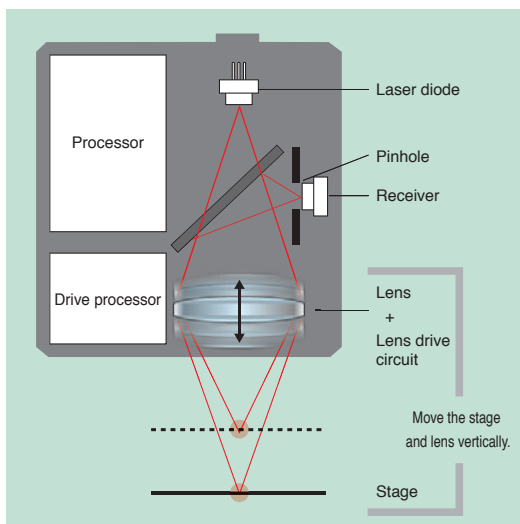

In a normal confocal model, a stage and lens are driven vertically to change the focal point. This requires a more complex structure, and the large number of parts interferes with downsizing. The use of a laser beam increases the chances of interference, and the received light waveform can be disrupted by the surface conditions within the small spot on the measurement object.

# System Configuration

## EtherCAT connections

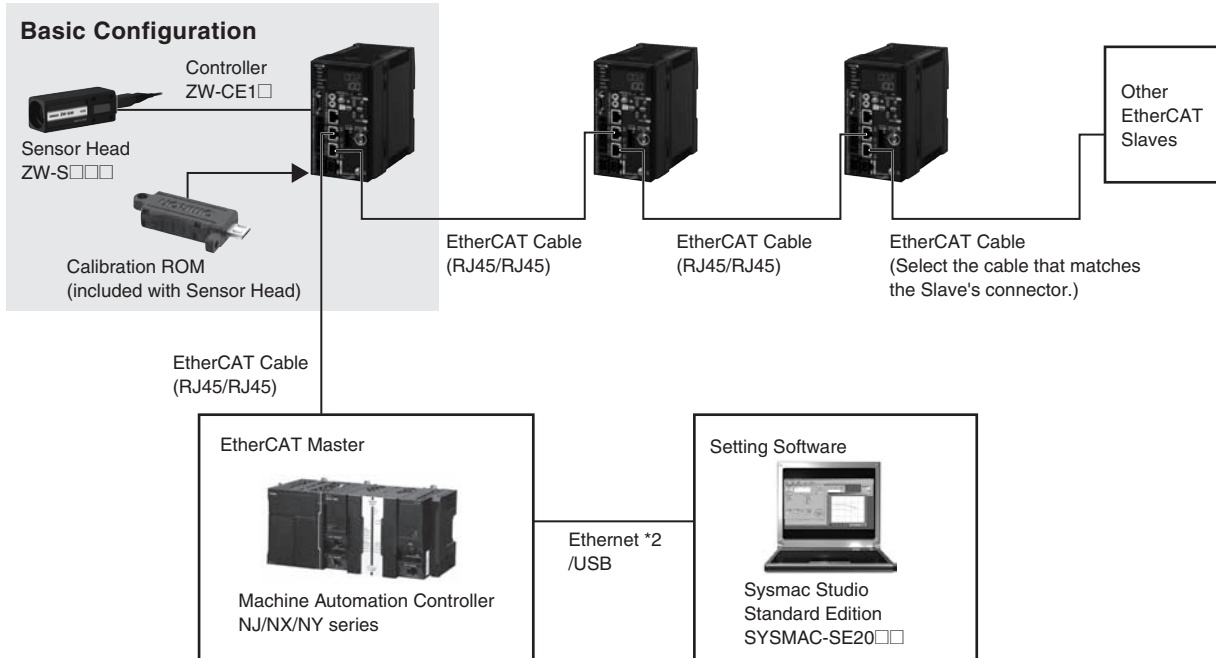

## Analog, EtherNet/IP, Ethernet, RS-232C and Parallel connections

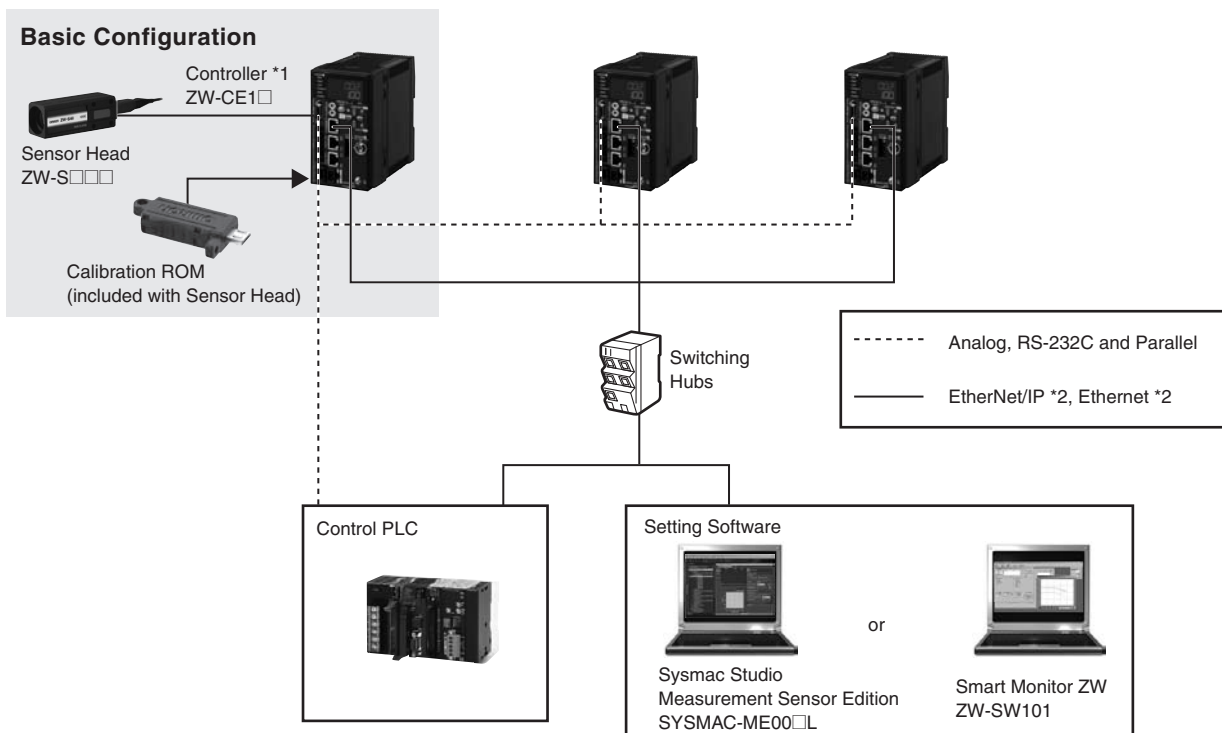

\*1 Controllers with binary outputs are also available (ZW-C10T/C15T).  
Please contact your OMRON sales representative for details.

\*2 Prepare commercially available Ethernet cable satisfying the following requirements:

- Category 5e or more, 30 m or less
- RJ45 connector (8-pin modular jack)
- For direct connection: Select cross cable.
- For connection through an industrial switching hub: Select straight cable.



## Order Information

### ● Sensor Head

Straight type

Right-angle type





	7±0.3mm	20±1mm	30±3mm	40±6mm	7±0.3mm	20±1mm	40±6mm
Measuring range:	7±0.3mm	20±1mm	30±3mm	40±6mm	7±0.3mm	20±1mm	40±6mm
Spot diameter	18µm dia.	40µm dia.	60µm dia.	80µm dia.	18µm dia.	40µm dia.	80µm dia.
Static resolution	0.25µm	0.25µm	0.25µm	0.25µm	0.25µm	0.25µm	0.25µm
Model	ZW-S07 2M	ZW-S20 2M	ZW-S30 2M	ZW-S40 2M	ZW-SR07 2M	ZW-SR20 2M	ZW-SR40 2M
	ZW-S07 0.3M	ZW-S20 0.3M	ZW-S30 0.3M	ZW-S40 0.3M	ZW-SR07 0.3M	ZW-SR20 0.3M	ZW-SR40 0.3M

### ● Controller with EtherCAT

Appearance	Power supply	Output type	Model
	DC24V	NPN	ZW-CE10T
		PNP	ZW-CE15T

**Note:** Controllers with binary outputs are also available (ZW-C10T/-C15T). Please contact your OMRON sales representative for details.

### ● Cable

Appearance	Item	Cable length	Model
	Sensor Head - Controller Extension Fiber Cable (flexible cable) (Fiber Adapter ZW-XFC provided)	2m	ZW-XF02R
		5m	ZW-XF05R
		10m	ZW-XF10R
		20m	ZW-XF20R
		30m	ZW-XF30R
	Fiber Adapter (between Sensor Head pre-wired cable and Extension Fiber Cable)	—	ZW-XFC
	Parallel cable for ZW-CE1□T 32-pole* (included with Controller ZW-CE1□T)	2m	ZW-XCP2E
	RS-232C Cable for personal computer	2m	ZW-XRS2
	RS-232C Cable for PLC/programmable terminal	2m	ZW-XPT2

\* A parallel cable for Controllers with binary outputs is also available (ZW-XCP2). Please contact your OMRON sales representative for details.

### ● Automation Software Sysmac Studio

Please purchase a DVD and required number of licenses the first time you purchase the Sysmac Studio. DVDs and licenses are available individually.

Each model of licenses does not include any DVD.

Product name	Specifications			Model	Standards
		Number of licenses	Media		
Sysmac Studio Standard Edition Ver.1.□□ *2	The Sysmac Studio is the software that provides an integrated environment for setting, programming, debugging and maintenance of machine automation controllers including the NJ/NX-series CPU Units, NY-series Industrial PC, EtherCat Slave, and the HMI.  Sysmac Studio runs on the following OS. Windows 7 (32-bit/64-bit version)/Windows 8 (32-bit/64-bit version)/Windows 8.1 (32-bit/64-bit version)/Windows 10 (32-bit/64-bit version)  This software provides functions of the Measurement Sensor Edition. Refer to your OMRON website for details such as supported models and functions.	— (Media only)	DVD	SYSMAC-SE200D	—
		1 license*1	—	SYSMAC-SE201L	—
Sysmac Studio Measurement Sensor Edition Ver.1.□□ *3	Sysmac Studio Measurement Sensor Edition is a limited license that provides selected functions required for ZW-series Displacement Sensor settings. Because this product is a license only, you need the Sysmac Standard Edition DVD media to install it.	1 license	—	SYSMAC-ME001L	—
		3 license	—	SYSMAC-ME003L	—

\*1. Multi licenses are available for the Sysmac Studio (3, 10, 30, or 50 licenses).

\*2. ZW-series is supported by Sysmac Studio version 1.05 or higher.

\*3. The Setting Software Smart Monitor ZW is also available (ZW-SW101). Please contact your OMRON sales representative for details.

### ● Accessories





Item	Model
Fiber Connector Cleaner	ZW-XCL

**Note:** Place orders in units of boxes (contacting 10 units).

## ●Recommended EtherCAT Communications Cables

Use Straight STP (shielded twisted-pair) cable of category 5 or higher with double shielding (braiding and aluminum foil tape) for EtherCAT.

### ●Cabel with Connectors

Item	Appearance	Recommended manufacturer	Cable length(m) *1	Model
Standard type Cable with Connectors on Both Ends (RJ45/RJ45) Wire Gauge and Number of Pairs: AWG26, 4-pair Cable Cable Sheath material: LSZH *2 Cable color: Yellow *3		OMRON	0.3	XS6W-6LSZH8SS30CM-Y
			0.5	XS6W-6LSZH8SS50CM-Y
			1	XS6W-6LSZH8SS100CM-Y
			2	XS6W-6LSZH8SS200CM-Y
			3	XS6W-6LSZH8SS300CM-Y
			5	XS6W-6LSZH8SS500CM-Y
Rugged type Cable with Connectors on Both Ends (RJ45/RJ45) Wire Gauge and Number of Pairs: AWG22, 2-pair Cable		OMRON	0.3	XS5W-T421-AMD-K
			0.5	XS5W-T421-BMD-K
			1	XS5W-T421-CMD-K
			2	XS5W-T421-DMD-K
			5	XS5W-T421-GMD-K
			10	XS5W-T421-JMD-K
Rugged type Cable with Connectors on Both Ends (M12 Straight/RJ45) Wire Gauge and Number of Pairs: AWG22, 2-pair Cable		OMRON	0.3	XS5W-T421-AMC-K
			0.5	XS5W-T421-BMC-K
			1	XS5W-T421-CMC-K
			2	XS5W-T421-DMC-K
			5	XS5W-T421-GMC-K
			10	XS5W-T421-JMC-K
Rugged type Cable with Connectors on Both Ends (M12 Right-angle/RJ45) Wire Gauge and Number of Pairs: AWG22, 2-pair Cable		OMRON	0.3	XS5W-T422-AMC-K
			0.5	XS5W-T422-BMC-K
			1	XS5W-T422-CMC-K
			2	XS5W-T422-DMC-K
			5	XS5W-T422-GMC-K
			10	XS5W-T422-JMC-K

**Note:** For details, refer to Cat.No.G019.

\*1. Standard type cables length 0.2, 0.3, 0.5, 1, 1.5, 2, 3, 5, 7.5, 10, 15 and 20 m are available.

Rugged type cables length 0.3, 0.5, 1, 2, 3, 5, 10 and 15 m are available.

\*2. The lineup features Low Smoke Zero Halogen cables for in-cabinet use and PUR cables for out-of-cabinet use.

\*3. Cables colors are available in blue, yellow, or Green.

### ●Cables / Connectors

#### Wire Gauge and Number of Pairs: AWG24, 4-pair Cable

Item	Appearance	Recommended manufacturer	Model
Cables	—	Hitachi Metals, Ltd.	NETSTAR-C5E SAB 0.5 × 4P *
	—	Kuramo Electric Co.	KETH-SB *
	—	SWCC Showa Cable Systems Co.	FAE-5004 *
RJ45 Connectors	—	Panduit Corporation	MPS588-C *

\* We recommend you to use above cable and connector together.



#### Wire Gauge and Number of Pairs: AWG22, 2-pair Cable

Item	Appearance	Recommended manufacturer	Model
Cables	—	Kuramo Electric Co.	KETH-PSB-OMR *
	—	JMACS Japan Co.,Ltd.	PNET/B *
RJ45 Assembly Connector		OMRON	XS6G-T421-1 *

**Note:** Connect both ends of cable shielded wires to the connector hoods.



\* We recommend you to use above cable and connector together.

### ●Industrial switching hubs for Ethernet

Appearance	Number of ports	Failure detection	Current consumption	Model
	3	None	0.22A	W4S1-03B
	5	None	0.22A	W4S1-05B
		Supported		W4S1-05C

**Note:** Industrial switching hubs are cannot be used for EtherCAT.

### ●EtherCAT junction slaves

Appearance	Number of ports	Power supply voltage	Current consumption	Model
	3	20.4 to 28.8 VDC (24 VDC -15 to 20%)	0.08A	GX-JC03
	6		0.17A	GX-JC06

**Note:** 1. Please do not connect EtherCAT junction slave with OMRON position control unit, Model CJ1W-NC□81/□82.  
2. EtherCAT junction slaves cannot be used for EtherNet/IP™ and Ethernet.

# Specifications

## ● Sensor Head

Item	ZW-S07	ZW-S20	ZW-S30	ZW-S40	ZW-SR07	ZW-SR20	ZW-SR40
Measuring center distance	7 mm	20 mm	30 mm	40 mm	7 mm	20 mm	40 mm
Measuring range	±0.3 mm	±1 mm	±3 mm	±6 mm	±0.3 mm	±1 mm	±6 mm
Static resolution *1	0.25 μm	0.25 μm	0.25 μm	0.25 μm	0.25 μm	0.25 μm	0.25 μm
Linearity *2	±0.8 μm	±1.2 μm	±4.5 μm	±7.0 μm	±1.1 μm	±1.6 μm	±9.3 μm
Spot diameter *3	Near	20 μm dia.	45 μm dia.	70 μm dia.	90 μm dia.	20 μm dia.	45 μm dia.
	Center	18 μm dia.	40 μm dia.	60 μm dia.	80 μm dia.	18 μm dia.	40 μm dia.
	Far	20 μm dia.	45 μm dia.	70 μm dia.	90 μm dia.	20 μm dia.	45 μm dia.
Measuring cycle	500 μs to 10 ms						
Applicable sensor controller	ZW-C1□□□/-CE1□□						
Operating ambient illumination	Illumination on object surface 10,000 lx or less: incandescent light						
Ambient temperature range	Operating: 0 to 50°C, Storage: -15 to 60°C (with no icing or condensation)						
Ambient humidity range	Operating and storage: 35% to 85% (with no condensation)						
Degree of protection	IP40 (IEC60529)						
Vibration resistance (destructive)	10 to 150 Hz, 0.35 mm single amplitude, 80 min each in X, Y, and Z directions						
Shock resistance (destructive)	150 m/s <sup>2</sup> 3 times each in six directions (up/down, left/right, forward/backward)						
Temperature characteristic *4	0.6 μm/°C	1.5 μm/°C	2.8 μm/°C	4.8 μm/°C	0.6 μm/°C	1.5 μm/°C	4.8 μm/°C
Materials	Case: aluminum die-cast Fiber cable sheath: PVC Calibration ROM: PC						
Fiber cable length	0.3 m, 2 m (Flex-resistant cable)						
Fiber cable minimum bending radius	20 mm						
Insulation resistance (Calibration ROM)	Between case and all terminals: 20 MΩ (by 250 V megger)						
Dielectric strength (Calibration ROM)	Between case and all terminals: 1,000 VAC, 50/60 Hz, 1 min						
Weight	Approx. 105 g (Chassis, fiber cable total)						
Accessories included with sensor head	Fixing screw (M2) for Calibration ROM, Strap × 1, Instruction sheet, Precautions for correct use						

\*1. Capacity value when Omron standard mirror surface target is measured at the measurement center distance as the average of 4,096 times.

\*2. Material setting for the Omron standard mirror surface target: Error from an ideal straight line when measuring on mirror surface.

The reference values for linearity when targets to measure other than the above are as in the table below.

Item	ZW-S07	ZW-S20	ZW-S30	ZW-S40	ZW-SR07	ZW-SR20	ZW-SR40
Glass	±1.0 μm	±1.2 μm	±4.5 μm	±7.0 μm	±1.1 μm	±1.6 μm	±9.3 μm
SUS BA	±1.2 μm	±1.4 μm	±5.5 μm	±8.5 μm	±1.2 μm	±1.8 μm	±9.3 μm
White ceramic	±1.6 μm	±1.7 μm	±6.4 μm	±9.5 μm	±1.6 μm	±1.9 μm	±11.0 μm

\*3. Capacity value defined by  $1/e^2$  (13.5%) of the center optical intensity in the measured area.

\*4. Temperature characteristic at the measurement center distance when the Sensor Head and the target are fastened with an aluminum jig and the Sensor Head and the Controller are set in the same temperature environment.

## ● Automation Software Sysmac Studio

### System Requirements

Item	Requirement
Operating system (OS) *1 *2	Windows XP (Service Pack 3 or higher, 32-bit version)/Windows Vista (32-bit version)/Windows 7 (32-bit/64-bit version)/Windows 8 (32-bit/64-bit version)/Windows 8.1 (32-bit/64-bit version)/Windows 10 (32-bit/64-bit version)
CPU	Windows computers with Celeron 540 (1.8 GHz) or faster CPU. Core i5 M520 (2.4 GHz) or equivalent or faster recommended
Main memory	2 GB min.
Recommended videomemory / video card for using 3D motion trace	Video memory: 512 MB min. Video card: Either of the following video cards: • NVIDIA GeForceR 200 Series or higher • ATI RadeonHD5000 Series or higher
Hard disk	At least 1.6 GB of available space
Display	XGA 1024 × 768, 16 million colors. WXGA 1280 × 800 min. recommended
Disk drive	DVD-ROM drive
Communications ports	USB port corresponded to USB 2.0, or Ethernet port *3
Supported languages	Japanese, English, German, French, Italian, Spanish, simplified Chinese, traditional Chinese, Korean

\*1. Sysmac Studio Operating System Precaution: System requirements and hard disk space may vary with the system environment.

\*2. The following restrictions apply when Sysmac Studio is used with Microsoft Windows Vista or Windows 7.

Some Help files cannot be accessed.

The Help files can be accessed if the Help program distributed by Microsoft for Windows (WinHlp32.exe) is installed. Refer to the Microsoft homepage listed below or contact Microsoft for details on installing the file. (The download page is automatically displayed if the Help files are opened while the user is connected to the Internet.)  
<http://support.microsoft.com/kb/917607/en-us>

\*3. Refer to the hardware manual for your Controller for hardware connection methods and cables to connect the computer and Controller.

## ● Setting Software Smart Monitor ZW ZW-SW101

### System Requirements

Item	Condition
Operating System(OS)	Windows 7 (32 or 64-bit version) Windows XP (Service Pack3 or more, 32-bit version)
CPU	Intel Pentium III, 850 MHz or more (2 GHz or more is recommended.)
Main memory	1 GB or more
Hard disk	50 MB or more
Display	1024 × 768 dots or more, 16 million colors or more
Supported languages	Japanese/English
Communication port	Ethernet port

## ● Controller

Item	ZW-CE10T	ZW-CE15T	
Input/Output type	NPN	PNP	
Number of connected Sensor Heads	1 per Controller		
Applicable sensor head	ZW-S□□/SR□□		
Light source for measurement	White LED		
Segment display	Main display	11-segment red display, 6 digits	
	Sub-display	11-segment green display, 6 digits	
LED display	Status indicators	HIGH (orange), PASS (green), LOW (orange), STABILITY (green), ZERO (green), ENABLE (green), THRESHOLD-H (orange), THRESHOLD-L (orange), RUN (green)	
	EtherCAT indicators	L/A IN(Link Activity IN)(green), L/O OUT(Link Activity OUT)(green), ECAT RUN(green), ECAT ERR(red)	
External interface	Ethernet	100BASE-TX, 10BASE-T, No-protocol Communications (TCP/UDP), EtherNet/IP™	
	EtherCAT	EtherCAT-specific protocol 100BASE-TX	
	RS-232C	115,200 bps max.	
	Analog output terminal block	Analog voltage output (OUT1V)	-10 V to +10 V, output impedance: 100 Ω
		Analog current output (OUT1A)	4 mA to 20 mA, maximum load resistance: 300Ω
	32-pole extension connector	Judgment output (HIGH1/PASS1/LOW1)	Transistor output system Output voltage: 21.6 to 30 VDC Load current: 50 mA or less Residual voltage when turning ON: 1.2 V or less Leakage voltage when turning OFF: 0.1 mA or less
		BUSY output (BUSY1)	DC input system Input voltage: 24 VDC ·10% (21.6 to 26.4 VDC) Input current: 7 mA Typ. (24 VDC)
		ALARM output (ALARM1)	Voltage/Current when turning ON: 19 V/3 mA or more Voltage/Current when turning OFF:5 V/1 mA or less
		ENABLE output (ENABLE)	DC input system Input voltage: 24 VDC ·10% (21.6 to 26.4 VDC) Input current: 7 mA Typ. (24 VDC)
		LED OFF input (LED OFF1)	Voltage/Current when turning ON: 19 V/3 mA or more Voltage/Current when turning OFF:5 V/1 mA or less
		ZERO RESET input (ZERO)	DC input system Input voltage: 21.6 to 26 VDC Input current: 7 mA Typ. (24 VDC)
		TIMING output (TIMING1)	Voltage/Current when turning ON: 19 V/3 mA or more Voltage/Current when turning OFF:5 V/1 mA or less
Bank	Selected bank output (BANK_OUT 1 to 3)	Transistor output system Output voltage: 21.6 to 30 VDC Load current: 50 mA or less Residual voltage when turning ON: 1.2 V or less Leakage voltage when turning OFF: 0.1 mA or less	
	Selected bank input (BANK_SEL 1 to 3)	DC input system Input voltage: 21.6 to 26 VDC Input current: 7 mA Typ. (24 VDC) Voltage/Current when turning ON: 19 V/3 mA or more Voltage/Current when turning OFF:5 V/1 mA or less	
Main functions	Exposure time	Auto/Manual	
	Measuring cycle	500 μs to 10 ms	
	Material setting	Standard/Mirror/Diffusion surfaces	
	Measurement item	Height/Thickness/Calculation	
	Filtering	Median/Average/Differentiation/High pass/Low pass/Band pass	
	Outputs	Scaling/Different holds/Zero reset/Logging for a measured value	
	Display	Measured value/Threshold value/Analog output voltage or current value/Judgment result/Resolution/Exposure time	
	Number of configurable banks	Max. 8 banks	
	Task process	Multi-task (up to 4 tasks per bank)	
Ratings	System	Save/Initialization/Display measurement information/Communication settings/Sensor Head calibration/Key-lock/Trigger-key input	
	Power supply voltage	21.6 to 26.4 VDC (including ripple)	
	Current consumption	600 mA max.	
	Insulation resistance	Across all lead wires and controller case: 20 MΩ(by 250 V megger)	
Environmental	Dialectic strength	Across all lead wires and controller case: 1,000 VAC, 50/60 Hz, 1 min.	
	Degree of protection	IP20(IEC60529)	
	Vibration resistance (destructive)	10 to 55 Hz, 0.35-mm single amplitude, 50 min each in X, Y, and Z directions	
	Shock resistance (destructive)	150 m/s <sup>2</sup> , 3 times each in six directions (up/down, left/right, forward/backward)	
	Ambient temperature	Operating: 0 to 40°C Storage:-15 to 60°C (with no icing or condensation)	
	Ambient humidity	Operating and storage: 35% to 85% (with no condensation)	
Grounding	D-type grounding (Grounding resistance of 100 Ω or less) Note: For conventional Class D grounding		
Materials	Case: PC		
Weight	Approx. 750 g (main unit only), Approx. 150 g (Parallel Cable)		
Accessories included with controller	Instruction sheet,Member registration sheet, Parallel cable ZW-XCP2E		

Note: Controllers with binary outputs are also available (ZW-C10T/-C15T). Please contact your OMRON sales representative for details.

## ● ZW Series EtherCAT Communications Specifications

Item	Specification
Communications standard	IEC61158 Type12
Physical layer	100BASE-TX(IEEE802.3)
Connectors	RJ45 × 2 ECAT IN: EtherCAT input ECAT OUT: EtherCAT output
Communications media	Category 5 or higher (cable with double, aluminum tape and braided shielding) is recommended.
Communications distance	Distance between nodes: 100 m max.
Process data	Variable PDO mapping
Mailbox (CoE)	Emergency messages, SDO requests, SDO responses, and SDO information
Distributed clock	Synchronization in DC mode.
LED display	L/A IN (Link/Activity IN) × 1, AL/A OUT (Link/Activity OUT) × 1, AECAT RUN × 1, AECAT ERR × 1

# Characteristic data (typical examples)

## Linearity Characteristic by Materials

### Straight type

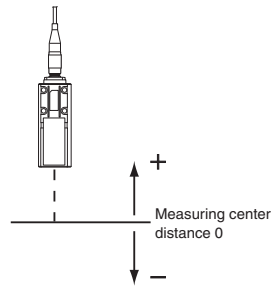

#### ZW-S07

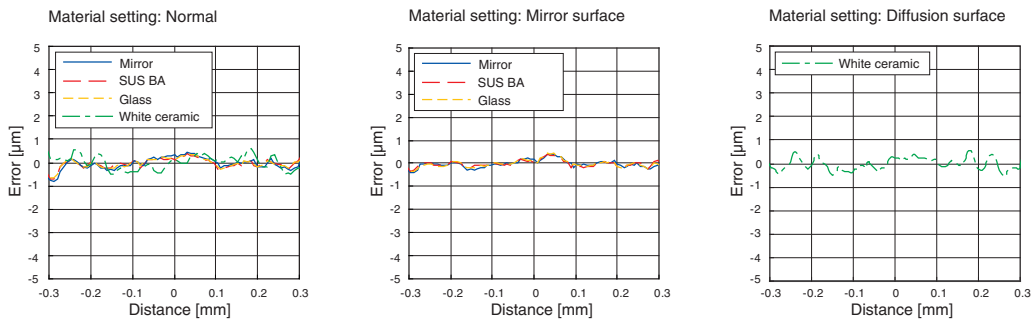

#### ZW-S20

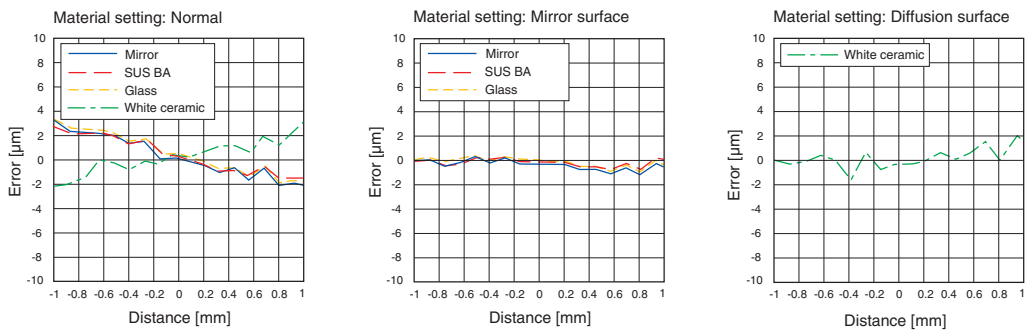

#### ZW-S30

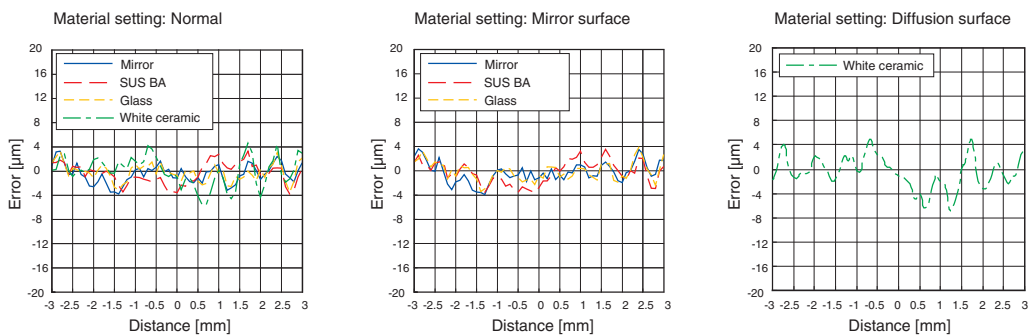

#### ZW-S40

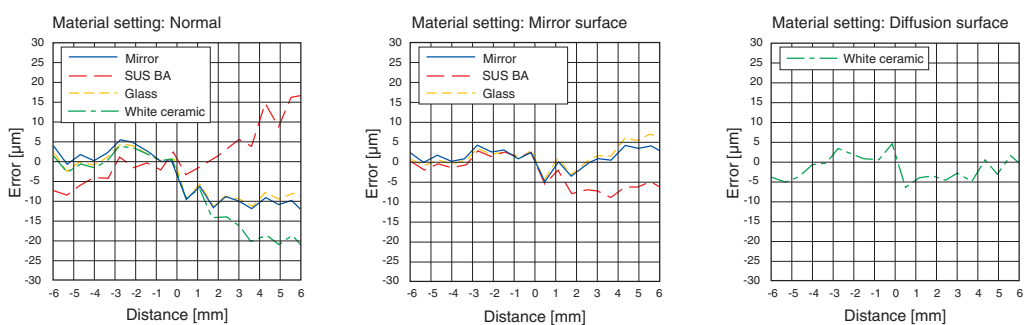

**Right-angle type**

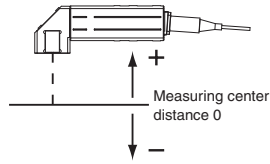

**ZW-SR07**

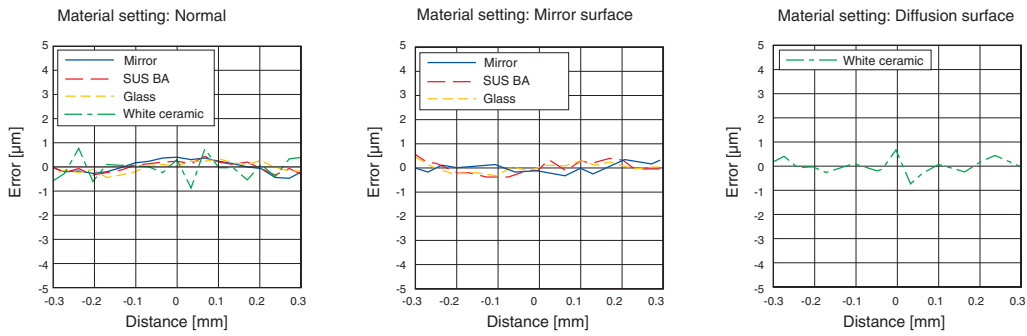

**ZW-SR20**

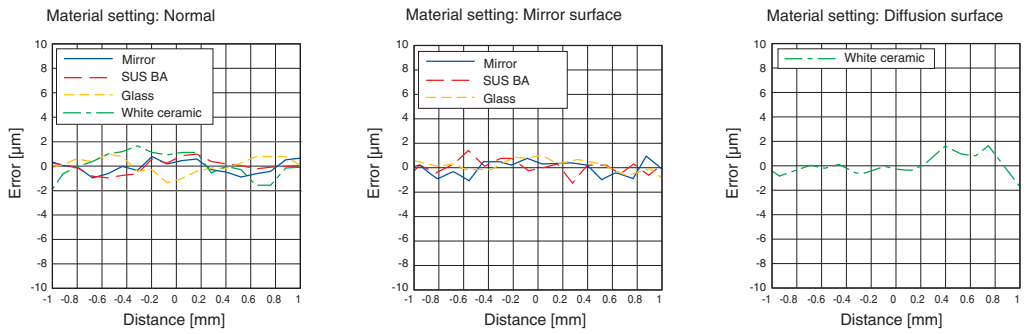

**ZW-SR40**

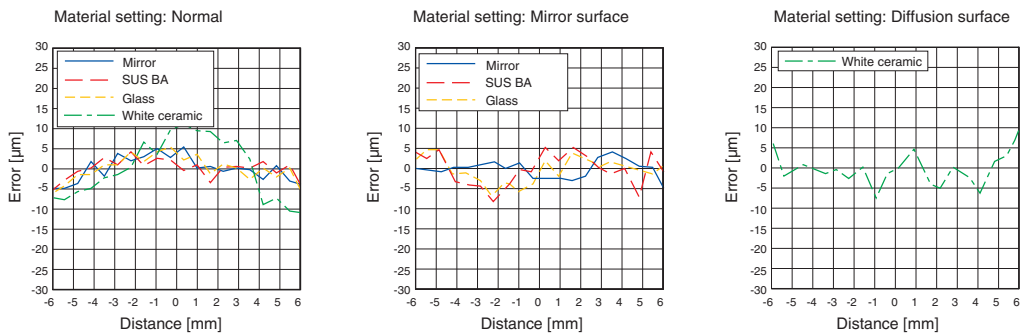

● Angle Characteristic \*  
Straight type

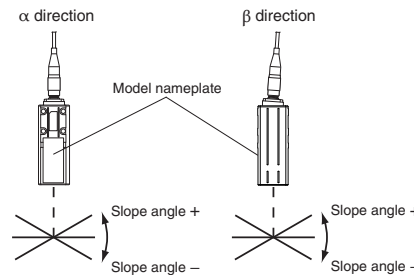

\* The above show the results after executing scaling.

ZW-S07

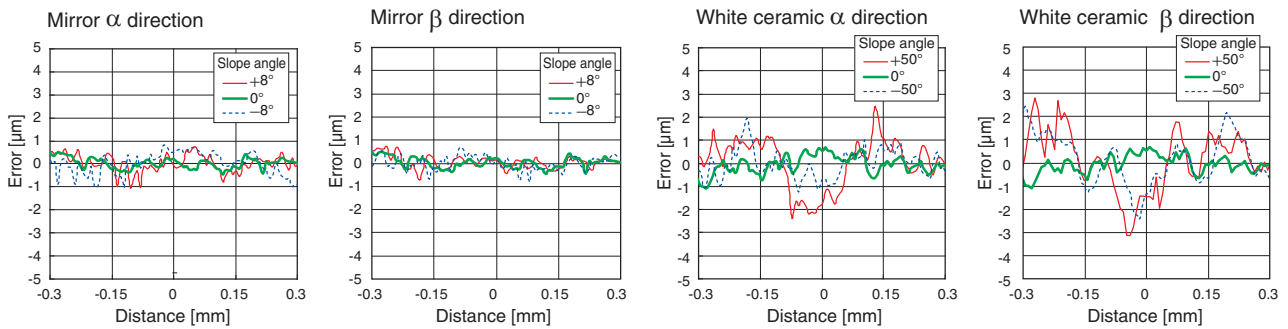

ZW-S20

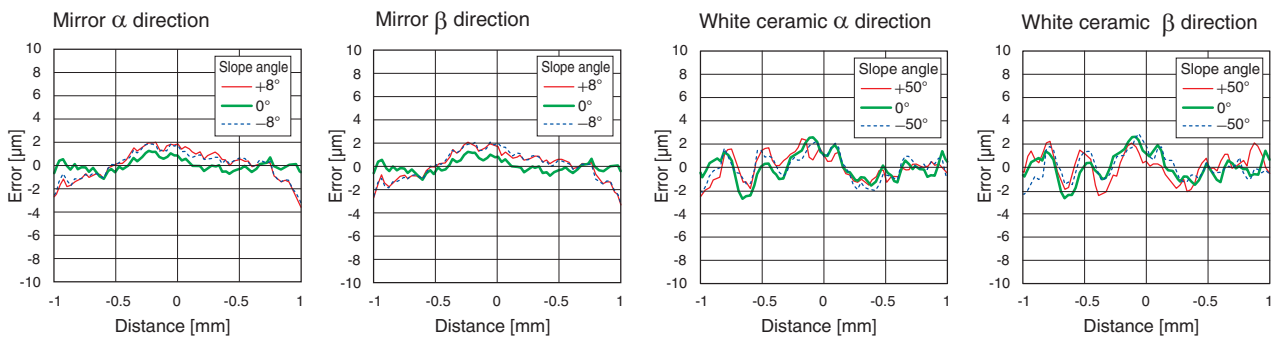

ZW-S30

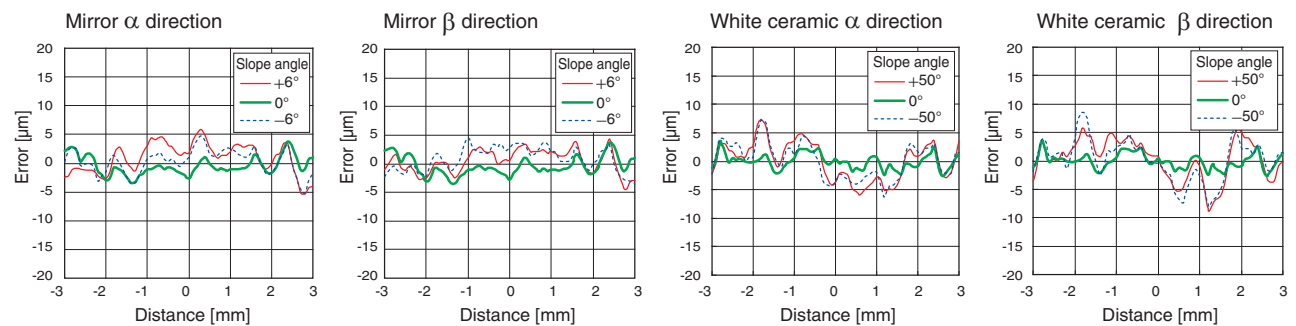

ZW-S40

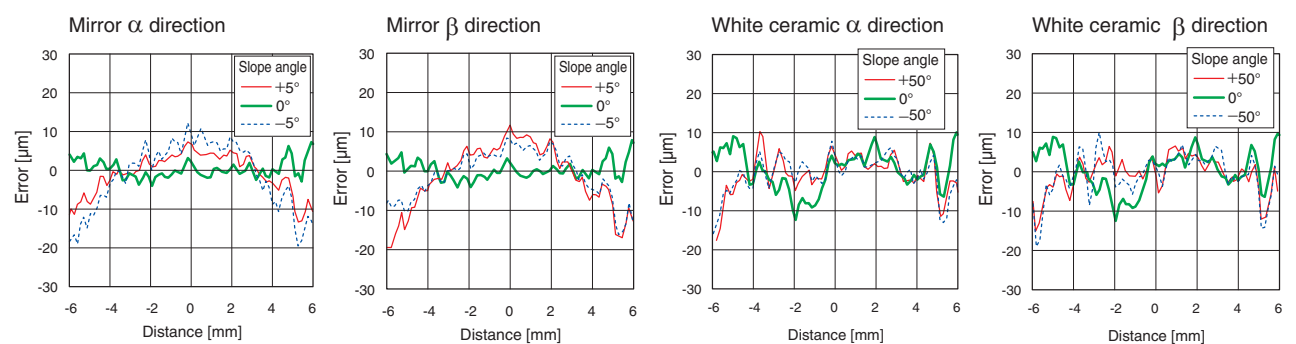

**Right-angle type**

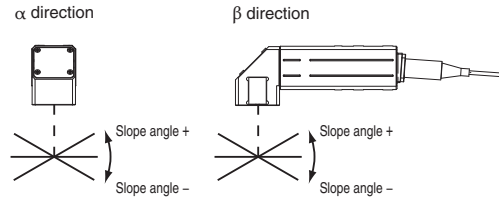

\* The above show the results after executing scaling.

**ZW-SR07**

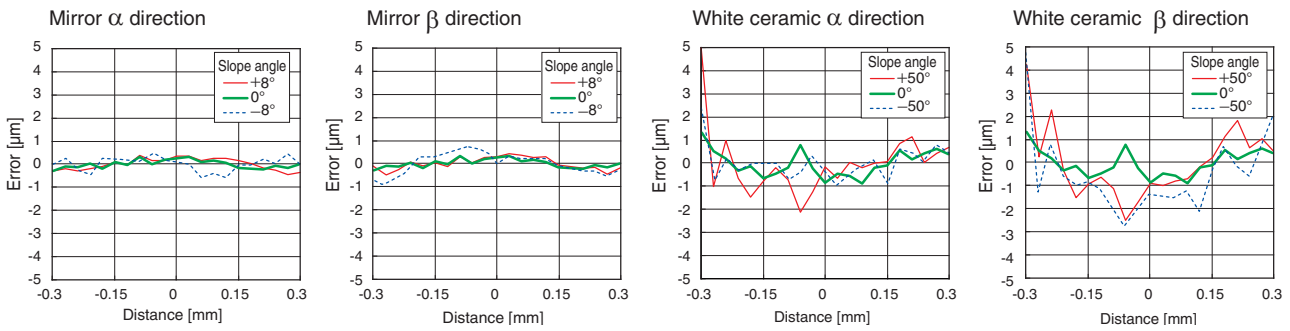

**ZW-SR20**

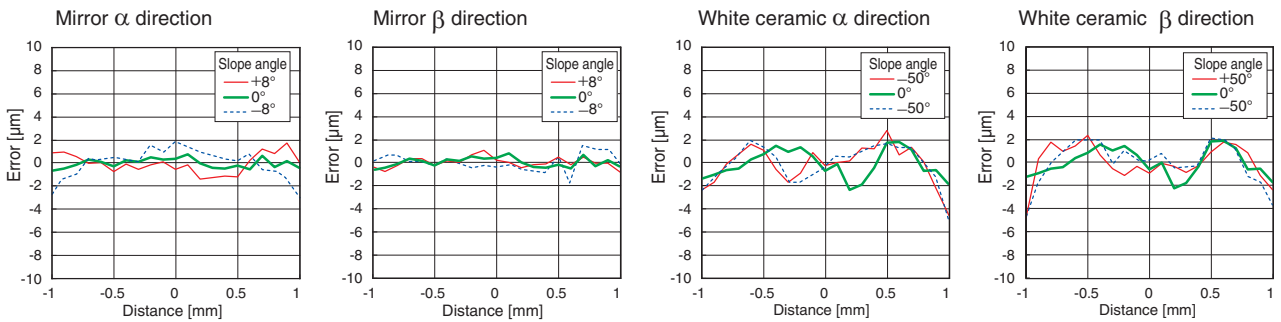

**ZW-SR40**

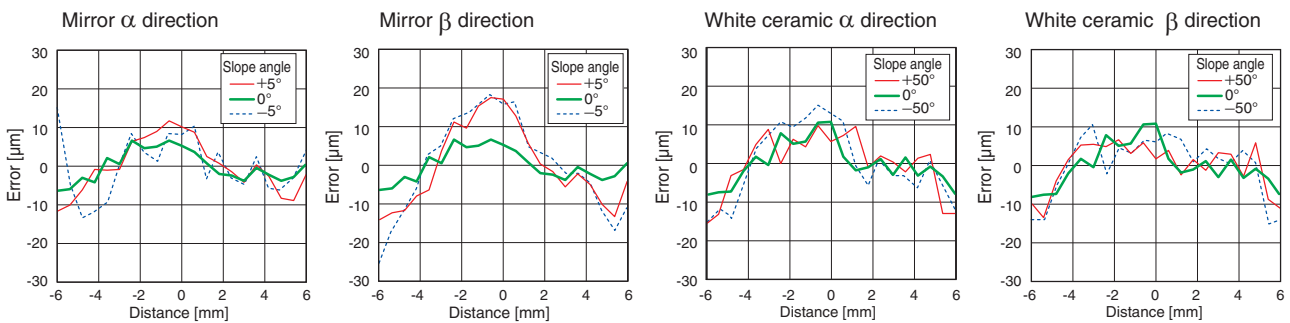



# External Dimensions

(Unit: mm)

## Sensor Head Straight type

ZW-S07/-S20/-S30/-S40

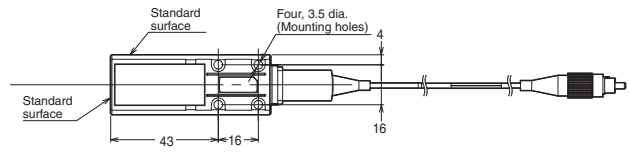
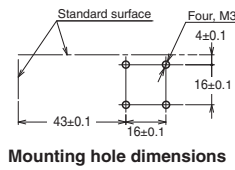

Note:

Model	L	M	X
ZW-S07	7	0.3	12
ZW-S20	20	1	11.8
ZW-S30	30	3	11.7
ZW-S40	40	6	11.7

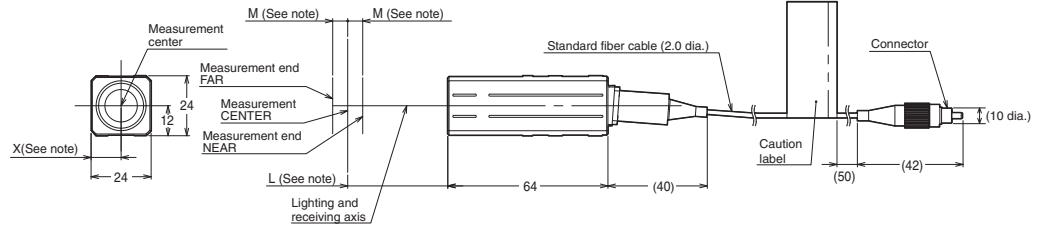

## Right-angle type

ZW-SR07/-SR20/-SR40

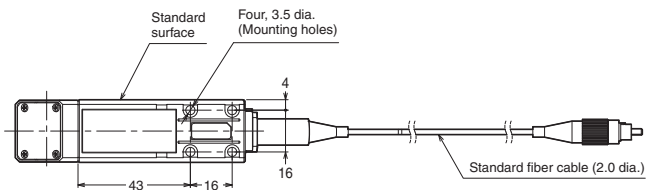
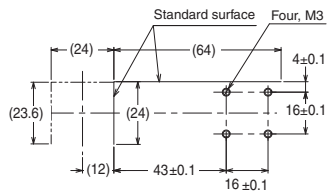

Note:

Model	L	M
ZW-SR07	7	0.3
ZW-SR20	20	1
ZW-SR40	40	6

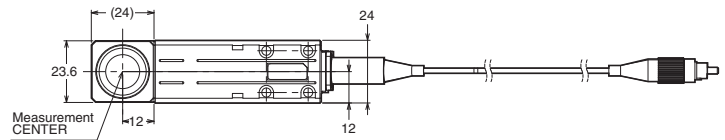
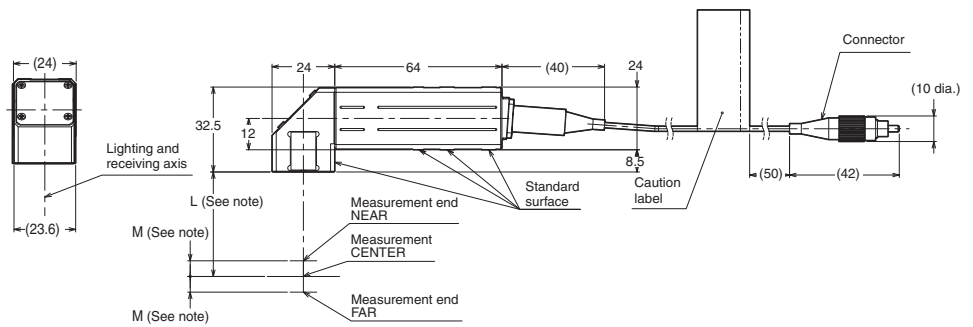

## Controller

ZW-CE10T/-CE15T

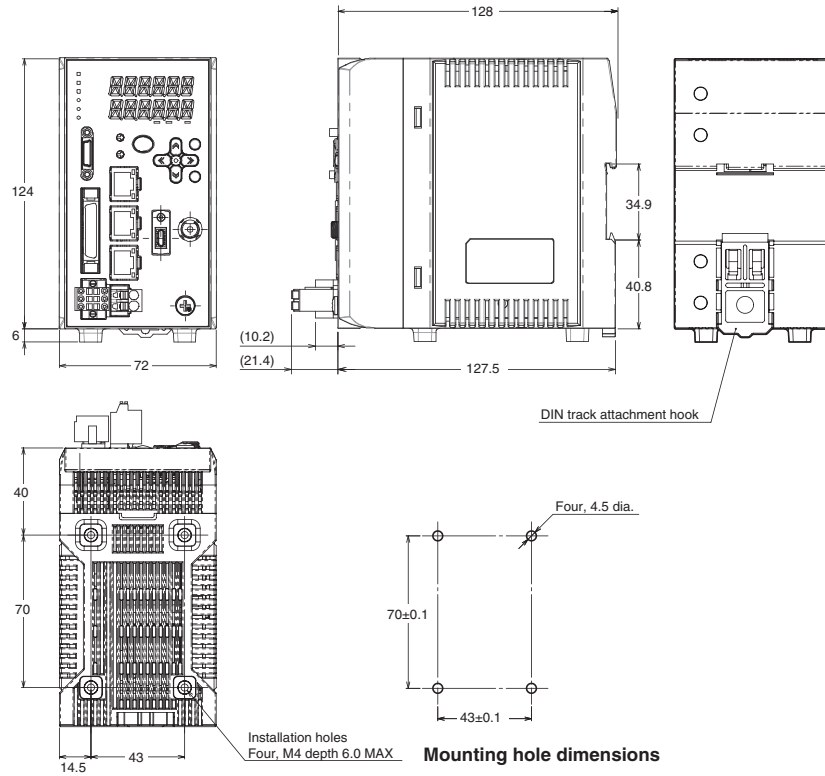

## Extension Fiber Cable

ZW-XF02R/-XF05R/-XF10R/-XF20R/-XF30R

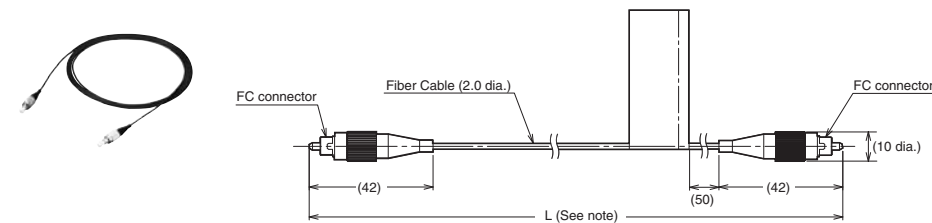

**Note:** The following table lists cable lengths per models.

Model	Cable length	L
ZW-XF02R	2 m	2,000±20
ZW-XF05R	5 m	5,000±50
ZW-XF10R	10 m	10,000±100
ZW-XF20R	20 m	20,000±200
ZW-XF30R	30 m	30,000±300

## Related Manuals

Man.No.	Model number	Manual
Z332	ZW-CE1□T	Displacement Measurement Sensor ZW-CE1□T Series User's Manual

# Terms and Conditions Agreement

## Read and understand this catalog.

Please read and understand this catalog before purchasing the products. Please consult your OMRON representative if you have any questions or comments.

## Warranties.

- (a) Exclusive Warranty. Omron's exclusive warranty is that the Products will be free from defects in materials and workmanship for a period of twelve months from the date of sale by Omron (or such other period expressed in writing by Omron). Omron disclaims all other warranties, express or implied.
- (b) Limitations. OMRON MAKES NO WARRANTY OR REPRESENTATION, EXPRESS OR IMPLIED, ABOUT NON-INFRINGEMENT, MERCHANTABILITY OR FITNESS FOR A PARTICULAR PURPOSE OF THE PRODUCTS. BUYER ACKNOWLEDGES THAT IT ALONE HAS DETERMINED THAT THE PRODUCTS WILL SUITABLY MEET THE REQUIREMENTS OF THEIR INTENDED USE.

Omron further disclaims all warranties and responsibility of any type for claims or expenses based on infringement by the Products or otherwise of any intellectual property right. (c) Buyer Remedy. Omron's sole obligation hereunder shall be, at Omron's election, to (i) replace (in the form originally shipped with Buyer responsible for labor charges for removal or replacement thereof) the non-complying Product, (ii) repair the non-complying Product, or (iii) repay or credit Buyer an amount equal to the purchase price of the non-complying Product; provided that in no event shall Omron be responsible for warranty, repair, indemnity or any other claims or expenses regarding the Products unless Omron's analysis confirms that the Products were properly handled, stored, installed and maintained and not subject to contamination, abuse, misuse or inappropriate modification. Return of any Products by Buyer must be approved in writing by Omron before shipment. Omron Companies shall not be liable for the suitability or unsuitability or the results from the use of Products in combination with any electrical or electronic components, circuits, system assemblies or any other materials or substances or environments. Any advice, recommendations or information given orally or in writing, are not to be construed as an amendment or addition to the above warranty.

See <http://www.omron.com/global/> or contact your Omron representative for published information.

## Limitation on Liability; Etc.

OMRON COMPANIES SHALL NOT BE LIABLE FOR SPECIAL, INDIRECT, INCIDENTAL, OR CONSEQUENTIAL DAMAGES, LOSS OF PROFITS OR PRODUCTION OR COMMERCIAL LOSS IN ANY WAY CONNECTED WITH THE PRODUCTS, WHETHER SUCH CLAIM IS BASED IN CONTRACT, WARRANTY, NEGLIGENCE OR STRICT LIABILITY.

Further, in no event shall liability of Omron Companies exceed the individual price of the Product on which liability is asserted.

## Suitability of Use.

Omron Companies shall not be responsible for conformity with any standards, codes or regulations which apply to the combination of the Product in the Buyer's application or use of the Product. At Buyer's request, Omron will provide applicable third party certification documents identifying ratings and limitations of use which apply to the Product. This information by itself is not sufficient for a complete determination of the suitability of the Product in combination with the end product, machine, system, or other application or use. Buyer shall be solely responsible for determining appropriateness of the particular Product with respect to Buyer's application, product or system. Buyer shall take application responsibility in all cases.

NEVER USE THE PRODUCT FOR AN APPLICATION INVOLVING SERIOUS RISK TO LIFE OR PROPERTY OR IN LARGE QUANTITIES WITHOUT ENSURING THAT THE SYSTEM AS A WHOLE HAS BEEN DESIGNED TO ADDRESS THE RISKS, AND THAT THE OMRON PRODUCT(S) IS PROPERLY RATED AND INSTALLED FOR THE INTENDED USE WITHIN THE OVERALL EQUIPMENT OR SYSTEM.

## Programmable Products.

Omron Companies shall not be responsible for the user's programming of a programmable Product, or any consequence thereof.

## Performance Data.

Data presented in Omron Company websites, catalogs and other materials is provided as a guide for the user in determining suitability and does not constitute a warranty. It may represent the result of Omron's test conditions, and the user must correlate it to actual application requirements. Actual performance is subject to the Omron's Warranty and Limitations of Liability.

## Change in Specifications.

Product specifications and accessories may be changed at any time based on improvements and other reasons. It is our practice to change part numbers when published ratings or features are changed, or when significant construction changes are made. However, some specifications of the Product may be changed without any notice. When in doubt, special part numbers may be assigned to fix or establish key specifications for your application. Please consult with your Omron's representative at any time to confirm actual specifications of purchased Product.

## Errors and Omissions.

Information presented by Omron Companies has been checked and is believed to be accurate; however, no responsibility is assumed for clerical, typographical or proofreading errors or omissions.

**OMRON Corporation Industrial Automation Company**  
Tokyo, JAPAN

Contact: [www.ia.omron.com](http://www.ia.omron.com)

**Regional Headquarters**

**OMRON EUROPE B.V.**

Wegalaan 67-69, 2132 JD Hoofddorp  
The Netherlands  
Tel: (31)2356-81-300/Fax: (31)2356-81-388

**OMRON ELECTRONICS LLC**

2895 Greenspoint Parkway, Suite 200  
Hoffman Estates, IL 60169 U.S.A  
Tel: (1) 847-843-7900/Fax: (1) 847-843-7787

**OMRON ASIA PACIFIC PTE. LTD.**

No. 438A Alexandra Road # 05-05/08 (Lobby 2),  
Alexandra Technopark,  
Singapore 119967  
Tel: (65) 6835-3011/Fax: (65) 6835-2711

**OMRON (CHINA) CO., LTD.**

Room 2211, Bank of China Tower,  
200 Yin Cheng Zhong Road,  
PuDong New Area, Shanghai, 200120, China  
Tel: (86) 21-5037-2222/Fax: (86) 21-5037-2200

**Authorized Distributor:**

© OMRON Corporation 2012-2014 All Rights Reserved.  
In the interest of product improvement,  
specifications are subject to change without notice.

CSM\_14\_2\_0218  
Cat. No. E421-E1-03

Printed in Japan  
0714 (0312)