

NGTB50N60FL2WG

IGBT - Field Stop II

This Insulated Gate Bipolar Transistor (IGBT) features a robust and cost effective Field Stop II Trench construction, and provides superior performance in demanding switching applications, offering both low on state voltage and minimal switching loss. The IGBT is well suited for UPS and solar applications. Incorporated into the device is a soft and fast co-packaged free wheeling diode with a low forward voltage.

Features

- Extremely Efficient Trench with Field Stop Technology
- $T_{Jmax} = 175^{\circ}C$
- Soft Fast Reverse Recovery Diode
- Optimized for High Speed Switching
- 5 μs Short-Circuit Capability
- This is a Pb-Free Device

Typical Applications

- Solar Inverters
- Uninterruptible Power Supplies (UPS)
- Welding

ABSOLUTE MAXIMUM RATINGS

| Rating | Symbol | Value | Unit |
|--|-----------|-------------|-------------|
| Collector-emitter voltage | V_{CES} | 600 | V |
| Collector current @ $T_C = 25^{\circ}C$ @ $T_C = 100^{\circ}C$ | I_C | 100 50 | A |
| Diode Forward Current @ $T_C = 25^{\circ}C$ @ $T_C = 100^{\circ}C$ | I_F | 100 50 | A |
| Diode Pulsed Current T_{PULSE} Limited by T_J Max | I_{FM} | 200 | A |
| Pulsed collector current, T_{pulse} limited by T_{Jmax} | I_{CM} | 200 | A |
| Short-circuit withstand time $V_{GE} = 15 V$, $V_{CE} = 400 V$, $T_J \leq +150^{\circ}C$ | t_{SC} | 5 | μs |
| Gate-emitter voltage | V_{GE} | ± 20 | V |
| Transient gate-emitter voltage ($T_{PULSE} = 5 \mu s$, $D < 0.10$) | | ± 30 | V |
| Power Dissipation @ $T_C = 25^{\circ}C$ @ $T_C = 100^{\circ}C$ | P_D | 417 208 | W |
| Operating junction temperature range | T_J | -55 to +175 | $^{\circ}C$ |
| Storage temperature range | T_{stg} | -55 to +175 | $^{\circ}C$ |
| Lead temperature for soldering, 1/8" from case for 5 seconds | T_{SLD} | 260 | $^{\circ}C$ |

Stresses exceeding those listed in the Maximum Ratings table may damage the device. If any of these limits are exceeded, device functionality should not be assumed, damage may occur and reliability may be affected.



ON Semiconductor®

www.onsemi.com

50 A, 600 V
 $V_{CEsat} = 1.80 V$
 $E_{OFF} = 0.46 mJ$

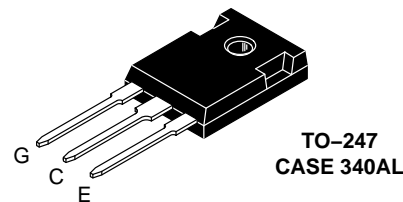
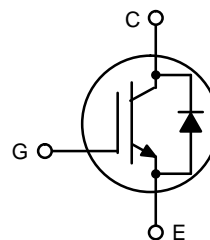

MARKING DIAGRAM



A = Assembly Location
Y = Year
WW = Work Week
G = Pb-Free Package

ORDERING INFORMATION

| Device | Package | Shipping |
|----------------|---------------------|-----------------|
| NGTB50N60FL2WG | TO-247 (Pb-Free) | 30 Units / Rail |

NGTB50N60FL2WG

THERMAL CHARACTERISTICS

| Rating | Symbol | Value | Unit |
|--|-----------------|-------|-----------------------------|
| Thermal resistance junction-to-case, for IGBT | $R_{\theta JC}$ | 0.36 | $^{\circ}\text{C}/\text{W}$ |
| Thermal resistance junction-to-case, for Diode | $R_{\theta JC}$ | 0.60 | $^{\circ}\text{C}/\text{W}$ |
| Thermal resistance junction-to-ambient | $R_{\theta JA}$ | 40 | $^{\circ}\text{C}/\text{W}$ |

ELECTRICAL CHARACTERISTICS ($T_J = 25^{\circ}\text{C}$ unless otherwise specified)

| Parameter | Test Conditions | Symbol | Min | Typ | Max | Unit |
|-----------|-----------------|--------|-----|-----|-----|------|
|-----------|-----------------|--------|-----|-----|-----|------|

STATIC CHARACTERISTIC

| | | | | | | |
|---|---|---------------|-----------|--------------|------------|----|
| Collector-emitter breakdown voltage, gate-emitter short-circuited | $V_{GE} = 0\text{ V}, I_C = 500\ \mu\text{A}$ | $V_{(BR)CES}$ | 600 | – | – | V |
| Collector-emitter saturation voltage | $V_{GE} = 15\text{ V}, I_C = 50\text{ A}$ $V_{GE} = 15\text{ V}, I_C = 50\text{ A}, T_J = 175^{\circ}\text{C}$ | V_{CEsat} | 1.50 – | 1.80 2.19 | 2.00 – | V |
| Gate-emitter threshold voltage | $V_{GE} = V_{CE}, I_C = 350\ \mu\text{A}$ | $V_{GE(th)}$ | 4.5 | 5.5 | 6.5 | V |
| Collector-emitter cut-off current, gate-emitter short-circuited | $V_{GE} = 0\text{ V}, V_{CE} = 600\text{ V}$ $V_{GE} = 0\text{ V}, V_{CE} = 600\text{ V}, T_J = 150^{\circ}\text{C}$ | I_{CES} | – | – | 0.5 4.0 | mA |
| Gate leakage current, collector-emitter short-circuited | $V_{GE} = 20\text{ V}, V_{CE} = 0\text{ V}$ | I_{GES} | – | – | 200 | nA |

DYNAMIC CHARACTERISTIC

| | | | | | | |
|------------------------------|--|-----------|---|------|---|----|
| Input capacitance | $V_{CE} = 20\text{ V}, V_{GE} = 0\text{ V}, f = 1\text{ MHz}$ | C_{ies} | – | 5328 | – | pF |
| Output capacitance | | C_{oes} | – | 252 | – | |
| Reverse transfer capacitance | | C_{res} | – | 148 | – | |
| Gate charge total | $V_{CE} = 480\text{ V}, I_C = 50\text{ A}, V_{GE} = 15\text{ V}$ | Q_g | – | 220 | – | nC |
| Gate to emitter charge | | Q_{ge} | – | 52 | – | |
| Gate to collector charge | | Q_{gc} | – | 116 | – | |

SWITCHING CHARACTERISTIC, INDUCTIVE LOAD

| | | | | | | | | |
|-------------------------|---|--|--------------|------|------|----|----|----|
| Turn-on delay time | $T_J = 25^{\circ}\text{C}$ $V_{CC} = 400\text{ V}, I_C = 50\text{ A}$ $R_g = 10\ \Omega$ $V_{GE} = 0\text{ V}/15\text{ V}$ | $t_{d(on)}$ | – | 100 | – | ns | | |
| Rise time | | t_r | – | 47 | – | | | |
| Turn-off delay time | | $t_{d(off)}$ | – | 237 | – | | | |
| Fall time | | t_f | – | 67 | – | | | |
| Turn-on switching loss | | $T_J = 150^{\circ}\text{C}$ $V_{CC} = 400\text{ V}, I_C = 50\text{ A}$ $R_g = 10\ \Omega$ $V_{GE} = 0\text{ V}/15\text{ V}$ | E_{on} | – | 1.50 | – | mJ | |
| Turn-off switching loss | | | E_{off} | – | 0.46 | – | | |
| Total switching loss | | | E_{ts} | – | 1.96 | – | | |
| Turn-on delay time | | | $t_{d(on)}$ | – | 90 | – | | ns |
| Rise time | | | t_r | – | 49 | – | | |
| Turn-off delay time | | | $t_{d(off)}$ | – | 245 | – | | |
| Fall time | t_f | – | 96 | – | | | | |
| Turn-on switching loss | $T_J = 175^{\circ}\text{C}$ $I_F = 50\text{ A}, V_R = 400\text{ V}$ $di_F/dt = 200\text{ A}/\mu\text{s}$ | E_{on} | – | 1.90 | – | mJ | | |
| Turn-off switching loss | | E_{off} | – | 0.83 | – | | | |
| Total switching loss | | E_{ts} | – | 2.73 | – | | | |

DIODE CHARACTERISTIC

| | | | | | | |
|--------------------------|---|-----------|---|--------------|-----------|---------------|
| Forward voltage | $V_{GE} = 0\text{ V}, I_F = 50\text{ A}$ $V_{GE} = 0\text{ V}, I_F = 50\text{ A}, T_J = 175^{\circ}\text{C}$ | V_F | – | 2.10 2.20 | 2.90 – | V |
| Reverse recovery time | $T_J = 25^{\circ}\text{C}$ $I_F = 50\text{ A}, V_R = 400\text{ V}$ $di_F/dt = 200\text{ A}/\mu\text{s}$ | t_{rr} | – | 94 | – | ns |
| Reverse recovery charge | | Q_{rr} | – | 0.45 | – | μC |
| Reverse recovery current | | I_{rrm} | – | 8 | – | A |
| Reverse recovery time | $T_J = 175^{\circ}\text{C}$ $I_F = 50\text{ A}, V_R = 400\text{ V}$ $di_F/dt = 200\text{ A}/\mu\text{s}$ | t_{rr} | – | 170 | – | ns |
| Reverse recovery charge | | Q_{rr} | – | 1.40 | – | μC |
| Reverse recovery current | | I_{rrm} | – | 13 | – | A |

Product parametric performance is indicated in the Electrical Characteristics for the listed test conditions, unless otherwise noted. Product performance may not be indicated by the Electrical Characteristics if operated under different conditions.

NGTB50N60FL2WG

TYPICAL CHARACTERISTICS

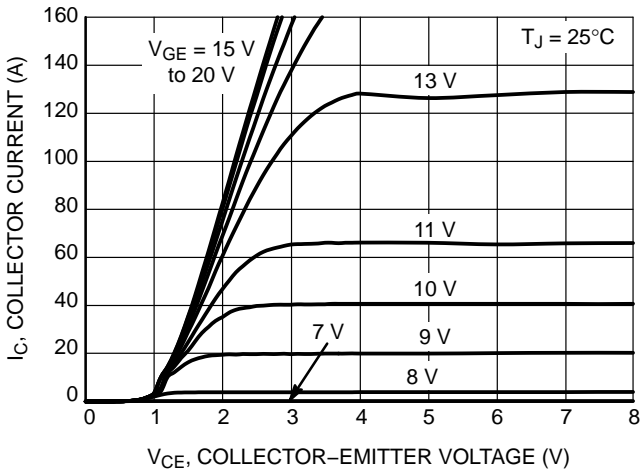

Figure 1. Output Characteristics

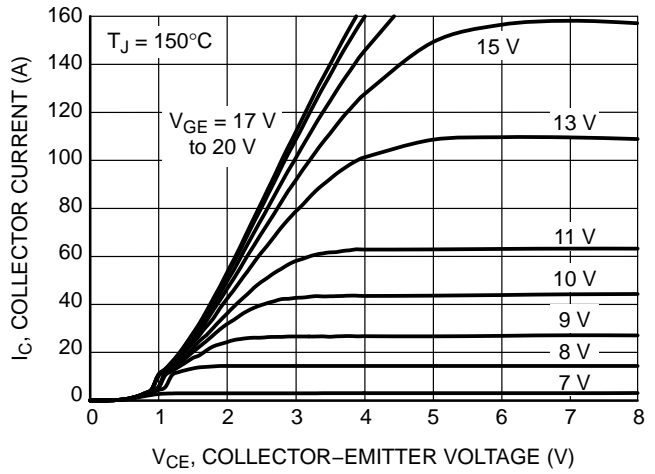

Figure 2. Output Characteristics

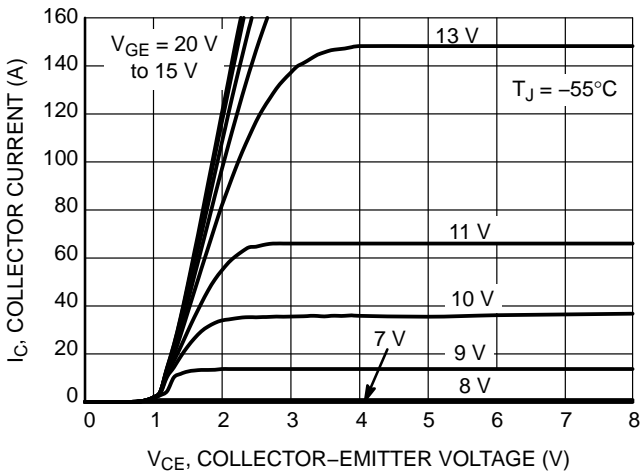

Figure 3. Output Characteristics

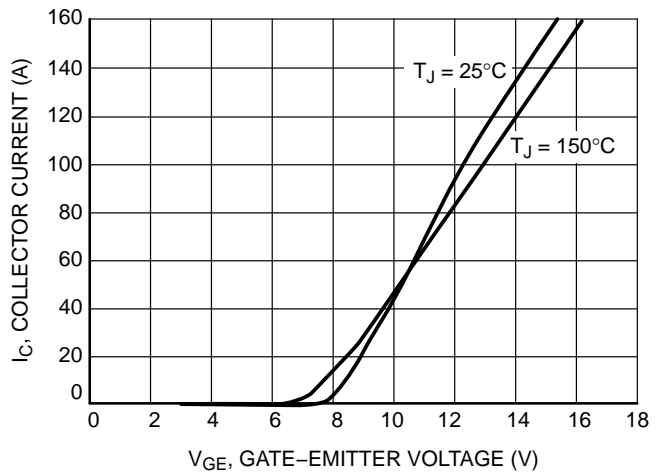

Figure 4. Typical Transfer Characteristics

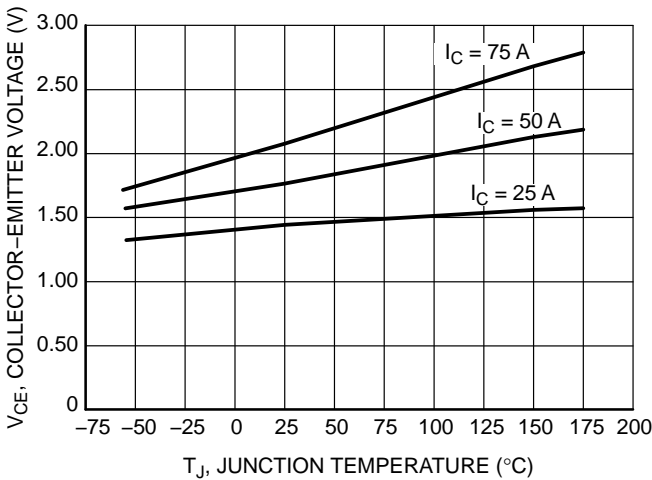

Figure 5. $V_{CE(sat)}$ vs. T_J

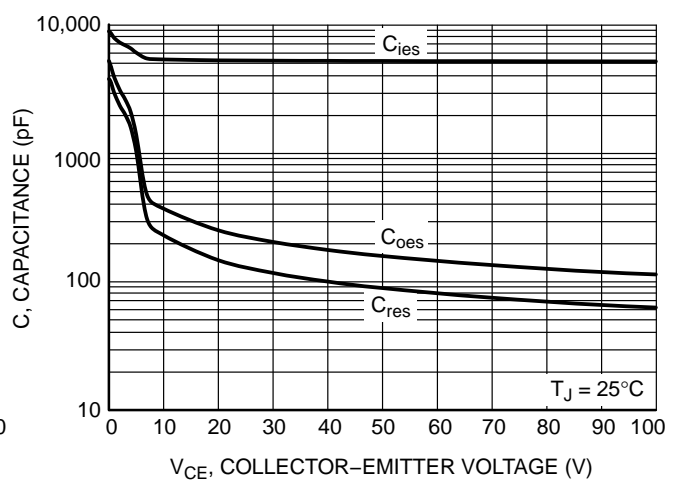

Figure 6. Typical Capacitance

NGTB50N60FL2WG

TYPICAL CHARACTERISTICS

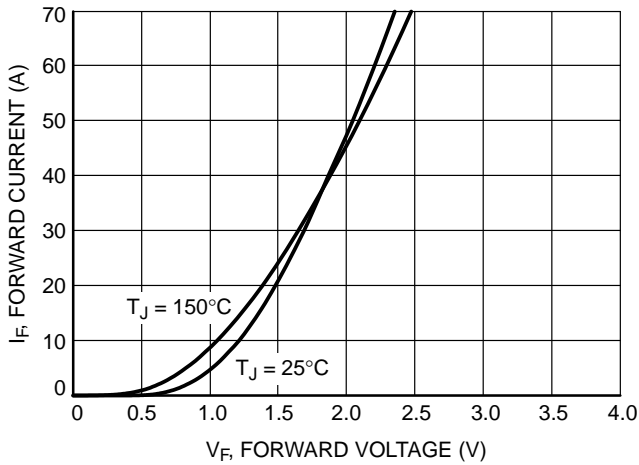

Figure 7. Diode Forward Characteristics

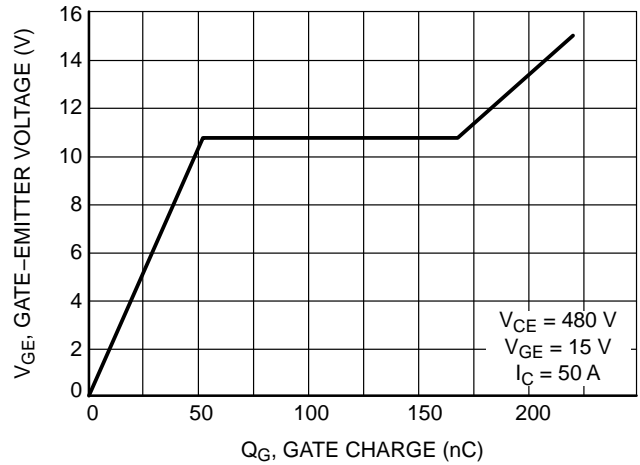

Figure 8. Typical Gate Charge

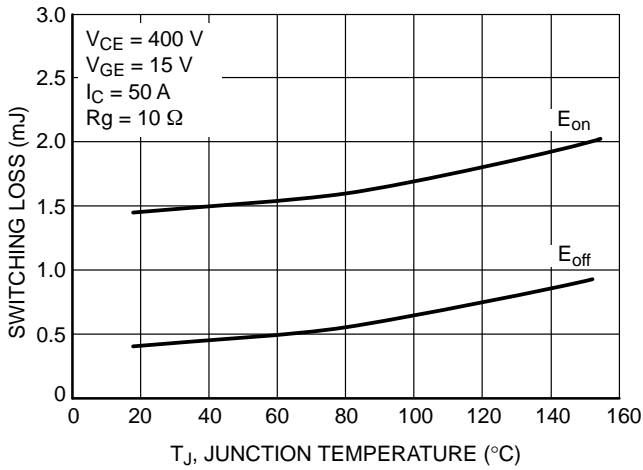

Figure 9. Switching Loss vs. Temperature

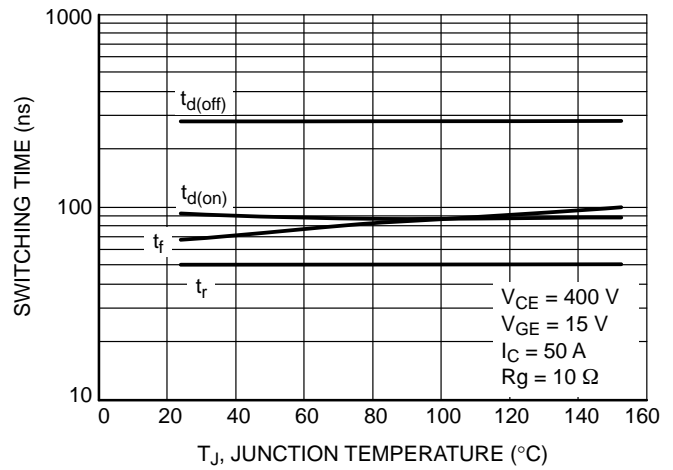

Figure 10. Switching Time vs. Temperature

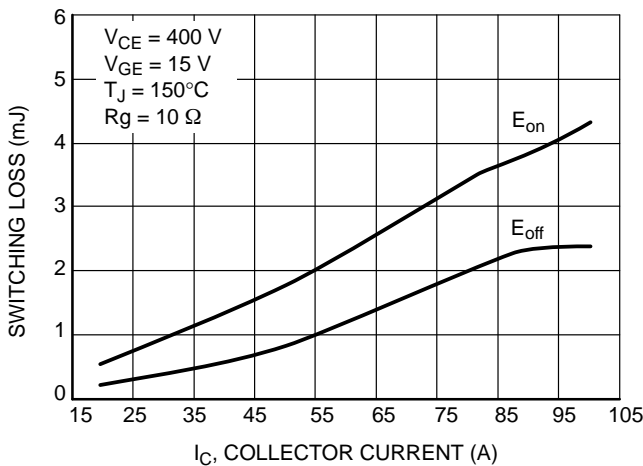

Figure 11. Switching Loss vs. I_C

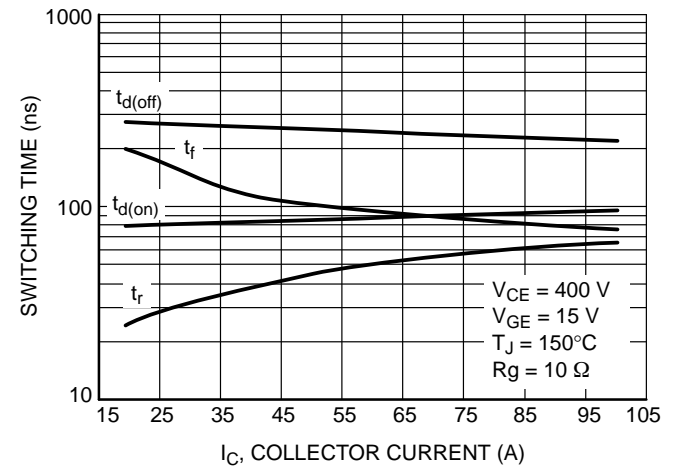

Figure 12. Switching Time vs. I_C

NGTB50N60FL2WG

TYPICAL CHARACTERISTICS

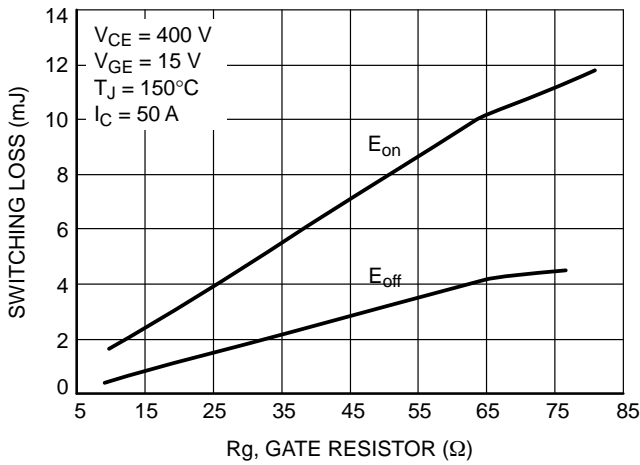

Figure 13. Switching Loss vs. R_g

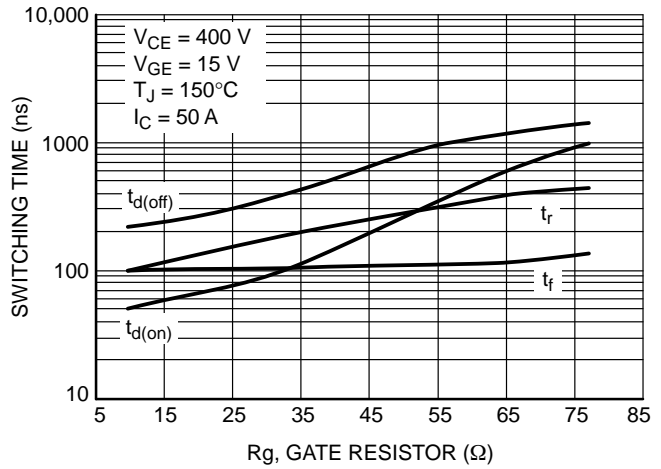

Figure 14. Switching Time vs. R_g

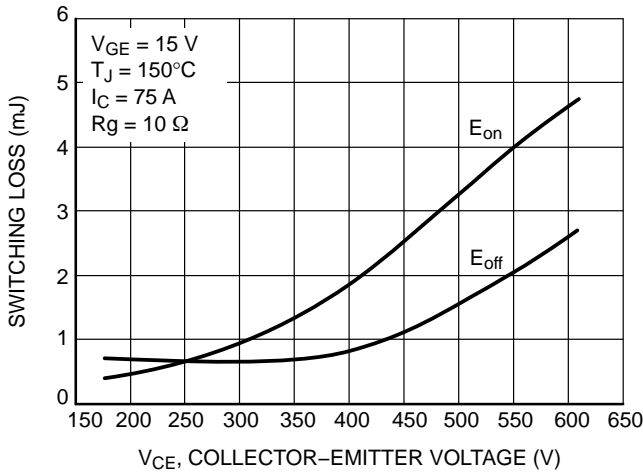

Figure 15. Switching Loss vs. V_{CE}

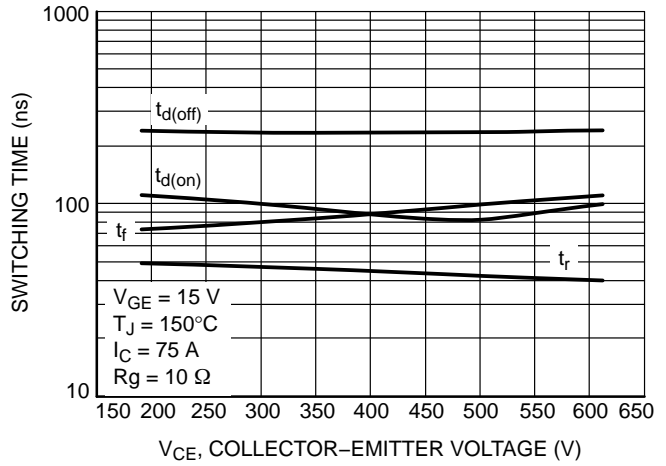

Figure 16. Switching Time vs. V_{CE}

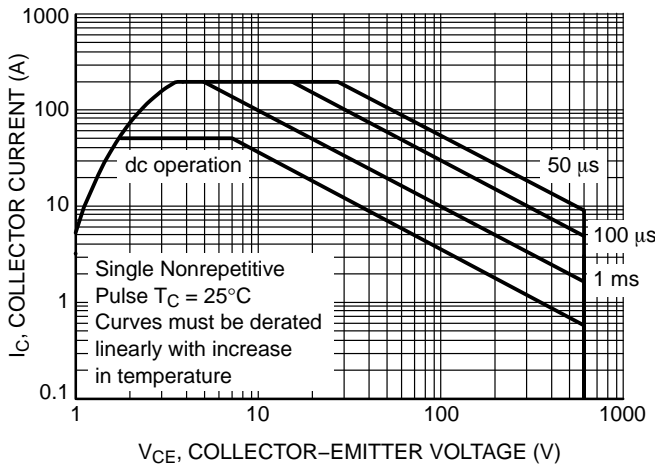

Figure 17. Safe Operating Area

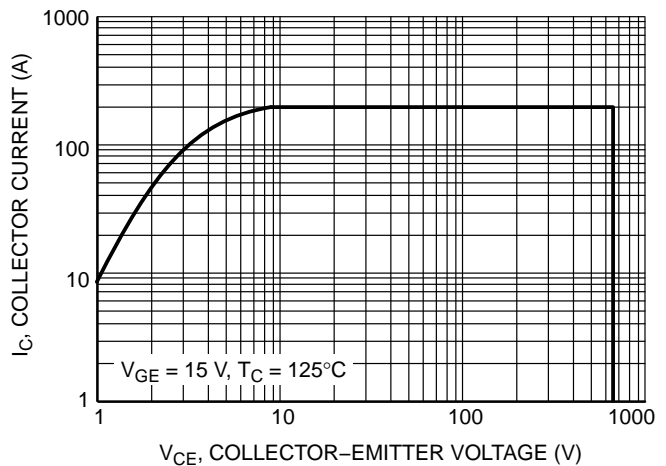

Figure 18. Reverse Bias Safe Operating Area

NGTB50N60FL2WG

TYPICAL CHARACTERISTICS

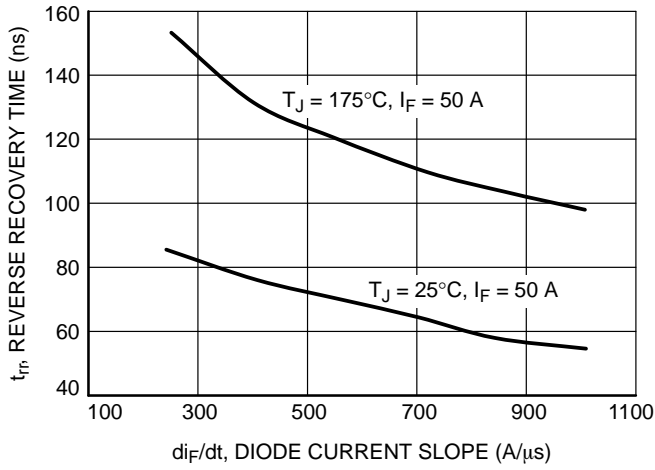

Figure 19. t_{rr} vs. di_F/dt
($V_R = 400$ V)

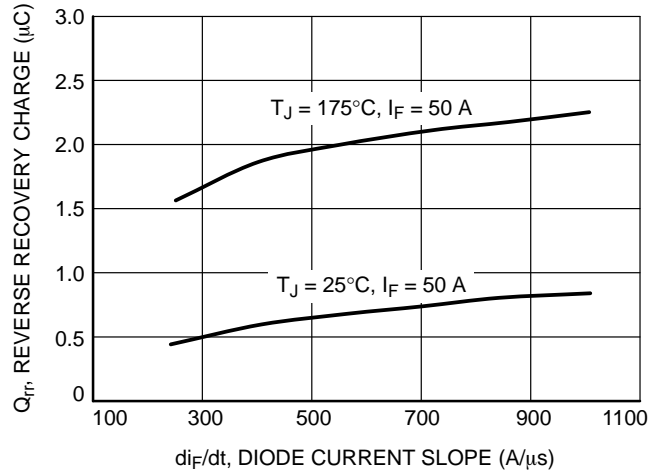

Figure 20. Q_{rr} vs. di_F/dt
($V_R = 400$ V)

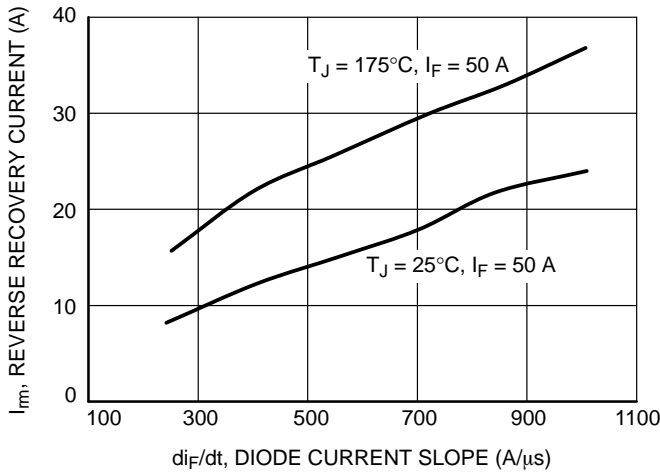

Figure 21. I_{rm} vs. di_F/dt
($V_R = 400$ V)

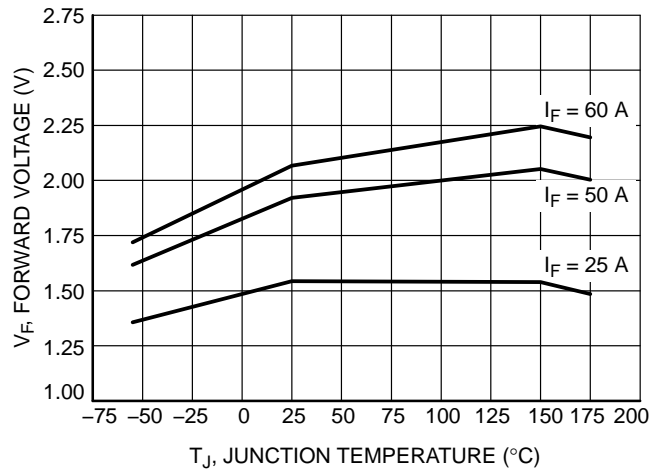

Figure 22. V_F vs. T_J

NGTB50N60FL2WG

TYPICAL CHARACTERISTICS

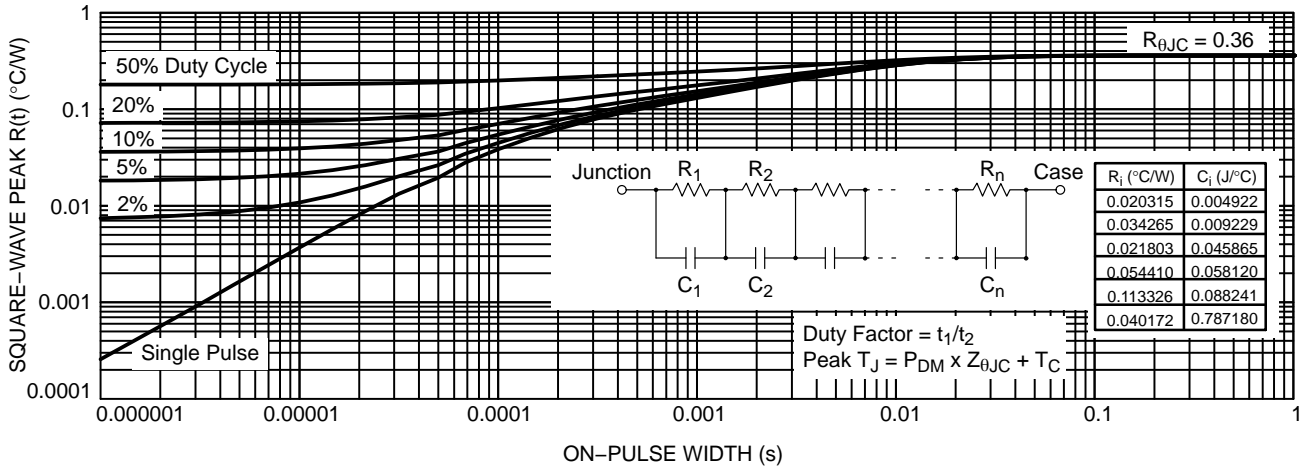

Figure 23. IGBT Transient Thermal Impedance

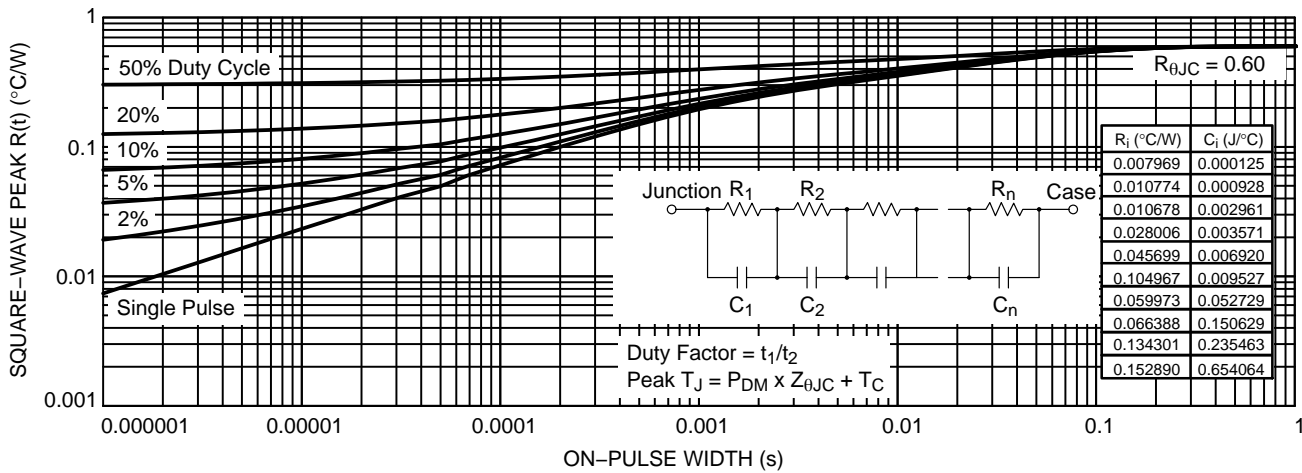

Figure 24. Diode Transient Thermal Impedance

NGTB50N60FL2WG

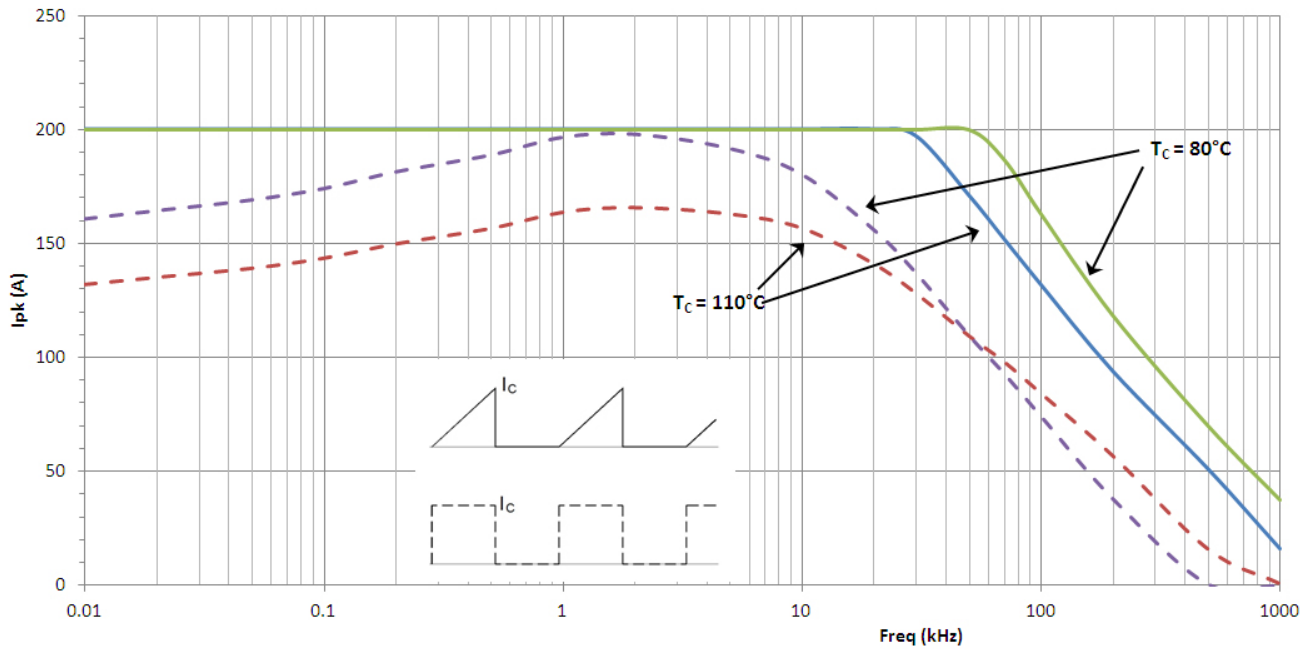

Figure 25. Collector Current vs. Switching Frequency

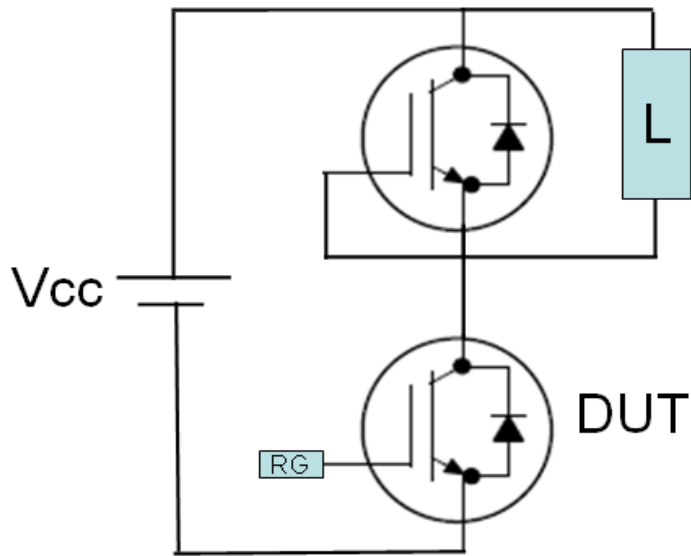

Figure 26. Test Circuit for Switching Characteristics

NGTB50N60FL2WG

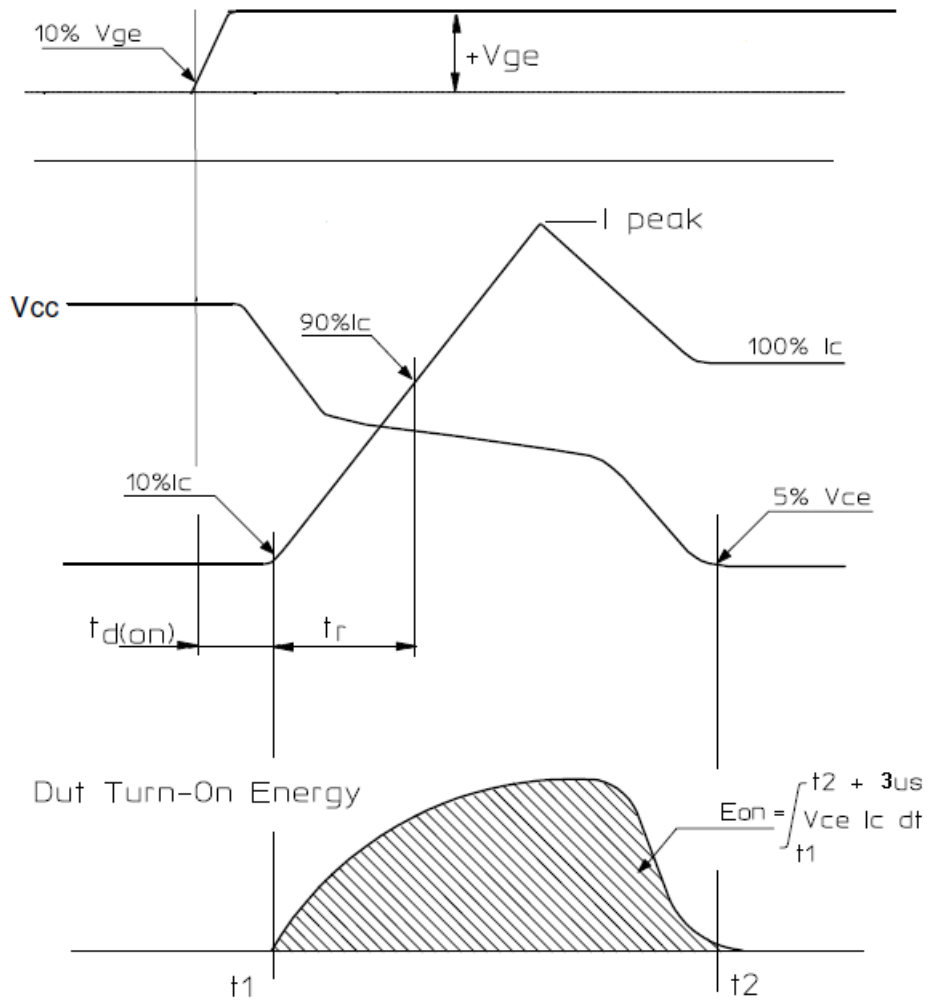

Figure 27. Definition of Turn On Waveform

NGTB50N60FL2WG



Figure 28. Definition of Turn Off Waveform

MECHANICAL CASE OUTLINE PACKAGE DIMENSIONS

ON Semiconductor®



TO-247
CASE 340AL
ISSUE D

DATE 17 MAR 2017

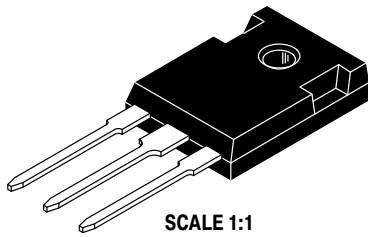

SCALE 1:1

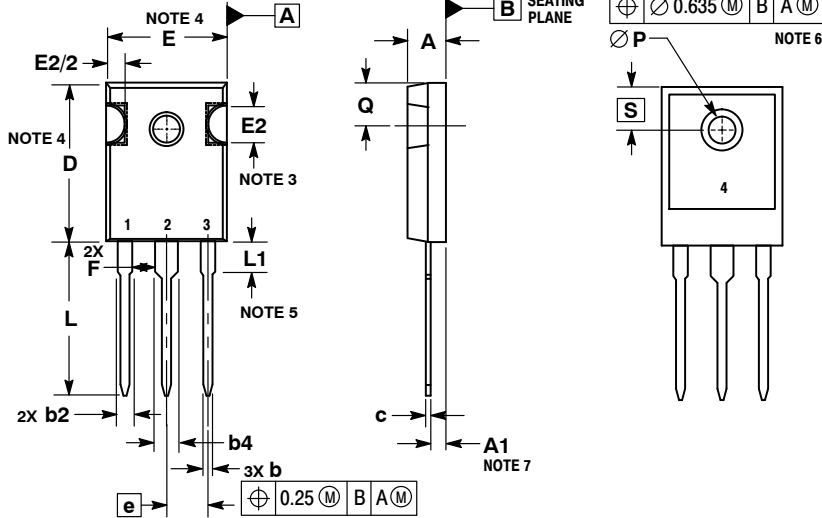

NOTES:

1. DIMENSIONING AND TOLERANCING PER ASME Y14.5M, 1994.
2. CONTROLLING DIMENSION: MILLIMETERS.
3. SLOT REQUIRED, NOTCH MAY BE ROUNDED.
4. DIMENSIONS D AND E DO NOT INCLUDE MOLD FLASH. MOLD FLASH SHALL NOT EXCEED 0.13 PER SIDE. THESE DIMENSIONS ARE MEASURED AT THE OUTERMOST EXTREME OF THE PLASTIC BODY.
5. LEAD FINISH IS UNCONTROLLED IN THE REGION DEFINED BY L1.
6. ØP SHALL HAVE A MAXIMUM DRAFT ANGLE OF 1.5° TO THE TOP OF THE PART WITH A MAXIMUM DIAMETER OF 3.91.
7. DIMENSION A1 TO BE MEASURED IN THE REGION DEFINED BY L1.

| MILLIMETERS | | |
|-------------|----------|-------|
| DIM | MIN | MAX |
| A | 4.70 | 5.30 |
| A1 | 2.20 | 2.60 |
| b | 1.07 | 1.33 |
| b2 | 1.65 | 2.35 |
| b4 | 2.60 | 3.40 |
| c | 0.45 | 0.68 |
| D | 20.80 | 21.34 |
| E | 15.50 | 16.25 |
| E2 | 4.32 | 5.49 |
| e | 5.45 BSC | |
| F | 2.655 | --- |
| L | 19.80 | 20.80 |
| L1 | 3.81 | 4.32 |
| P | 3.55 | 3.65 |
| Q | 5.40 | 6.20 |
| S | 6.15 BSC | |

GENERIC MARKING DIAGRAM*

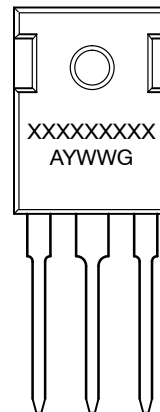

- XXXXXX = Specific Device Code
- A = Assembly Location
- Y = Year
- WW = Work Week
- G = Pb-Free Package

*This information is generic. Please refer to device data sheet for actual part marking.
Pb-Free indicator, "G" or microdot "▪", may or may not be present.

| | | |
|------------------|-------------|--|
| DOCUMENT NUMBER: | 98AON16119F | Electronic versions are uncontrolled except when accessed directly from the Document Repository. Printed versions are uncontrolled except when stamped "CONTROLLED COPY" in red. |
| DESCRIPTION: | TO-247 | PAGE 1 OF 1 |

ON Semiconductor and are trademarks of Semiconductor Components Industries, LLC dba ON Semiconductor or its subsidiaries in the United States and/or other countries. ON Semiconductor reserves the right to make changes without further notice to any products herein. ON Semiconductor makes no warranty, representation or guarantee regarding the suitability of its products for any particular purpose, nor does ON Semiconductor assume any liability arising out of the application or use of any product or circuit, and specifically disclaims any and all liability, including without limitation special, consequential or incidental damages. ON Semiconductor does not convey any license under its patent rights nor the rights of others.

onsemi, **Onsemi**, and other names, marks, and brands are registered and/or common law trademarks of Semiconductor Components Industries, LLC dba "**onsemi**" or its affiliates and/or subsidiaries in the United States and/or other countries. **onsemi** owns the rights to a number of patents, trademarks, copyrights, trade secrets, and other intellectual property. A listing of **onsemi**'s product/patent coverage may be accessed at www.onsemi.com/site/pdf/Patent-Marking.pdf. **onsemi** reserves the right to make changes at any time to any products or information herein, without notice. The information herein is provided "as-is" and **onsemi** makes no warranty, representation or guarantee regarding the accuracy of the information, product features, availability, functionality, or suitability of its products for any particular purpose, nor does **onsemi** assume any liability arising out of the application or use of any product or circuit, and specifically disclaims any and all liability, including without limitation special, consequential or incidental damages. Buyer is responsible for its products and applications using **onsemi** products, including compliance with all laws, regulations and safety requirements or standards, regardless of any support or applications information provided by **onsemi**. "Typical" parameters which may be provided in **onsemi** data sheets and/or specifications can and do vary in different applications and actual performance may vary over time. All operating parameters, including "Typicals" must be validated for each customer application by customer's technical experts. **onsemi** does not convey any license under any of its intellectual property rights nor the rights of others. **onsemi** products are not designed, intended, or authorized for use as a critical component in life support systems or any FDA Class 3 medical devices or medical devices with a same or similar classification in a foreign jurisdiction or any devices intended for implantation in the human body. Should Buyer purchase or use **onsemi** products for any such unintended or unauthorized application, Buyer shall indemnify and hold **onsemi** and its officers, employees, subsidiaries, affiliates, and distributors harmless against all claims, costs, damages, and expenses, and reasonable attorney fees arising out of, directly or indirectly, any claim of personal injury or death associated with such unintended or unauthorized use, even if such claim alleges that **onsemi** was negligent regarding the design or manufacture of the part. **onsemi** is an Equal Opportunity/Affirmative Action Employer. This literature is subject to all applicable copyright laws and is not for resale in any manner.

PUBLICATION ORDERING INFORMATION

LITERATURE FULFILLMENT:

Email Requests to: orderlit@onsemi.com

onsemi Website: www.onsemi.com

TECHNICAL SUPPORT

North American Technical Support:

Voice Mail: 1 800-282-9855 Toll Free USA/Canada

Phone: 011 421 33 790 2910

Europe, Middle East and Africa Technical Support:

Phone: 00421 33 790 2910

For additional information, please contact your local Sales Representative