

CRF24060

60 W, SiC RF Power MESFET

Cree's CRF24060 is an unmatched silicon carbide (SiC) RF power Metal-Semiconductor Field-Effect Transistor (MESFET). SiC has superior properties compared to silicon or gallium arsenide, including higher breakdown voltage, higher saturated electron drift velocity, and higher thermal conductivity. SiC MESFETs offer greater efficiency, greater power density, and wider bandwidths compared to Si and GaAs transistors.



Package Type: 440193
PN: CRF24060F

FEATURES

- 13 dB Small Signal Gain
- High Efficiency
- 50 W minimum P_{1dB}
- Up to 2400 MHz Operation
- 48 V Operation
- High Breakdown Voltage
- High Temperature Operation

APPLICATIONS

- Wideband Military Communications
- Secure Comms for Homeland Defense
- Class A, A/B Amplifiers
- TDMA, EDGE, CDMA, W-CDMA
- Broadband Amplifiers
- MMDS

Typical Performance

- Drain Efficiency of 45% at 1500 MHz at 60 W P_{OUT}
- IMD -31 dBc at 1000 MHz at 50 W PEP
- 13 dB Small Signal Gain at 1500 MHz
- 60 W @ P_{1dB} at 1500 MHz
- 80 W P_{3dB} at 1500 MHz

Note: Measured in amplifier circuit CRF24060-TB at $V_{DS} = 48$ V, $I_{DQ} = 2000$ mA.





Absolute Maximum Ratings (not simultaneous) at 25 °C Case Temperature

Parameter	Symbol	Rating	Units
Drain-source Voltage	V_{DSS}	120	Volts
Gate to source Voltage	V_{GS}	-20, +3	Volts
Storage Temperature	T_{STG}	-55, +150	°C
Operating Junction Temperature	T_J	255	°C
Thermal Resistance, Junction to Case	$R_{\theta JC}$	1.4	°C/W
Screw Torque	T	80	in-oz
Soldering Temperature	T_S	225	°C

Electrical Characteristics ($T_C = 25^\circ\text{C}$)

Characteristics	Symbol	Min.	Typ.	Max.	Units	Conditions
DC Characteristics³						
Gate Threshold Voltage	$V_{GS(th)}$	-13	-10	-	VDC	$V_{DS} = 10\text{ V}, I_D = 2.5\text{ mA}$
Gate Quiescent Voltage	$V_{GS(Q)}$	-	-7	-	VDC	$V_{DS} = 48\text{ V}, I_D = 2000\text{ mA}$
Zero Gate Voltage Drain Current	I_{DSS}	6.0	7.5	9.0	A	$V_{DS} = 10\text{ V}, V_{GS} = 0\text{ V}$
Drain-Source Breakdown Voltage	$V_{(BR)DSS}$	100	-	-	VDC	$V_{GS} = -18\text{ V}, I_D = 50\text{ mA}$
Forward Transconductance	g_m	700	800	-	mS	$V_{DS} = 48\text{ V}, I_D = 2000\text{ mA}$
Case Operating Temperature	T_C	-30	-	125	°C	
RF Characteristics						
Gain	G_{SS}	10	13	-	dB	$V_{DD} = 48\text{ V}, I_{DQ} = 2000\text{ mA}, f = 1100\text{ MHz}$
Power Output at 1 dB Compression	P_{1dB}	50	60	-	W	$V_{DD} = 48\text{ V}, I_{DQ} = 2000\text{ mA}, f = 1100\text{ MHz}$
Power Output at 3 dB Compression	P_{3dB}	-	80	-	W	$V_{DD} = 48\text{ V}, I_{DQ} = 2000\text{ mA}, f = 1100\text{ MHz}$
Drain Efficiency ^{1,2}	η	40	45	-	%	$V_{DD} = 48\text{ V}, I_{DQ} = 2000\text{ mA}, f = 1100\text{ MHz}, P_{OUT} = P_{1dB}$
Intermodulation Distortion	IMD_3	-	-31	-	dBc	$V_{DD} = 48\text{ V}, I_{DQ} = 2000\text{ mA}, f_1 = 1000\text{ MHz}, f_2 = 1000.1\text{ MHz}, P_{OUT} = 50\text{ W PEP}$
Output Mismatch Stress	VSWR	10 : 1	-	-	Ψ	No damage at all phase angles, $V_{DD} = 48\text{ V}, I_{DQ} = 2000\text{ mA}, f = 1000\text{ MHz}, P_{OUT} = 50\text{ W CW}$
Dynamic Characteristics						
Input Capacitance	C_{DS}	-	5.0	-	pF	$V_{DS} = 48\text{ V}, V_{GS} = -16\text{ V}, f = 1\text{ MHz}$
Output Capacitance	C_{GS}	-	15	-	pF	$V_{DS} = 48\text{ V}, V_{GS} = -16\text{ V}, f = 1\text{ MHz}$
Reverse Transfer Capacitance	C_{GD}	-	2.8	-	pF	$V_{DS} = 48\text{ V}, V_{GS} = -16\text{ V}, f = 1\text{ MHz}$

Notes:

¹ Drain Efficiency = P_{OUT} / P_{DC}

² Power Added Efficiency (PAE) = $(P_{OUT} - P_{IN}) / P_{DC}$

³ Measured on wafer prior to packaging.



Typical Performance ($T_c = 25^\circ C$, $V_{DS} = 48 V$, $I_{DQ} = 2000 mA$ in Flange Package)

Typical Power Performance Swept CW Data vs Power at 1000 MHz

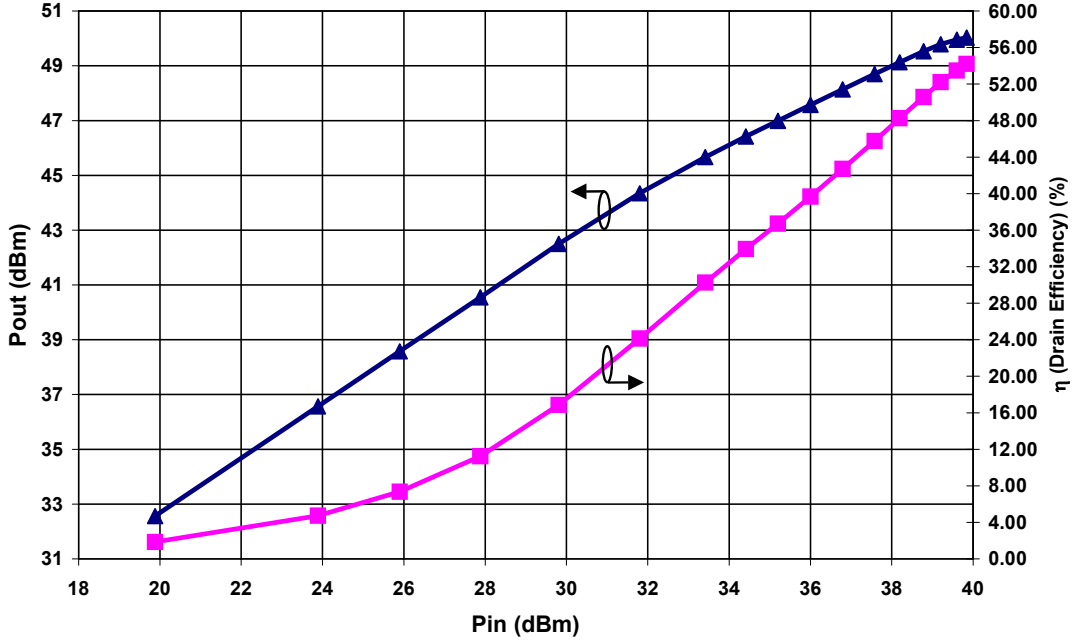

Typical Wideband Performance Swept CW Data vs Frequency

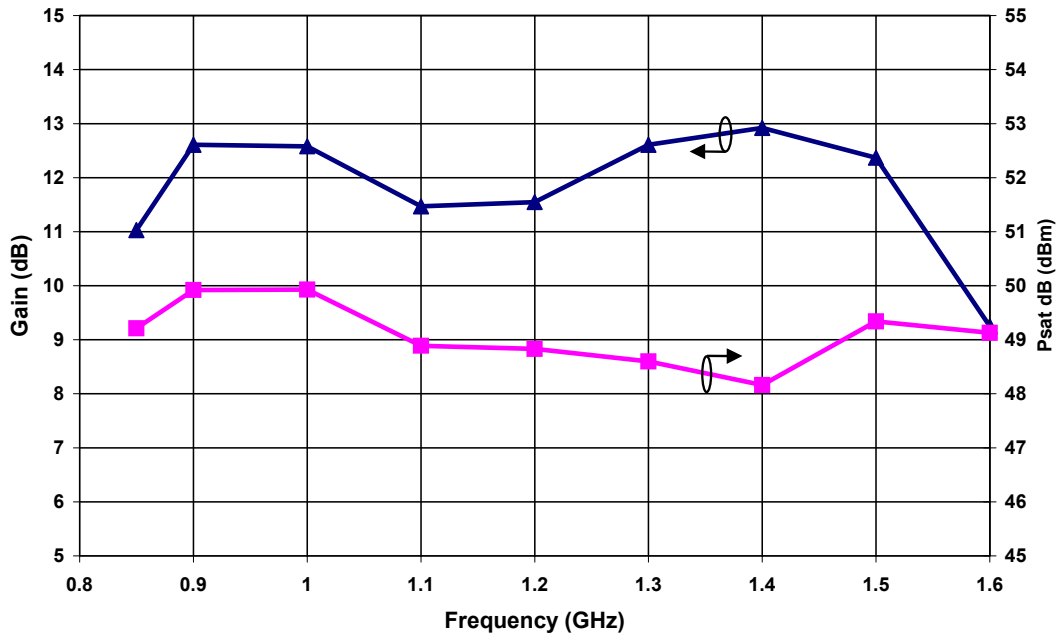



Typical Performance ($V_{DS} = 48\text{ V}$, $I_{DQ} = 2000\text{ mA}$ in the Flange Package)

Typical CW Gain and P1dB vs Frequency

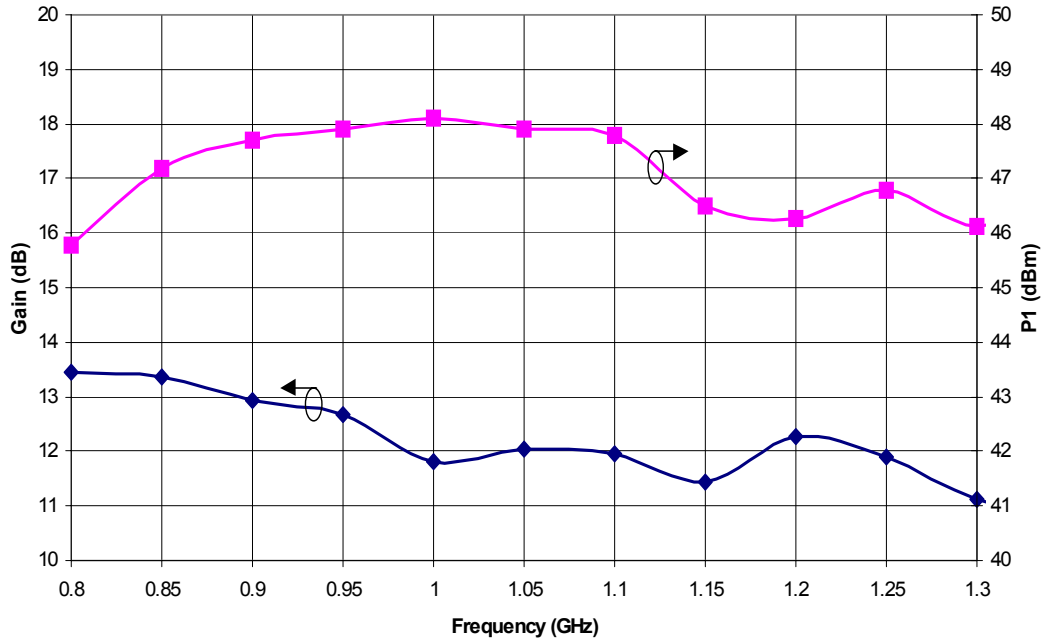

CW Power Sweep at 1.0 GHz

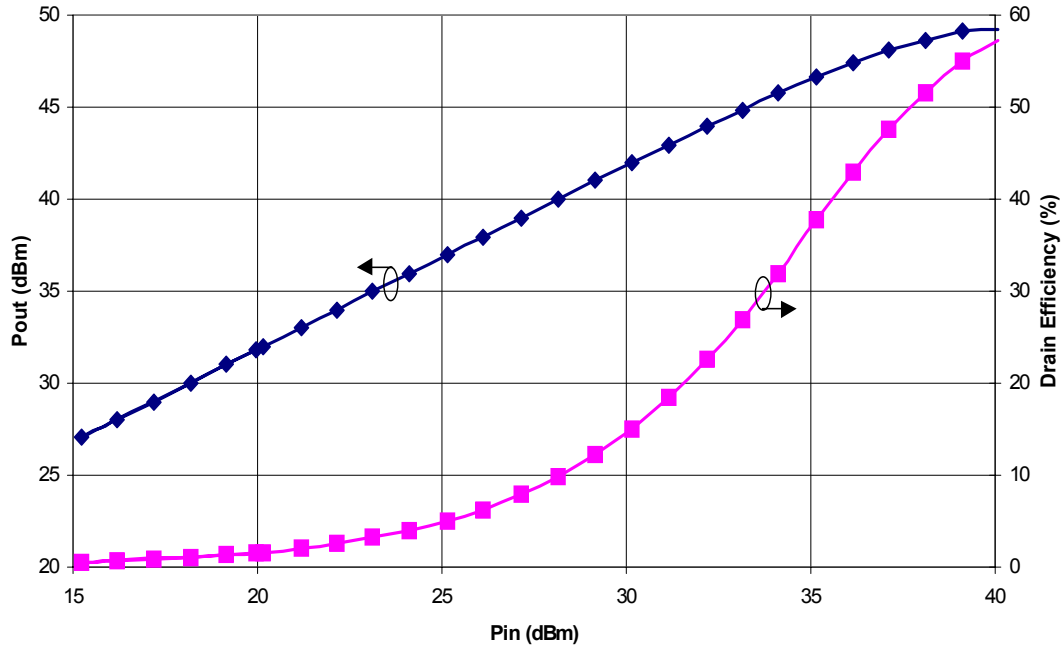



Typical Package S-Parameters (Small Signal, $V_{DS} = 48\text{ V}$, $I_{DQ} = 2000\text{ mA}$, magnitude / angle)

Frequency	S(1,1)	S(2,1)	S(1,2)	S(2,2)
100.0MHz	0.938 / -118.952	11.369 / 117.037	0.027 / 27.543	0.733 / -167.222
200.0MHz	0.924 / -147.861	6.296 / 100.583	0.030 / 11.594	0.786 / -173.220
300.0MHz	0.921 / -159.138	4.291 / 92.762	0.031 / 4.279	0.798 / -175.909
400.0MHz	0.919 / -165.208	3.247 / 87.448	0.031 / -0.529	0.803 / -177.489
500.0MHz	0.919 / -169.113	2.610 / 83.182	0.031 / -4.290	0.806 / -178.595
600.0MHz	0.919 / -171.919	2.183 / 79.451	0.031 / -7.515	0.807 / -179.462
700.0MHz	0.919 / -174.094	1.878 / 76.032	0.031 / -10.429	0.809 / 179.805
800.0MHz	0.919 / -175.877	1.648 / 72.813	0.031 / -13.144	0.810 / 179.152
900.0MHz	0.919 / -177.401	1.470 / 69.730	0.031 / -15.722	0.811 / 178.547
1.000GHz	0.919 / -178.747	1.328 / 66.746	0.031 / -18.201	0.812 / 177.972
1.100GHz	0.919 / -179.968	1.212 / 63.837	0.032 / -20.607	0.813 / 177.413
1.200GHz	0.919 / 178.901	1.116 / 60.986	0.032 / -22.954	0.814 / 176.861
1.300GHz	0.919 / 177.835	1.036 / 58.182	0.032 / -25.254	0.815 / 176.310
1.400GHz	0.919 / 176.816	0.967 / 55.418	0.032 / -27.516	0.816 / 175.755
1.500GHz	0.920 / 175.830	0.908 / 52.686	0.032 / -29.746	0.817 / 175.192
1.600GHz	0.920 / 174.867	0.858 / 49.982	0.032 / -31.948	0.818 / 174.618
1.700GHz	0.920 / 173.917	0.813 / 47.301	0.033 / -34.128	0.819 / 174.029
1.800GHz	0.920 / 172.974	0.775 / 44.640	0.033 / -36.288	0.820 / 173.425
1.900GHz	0.920 / 172.032	0.741 / 41.996	0.033 / -38.432	0.821 / 172.802
2.000GHz	0.920 / 171.086	0.711 / 39.365	0.033 / -40.563	0.821 / 172.158
2.100GHz	0.920 / 170.130	0.685 / 36.744	0.034 / -42.685	0.821 / 171.492
2.200GHz	0.920 / 169.160	0.661 / 34.131	0.034 / -44.800	0.822 / 170.802
2.300GHz	0.919 / 168.172	0.641 / 31.522	0.035 / -46.911	0.822 / 170.086
2.400GHz	0.919 / 167.163	0.623 / 28.915	0.035 / -49.022	0.823 / 169.342
2.500GHz	0.919 / 166.127	0.607 / 26.305	0.035 / -51.135	0.823 / 168.568
2.600GHz	0.918 / 165.062	0.594 / 23.689	0.036 / -53.255	0.823 / 167.762
2.700GHz	0.918 / 163.962	0.582 / 21.064	0.037 / -55.386	0.823 / 166.921
2.800GHz	0.917 / 162.824	0.572 / 18.426	0.037 / -57.530	0.822 / 166.043
2.900GHz	0.916 / 161.642	0.564 / 15.770	0.038 / -59.694	0.821 / 165.125
3.000GHz	0.915 / 160.412	0.557 / 13.091	0.039 / -61.880	0.820 / 164.164

Download this s-parameter file in ".s2p" format at http://www.cree.com/products/wireless_s-parameters.asp



Typical Package S-Parameters
(Small Signal, $V_{DS} = 48\text{ V}$, $I_{DQ} = 1000\text{ mA}$, magnitude / angle)

Frequency	S(1,1)	S(2,1)	S(1,2)	S(2,2)
100.0MHz	0.927 / -116.548	11.083 / 117.528	0.033 / 28.066	0.682 / -162.593
200.0MHz	0.909 / -146.266	6.173 / 100.326	0.037 / 11.402	0.745 / -170.406
300.0MHz	0.904 / -157.893	4.209 / 91.937	0.038 / 3.552	0.760 / -173.673
400.0MHz	0.903 / -164.137	3.182 / 86.138	0.038 / -1.708	0.767 / -175.463
500.0MHz	0.903 / -168.127	2.554 / 81.430	0.038 / -5.879	0.771 / -176.632
600.0MHz	0.903 / -170.973	2.132 / 77.286	0.039 / -9.485	0.774 / -177.490
700.0MHz	0.903 / -173.162	1.829 / 73.477	0.039 / -12.756	0.777 / -178.179
800.0MHz	0.904 / -174.945	1.602 / 69.888	0.039 / -15.808	0.780 / -178.772
900.0MHz	0.905 / -176.460	1.424 / 66.455	0.039 / -18.705	0.783 / -179.309
1.000GHz	0.906 / -177.792	1.282 / 63.140	0.039 / -21.483	0.785 / -179.817
1.100GHz	0.906 / -178.998	1.167 / 59.919	0.039 / -24.169	0.788 / 179.689
1.200GHz	0.907 / 179.888	1.070 / 56.776	0.039 / -26.777	0.791 / 179.195
1.300GHz	0.908 / 178.839	0.989 / 53.699	0.039 / -29.319	0.794 / 178.696
1.400GHz	0.909 / 177.835	0.920 / 50.680	0.039 / -31.803	0.797 / 178.185
1.500GHz	0.910 / 176.863	0.861 / 47.714	0.039 / -34.236	0.800 / 177.657
1.600GHz	0.911 / 175.912	0.809 / 44.794	0.039 / -36.623	0.803 / 177.111
1.700GHz	0.912 / 174.974	0.764 / 41.917	0.039 / -38.968	0.806 / 176.543
1.800GHz	0.912 / 174.040	0.725 / 39.077	0.039 / -41.277	0.809 / 175.952
1.900GHz	0.913 / 173.105	0.690 / 36.272	0.039 / -43.551	0.811 / 175.335
2.000GHz	0.914 / 172.165	0.659 / 33.498	0.039 / -45.796	0.814 / 174.693
2.100GHz	0.914 / 171.213	0.632 / 30.751	0.040 / -48.014	0.816 / 174.023
2.200GHz	0.915 / 170.247	0.608 / 28.027	0.040 / -50.210	0.819 / 173.325
2.300GHz	0.915 / 169.262	0.587 / 25.323	0.040 / -52.387	0.821 / 172.596
2.400GHz	0.916 / 168.255	0.568 / 22.635	0.040 / -54.549	0.823 / 171.837
2.500GHz	0.916 / 167.221	0.552 / 19.959	0.041 / -56.701	0.824 / 171.046
2.600GHz	0.916 / 166.157	0.537 / 17.290	0.041 / -58.846	0.826 / 170.220
2.700GHz	0.916 / 165.058	0.525 / 14.625	0.042 / -60.988	0.827 / 169.358
2.800GHz	0.916 / 163.922	0.514 / 11.959	0.042 / -63.134	0.828 / 168.459
2.900GHz	0.916 / 162.742	0.505 / 9.286	0.043 / -65.287	0.829 / 167.519
3.000GHz	0.915 / 161.514	0.497 / 6.601	0.044 / -67.452	0.829 / 166.536

Download this s-parameter file in ".s2p" format at http://www.cree.com/products/wireless_s-parameters.asp

CRF24060-TB Demonstration Test Fixture

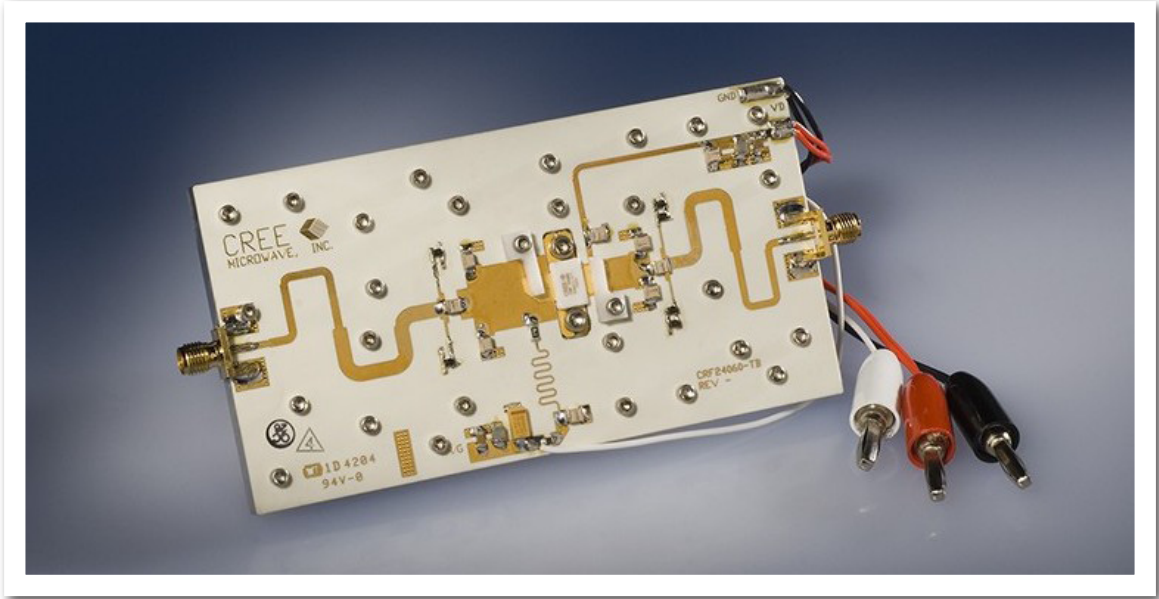

CRF24060-TB Demonstration Test Fixture Diagram

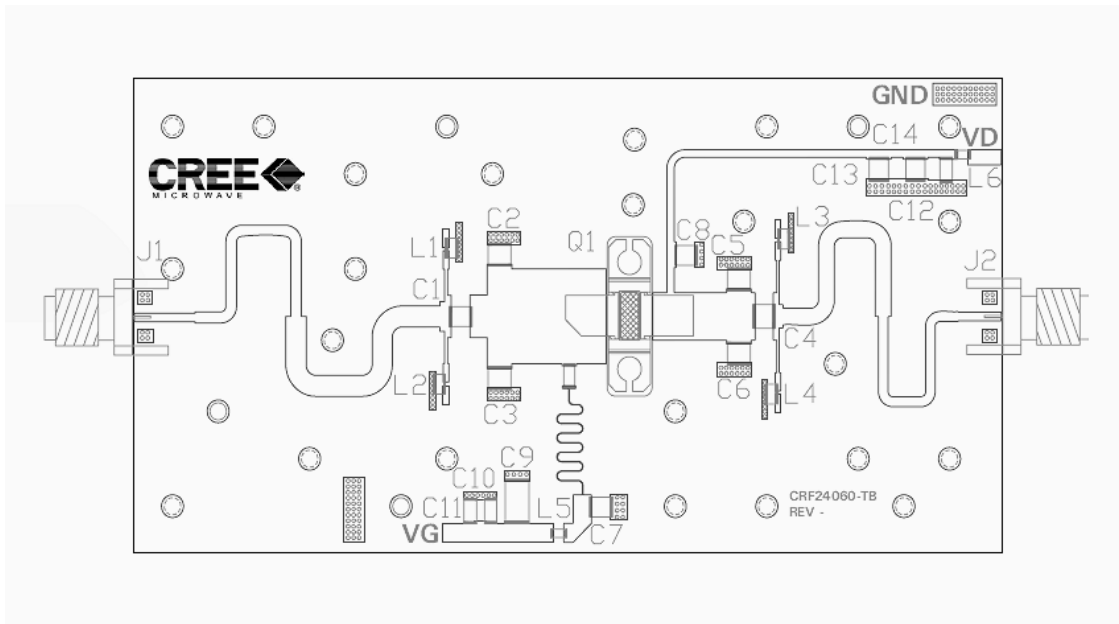

CRF24060-TB Demonstration Test Fixture Schematic

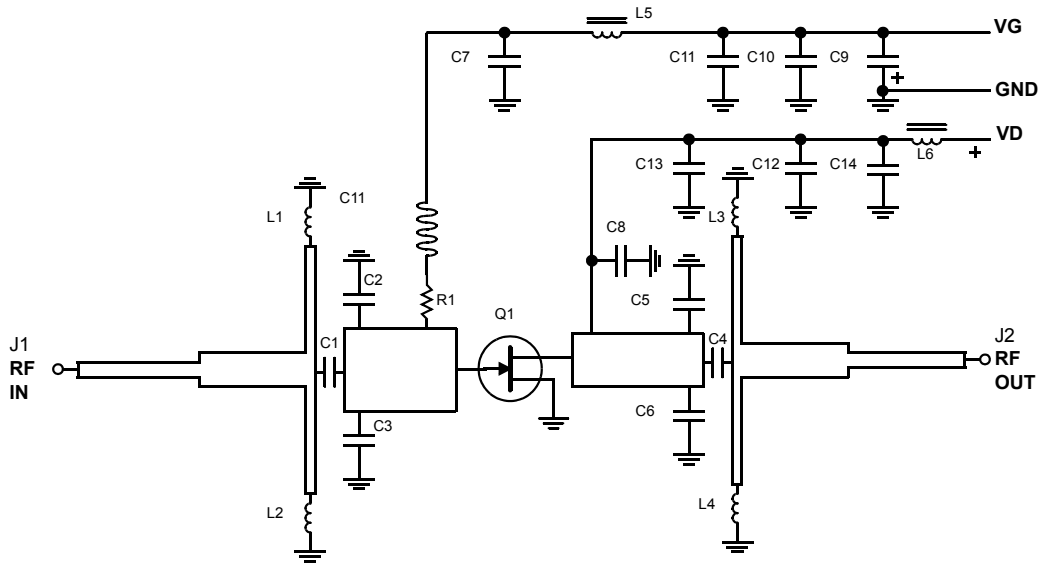

CRF24060-TB Demonstration Test Fixture Bill of Materials

Designator	Description	Qty
C1	CAP, 10pF, DILABS C17AH, 100F, 7UXL	1
C2,C3	CAP, 3.9pF, DILABS C17AH, 3R9B, 7UXL	2
C4	CAP, 8.2pF, DILABS C17AH, 8R2A, 7UXL	1
C5,C6	CAP, 2.7pF, DILABS C17AH, 2R7A, 4UXL	2
C7,C8,C13	CAP, 30pF, DILABS C17AH, 300M, 7UXL	3
C9	CAP, 10uF, 25V, TANTALUM	1
C10,C12	CAP, 180pF, DILABS C17AH, 181J, 3UX	2
C11,C14	CAP, 0.1uF, 100V, 1206, CERAMIC	2
R1	RES, 27 OHM, 0.1W, 1206	1
L1,L2, L3,L4	MICROSPRING, 3T, COILCRAFT, 0906-3J	4
L5,L6	FERRITE, MURATA BLM21P220SG	2
J1,J2	CONNECTOR, SMA, FLANGE MOUNT, FEMALE	2
Q1	CRF24060	1

Note: Some values may differ due to substitution in the event of temporarily unavailable parts.

Product Dimensions - CRF24060F (Package Type — 440193)

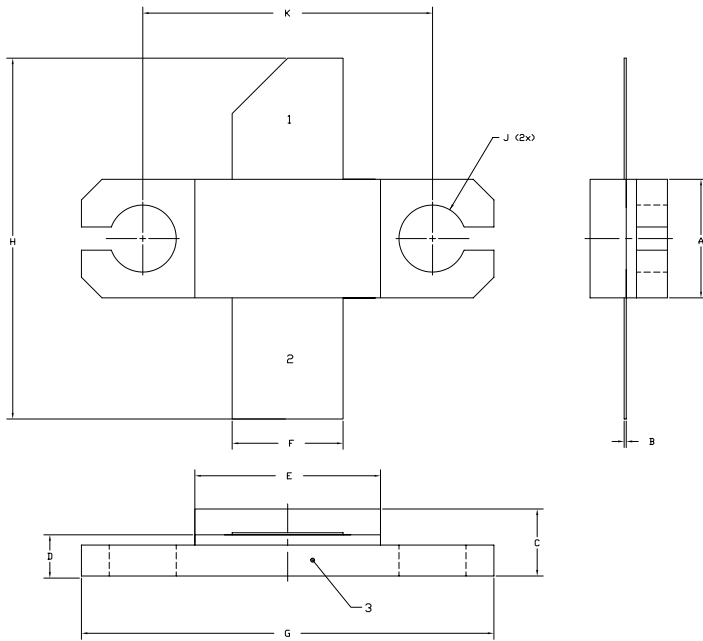

NOTES:

1. DIMENSIONING AND TOLERANCING PER ANSI Y14.5M, 1982.
2. CONTROLLING DIMENSION: INCH.
3. ADHESIVE FROM LID MAY EXTEND A MAXIMUM OF 0.020" BEYOND EDGE OF LID.
4. LID MAY BE MISALIGNED TO THE BODY OF THE PACKAGE BY A MAXIMUM OF 0.008" IN ANY DIRECTION.
5. ALL PLATED SURFACES ARE NI/AU

DIM	INCHES		MILLIMETERS	
	MIN	MAX	MIN	MAX
A	0.225	0.235	5.72	5.97
B	0.004	0.006	0.10	0.15
C	0.125	0.135	3.18	3.43
D	0.077	0.087	1.96	2.21
E	0.355	0.365	9.02	9.27
F	0.210	0.220	5.33	5.59
G	0.795	0.805	20.19	20.45
H	0.670	0.730	17.02	18.54
J	ø .130		3.30	
k	0.562		14.28	

- PIN 1. GATE
 PIN 2. DRAIN
 PIN 3. SOURCE



Disclaimer

Specifications are subject to change without notice. Cree, Inc. believes the information contained within this data sheet to be accurate and reliable. However, no responsibility is assumed by Cree for any infringement of patents or other rights of third parties which may result from its use. No license is granted by implication or otherwise under any patent or patent rights of Cree. Cree makes no warranty, representation or guarantee regarding the suitability of its products for any particular purpose. "Typical" parameters are the average values expected by Cree in large quantities and are provided for information purposes only. These values can and do vary in different applications, and actual performance can vary over time. All operating parameters should be validated by customer's technical experts for each application. Cree products are not designed, intended, or authorized for use as components in applications intended for surgical implant into the body or to support or sustain life, in applications in which the failure of the Cree product could result in personal injury or death, or in applications for planning, construction, maintenance or direct operation of a nuclear facility. Cree and the Cree logo are registered trademarks of Cree, Inc.

For more information, please contact:

Cree, Inc.
4600 Silicon Drive
Durham, NC 27703
www.cree.com/wireless

Ryan Baker
Cree, Marketing
919.287.7816

Tom Dekker
Cree, Sales Director
919.313.5639