

HSR312, HSR312L, HSR412, HSR412L Photovoltaic Solid-State Relay Optocouplers

Features

- 4,000 VRMS Isolation
- Wide operating voltage range
- 250V (HSR312, HSR312L)
- 400V (HSR412, HSR412L)
- Solid-State Reliability
- Bounce-Free Operation
- 4000V ESD Rating (HBM)
- UL and CSA approved

Applications

- On/Off Hook Switch
- Replacement for Mechanical Relays
- Dial Out Relay
- Ring Injection Relay
- General Switching
- Ground Start

Description

The HSR312 and HSR412 devices consist of a AlGaAs infrared emitting diode optically coupled to a power MOSFET detector which is driven by a photovoltaic generator. The devices are housed in a 6-pin dual-in-line package. The HSR312L and HSR412L employ an active current limit circuitry enabling the device to withstand current surge transients.

Schematic

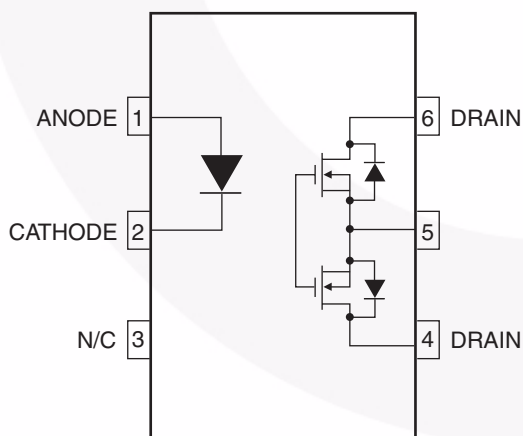

Package Outlines

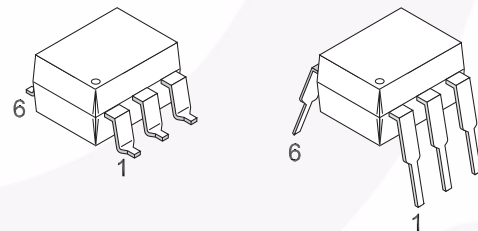

Absolute Maximum Ratings ($T_A = 25^\circ\text{C}$ unless otherwise noted)

Stresses exceeding the absolute maximum ratings may damage the device. The device may not function or be operable above the recommended operating conditions and stressing the parts to these levels is not recommended. In addition, extended exposure to stresses above the recommended operating conditions may affect device reliability. The absolute maximum ratings are stress ratings only.

Symbol	Parameters	Device	Value	Units
TOTAL DEVICE				
T_{STG}	Storage Temperature	All	-40 to +100	$^\circ\text{C}$
T_{OPR}	Operating Temperature	All	-40 to +85	$^\circ\text{C}$
T_{SOL}	Lead Solder Temperature	All	260 for 10 sec	$^\circ\text{C}$
V_{ISO}	Isolation Surge Voltage	All	4000	Vac(RMS)
C_{IO}	Maximum Input/Output Capacitance	All	1.0	pF
R_{IO}	Maximum Input/Output Resistance	All	10^{12}	Ω

Electrical Characteristics (T_A = -40°C to +85°C unless otherwise specified)

Input Characteristics

Symbol	Parameters/ Test Conditions	Connection	Limit	HSR312	HSR312L	HSR412	HSR412L	Units
I _{F(ON)}	Control Current	Series or Parallel	Max.	2.0	2.0	3.0	3.0	mA
I _{F(OFF)}	Control Current for Off-State Resistance (T _A = 25°C)	Series or Parallel	Min.	0.4	0.4	0.4	0.4	mA
I _F	Control Current Range	Series or Parallel	Min.	2.0	2.0	3.0	3.0	mA
			Max.	25	25	25	25	
V _R	Reverse Voltage	Series or Parallel	Min.	7	7	7	7	V
V _F	Forward Voltage (I _F = 10mA)	Series or Parallel	Max.	1.6	1.6	1.6	1.6	V

Output Characteristics

Symbol	Parameters/ Test Conditions	Connection	Limit	HSR312	HSR312L	HSR412	HSR412L	Units
V _{OPR}	Operating Voltage Range	Series or Parallel	Max.	250	250	400	400	V _{DC} or V _{AC(PEAK)}
I _L	Load Current T _A = +40°C, 5mA control (see Fig. 1 & 2)	Series	Max.	190	170	140	120	mA
		Parallel	Max.	320	300	210	200	
R _{ON}	On-State Resistance T _A = 25°C, 50mA pulsed load, 5mA control	Series	Max.	10	15	27	35	Ω
		Parallel	Max.	3	4.25	7	9	
	Off-State Leakage Current T _A = 25°C, ±250V for HSR312/L, ±400V for HSR412/L	Series or Parallel	Max.	1.0	1.0	1.0	1.0	μA
I _{LMT}	Current Limit T _A = +25°C, 5mA control	Series	Min.	N/A	190	N/A	130	mA
			Max.	N/A	300	N/A	220	
		Parallel	Min.	N/A	330	N/A	260	
			Max.	N/A	560	N/A	440	
T _{ON}	Turn-On Time T _A = +25°C for 50mA, 100VDC load, 5mA control	Series or Parallel	Max.	3.0	3.0	2.0	2.0	mS
T _{OFF}	Turn-Off Time T _A = +25°C for 50mA, 100VDC load, 5mA control	Series or Parallel	Max.	0.5	0.5	0.5	0.5	mS
	Thermal Offset Voltage 5mA control	Series or Parallel	Max.	N/A	N/A	0.5	0.5	mV
C _O	Output Capacitance 50V _{DC}	Series	Max.	50	50	12	12	pF

Isolation Characteristics

Symbol	Characteristics	Test Conditions	Limit	HSR312	HSR312L	HSR412	HSR412L	Units
V _{ISO}	Input-Output Isolation Voltage	I _{I-O} ≤ 2 μA	Max	4000	4000	4000	4000	V

Typical Performance Curves

Figure 1. Forward Current vs. Forward Voltage

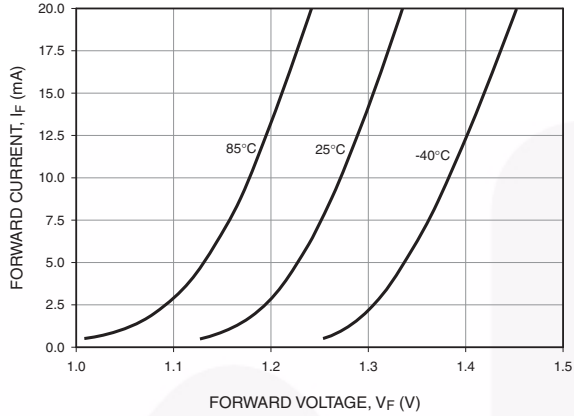

Figure 2. Normalized on Resistance vs. Ambient Temperature

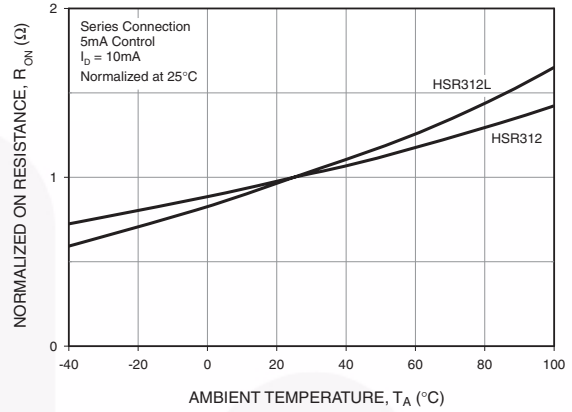

Figure 3. Normalized on Resistance vs. Ambient Temperature

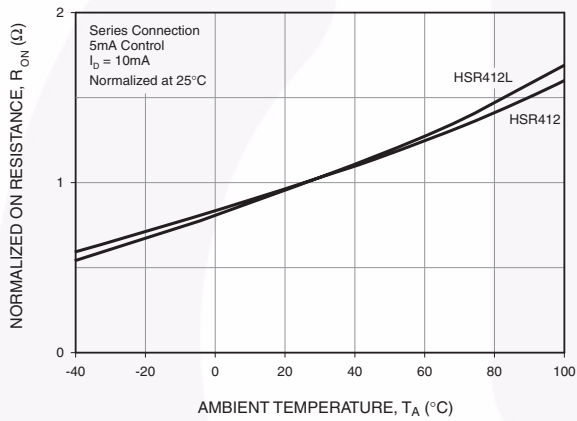

Figure 4. Load Current vs. Voltage Drop

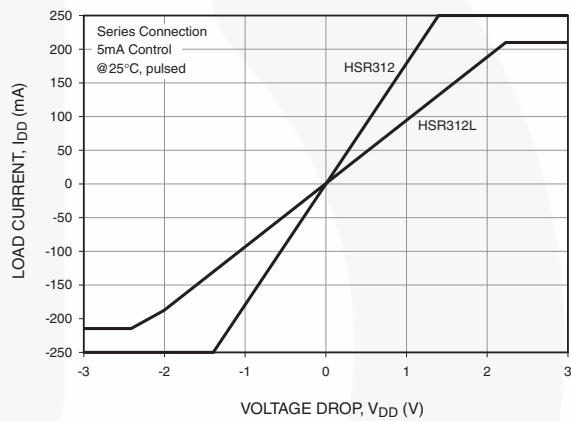

Figure 5. Load Current vs. Voltage Drop

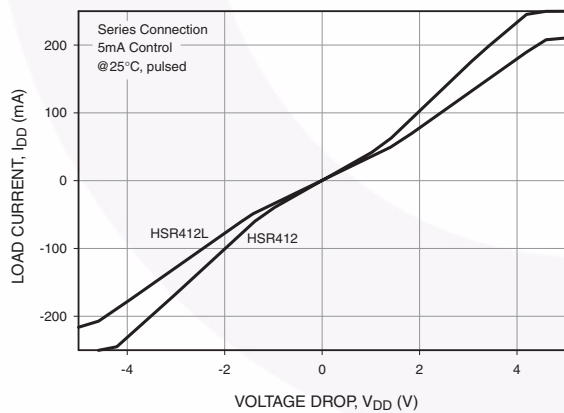
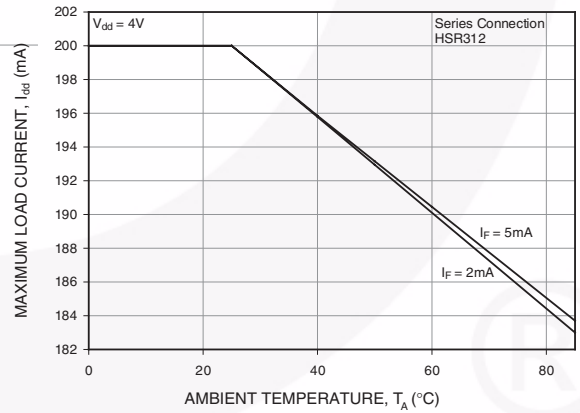

Figure 6. Maximum Load Current Vs Ambient Temperature



Typical Performance Curves (Continued)

Figure 7. Maximum Load Current Vs Ambient Temperature

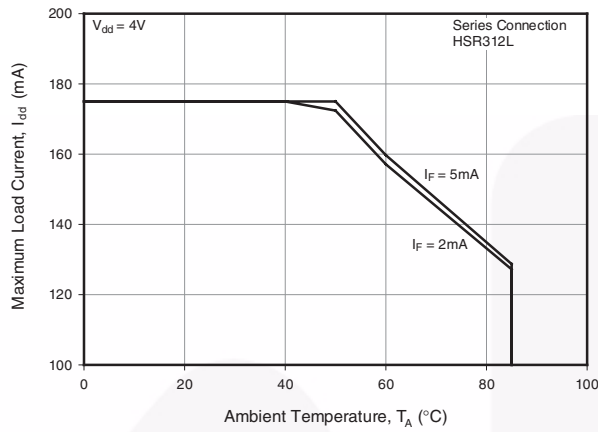

Figure 8. Maximum Load Current Vs Ambient Temperature

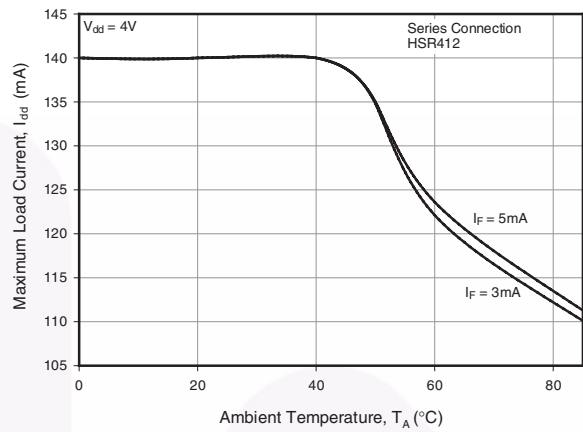

Figure 9. Maximum Load Current Vs Ambient Temperature

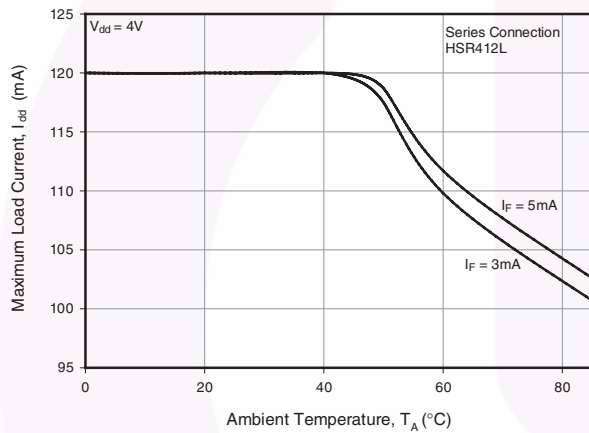

Figure 10. Off State Current vs. Ambient Temperature

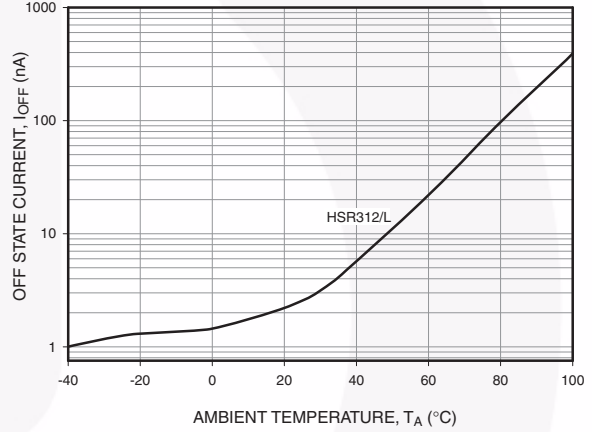

Figure 11. Off State Current vs. Ambient Temperature

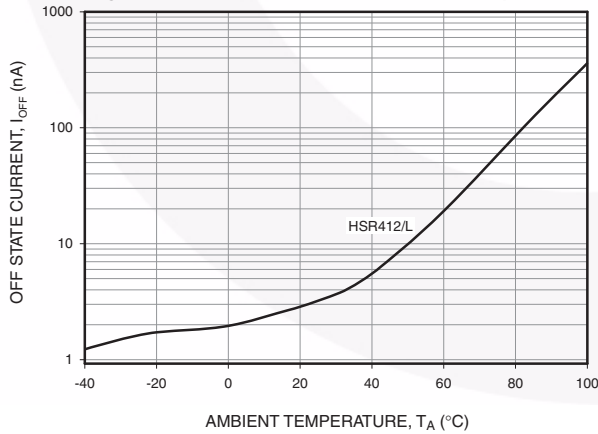
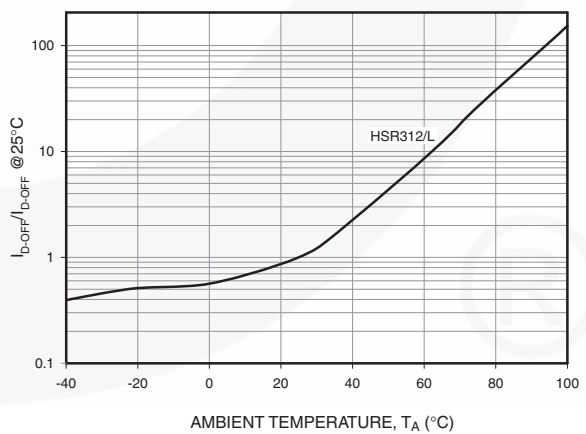
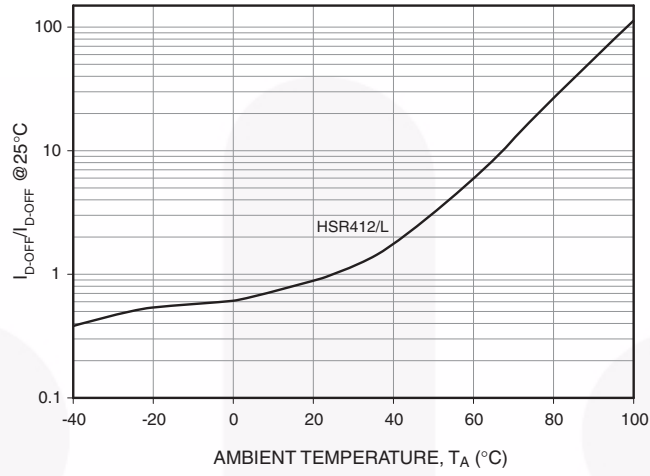

Figure 12. Normalized Off State Leakage vs. Ambient Temperature



Typical Performance Curves (Continued)

Figure 13. Normalized Off State Leakage vs. Ambient Temperature



Series Connection

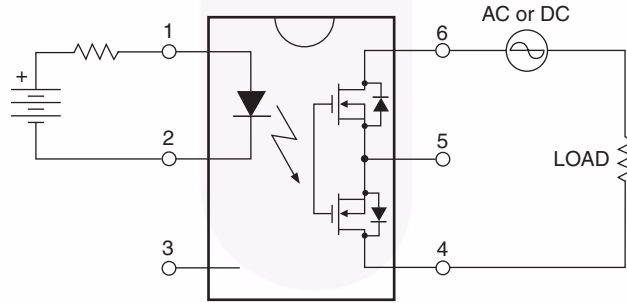

Parallel Connection

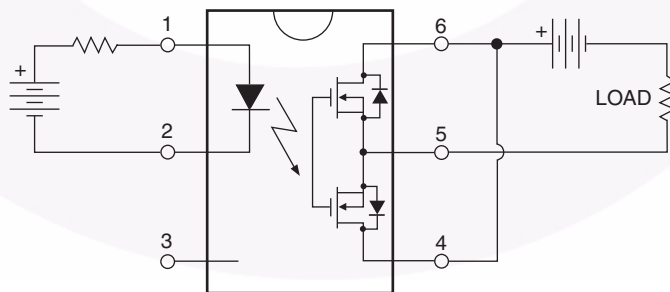

Package Dimensions

Through Hole

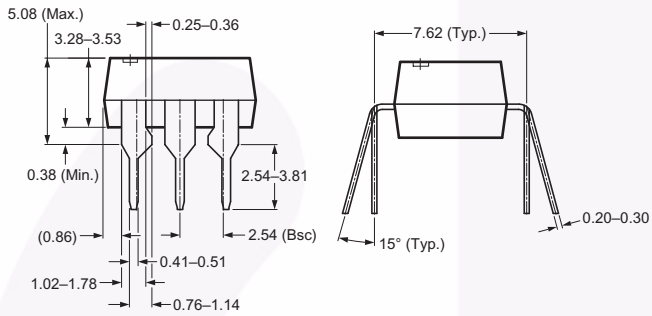
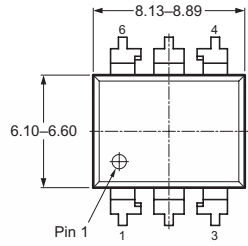

Surface Mount

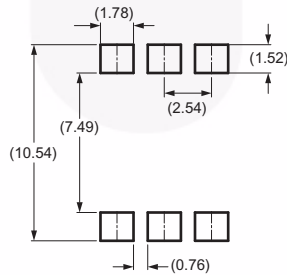
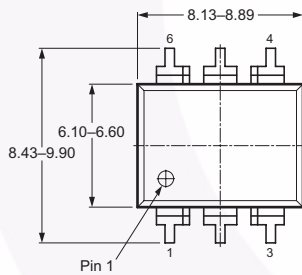

Recommended Pad Layout

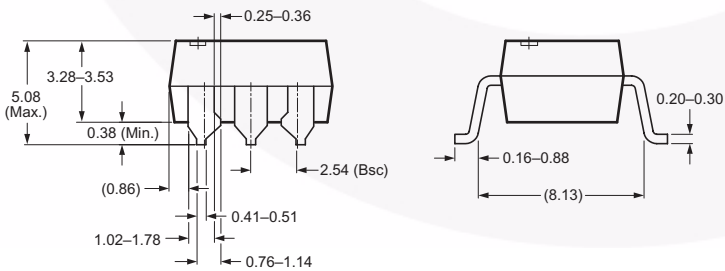

Note:
All dimensions in mm.

Ordering Information

Option	Order Entry Identifier (Example)	Description
No option	HSR312	Standard Through Hole Device
S	HSR312S	Surface Mount Lead Bend
SR2	HSR312SR2	Surface Mount; Tape and Reel

Marking Information

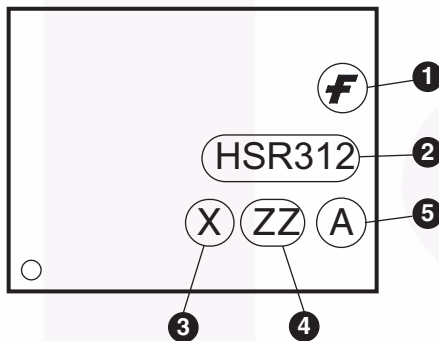

Definitions	
1	Fairchild logo
2	Device number
3	One digit year code, e.g., '3'
4	Two digit work week ranging from '01' to '53'
5	Assembly package code

Carrier Tape Specification

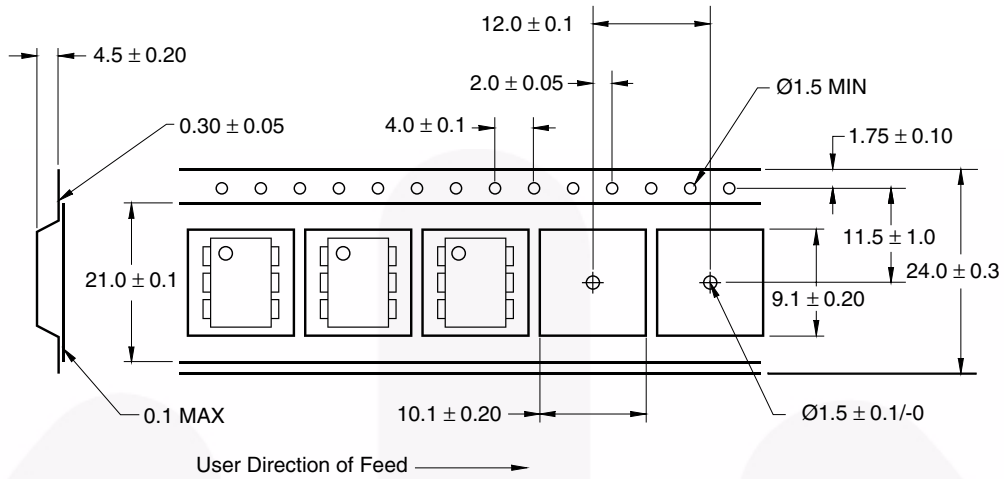



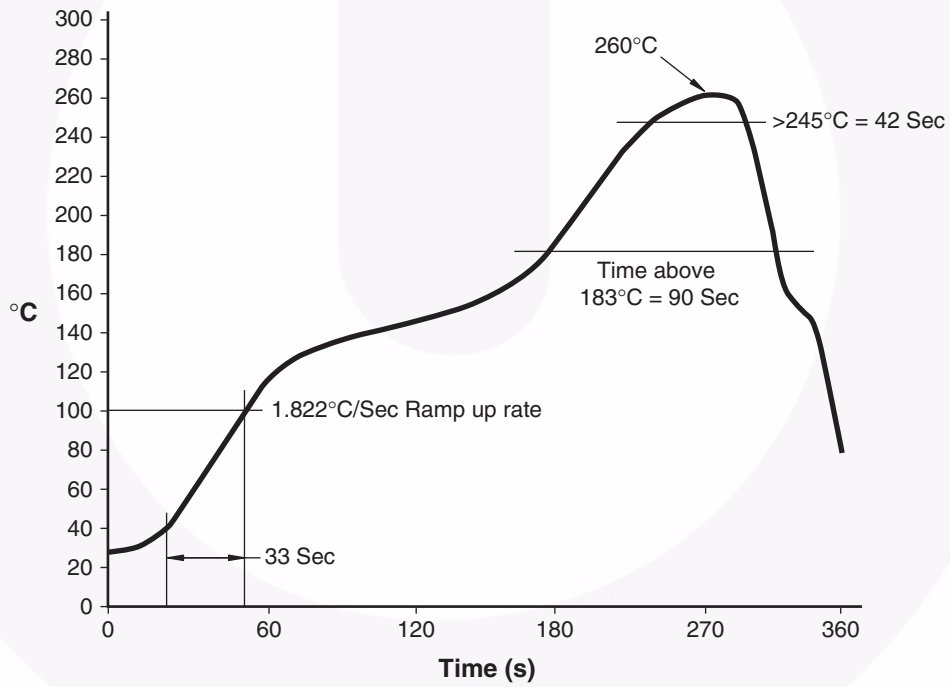

Reflow Profile





TRADEMARKS

The following includes registered and unregistered trademarks and service marks, owned by Fairchild Semiconductor and/or its global subsidiaries, and is not intended to be an exhaustive list of all such trademarks.

- | | | | |
|--|--------------------------|---|--|
| AccuPower™ | FlashWriter®* | Power-SPM™ | 
SYSTEM GENERAL®
The Power Franchise®
the power ™
franchise
TinyBoost™
TinyBuck™
TinyCalc™
TinyLogic®
TINYOPTO™
TinyPower™
TinyPWM™
TinyWire™
TriFault Detect™
TRUECURRENT™*
μSerDes™

SerDes®
UHC®
Ultra FRFET™
UniFET™
VCX™
VisualMax™
XS™ |
| Auto-SPM™ | FPS™ | PowerTrench® | |
| Build it Now™ | F-PFS™ | PowerXS™ | |
| CorePLUS™ | FRFET® | Programmable Active Droop™ | |
| CorePOWER™ | Global Power Resource SM | QFET® | |
| CROSSVOLT™ | Green FPS™ | QS™ | |
| CTL™ | Green FPS™ e-Series™ | Quiet Series™ | |
| Current Transfer Logic™ | Gmax™ | RapidConfigure™ | |
| DEUXPEED® | GTO™ |  ™ | |
| EcoSPARK® | IntelliMAX™ | Saving our world, 1mW/W/kW at a time™ | |
| EfficientMax™ | ISOPLANAR™ | SignalWise™ | |
| EZSWITCH™* | MegaBuck™ | SmartMax™ | |
|  ™* | MICROCOUPLER™ | SMART START™ | |
|  ™ | MicroFET™ | SPM® | |
| Fairchild® | MicroPak™ | STEALTH™ | |
| Fairchild Semiconductor® | MillerDrive™ | SuperFET™ | |
| FACT Quiet Series™ | MotionMax™ | SuperSOT™-3 | |
| FACT® | Motion-SPM™ | SuperSOT™-6 | |
| FAST® | OPTOLOGIC® | SuperSOT™-8 | |
| FastvCore™ | OPTOPLANAR® | SupreMOS™ | |
| FETBench™ | PDP SPM™ | SyncFET™ | |
| | | Sync-Lock™ | |

* Trademarks of System General Corporation, used under license by Fairchild Semiconductor.

DISCLAIMER

FAIRCHILD SEMICONDUCTOR RESERVES THE RIGHT TO MAKE CHANGES WITHOUT FURTHER NOTICE TO ANY PRODUCTS HEREIN TO IMPROVE RELIABILITY, FUNCTION, OR DESIGN. FAIRCHILD DOES NOT ASSUME ANY LIABILITY ARISING OUT OF THE APPLICATION OR USE OF ANY PRODUCT OR CIRCUIT DESCRIBED HEREIN; NEITHER DOES IT CONVEY ANY LICENSE UNDER ITS PATENT RIGHTS, NOR THE RIGHTS OF OTHERS. THESE SPECIFICATIONS DO NOT EXPAND THE TERMS OF FAIRCHILD'S WORLDWIDE TERMS AND CONDITIONS, SPECIFICALLY THE WARRANTY THEREIN, WHICH COVERS THESE PRODUCTS.

LIFE SUPPORT POLICY

FAIRCHILD'S PRODUCTS ARE NOT AUTHORIZED FOR USE AS CRITICAL COMPONENTS IN LIFE SUPPORT DEVICES OR SYSTEMS WITHOUT THE EXPRESS WRITTEN APPROVAL OF FAIRCHILD SEMICONDUCTOR CORPORATION.

As used herein:

- Life support devices or systems are devices or systems which, (a) are intended for surgical implant into the body or (b) support or sustain life, and (c) whose failure to perform when properly used in accordance with instructions for use provided in the labeling, can be reasonably expected to result in a significant injury of the user.
- A critical component in any component of a life support, device, or system whose failure to perform can be reasonably expected to cause the failure of the life support device or system, or to affect its safety or effectiveness.

ANTI-COUNTERFEITING POLICY

Fairchild Semiconductor Corporation's Anti-Counterfeiting Policy. Fairchild's Anti-Counterfeiting Policy is also stated on our external website, www.fairchildsemi.com, under Sales Support.

Counterfeiting of semiconductor parts is a growing problem in the industry. All manufacturers of semiconductor products are experiencing counterfeiting of their parts. Customers who inadvertently purchase counterfeit parts experience many problems such as loss of brand reputation, substandard performance, failed applications, and increased cost of production and manufacturing delays. Fairchild is taking strong measures to protect ourselves and our customers from the proliferation of counterfeit parts. Fairchild strongly encourages customers to purchase Fairchild parts either directly from Fairchild or from Authorized Fairchild Distributors who are listed by country on our web page cited above. Products customers buy either from Fairchild directly or from Authorized Fairchild Distributors are genuine parts, have full traceability, meet Fairchild's quality standards for handling and storage and provide access to Fairchild's full range of up-to-date technical and product information. Fairchild and our Authorized Distributors will stand behind all warranties and will appropriately address any warranty issues that may arise. Fairchild will not provide any warranty coverage or other assistance for parts bought from Unauthorized Sources. Fairchild is committed to combat this global problem and encourage our customers to do their part in stopping this practice by buying direct or from authorized distributors.

PRODUCT STATUS DEFINITIONS

Definition of Terms

Datasheet Identification	Product Status	Definition
Advance Information	Formative / In Design	Datasheet contains the design specifications for product development. Specifications may change in any manner without notice.
Preliminary	First Production	Datasheet contains preliminary data; supplementary data will be published at a later date. Fairchild Semiconductor reserves the right to make changes at any time without notice to improve design.
No Identification Needed	Full Production	Datasheet contains final specifications. Fairchild Semiconductor reserves the right to make changes at any time without notice to improve the design.
Obsolete	Not In Production	Datasheet contains specifications on a product that is discontinued by Fairchild Semiconductor. The datasheet is for reference information only.

Rev. I44