

**SF1186E-2**

**1575.42 MHz**  
**SAW Filter**

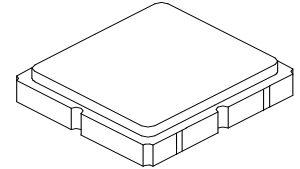

**SM3030-6**

- *Designed for Front-end GPS Applications*
- *Low Insertion Loss*
- *3.0 x 3.0 x 1.3 mm Surface-mount Case*
- *No Matching Circuit Required*
- *Complies with Directive 2002/95/EC (RoHS)*
- *Moisture Sensitivity Level: 1*

**Maximum Ratings at +25 °C Unless Stated Otherwise**

Rating	Symbol	Value	Units
Maximum Input Signal Level		+10	dBm
DC Voltage on any Non-ground Terminal	WVdc	4	Volts
Operating Temperature Range	T <sub>A</sub>	-40 to +95	°C
Storage Temperature Range on Tape and Reel	T <sub>STG</sub>	-40 to +85	°C
Lead Soldering Temperature for 10 Seconds	T <sub>WAVE</sub>	260	°C
Peak Reflow Solder Temp for 40 Seconds	T <sub>Reflow</sub>	235	°C
Suitable for lead-free soldering - Max Soldering Temperature		260°C for 30 s	

**Electrical Characteristics**

Characteristic	Sym	Notes	Min	Typ	Max	Units
Center Frequency	f <sub>O</sub>		1575.42			MHz
1 dB Bandwidth			2.046	15.3		MHz
Passband Amplitude Ripple, f <sub>O</sub> ±2.0 MHz				0.1	2.0	dB <sub>P-P</sub>
Passband VSWR				1.4	2.0	
Insertion Loss				2.68	3.5	dB
Attenuation Referenced to 0 dB:						
850 MHz			45	51.2		dB
1500 MHz			40	52.7		
1535.42 MHz			20	38.9		
1615.42 MHz			20	58.8		
1640 MHz			45	59.1		
1700 MHz			50	56.7		
Temperature Coefficient			-30			ppm/°C
Operating Temperature	T <sub>A</sub>		-40		+95	°C
Single-ended Input /Output Impedance Match	No matching network required for operation at 50 ohms					
Case Style	SM3030-6 3 x 3 mm Nominal Footprint					
Lid Symbolization	Y=year, WW=week, S=shift		979 YWWS			

**Electrical Connections**

Pin #	Description	Pin #	Description
1	Ground	4	Ground
2	Input	5	Output
3	Ground	6	Ground

 **CAUTION: Electrostatic Sensitive Device. Observe precautions for handling.**

**NOTES:**

1. The design, manufacturing process, and specifications of this device are subject to change.
2. US or International patents may apply.
3. RoHS compliant from the first date of manufacture.

## Transfer function :

(1) S21 response (span : 300 MHz)

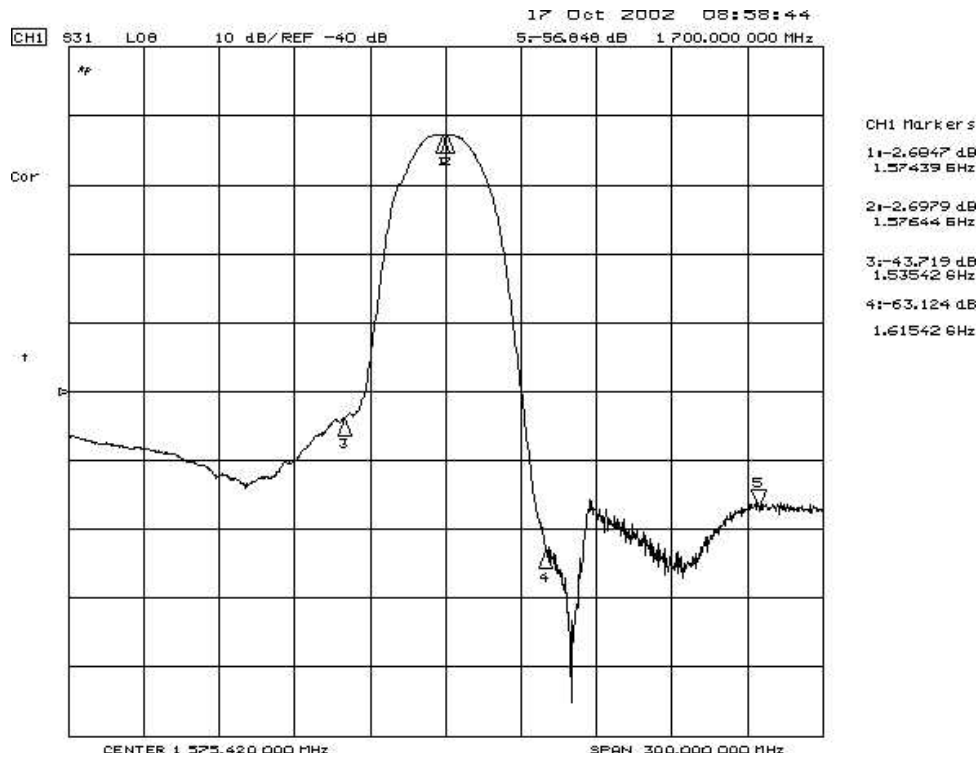

(2) S21 response (span : 3 GHz)

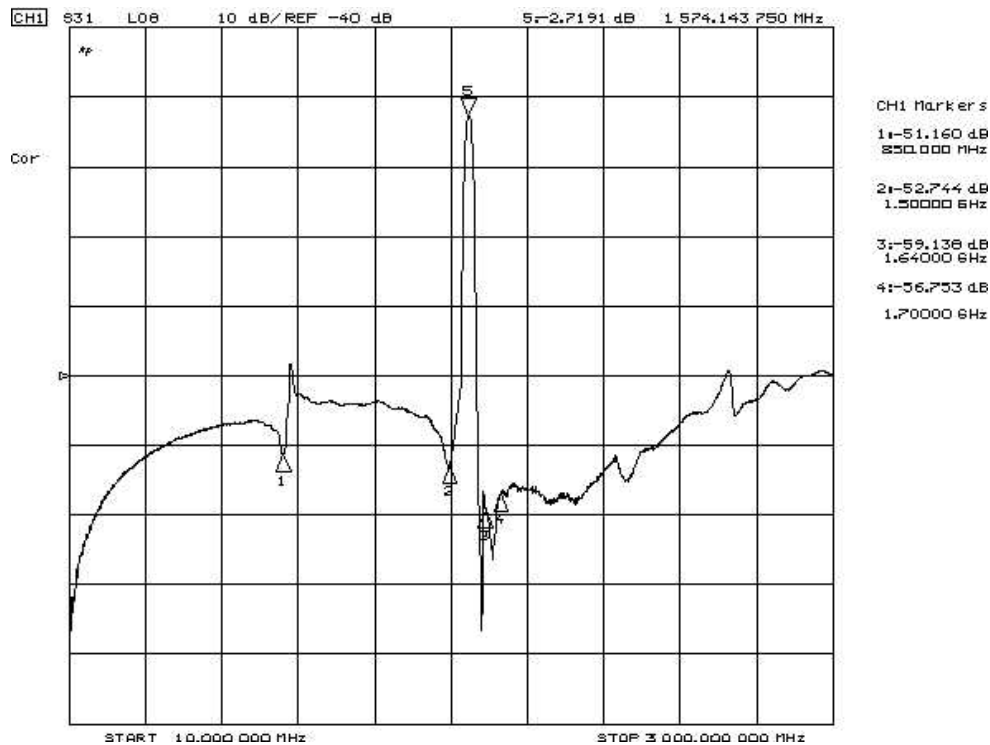

# Reflection Functions:

S11

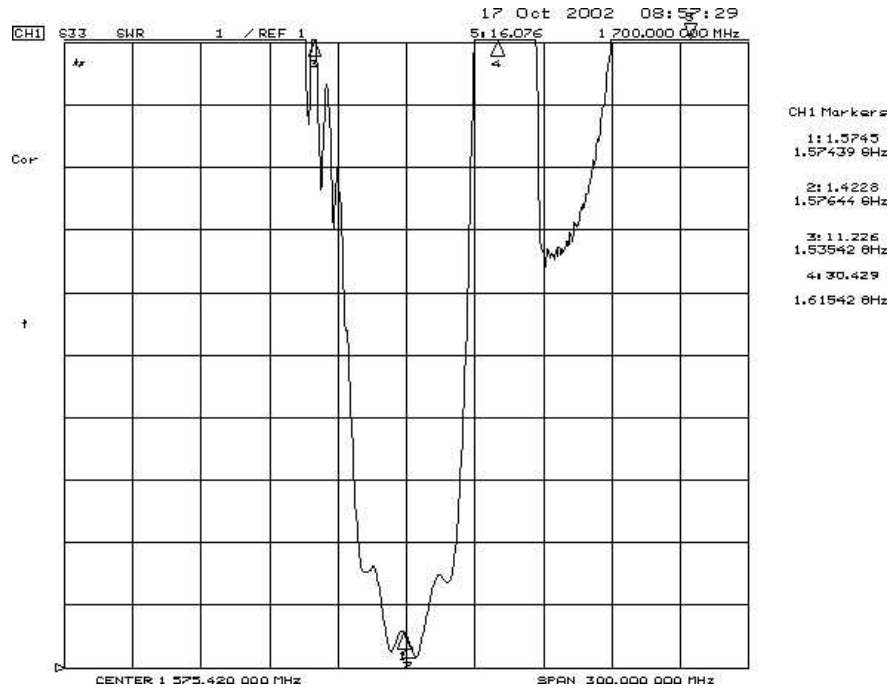

S22

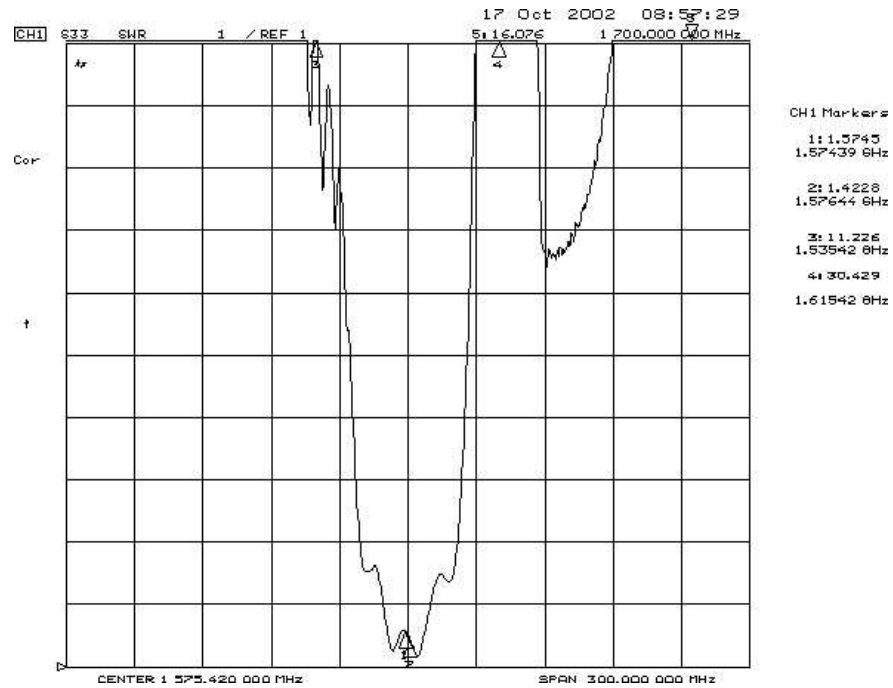

Reflection Functions:

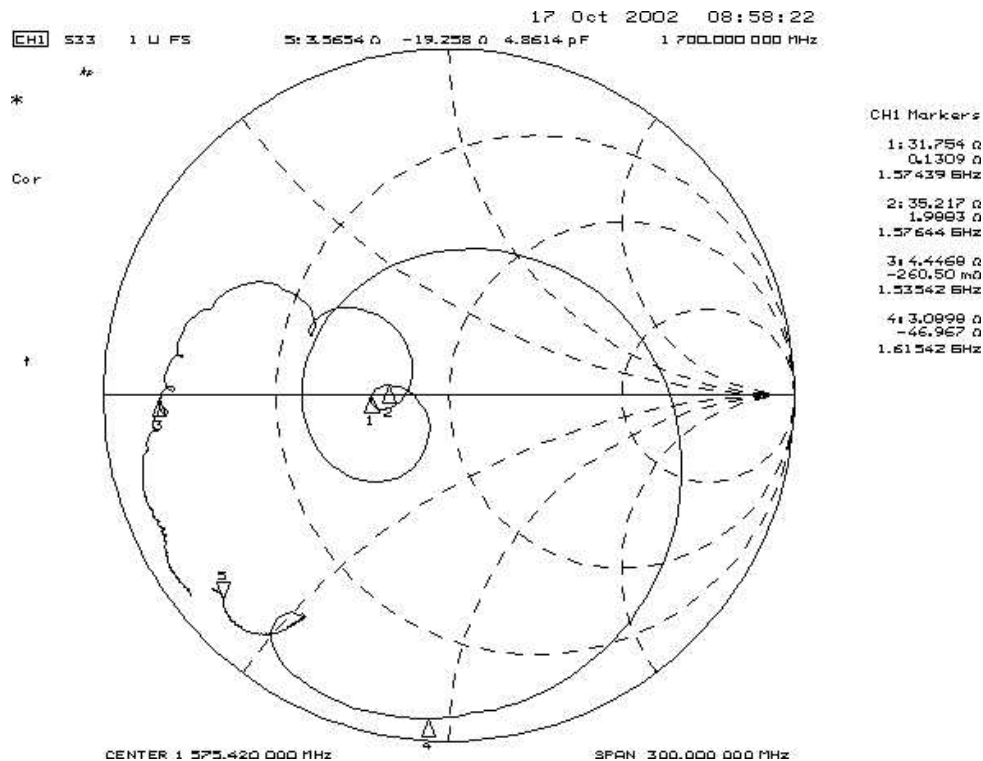
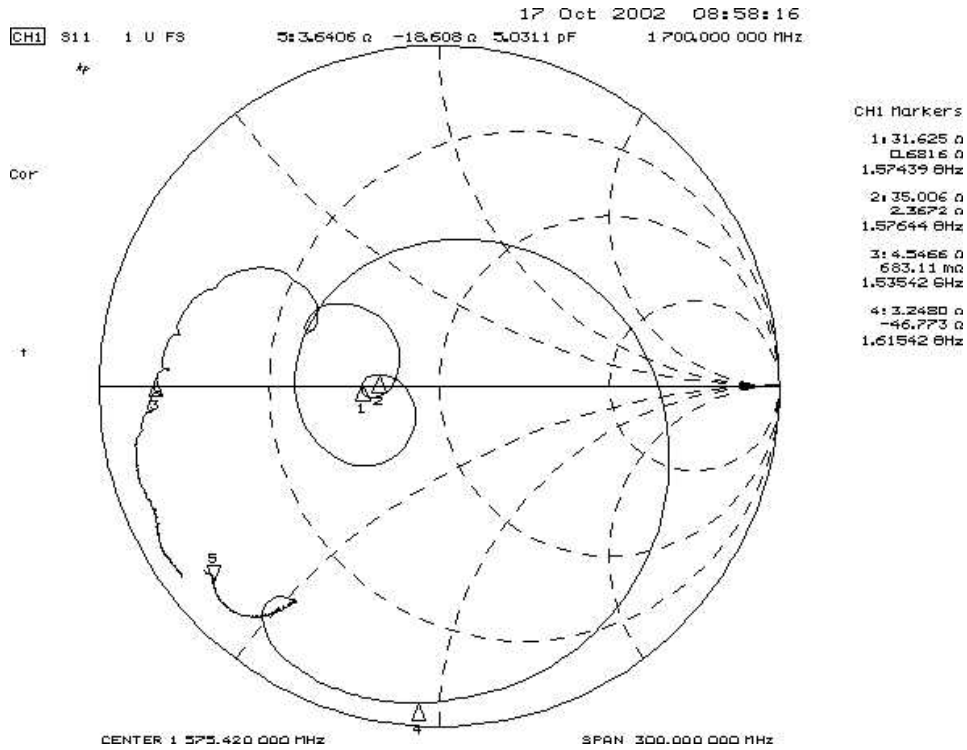

# SM3030-6 Case

## 6-Terminal Ceramic Surface-Mount Case

### 3.0 X 3.0 mm Nominal Footprint

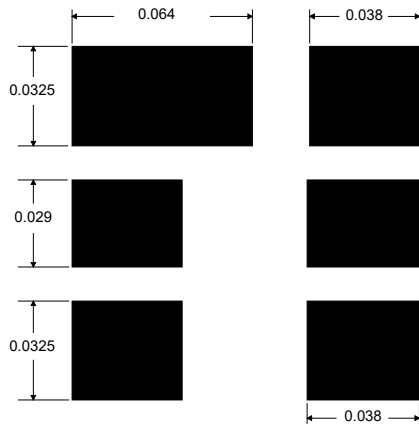
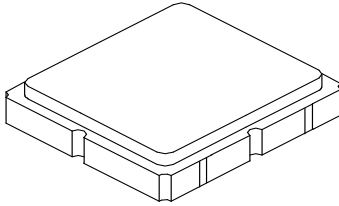

Foot Print Dimensions in Nominal Inches

Case Dimensions						
Dimension	mm			Inches		
	Min	Nom	Max	Min	Nom	Max
A	2.87	3.0	3.13	0.113	0.118	0.123
B	2.87	3.0	3.13	0.113	0.118	0.123
C	1.12	1.25	1.38	0.044	0.049	0.054
D	0.77	0.9	1.03	0.030	0.035	0.040
E	2.67	2.80	2.93	0.105	0.110	0.115
F	1.47	1.6	1.73	0.058	0.063	0.068
G	0.72	0.85	0.98	0.028	0.033	0.038
H	1.37	1.5	1.63	0.054	0.059	0.064
I	0.47	0.6	0.73	0.019	0.024	0.029
J	1.17	1.3	1.43	0.046	0.051	0.056

Electrical Connections		
Connection		Terminals
Port 1	Single-ended Input	2
Port 2	Single-ended Output	5
	Ground	All others
Single-ended Operation Only		
Dot indicates Pin 1		

Case Materials	
Solder Pad Plating	0.3 to 1.0 $\mu\text{m}$ Gold over 1.27 to 8.89 $\mu\text{m}$ Nickel
Lid Plating	2.0 to 3.0 $\mu\text{m}$ Nickel
Body	$\text{Al}_2\text{O}_3$ Ceramic

TOP VIEW

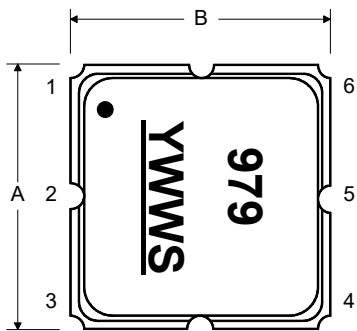

BOTTOM VIEW

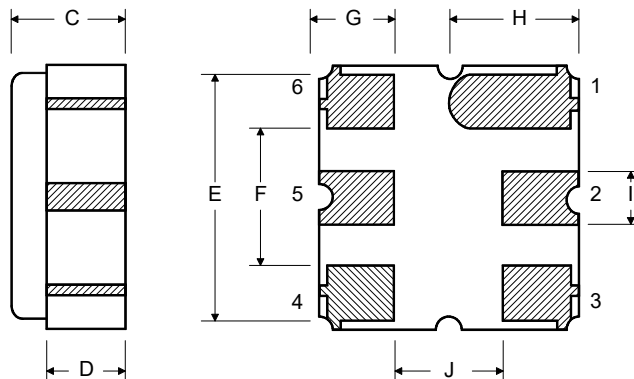

# Tape and Reel Specifications

Tape and Reel Standard per ANSI/EIA-481

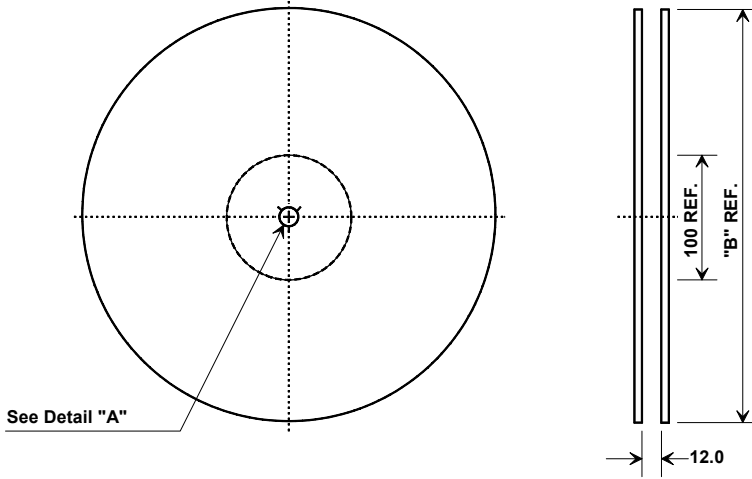

"B"		Quantity Per Reel
Inches	millimeters	
7	178	500
13	330	3000

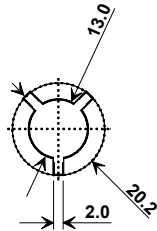

## COMPONENT ORIENTATION

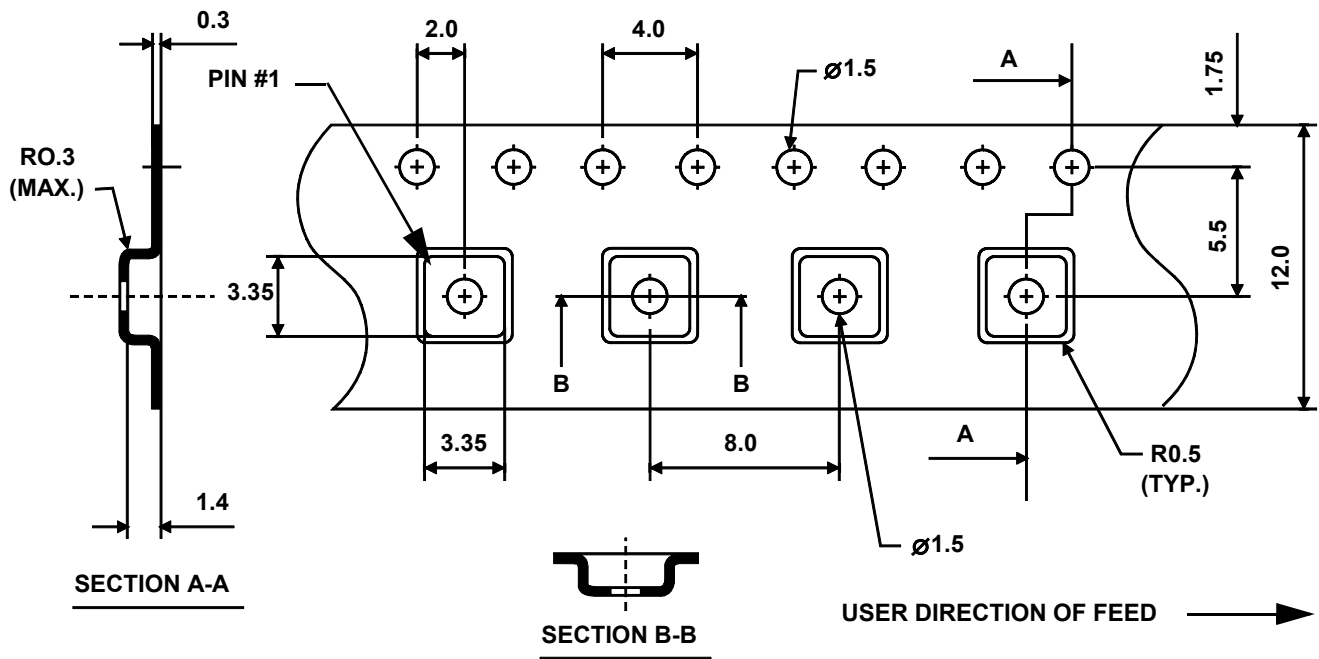

## Recommended Reflow Profile

1. Preheating shall be fixed at 150~180°C for 60~90 seconds.
2. Ascending time to preheating temperature 150°C shall be 30 seconds min.
3. Heating shall be fixed at 220°C for 50~80 seconds and at 260°C+0/-5°C peak (10 seconds).
4. Time: 5 times maximum.

