

FM click™

## 1. Introduction

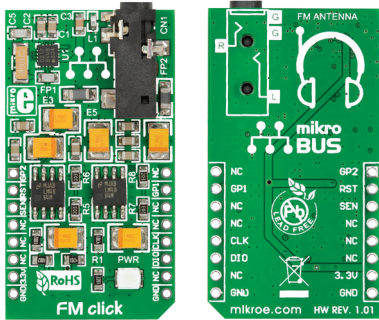

FM Click™ is an accessory board in **mikroBUS™** form factor. It's a compact and easy solution for adding broadcast FM radio tuner to your design. It features **Si4703** FM radio tuner, two **LM4864** audio amplifiers as well as stereo audio connector. FM Click™ communicates with the target board microcontroller via **mikroBUS™** I<sup>2</sup>C (SDA, SCL), INT, RST, CS and AN lines. The board is designed to use 3.3V power supply only. LED diode (GREEN) indicates the presence of power supply.

## 2. Soldering the headers

Before using your click board™, make sure to solder 1x8 male headers to both left and right side of the board. Two 1x8 male headers are included with the board in the package.

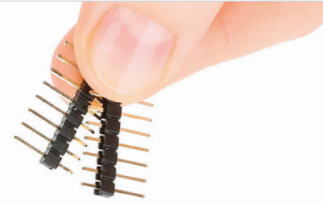

1

2

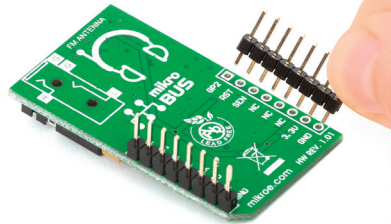

Turn the board upside down so that bottom side is facing you upwards. Place shorter parts of the header pins in both soldering pad locations.

3

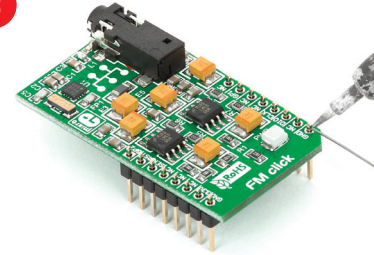

Turn the board upward again. Make sure to align the headers so that they are perpendicular to the board, then solder the pins carefully.

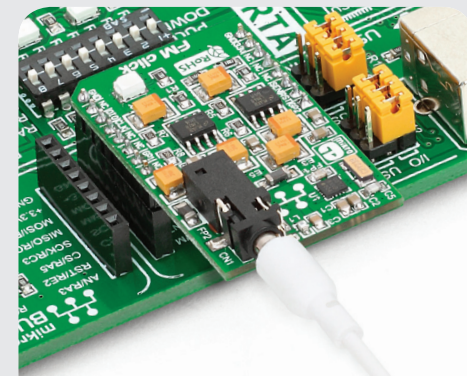

## 4. Essential features

FM Click™ with its **Si4703** IC is a complete FM radio tuner (from antenna input to stereo audio output). It supports worldwide FM band (76 - 108 MHz). The board contains automatic frequency and gain control, RDS/RBDS processor, seek tuning and volume control. All these features make this board ideal for MP3 players, portable radios, PDAs, notebook PCs, portable navigations and many more.

## 3. Plugging the board in

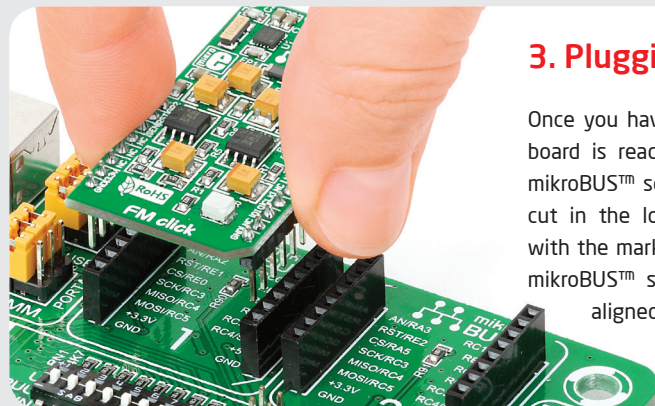

Once you have soldered the headers your board is ready to be placed into desired mikroBUS™ socket. Make sure to align the cut in the lower-right part of the board with the markings on the silkscreen at the mikroBUS™ socket. If all of the pins are aligned correctly, push the board all the way into the socket.

click™  
BOARD  
www.mikroe.com

FM click Manual  
ver. 1.01



0 100000 023785

## 5. FM Click™ Board Schematic

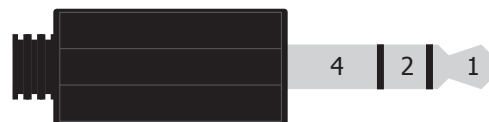
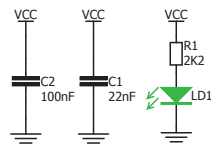
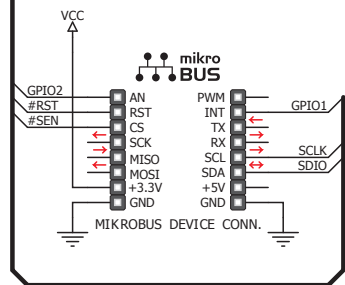
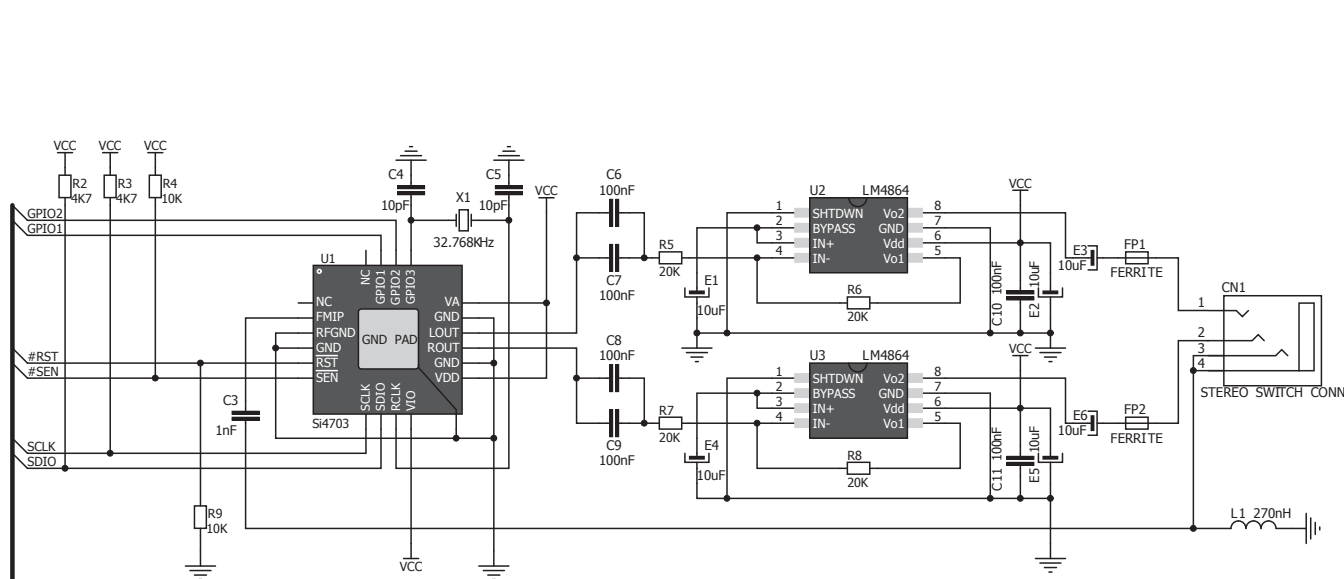

Pin Number	1	2	4
Description	Left Audio	Right Audio	Antenna



Pin Number	1	2	3	4
Description	Left Audio	Right Audio	Antenna	Antenna

## 6. Earphones and antenna



FM antenna is provided through the earphones cable (recommended length between 1.1 and 1.45 m). The board supports 3 and 4 conductor earphones with pinout as shown in schematic. Earphones are not included in the package

## 7. Code Examples

Once you have done all the necessary preparations, it's time to get your click board up and running. We have provided the examples for mikroC, mikroBasic and mikroPascal compilers on our [Libstock](http://www.libstock.com) website. Just download them and you are ready to start.



## 8. Support

MikroElektronika offers **Free Tech Support** ([www.mikroe.com/esupport](http://www.mikroe.com/esupport)) until the end of product lifetime, so if something goes wrong, we are ready and willing to help!

