

**FMW-2106**

Mar. 2008

Schottky Barrier Rectifier

**General Description**

FMW-2106 is a Schottky Barrier Diode, and has achieved low leakage current and low VF by selecting the best barrier metal.

**Applications**

- DC-DC converters
- AC adapter
- High frequency rectification circuit

**Features**

- Super-high speed & low noise switching.
- Low forward voltage drop.

**Package**

TO220F(3Pin)

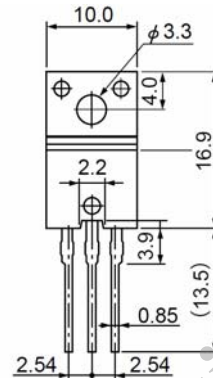

**Key Specifications**

Symbol	Unit	Rating	Conditions
$V_{RM}$	V	60	
$V_F$	V	0.70	$I_F=5.0A$
$I_{F(AV)}$	A	10	

**Typical Characteristics**

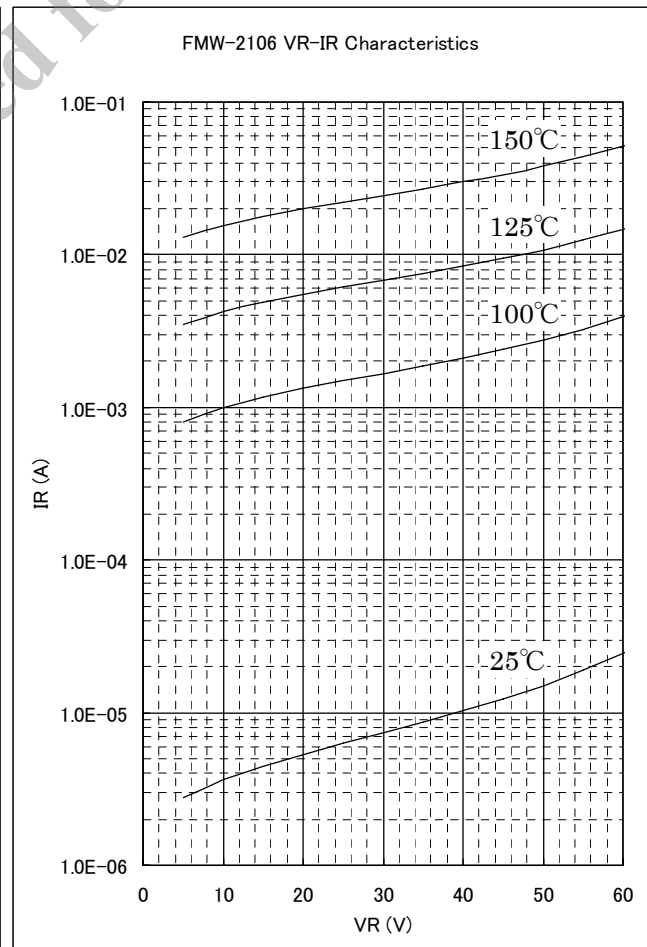
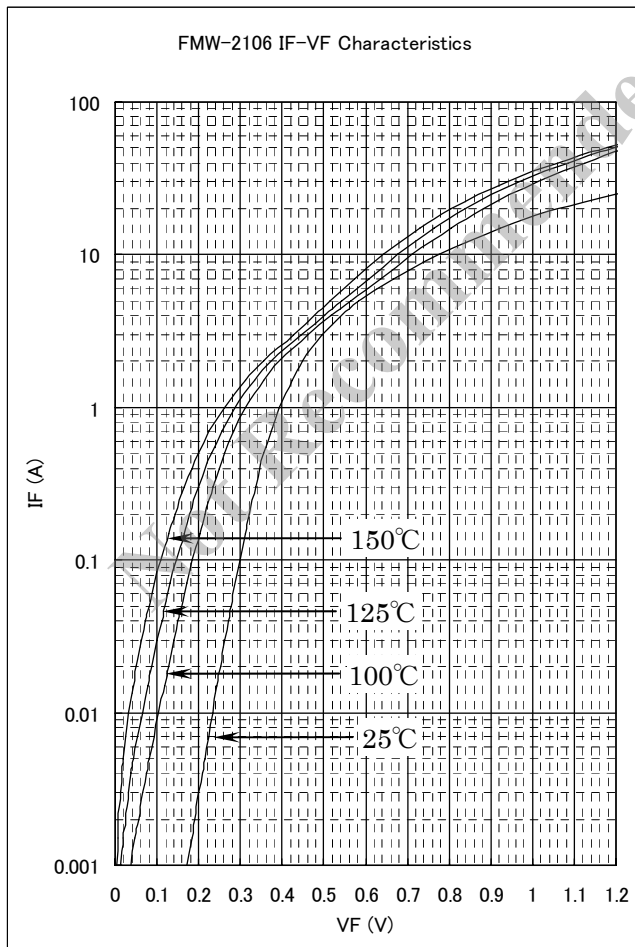

The information included herein is believed to be accurate and reliable. However, SANKEN ELECTRIC CO., LTD assumes no responsibility for its use ; nor for any infringements of patents or other rights of third parties that may result from its use.

**FMW-2106**

Mar. 2008

Schottky Barrier Rectifier

**\* Absolute maximum ratings**

No.	Parameter	Symbol	Unit	Rating	Conditions
1	Transient Peak Reverse Voltage	$V_{RSM}$	V	60	
2	Peak Reverse Voltage	$V_{RM}$	V	60	
3	Average Forward Current	$I_{F(AV)}$	A	10	
4	Peak Surge Forward Current	$I_{FSM}$	A	100	Half sinewave, one shot
5	$I^2t$ Limiting Value	$I^2t$	$A^2s$	50	$1msec < t < 10msec$
6	Junction Temperature	$T_j$	$^{\circ}C$	-40 to +150	
7	Storage Temperature	$T_{stg}$	$^{\circ}C$	-40 to +150	

No.1,2,4&5 show ratings per one chip.

**\* Electrical characteristics ( $T_a=25^{\circ}C$ , unless otherwise specified)**

No.	Parameter	Symbol	Unit	Rating	Conditions
1	Forward Voltage Drop	$V_F$	V	0.70 max.	$I_F=5.0A$
2	Reverse Leakage Current	$I_R$	mA	3.0 max.	$V_R=V_{RM}$
3	Reverse Leakage Current Under High Temperature	$H \cdot I_R$	mA	125 max.	$V_R=V_{RM}, T_j=150^{\circ}C$
4	Thermal Resistance	$R_{th(j-c)}$	$^{\circ}C/W$	4.0 max.	Between Junction and case

No.1,2,&3 show characteristics per one chip.

The information included herein is believed to be accurate and reliable. However, SANKEN ELECTRIC CO., LTD assumes no responsibility for its use ; nor for any infringements of patents or other rights of third parties that may result from its use.

**FMW-2106**

Schottky Barrier Rectifier

Mar. 2008

★ **Characteristics**

**Forward Power Dissipation**

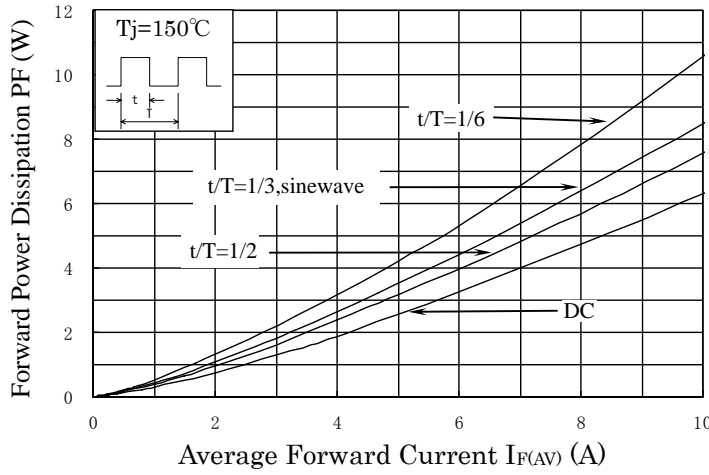

**Reverse Power Dissipation**

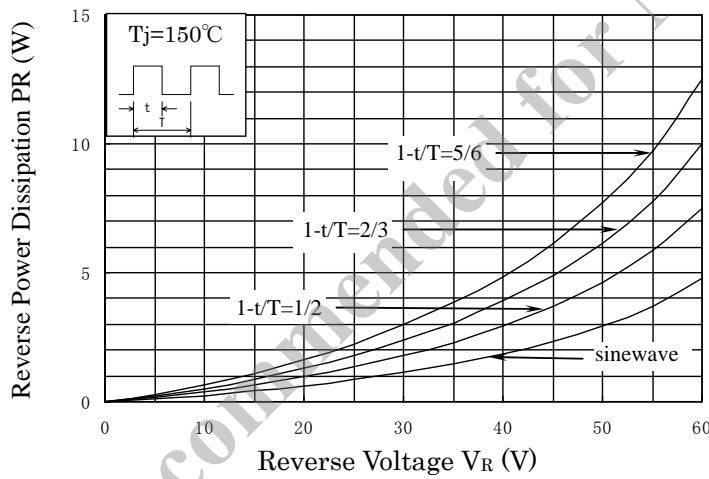

**Current Derating**  $V_R=60\text{V}$

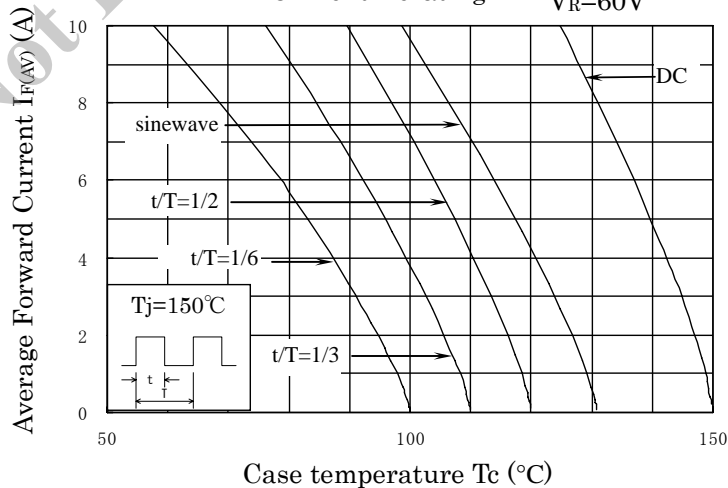

**FMW-2106**

Mar. 2008

Schottky Barrier Rectifier

★ Outline drawings, mm

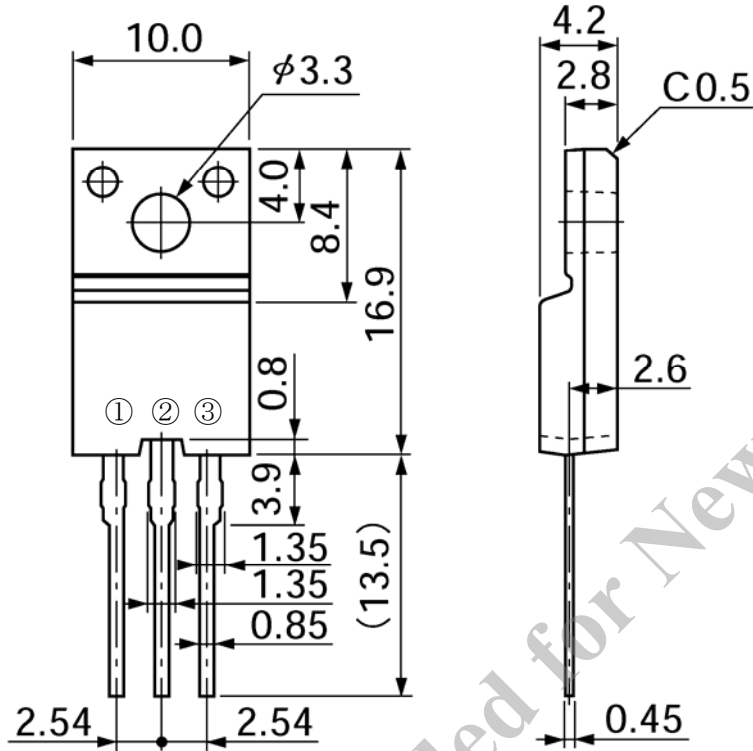

tolerance:±0.2

★ Connection Diagram

