

**SF2162E**

**1178.12 MHz**  
**SAW Filter**

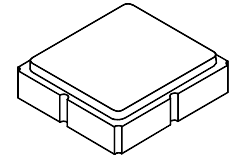

**SM3030-8**

- SAW Filter for Digital Television
- Complies with Directive 2002/95/EC (RoHS)
- Moisture Sensitivity Level: 1

**Characteristics :**

Balance-to-balanced Operation

Terminating Source/Load Impedance :  $Z_S = 150 \Omega$

**Maximum Rating**

Rating	Value	Units
Input Power Level	10	dBm
DC Voltage on any Non-ground Terminal	3	V
Operating Temperature Range	-40 to +85	°C
Storage Temperature Range in Tape and Reel	-50 to +95	°C
Maximum Soldering Profile, 5 cycles/ 10 seconds maximum	265	°C

**Electrical Characteristics**

Characteristic	Sym	Notes	Min	Typ	Max	Units
Center Frequency	$f_C$			1178.12		MHz
1.5 dB Passband				50		
Bandwidth at -2dB			40	55		
Maximum Insertion Loss, 1158.12 to 1198.12 MHz	$IL_{MAX}$			2.5	5.0	dB
Amplitude Ripple, 1158.12 to 1198.12 MHz				0.9	2.0	
Phase error 1158.12 to 1198.12 MHz				3.0	5.5	deg
I/O VSWR 1158.12 to 1198.12 MHz				1.7	2.5	
Attenuation, Referenced to $IL_{MAX}$						dB
50 to 1096.06 MHz			42	55		
1260.18 to 2000 MHz			42	50		
2000 to 3500MHz			35	44		
3500 to 6000 MHz			22	26		
Group Delay Ripple, 1158.12 to 1198.12 MHz				12	35	nSp_p

Case Style	SM3030-8 3.0 x 3.0 mm Nominal Footprint
Lid Symbolization (Y=year, WW=week, S=shift) dot=pin 1 indicator	857, YWWS

**Electrical Connections**

	Connection	Terminals
Port 1	Balanced Input	1,2
Port 2	Balanced Output	5,6
	Ground	All Others

Dot Indicates Pin 1



**CAUTION: Electrostatic Sensitive Device. Observe precautions for handling.**

**NOTES:**

1. The design, manufacturing process, and specifications of this device are subject to change.
2. US or International patents may apply.
3. RoHS compliant from the first date of manufacture.

# Filter $S_{11}$ , and $S_{22}$

$S_{11}$

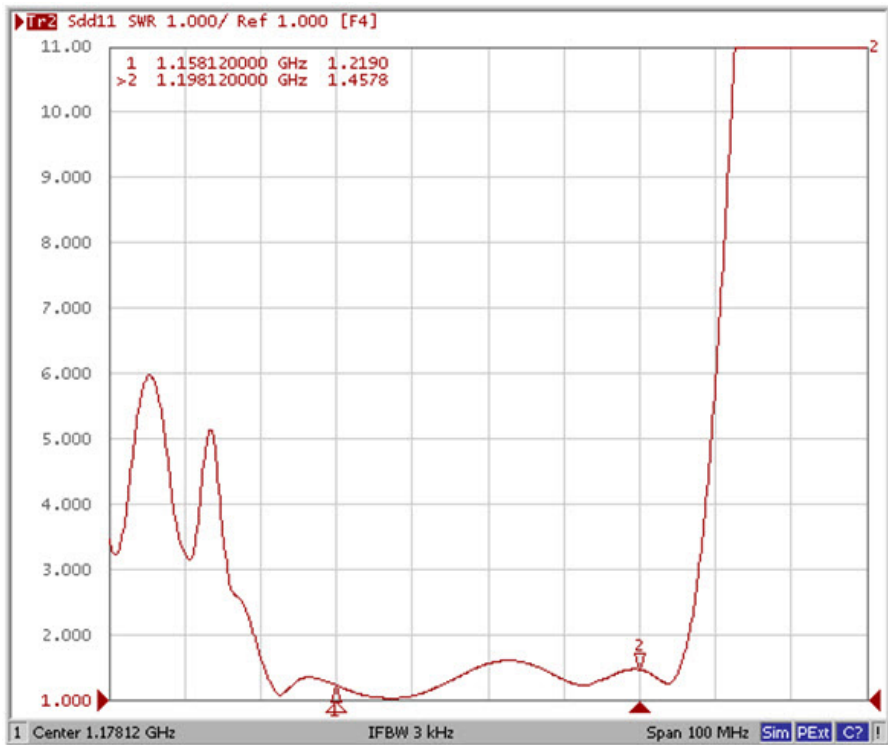

$S_{22}$

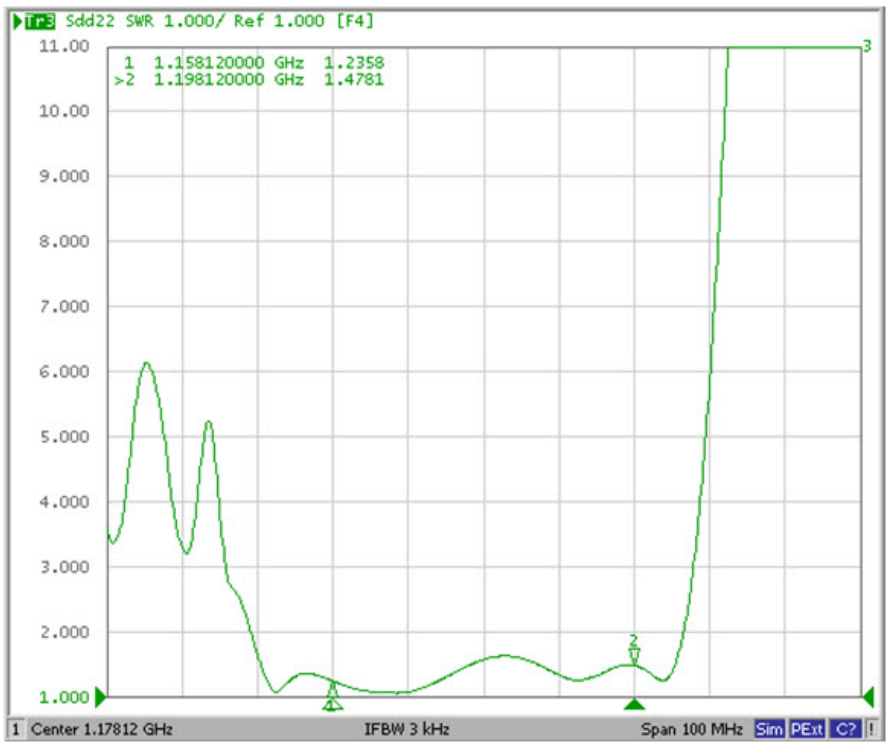

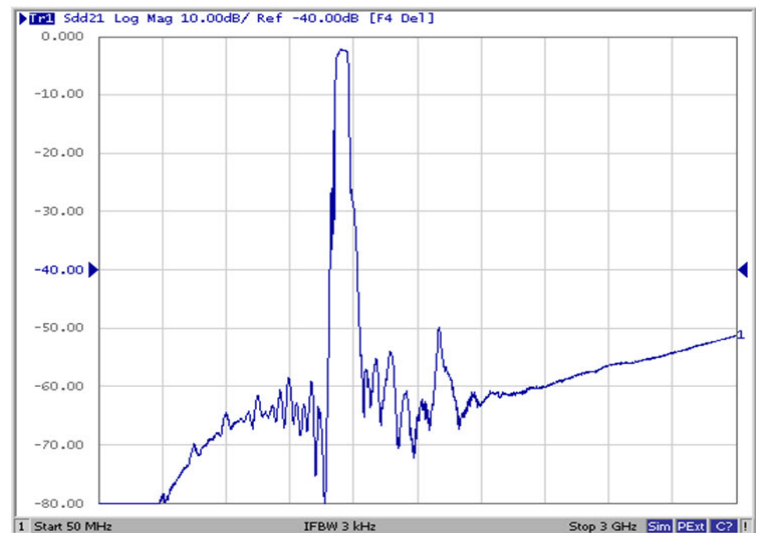
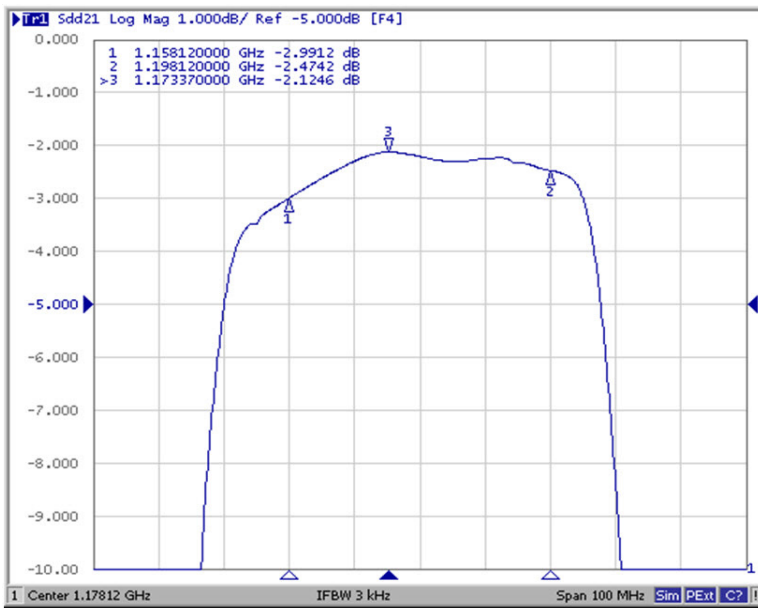

## Tuning Network, 150 ohm Balanced Source/Load

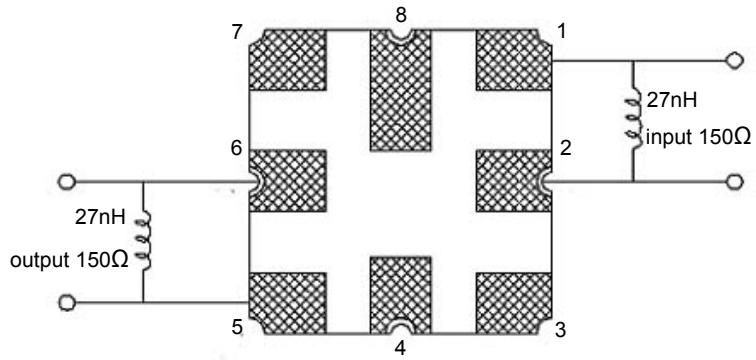

## 8-Terminal Ceramic Surface-Mount Case 3.0 X 3.0 mm Nominal Footprint

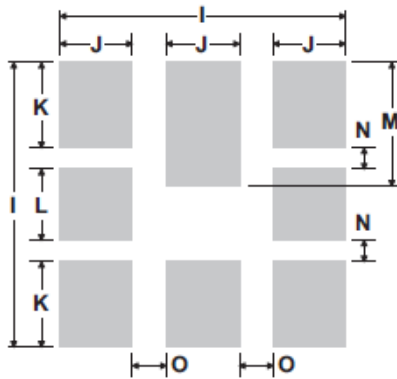
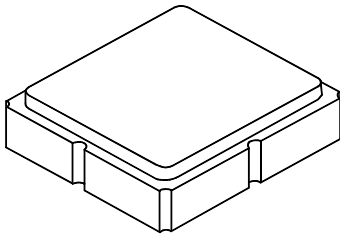

**PCB Footprint Top View**

### Case and PCB Footprint Dimensions

Dimension	mm			Inches		
	Min	Nom	Max	Min	Nom	Max
A	2.87	3.0	3.13	0.113	0.118	0.123
B	2.87	3.0	3.13	0.113	0.118	0.123
C	1.14	1.27	1.10	0.045	0.050	0.043
D	0.79	0.92	1.05	0.031	0.036	0.041
E	0.62	0.75	0.88	0.024	0.029	0.034
F	0.47	0.60	0.73	0.018	0.024	0.029
G	0.47	0.60	0.73	0.018	0.024	0.029
H	1.07	1.20	1.33	0.042	0.047	0.052
I		3.20			0.125	
J		0.81			0.032	
K		0.96			0.038	
L		0.81			0.032	
M		1.39			0.055	
N		0.23			0.009	
O		0.38			0.015	

### Case Materials

Materials	
Solder Pad Plating	0.3 to 1.0 $\mu\text{m}$ Gold over 1.27 to 8.89 $\mu\text{m}$ Nickel
Lid Plating	2.0 to 3.0 $\mu\text{m}$ Nickel
Body	$\text{Al}_2\text{O}_3$ Ceramic

**TOP VIEW**

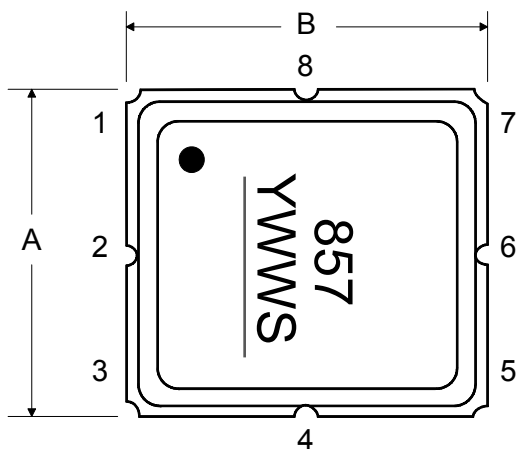

**BOTTOM VIEW**

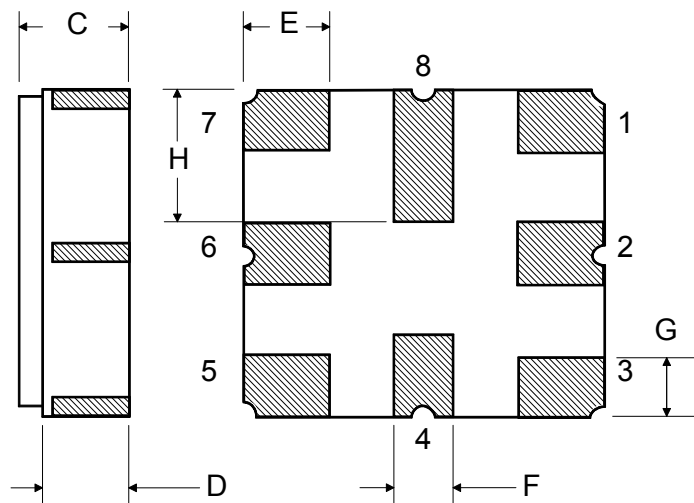

## Tape and Reel Specifications

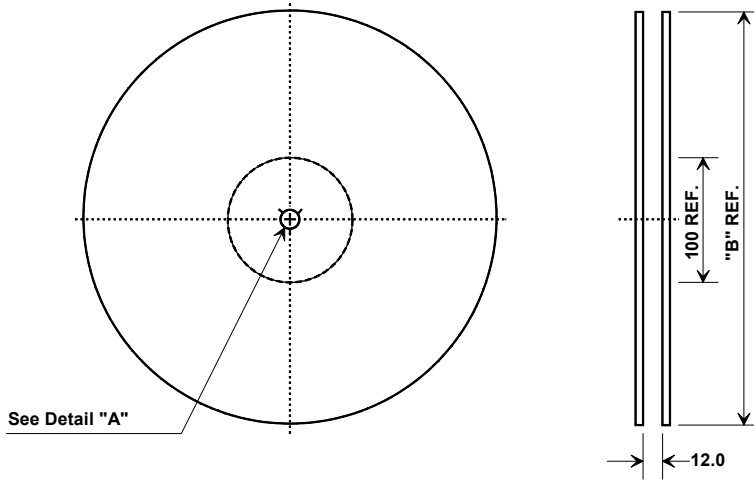

Tape and Reel Standard per ANSI/EIA-481

"B"		Quantity Per Reel
Inches	millimeters	
7	178	500
13	330	3000

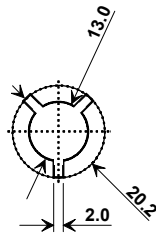

### COMPONENT ORIENTATION and DIMENSIONS

Carrier Tape Dimensions	
Ao	3.35 mm
Bo	3.35 mm
Ko	1.40 mm
Pitch	8.0 mm
W	12.0 mm

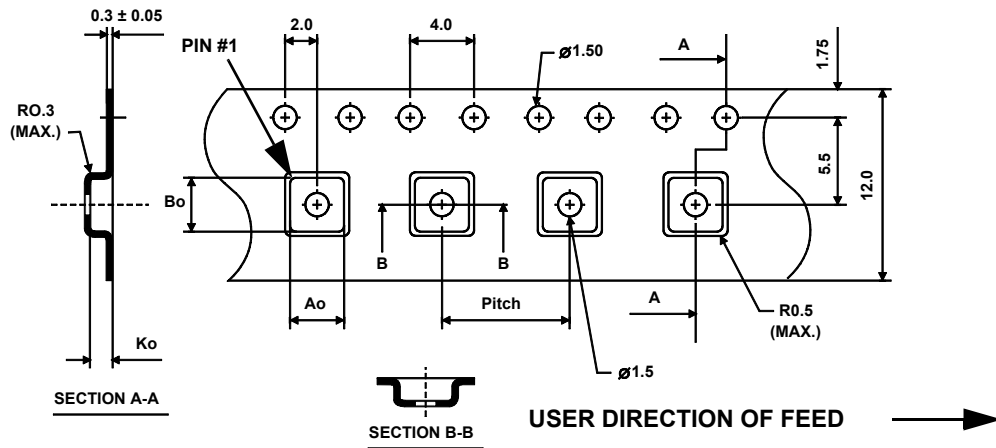

## Recommended Reflow Profile

1. Preheating shall be fixed at 150~180°C for 60~90 seconds.
2. Ascending time to preheating temperature 150°C shall be 30 seconds min.
3. Heating shall be fixed at 220°C for 50~80 seconds and at 260°C +0/-5°C peak (10 seconds).
4. Time: 5 times maximum.

