

NOTES:

1. ROHS COMPLIANT
2. HEADER: THERMOSET PLASTIC MATERIAL WITH FLAMMABILITY RATING UL 94V-0 OR BETTER.
3. STORAGE TEMPERATURE: -20°C TO +125°C
4. COMPLIANCE TO J-STD:
 - A. J-STD-002: SOLDERABILITY AT 245°C REFLOW PROFILE
 - B. J-STD-020: LEVEL 1, NO MOISTURE SENSITIVE
 - C. J-STD-075: R7, 245°C MAXIMUM THROUGH REFLOW SOLDER
5. TO ORDER TAPE & REEL PACKAGING ADD A "T" SUFFIX TO THE PART NUMBER(i.e H7008NL BECOMES H7008NLT).

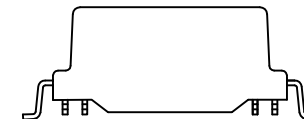
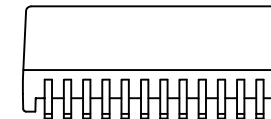
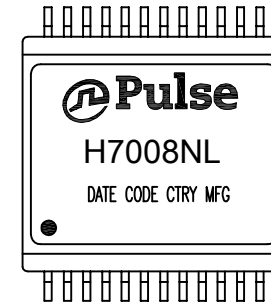

FINAL OUTLINE

© Copyright, 2015. Pulse Electronics Corp. All rights reserved. Pulse confidential & proprietary. (07/30/15)

PRODUCT DESCRIPTION	TLA DRAWING	PS DRAWING	SHEET	PART NO.	DATASHEET REV.
MDL,SIN,10G,1:1,SM,OH	H7008NL-14	PS-2517.001-A	1 OF 3	H7008NL	A

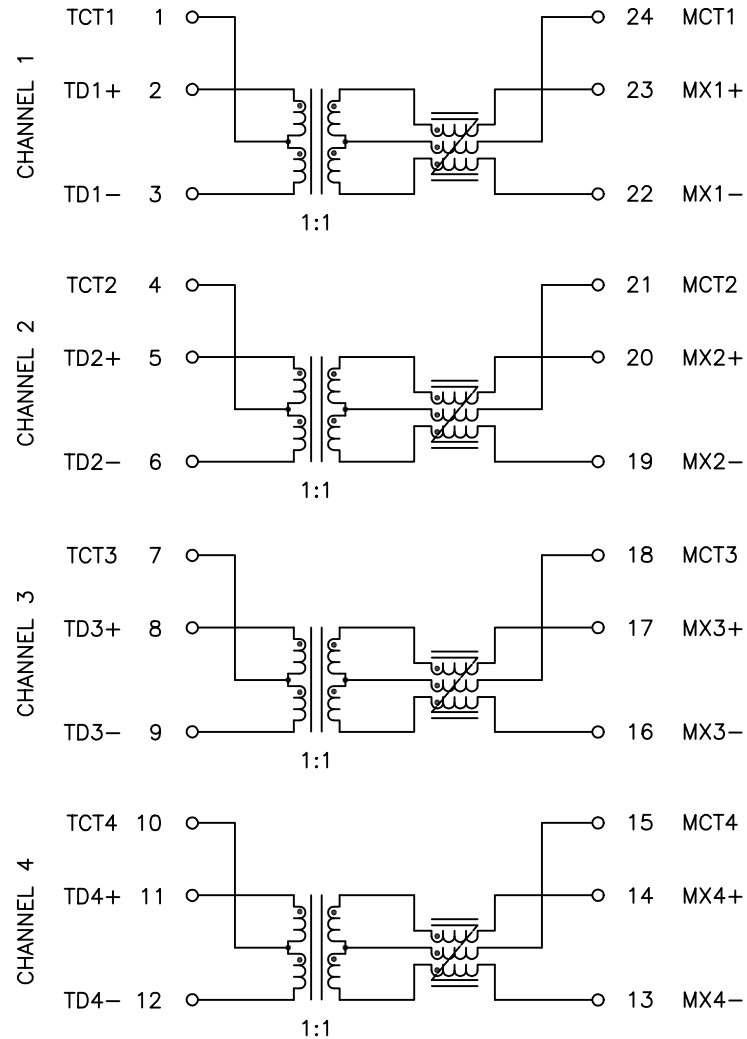

SCHEMATIC

ELECTRICAL CHARACTERISTICS AT +25°C UNLESS OTHER SPECIFIED
MEETS IEEE 802.3 SPECIFICATION

PARAMETER	SPECIFICATIONS		
OPERATING TEMP	0°C – 70°C		
TURNS RATIO	1.00 ± 2%		
POLARITY	PER SCHEMATIC		
INSERTION LOSS	100 KHz	1–500 MHz	
	–3.0 dB MAX	–1.0 dB MAX (–.6 dB TYP)	
RETURN LOSS (Z OUT = 100 OHM ± 1%)	1–40 MHz	40 MHz–500 MHz	
	–18 dB MIN	–17 + 10*LOG (f/40)	
INDUCTANCE (OCL)	200 uH MIN @ 100 kHz, 100 mV		
CROSSTALK, ADJACENT CHANNELS	1–100 MHz	100–500 MHz	
	–40 dB MIN	–30 dB MIN	
COMMON MODE REJECTION RATIO	1–100 MHz	100–300 MHz	300–500 MHz
	–35 dB MIN	–30 dB MIN	–25 dB MIN
	COMMON TO DIFFERENTIAL MODE REJECTION (CDMR)		
	1–250 MHz	250–500 MHz	
	–30 dB MIN	–22 dB MIN	
INPUT – OUTPUT ISOLATION	1500 VRMS MIN @ 60 SECONDS		

NOTE: f IS FREQUENCY IN MHZ.

© Copyright, 2015. Pulse Electronics Corp. All rights reserved. Pulse confidential & proprietary. (07/30/15)

PRODUCT DESCRIPTION	TLA DRAWING	PS DRAWING	SHEET	PART NO.	DATASHEET REV.
MDL,SIN,10G,1:1,SM,OH	H7008NL-14	PS-2517.001-A	2 OF 3	H7008NL	A

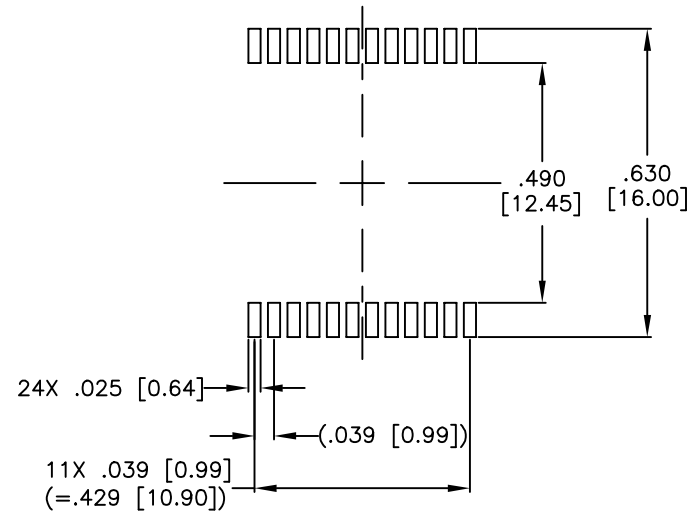
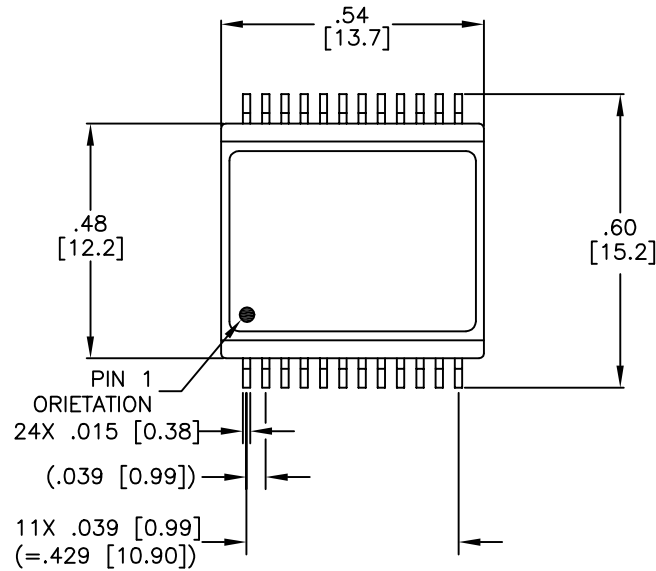

SUGGESTED LAND PATTERN

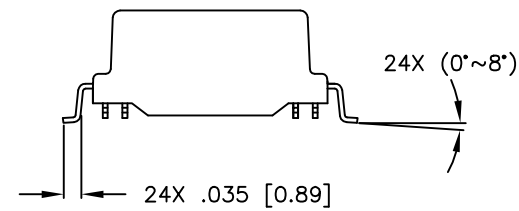
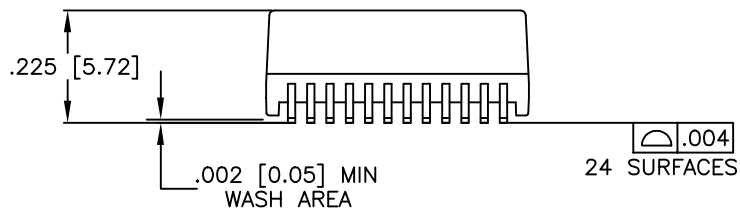

DIMENSIONS ARE IN INCHES [MILLIMETERS] WITH THE FOLLOWING TOLERANCES: [MILLIMETERS] ARE FOR REFERENCE ONLY.
.XX= ±.02 [±0.50]
.XXX= ±.010 [±0.25]

© Copyright, 2015. Pulse Electronics Corp. All rights reserved. Pulse confidential & proprietary. (07/30/15)

PRODUCT DESCRIPTION	TLA DRAWING	PS DRAWING	SHEET	PART NO.	DATASHEET REV.
MDL,SIN,10G,1:1,SM,OH	H7008NL-14	PS-2517.001-A	3 OF 3	H7008NL	A