



STN4NF20L

N-channel 200 V, 1.1 Ω , 1 A SOT-223
low gate charge STripFET™ II Power MOSFET

Features

Order code	V _{DSS}	R _{DS(on)} max.	I _D
STN4NF20L	200 V	< 1.5 Ω	1 A

- 100% avalanche tested
- Low gate charge
- Exceptional dv/dt capability

Application

Switching applications

Description

This N-channel 200 V realized with STMicroelectronics unique STripFET™ process has specifically been designed to minimize input capacitance and gate charge. It is therefore suitable as primary switch in advanced high efficiency isolated DC-DC converters.

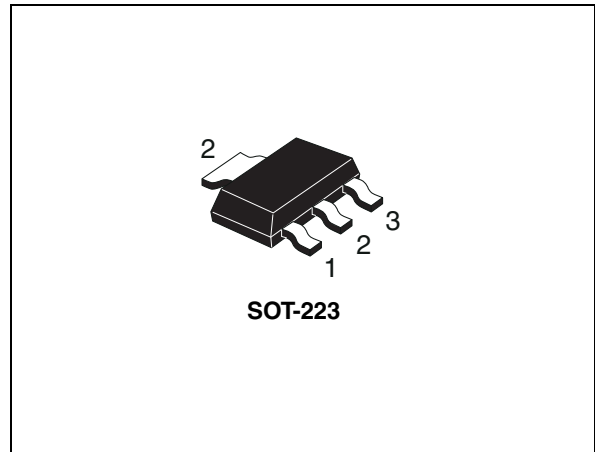

Figure 1. Internal schematic diagram

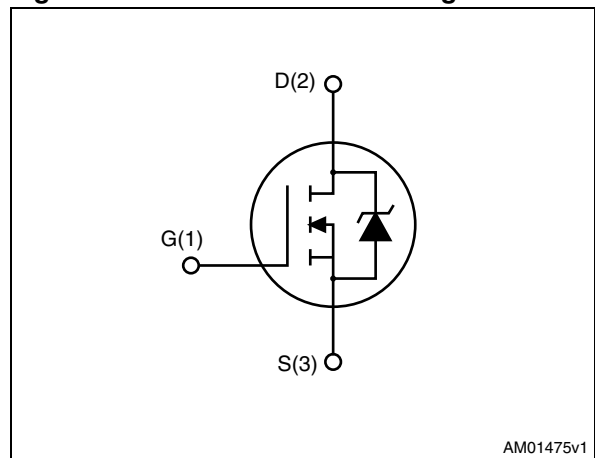

Table 1. Device summary

Order code	Marking	Package	Packaging
STN4NF20L	4NF20L	SOT-223	Tape and reel

Contents

1	Electrical ratings	3
2	Electrical characteristics	4
	2.1 Electrical characteristics (curves)	6
3	Test circuits	8
4	Package mechanical data	9
5	Revision history	11

1 Electrical ratings

Table 2. Absolute maximum ratings

Symbol	Parameter	Value	Unit
V_{GS}	Gate-source voltage	± 20	V
I_D	Drain current continuous $T_C = 25\text{ }^\circ\text{C}$	1	A
I_D	Drain current continuous $T_C = 100\text{ }^\circ\text{C}$	0.63	A
$I_{DM}^{(1)}$	Drain current pulsed	4	A
$P_{TOT}^{(2)}$	Total dissipation at $T_C = 25\text{ }^\circ\text{C}$	3.3	W
$dv/dt^{(3)}$	Peak diode recovery voltage slope	20	V/ns
T_j T_{stg}	Operating junction temperature Storage temperature	- 55 to 150	$^\circ\text{C}$

1. Pulse width limited by safe operating area.
2. This value is rated according to $R_{thj-amb} \leq 10\text{ sec}$.
3. $I_{sd} \leq 1\text{ A}$, $di/dt \leq 200\text{ A}/\mu\text{s}$, $V_{DD} \leq 80\% V_{(BR)DSS}$.

Table 3. Thermal data

Symbol	Parameter	Value	Unit
$R_{thj-amb}^{(1)}$	Thermal resistance junction to ambient	38	$^\circ\text{C}/\text{W}$
$R_{thj-amb}^{(2)}$		62.5	$^\circ\text{C}/\text{W}$

1. When mounted on 1 inch² FR-4 board, 2 oz. Cu, ($t < 10\text{ sec}$).
2. When mounted on 1 inch² FR-4 board, 2 oz. Cu, ($t > 10\text{ sec}$).

Table 4. Thermal data

Symbol	Parameter	Value	Unit
I_{AR}	Avalanche current, repetitive or not repetitive ⁽¹⁾	1	A
E_{AS}	Single pulse avalanche energy ⁽²⁾	90	mJ

1. Pulse width limited by T_{JMAX} .
2. Starting $T_j = 25\text{ }^\circ\text{C}$, $I_D = I_{AR}$, $V_{DD} = 50\text{ V}$.

2 Electrical characteristics

(T_{case} = 25 °C unless otherwise specified)

Table 5. On /off states

Symbol	Parameter	Test conditions	Min.	Typ.	Max.	Unit
V _{(BR)DSS}	Drain-source breakdown voltage	I _D = 1 mA, V _{GS} = 0	200			V
I _{DSS}	Zero gate voltage drain current (V _{GS} = 0)	V _{DS} = Max rating V _{DS} = Max rating, T _C =125 °C			1 50	μA μA
I _{GSS}	Gate-body leakage current (V _{DS} = 0)	V _{GS} = ± 20 V, V _{DS} =0			± 100	nA
V _{GS(th)}	Gate threshold voltage	V _{GS} = V _{DS} , I _D = 250 μA	1	2	3	V
R _{DS(on)}	Static drain-source on resistance	V _{GS} = 10 V, I _D = 0.5 A V _{GS} = 5 V, I _D = 0.5 A		1.1 1.13	1.5 1.55	Ω Ω

Table 6. Dynamic

Symbol	Parameter	Test conditions	Min.	Typ.	Max.	Unit
C _{iss}	Input capacitance	V _{DS} = 25 V, f = 1 MHz, V _{GS} = 0	-	150	-	pF
C _{oss}	Output capacitance			30		pF
C _{rss}	Reverse transfer capacitance			4		pF
R _g	Intrinsic gate resistance	f=1 MHz open drain	-	5.5	-	Ω
Q _g	Total gate charge	V _{DD} = 160 V, I _D = 1 A, V _{GS} = 10 V (see Figure 13)	-	0.9	-	nC
Q _{gs}	Gate-source charge			2.6		nC
Q _{gd}	Gate-drain charge			6.9		nC

Table 7. Switching times

Symbol	Parameter	Test conditions	Min.	Typ.	Max	Unit
t _{d(v)}	Voltage delay time	V _{DD} = 100 V, I _D = 0.5 A, R _G = 4.7 Ω, V _{GS} = 10 V (see Figure 12)	-	3.6	-	ns
t _r	Voltage rise time			2		ns
t _f	Current fall time			10.4		ns
t _{c(off)}	Crossing time			15.4		ns

Table 8. Source drain diode

Symbol	Parameter	Test conditions	Min.	Typ.	Max.	Unit
I_{SD} $I_{SDM}^{(1)}$	Source-drain current Source-drain current (pulsed)		-		1 4	A A
$V_{SD}^{(2)}$	Forward on voltage	$I_{SD} = 1\text{ A}$, $V_{GS} = 0$	-		1.6	V
t_{rr} Q_{rr} I_{RRM}	Reverse recovery time Reverse recovery charge Reverse recovery current	$I_{SD} = 1\text{ A}$, $di/dt = 100\text{ A}/\mu\text{s}$ $V_{DD} = 60\text{ V}$ (see Figure 14)	-	51 90 3.5		ns nC A
t_{rr} Q_{rr} I_{RRM}	Reverse recovery time Reverse recovery charge Reverse recovery current	$I_{SD} = 1\text{ A}$, $di/dt = 100\text{ A}/\mu\text{s}$ $V_{DD} = 60\text{ V}$, $T_j = 150\text{ }^\circ\text{C}$ (see Figure 14)	-	56 105 3.7		ns nC A

1. Pulse width limited by safe operating area
2. Pulsed: pulse duration = 300 μs , duty cycle 1.5%

2.1 Electrical characteristics (curves)

Figure 2. Safe operating area

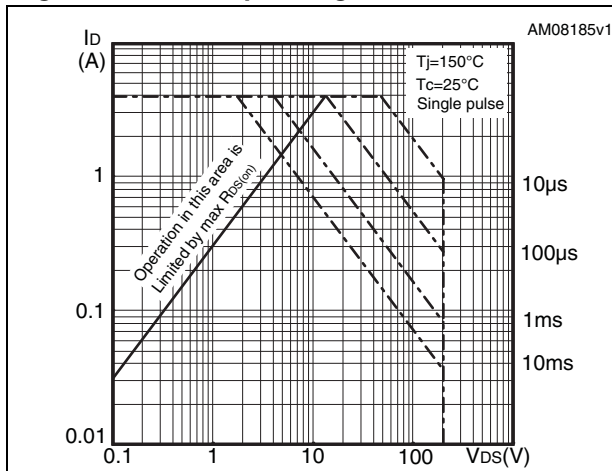

Figure 3. Thermal impedance

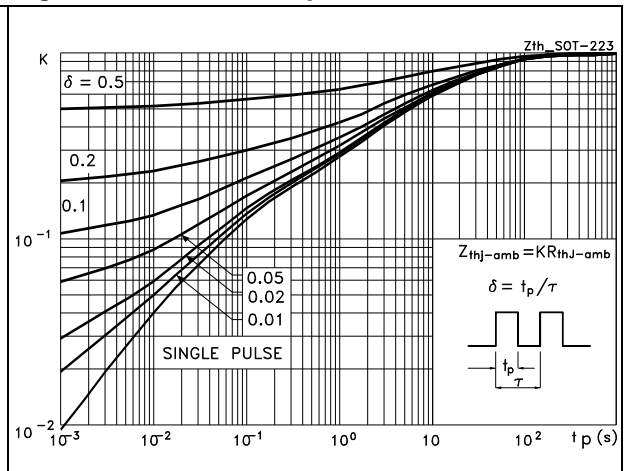

Figure 4. Output characteristics

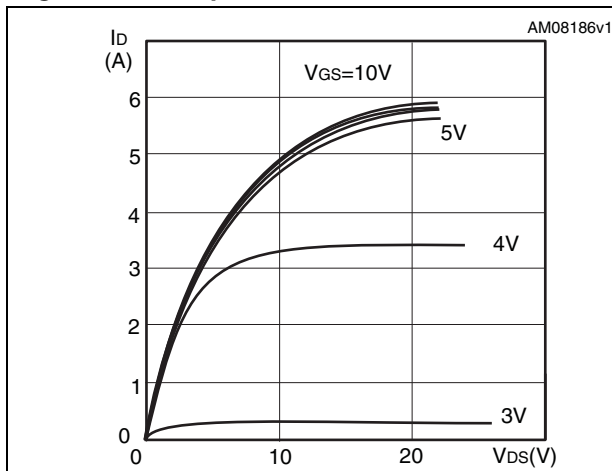

Figure 5. Transfer characteristics

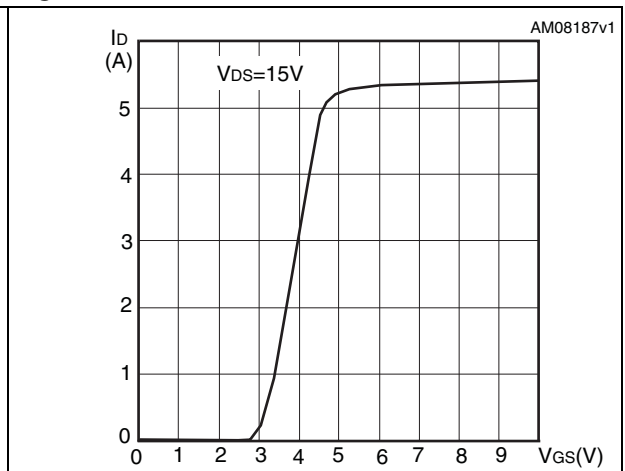

Figure 6. Normalized BV_{DSS} vs temperature

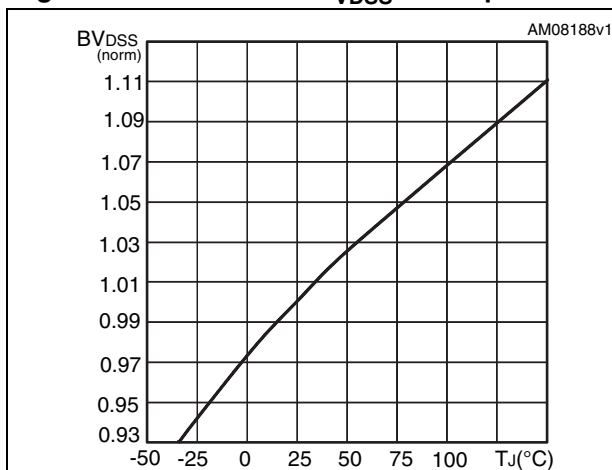

Figure 7. Static drain-source on resistance

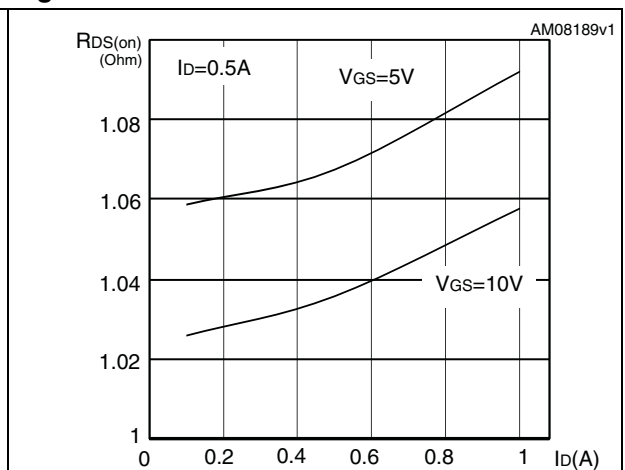

Figure 8. Gate charge vs gate-source voltage Figure 9. Capacitance variations

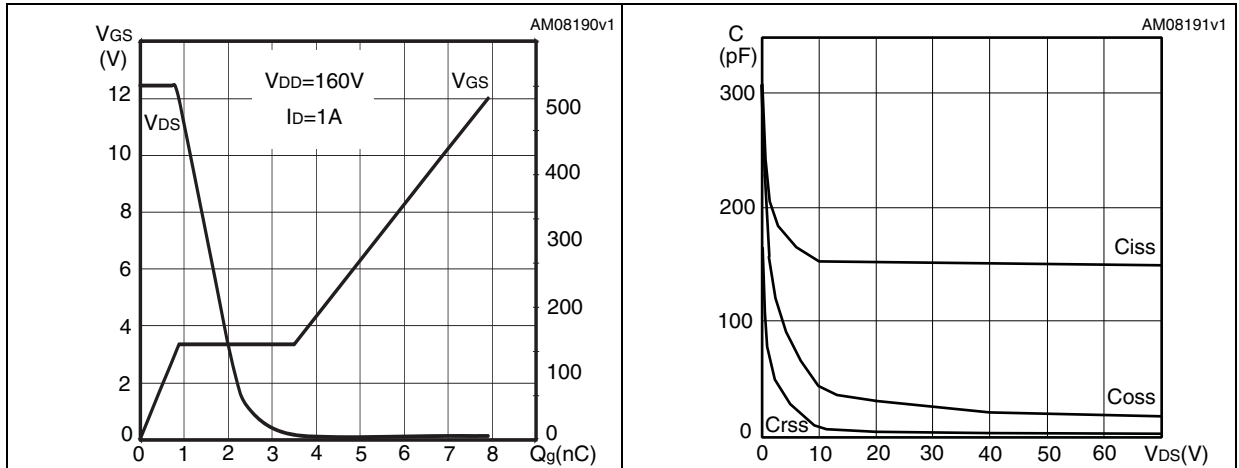
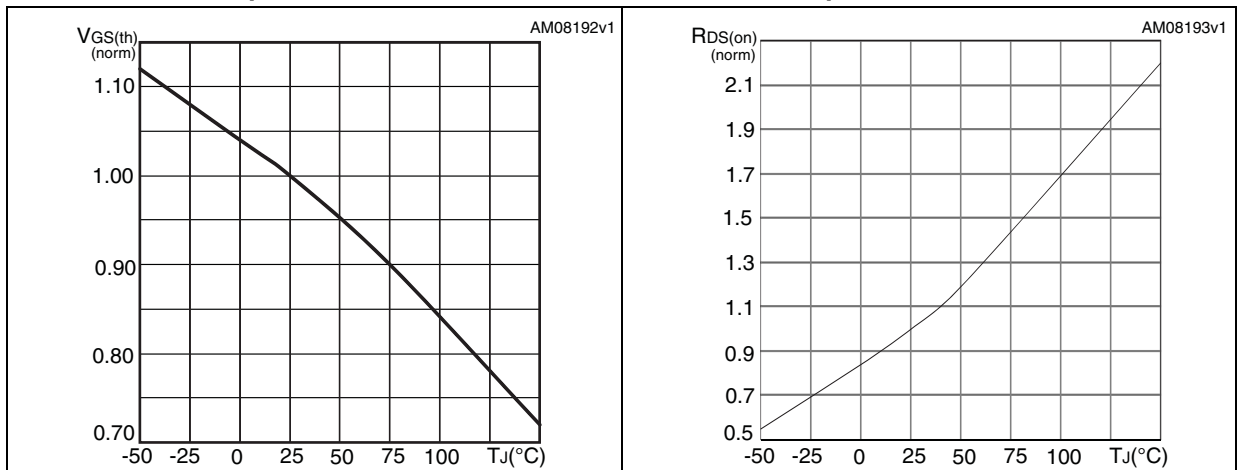

Figure 10. Normalized gate threshold voltage vs temperature Figure 11. Normalized on resistance vs temperature



3 Test circuits

Figure 12. Switching times test circuit for resistive load



Figure 13. Gate charge test circuit



Figure 14. Test circuit for inductive load switching and diode recovery times

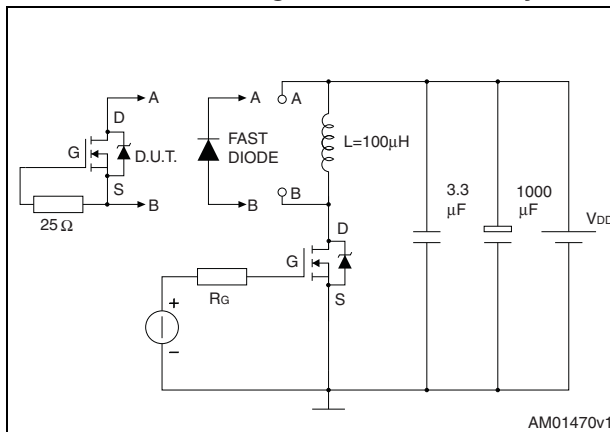

Figure 15. Unclamped inductive load test circuit

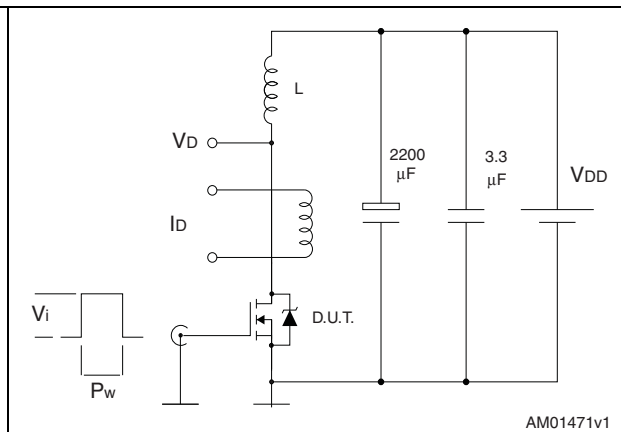

Figure 16. Unclamped inductive waveform

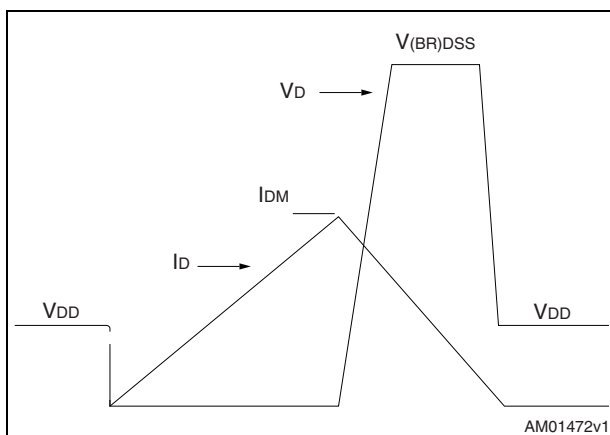
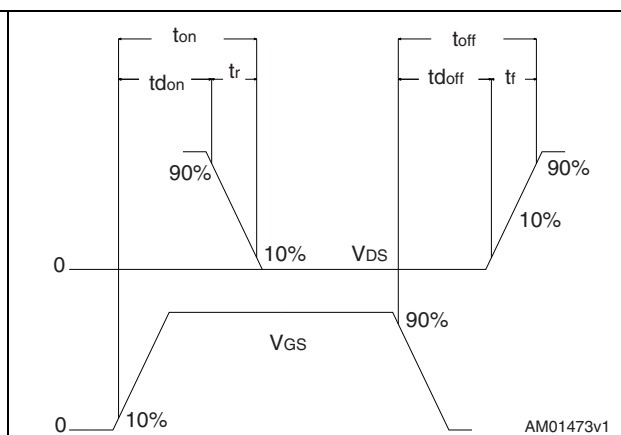

Figure 17. Switching time waveform



4 Package mechanical data

In order to meet environmental requirements, ST offers these devices in different grades of ECOPACK[®] packages, depending on their level of environmental compliance. ECOPACK[®] specifications, grade definitions and product status are available at: www.st.com. ECOPACK is an ST trademark.

SOT-223 mechanical data

DIM.	mm.		
	min.	typ	max.
A			1.80
A1	0.02		0.1
B	0.60	0.70	0.85
B1	2.90	3.00	3.15
c	0.24	0.26	0.35
D	6.30	6.50	6.70
e		2.30	
e1		4.60	
E	3.30	3.50	3.70
H	6.70	7.00	7.30
V			10°

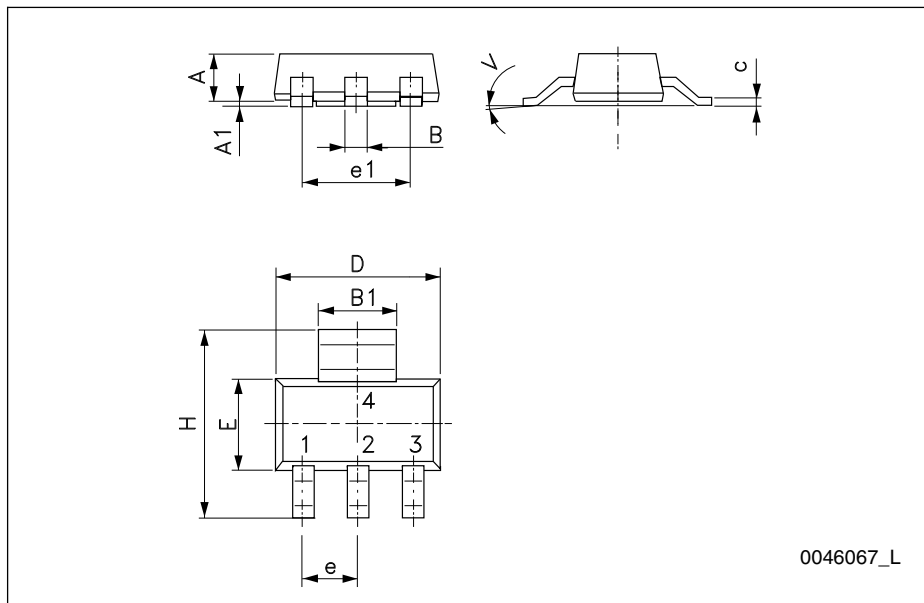

5 Revision history

Table 9. Document revision history

Date	Revision	Changes
29-Apr-2010	1	First release.
11-Oct-2010	2	Document status promoted from preliminary data to datasheet.

Please Read Carefully:

Information in this document is provided solely in connection with ST products. STMicroelectronics NV and its subsidiaries ("ST") reserve the right to make changes, corrections, modifications or improvements, to this document, and the products and services described herein at any time, without notice.

All ST products are sold pursuant to ST's terms and conditions of sale.

Purchasers are solely responsible for the choice, selection and use of the ST products and services described herein, and ST assumes no liability whatsoever relating to the choice, selection or use of the ST products and services described herein.

No license, express or implied, by estoppel or otherwise, to any intellectual property rights is granted under this document. If any part of this document refers to any third party products or services it shall not be deemed a license grant by ST for the use of such third party products or services, or any intellectual property contained therein or considered as a warranty covering the use in any manner whatsoever of such third party products or services or any intellectual property contained therein.

UNLESS OTHERWISE SET FORTH IN ST'S TERMS AND CONDITIONS OF SALE ST DISCLAIMS ANY EXPRESS OR IMPLIED WARRANTY WITH RESPECT TO THE USE AND/OR SALE OF ST PRODUCTS INCLUDING WITHOUT LIMITATION IMPLIED WARRANTIES OF MERCHANTABILITY, FITNESS FOR A PARTICULAR PURPOSE (AND THEIR EQUIVALENTS UNDER THE LAWS OF ANY JURISDICTION), OR INFRINGEMENT OF ANY PATENT, COPYRIGHT OR OTHER INTELLECTUAL PROPERTY RIGHT.

UNLESS EXPRESSLY APPROVED IN WRITING BY AN AUTHORIZED ST REPRESENTATIVE, ST PRODUCTS ARE NOT RECOMMENDED, AUTHORIZED OR WARRANTED FOR USE IN MILITARY, AIR CRAFT, SPACE, LIFE SAVING, OR LIFE SUSTAINING APPLICATIONS, NOR IN PRODUCTS OR SYSTEMS WHERE FAILURE OR MALFUNCTION MAY RESULT IN PERSONAL INJURY, DEATH, OR SEVERE PROPERTY OR ENVIRONMENTAL DAMAGE. ST PRODUCTS WHICH ARE NOT SPECIFIED AS "AUTOMOTIVE GRADE" MAY ONLY BE USED IN AUTOMOTIVE APPLICATIONS AT USER'S OWN RISK.

Resale of ST products with provisions different from the statements and/or technical features set forth in this document shall immediately void any warranty granted by ST for the ST product or service described herein and shall not create or extend in any manner whatsoever, any liability of ST.

ST and the ST logo are trademarks or registered trademarks of ST in various countries.

Information in this document supersedes and replaces all information previously supplied.

The ST logo is a registered trademark of STMicroelectronics. All other names are the property of their respective owners.

© 2010 STMicroelectronics - All rights reserved

STMicroelectronics group of companies

Australia - Belgium - Brazil - Canada - China - Czech Republic - Finland - France - Germany - Hong Kong - India - Israel - Italy - Japan - Malaysia - Malta - Morocco - Philippines - Singapore - Spain - Sweden - Switzerland - United Kingdom - United States of America

www.st.com