

$V_R$	1200V
$I_F$	15A/30A*
$Q_C$	51nC(Per leg)

(\*Per leg/ Both legs)

### ●Features

- 1) Low forward voltage
- 2) Negligible recovery time/current
- 3) Temperature independent switching behavior

### ●Applications

- Switch Mode Power Supply
- Uninterruptible Power Supply
- Solar Inverter
- Motor Drive
- Air Conditioner
- EV Charger

### ●Absolute maximum ratings ( $T_{vj} = 25^\circ\text{C}$ )

Parameter	Symbol	Value	Unit	
Reverse voltage (repetitive peak)	$V_{RM}$	1200	V	
Reverse voltage (DC)	$V_R$	1200	V	
Continuous forward current *3 ( $T_c = 139^\circ\text{C}$ )	$I_F$	15/30	A	
Surge non-repetitive forward current *3	$I_{FSM}$	PW=10ms sinusoidal, $T_{vj}=25^\circ\text{C}$	62/120	A
		PW=10ms sinusoidal, $T_{vj}=150^\circ\text{C}$	46/92	A
		PW=10μs square, $T_{vj}=25^\circ\text{C}$	240/480	A
Repetitive peak forward current *3	$I_{FRM}$	67/130*1	A	
$i^2t$ value *3	$\int i^2 dt$	PW=10ms, $T_{vj}=25^\circ\text{C}$	19/77	$\text{A}^2\text{s}$
		PW=10ms, $T_{vj}=150^\circ\text{C}$	10/42	$\text{A}^2\text{s}$
Total power dissipation *3	$P_D$	180/360*2	W	
Virtual Junction temperature	$T_{vj}$	175	$^\circ\text{C}$	
Range of storage temperature	$T_{stg}$	-55 to +175	$^\circ\text{C}$	

\*1  $T_c=100^\circ\text{C}$ ,  $T_{vj}=150^\circ\text{C}$ , Duty cycle=10% \*2  $T_c=25^\circ\text{C}$  \*3 Per leg/ Both legs

### ●Outline

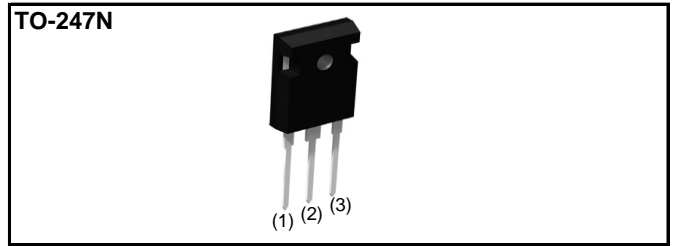

### ●Inner circuit

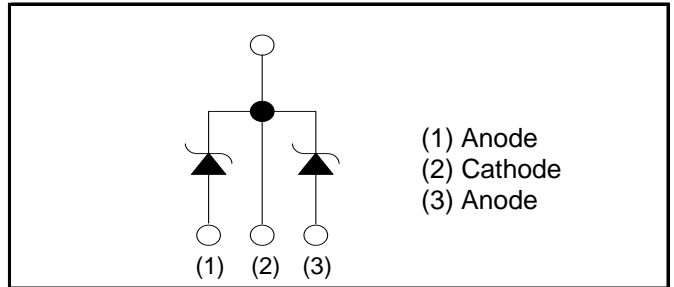

### ●Packaging specifications

Package	TO-247N	
Type	Packing	Tube
	Reel size (mm)	-
	Tape width (mm)	-
	Basic ordering unit (pcs)	30
	Packing code	C11
	Marking	SCS230KE2

**●Electrical characteristics ( $T_{vj} = 25^{\circ}\text{C}$ ) (Per Leg)**

Parameter	Symbol	Conditions	Values			Unit
			Min.	Typ.	Max.	
DC blocking voltage	$V_{DC}$	$I_R=0.3\text{mA}$	1200	-	-	V
Forward voltage	$V_F$	$I_F=15\text{A}, T_{vj}=25^{\circ}\text{C}$	-	1.4	1.6	V
		$I_F=15\text{A}, T_{vj}=150^{\circ}\text{C}$	-	1.8	-	V
		$I_F=15\text{A}, T_{vj}=175^{\circ}\text{C}$	-	1.9	-	V
Reverse current	$I_R$	$V_R=1200\text{V}, T_{vj}=25^{\circ}\text{C}$	-	15	300	$\mu\text{A}$
		$V_R=1200\text{V}, T_{vj}=150^{\circ}\text{C}$	-	120	-	$\mu\text{A}$
		$V_R=1200\text{V}, T_{vj}=175^{\circ}\text{C}$	-	195	-	$\mu\text{A}$
Total capacitance	C	$V_R=1\text{V}, f=1\text{MHz}$	-	790	-	pF
		$V_R=600\text{V}, f=1\text{MHz}$	-	64	-	pF
Total capacitive charge	$Q_C$	$V_R=800\text{V}, di/dt=500\text{A}/\mu\text{s}$	-	51	-	nC
Switching time	$t_C$	$V_R=800\text{V}, di/dt=500\text{A}/\mu\text{s}$	-	18	-	ns

**●Thermal characteristics**

Parameter	Symbol	Conditions	Values			Unit
			Min.	Typ.	Max.	
Thermal resistance	$R_{thJC}$	Per Leg	-	0.67	0.81	K/W
		Both Legs	-	0.34	0.41	K/W

**●Typical Transient Thermal Characteristics (Per Leg)**

Symbol	Value	Unit	Symbol	Value	Unit
$R_{th1}$	$1.25 \times 10^{-1}$	K/W	$C_{th1}$	$3.81 \times 10^{-3}$	Ws/K
$R_{th2}$	$4.03 \times 10^{-1}$		$C_{th2}$	$4.54 \times 10^{-3}$	
$R_{th3}$	$1.43 \times 10^{-1}$		$C_{th3}$	$7.59 \times 10^{-2}$	

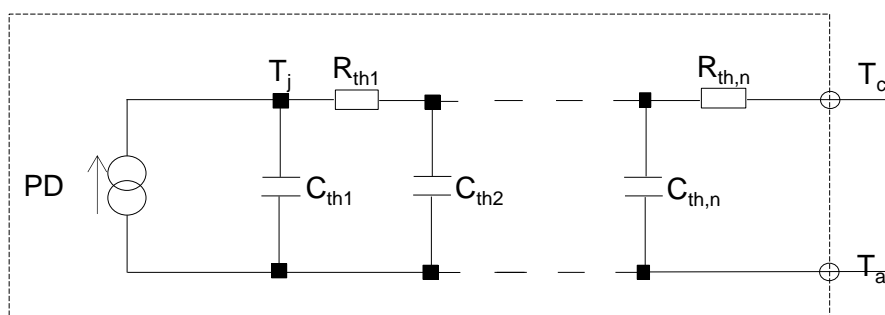

●Electrical characteristic curves

Fig.1  $V_F - I_F$  Characteristics (Per Leg)

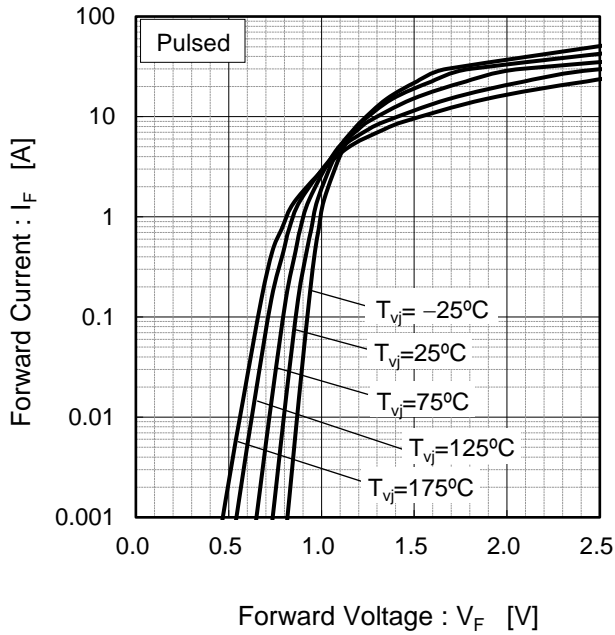

Fig.2  $V_F - I_F$  Characteristics (Per Leg)

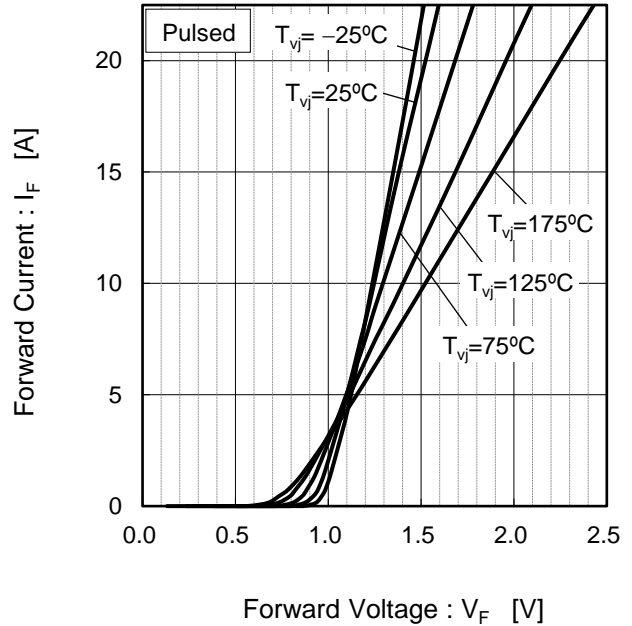

Fig.3  $V_R - I_R$  Characteristics (Per Leg)

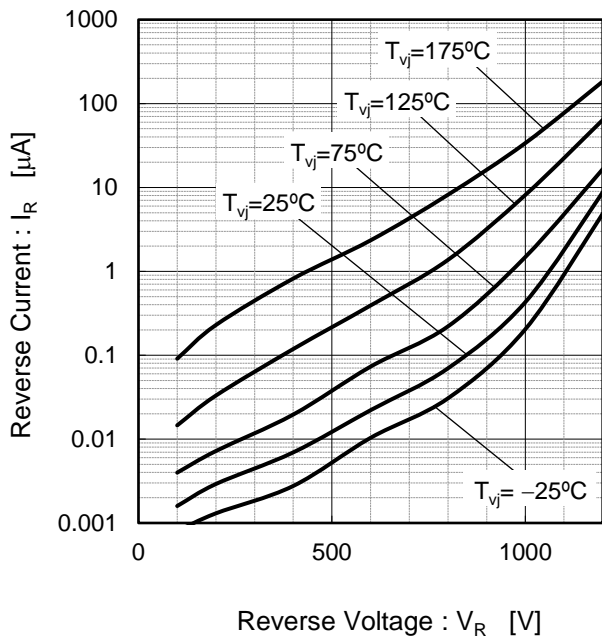
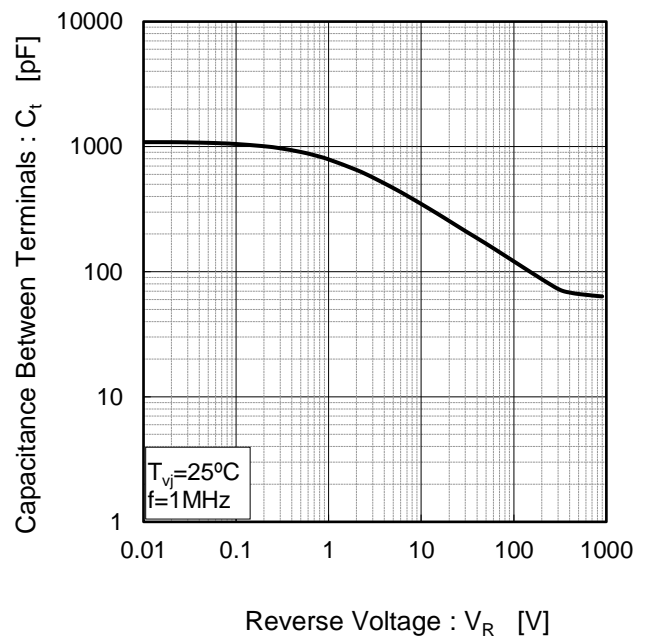

Fig.4  $V_R - C_t$  Characteristics (Per Leg)



●Electrical characteristic curves

Fig.5 Typical Transient Thermal Impedance vs. Pulse Width (Per Leg)

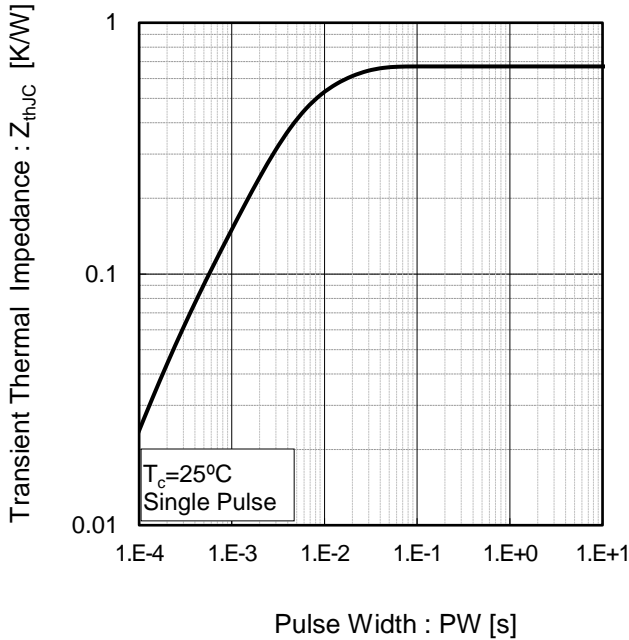

Fig.6 Power Dissipation (Per Leg)

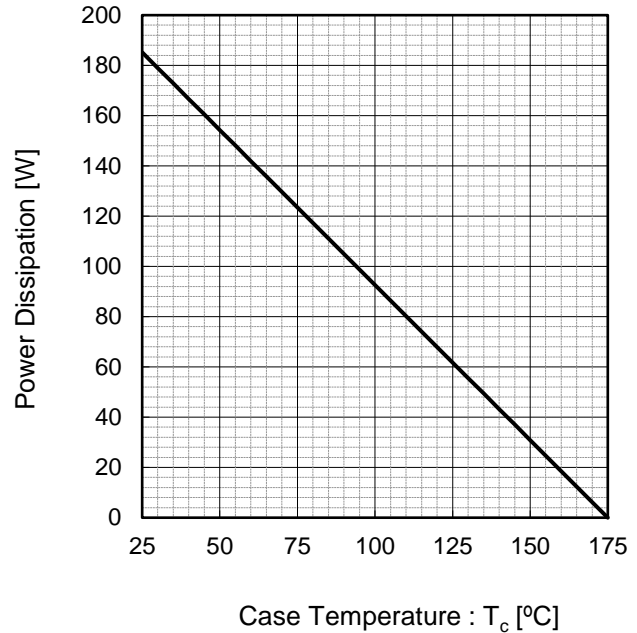
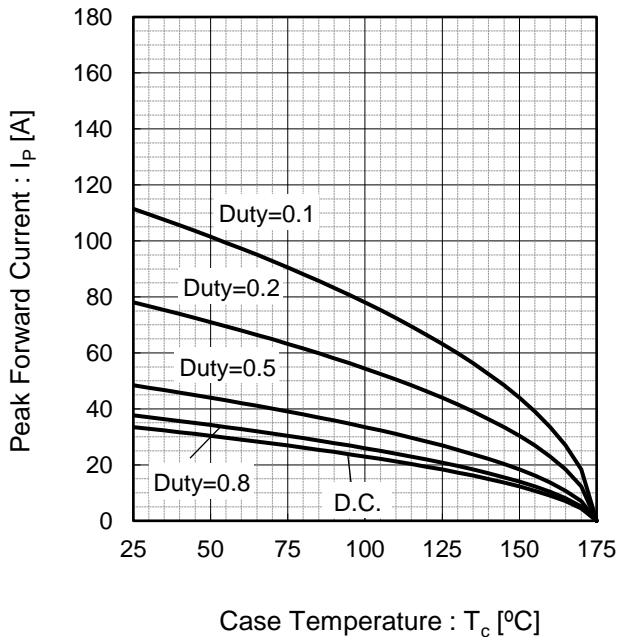
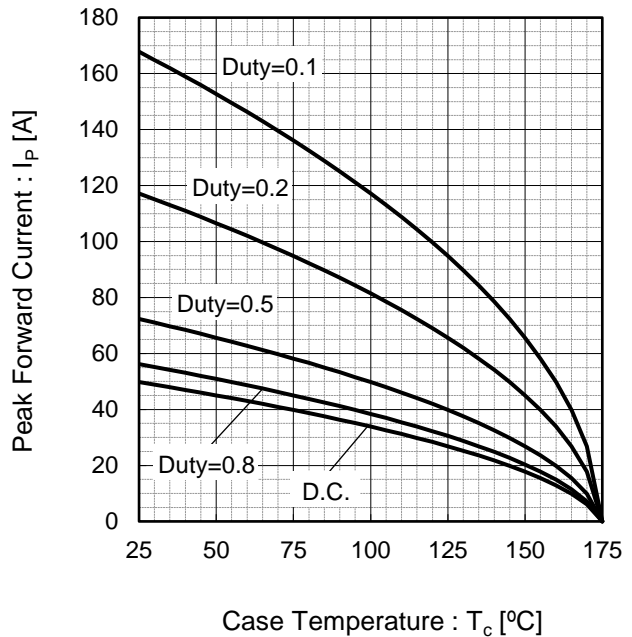

Fig.7\*3 Maximum peak forward current derating curve  $I_P - T_C$  (Per Leg)



\*4 Based on max Vf, max  $R_{thJC}$   
Valid for switching of above 10kHz,  
excluding D.C. curve.

Fig.8\*4 Typical peak forward current derating curve  $I_P - T_C$  (Per Leg, Not guaranteed)



\*5 Based on typ Vf, typ  $R_{thJC}$   
Typical value, not guaranteed  
Valid for switching of above 10kHz,  
excluding D.C. curve

●Electrical characteristic curves

Fig.9 Surge non-repetitive forward current vs. Pulse width (Sinusoidal waveform) (Per Leg)

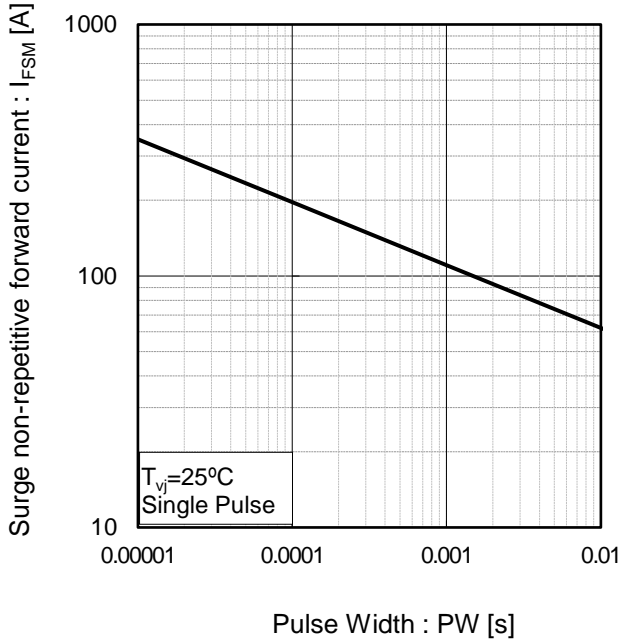
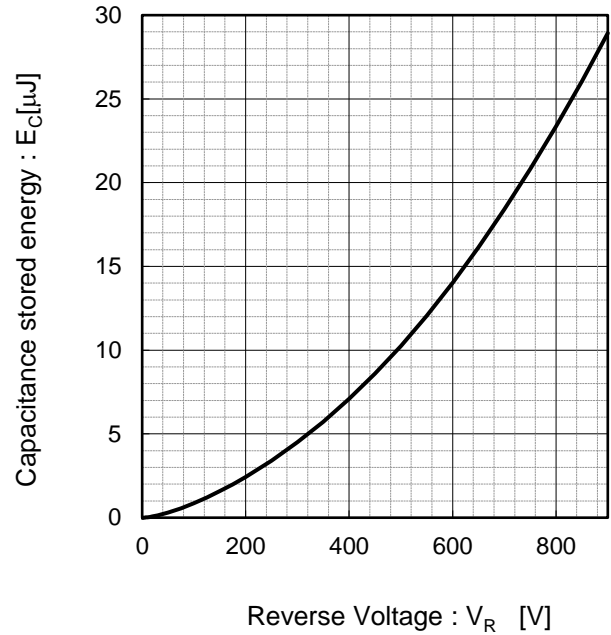
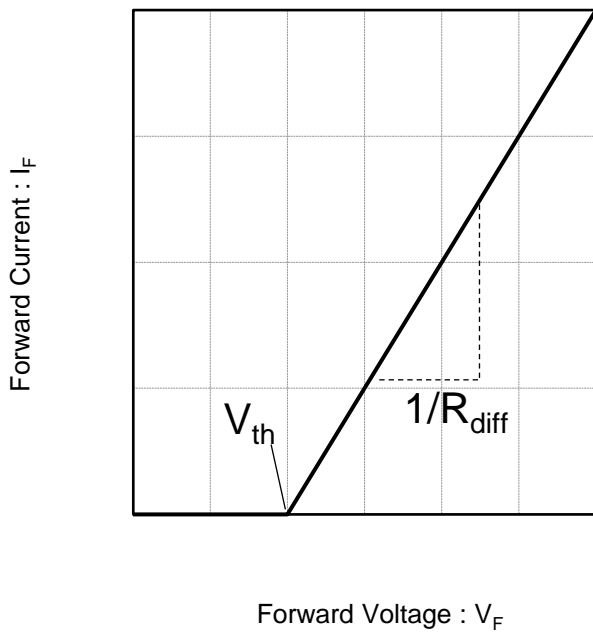

Fig.10 Typical capacitance store energy (Per Leg)



●Simplified forward characteristic model (Per Leg)

Fig.11 Equivalent forward current curve



$$V_F = V_{th} + R_{diff} I_F$$

$$V_{th}(T_{vj}) = a_0 + a_1 T_{vj}$$

$$R_{diff}(T_{vj}) = b_0 + b_1 T_{vj} + b_2 T_{vj}^2$$

Symbol	Typical Value	Unit
$a_0$	$9.93 \times 10^{-1}$	V
$a_1$	$-1.27 \times 10^{-3}$	V/°C
$b_0$	$2.43 \times 10^{-2}$	Ω
$b_1$	$1.37 \times 10^{-4}$	Ω/°C
$b_2$	$8.87 \times 10^{-7}$	Ω/°C <sup>2</sup>

$T_{vj}$  in °C;  $-55\text{ °C} < T_{vj} < 175\text{ °C}$ ;  $I_F < 30\text{ A}$

## ● Package Dimensions

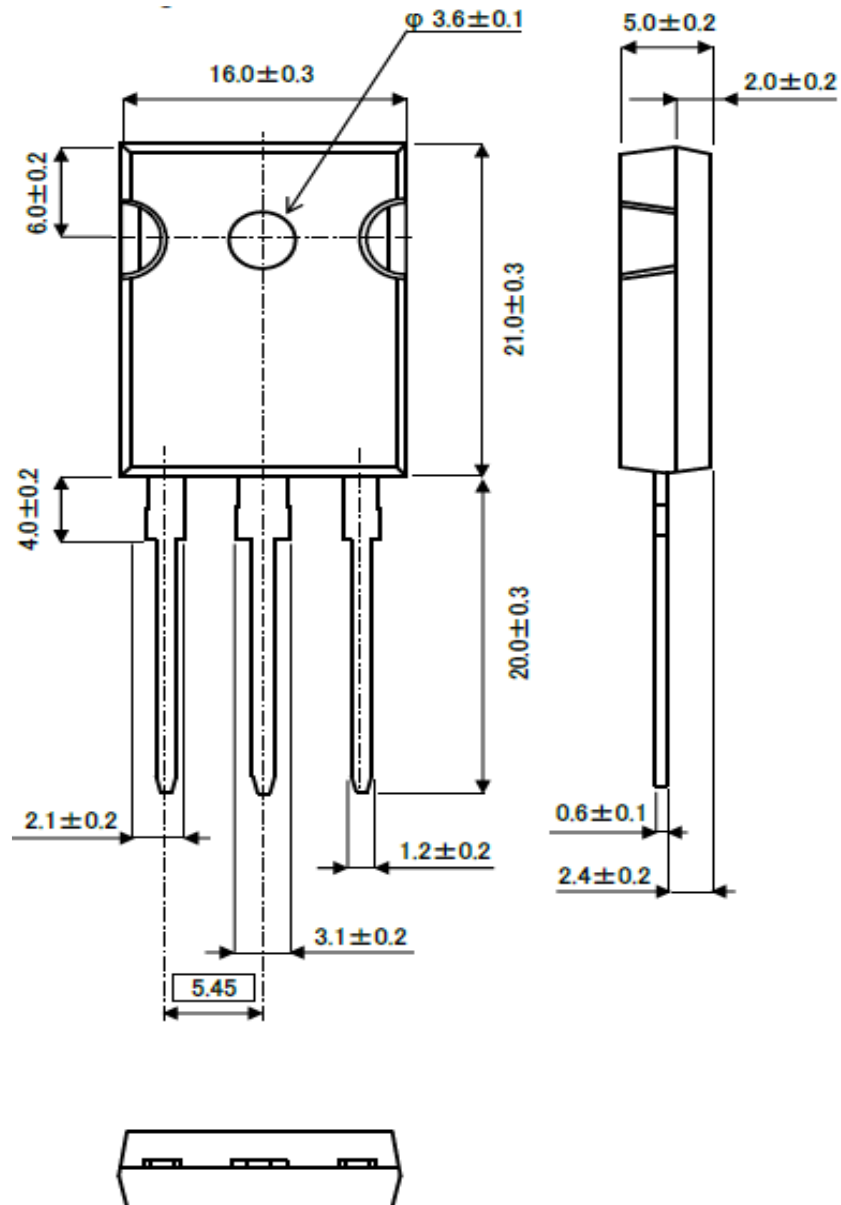

Unit: mm

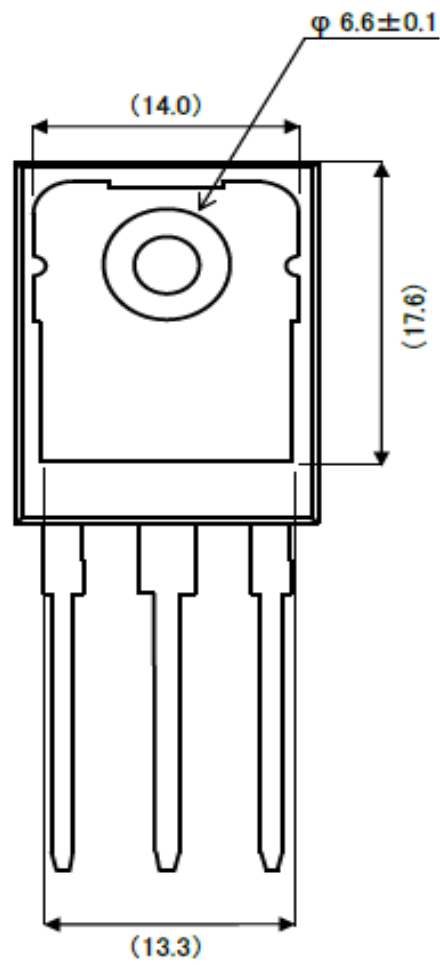

Unit: mm

## ●Die Bonding Layout

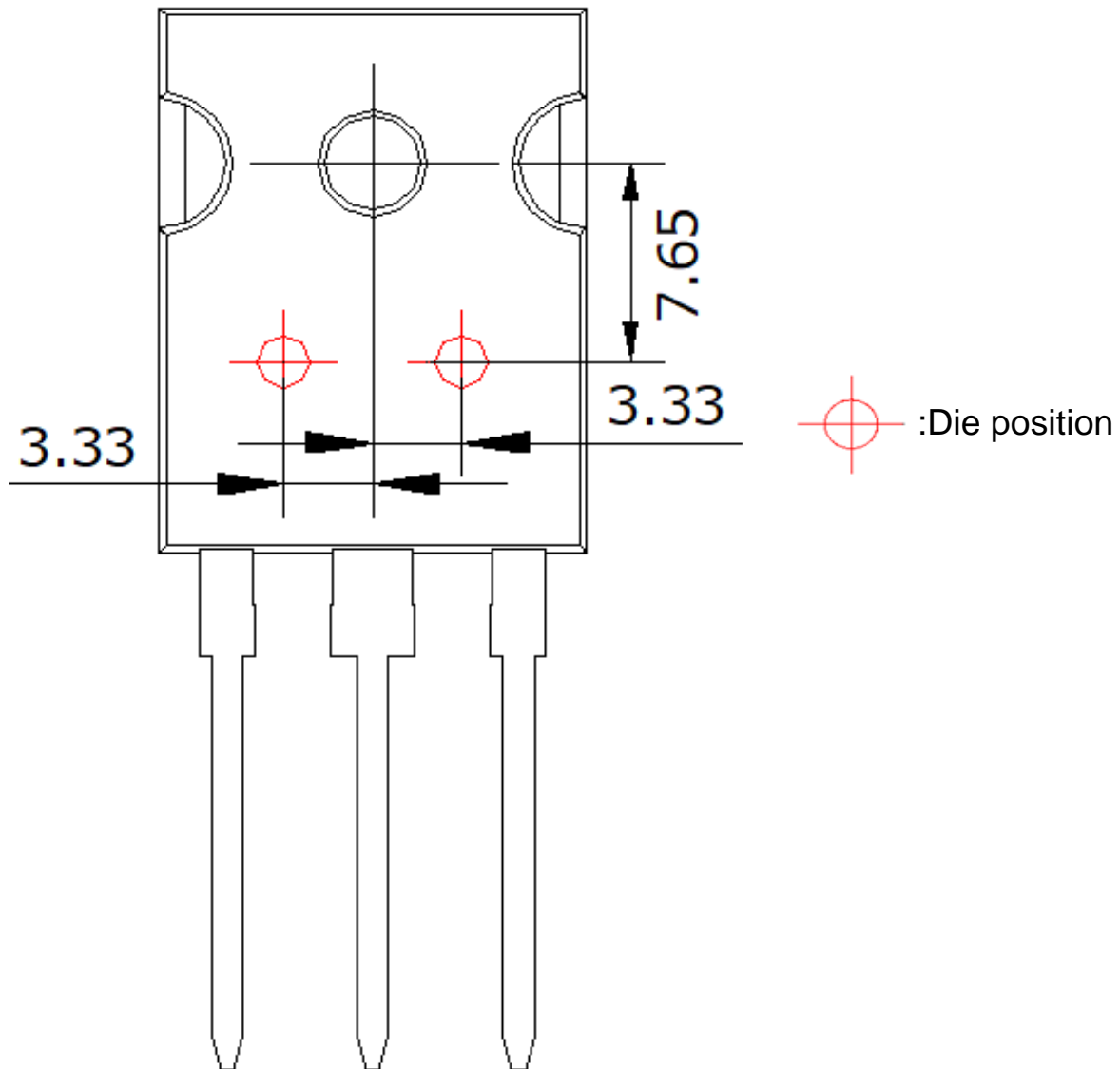

- Front view of the packaging.
- Dimensions are design values.
- If the heat sink is to be installed, it should be in contact with the die bonding point.

Unit: mm