

New

# TF037-1001-D

## DRIVERS

Dedicated to the Micro Blower TF037 series.  
 The drivers enable users to vary the speed of the motor by adjusting the control voltage of the external input.  
 Contents of the kit are Driver board and Harness (2 types).  
 Wire Harness: for Driver-Blower connection  
 for Driver-Power connection

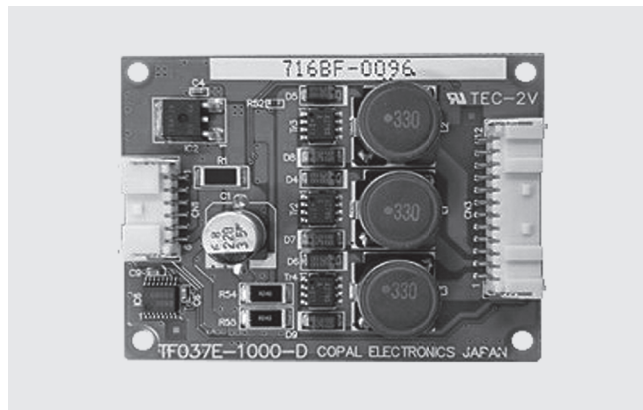

## STANDARD SPECIFICATIONS

● Unless otherwise specified, the environmental conditions are 23°C±5°C, normal humidity, and atmospheric pressure range 90 to 106kPa.

No.	Item	Specification		
1	Configuration	Drivers(Dedicated to the Micro Blower TF037 series)		
2	Rotational Speed	40,000 r/min (reference value) at 4.0kPa, 100L/min		
3	Power Consumption	29W max. at 4.0kPa, 100L/min		
4	Rated Voltage	DC 24 V±10%		
5	Max. Input Current	2.0 A max.(DC) 4.0 A max.(Pulse) (Excluding inrush current)		
6	Running Current	1.2 A max. at 4.0kPa, 100L/min		
7	Weight	32 g max.		
8	Operating Temperature	-10~ 50 °C		
9	Operating Humidity Range	10~ 90 %RH (No condensation)		
10	Storage Temperature	-20~ 60 °C		
11	Storage Humidity Range	10~ 90 %RH (No condensation)		
12	Resistance to Vibration	To meet the Spec after the following test		Non-operating
		Kind of Vibration	Sweep	
		Frequency Range	10 ~ 22Hz amplitude 1mm	
			22 ~ 50Hz 19.6m/s <sup>2</sup> (2G) (acceleration)	
		Sweep	to-and-fro, approx. 5min.	
Test Time	X, Y, Z directions, 60min. each			
13	Resistance to Shock	To meet the Spec after the following test		Non-operating
		Acceleration	294m/s <sup>2</sup> (30G)	
		Pulse Width	6ms	
		Shock Waven	Semi-sinusoidal wave	
		Number of Shock	X, Y, Z, directions, once per each direction	

# TF037-1001-D

## MICRO BLOWER DRIVERS

### INTERFACE

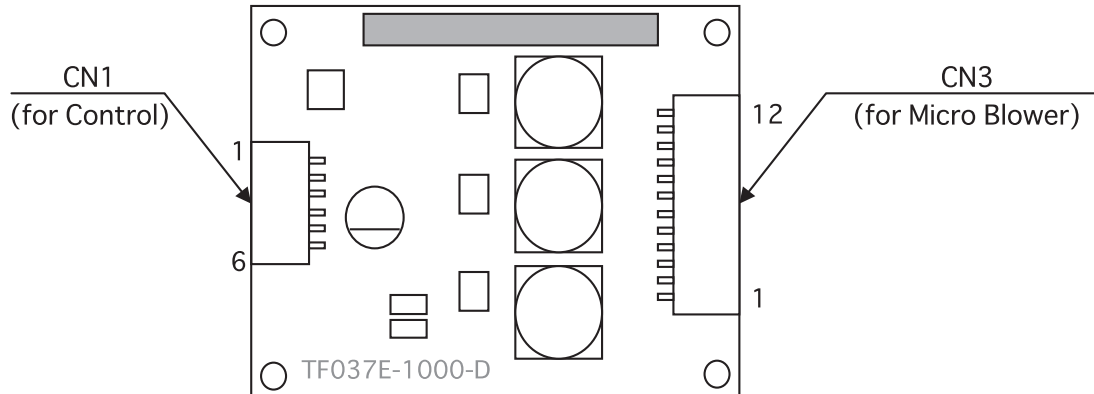

【CN1 : Connector for Control】

Manufacturer	J.S.T. Mfg. Co., Ltd.
Part No.	SM06B-PASS

Pin No.	Symbol	Signal
1	Error	Error Output
2	FG	Rotational Speed Signal Output (FG)
3	BR	Short brake Input
4	CNT	Control Voltage Input
5	Vcc	Power Supply Voltage Input
6	GND	GND

【CN3 : Connector for Micro Blower】

Manufacturer	J.S.T. Mfg. Co., Ltd.
Part No.	SM12B-PASS

Pin No.	Symbol	Signal
1	U	(U) Motor Coil
2	W	(W) Motor Coil
3	V	(V) Motor Coil
4	TH	Thermistor Input
5	GND	GND
6	H1+	Hall Element 1 Input
7	H1-	
8	H3+	Hall Element 3 Input
9	H3-	
10	H2+	Hall Element 2 Input
11	H2-	
12	Vcc	(+12V) Hall Element Power

# TF037-1001-D

## MICRO BLOWER DRIVERS

### ■ CN1(CONNECTOR FOR CONTROL)SPECIFICATIONS

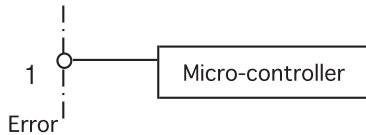
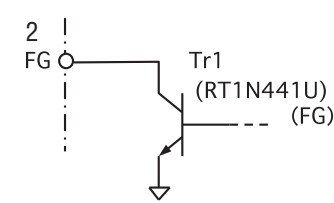
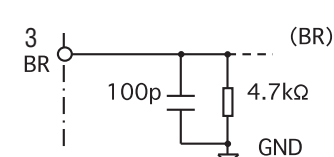
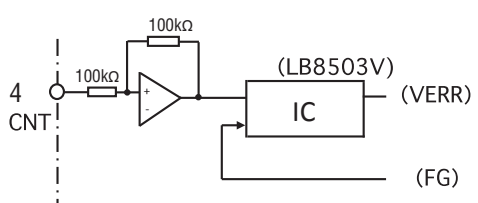
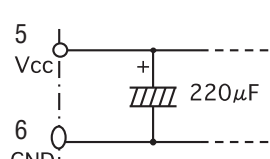
Pin No.	Symbol	Specification	
1	Error	Error Output L = Undetected H = Detection	
2	FG	Rotational Speed Signal Output(FG) 12 pulse / rev. Open Collector Output Max. Voltage : 50V Max. Output Current : 3mA	<Driver side> 
3	BR	Short brake Input L=Rotation H=Short brake	<Driver side> 
4	CNT	Control Voltage Input <div style="border: 1px solid black; padding: 5px; width: fit-content;">             Input Voltage for Standby:0V              Input Voltage for Operation:1.0 to 5.0V           </div>	<Driver side> 
5	Vcc	Power Supply Voltage Input DC24V±10%	
6	GND	GND	

# TF037-1001-D MICRO BLOWER DRIVERS

## PROTECTIVE FUNCTIONS

Attached Driver Board is featured with the following protective functions.

Protective Functions	Description
High Temperature	Power will be turned off when the thermistor inside the Blower exceeds 86°C.
High rotational	Power will be turned off when the rotational speed exceeds 45,000 r/min.
Overcurrent	Power will be turned off when the coil current exceeds 1.9A (except start-up).
Motor Lock 1	Power will be turned off when coil current and rotational speed are in the "Motor Lock Protection Area" shown in Graph 2 below.
Motor Lock 2	Power will be turned off when the Blower does not operate even when the PRODUCT is giving command to operate.

## PROTECTIVE AREA

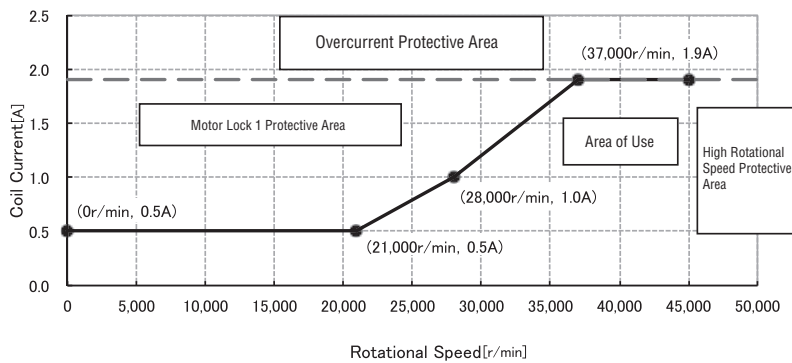

### 【Monitor / Control Flow】

Monitored Items	Protective Functions	Criteria	Control
CNT V 1.0 ~ 5.0V			
Thermistor temperature	High Temperature	Thermistor 86°C or higher	Blower Stop
Rotational speed	High Rotational	45,000r/min or higher	
Coil current	Overcurrent	Shunt resistant current 1.9A or higher	
	Motor Lock 1	Motor Lock 1 Protective Area	
	Motor Lock 2	Rotation failure of Blower	

《Restart Conditions After Blower Stop》 Restart with turning the power on again.

# TF037-1001-D

## MICRO BLOWER DRIVERS

### OUTLINE DIMENSIONS

Unless otherwise specified, tolerance :  $\pm 0.5$ (Unit: mm)

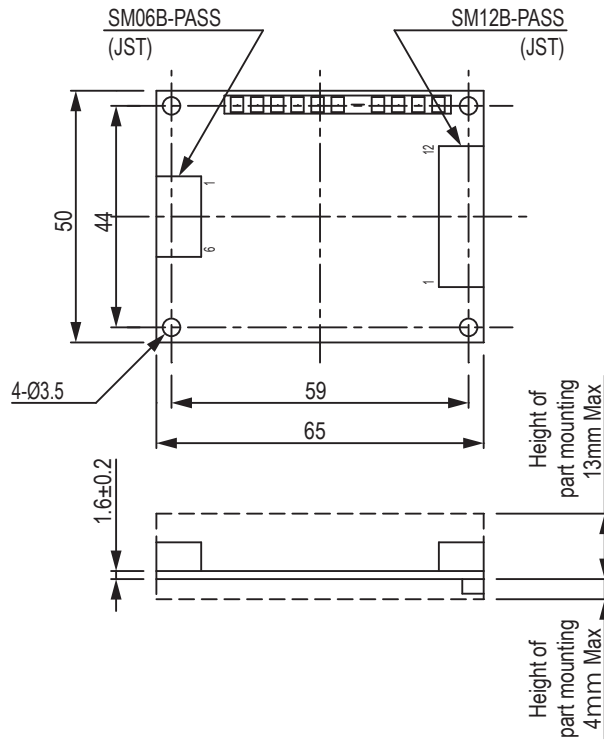

### MARKING

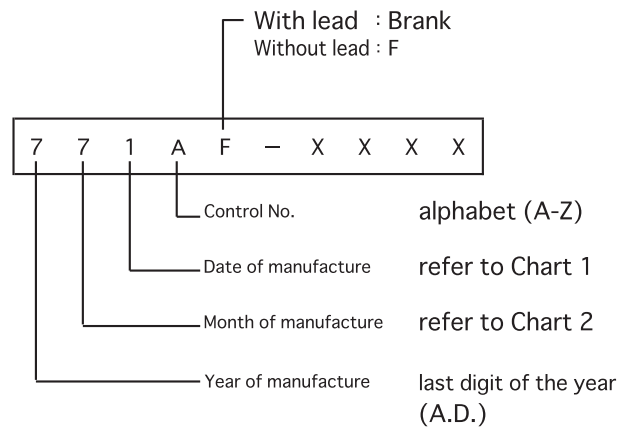
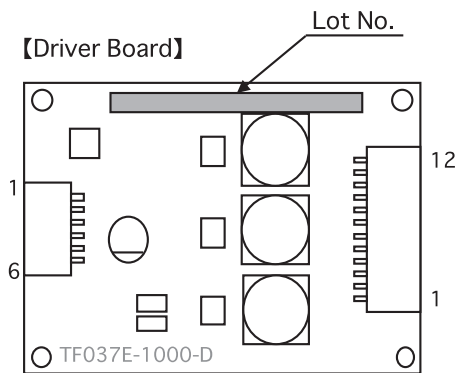

【Chart 1】

Date	1	2	3	4	5	6	7	8	9	10	11	12	13	14	15	16	17	18	19	20
Code	1	2	3	4	5	6	7	8	9	A	B	C	D	E	F	G	H	J	K	L

Date	21	22	23	24	25	26	27	28	29	30	31
Code	M	N	P	Q	R	T	U	V	W	X	Y

【Chart 2】

month	1	2	3	4	5	6	7	8	9	10	11	12
Code	1	2	3	4	5	6	7	8	9	0	N	D